



BE2000E

Digital Voltage Regulator

Instruction Manual

 **WARNING:** California's Proposition 65 requires special warnings for products that may contain chemicals known to the state of California to cause cancer, birth defects or other reproductive harm. Please note that by posting this Proposition 65 warning, we are notifying you that one or more of the Proposition 65 listed chemicals may be present in products we sell to you. For more information about the specific chemicals found in this product, please visit <https://www.basler.com/Prop65>.

Preface

This instruction manual provides information about the installation and operation of the BE2000E. To accomplish this, the following information is provided:

- General information
- Human-machine interface (HMI)
- Functional description
- Installation
- BESTCOMS™ software
- Maintenance and troubleshooting
- Specifications

Conventions Used in this Manual

Important safety and procedural information is emphasized and presented in this manual through warning, caution, and note boxes. Each type is illustrated and defined as follows.

Warning!

Warning boxes call attention to conditions or actions that may cause personal injury or death.

Caution

Caution boxes call attention to operating conditions that may lead to equipment or property damage.

Note

Note boxes emphasize important information pertaining to installation or operation.



12570 State Route 143
Highland IL 62249-1074 USA

www.basler.com

info@basler.com

Tel: +1 618.654.2341

Fax: +1 618.654.2351

© 2023 by Basler Electric

All rights reserved

First printing: May 2011

Warning!

READ THIS MANUAL. Read this manual before installing, operating, or maintaining this equipment. Note all warnings, cautions, and notes in this manual as well as on the product. Keep this manual with the product for reference. Only qualified personnel should install, operate, or service this system. Failure to follow warning and cautionary labels may result in personal injury or property damage. Exercise caution at all times.

Caution

Installing previous versions of firmware may result in compatibility issues causing the inability to operate properly and may not have the enhancements and resolutions to issues that more recent versions provide. Basler Electric highly recommends using the latest version of firmware at all times. Using previous versions of firmware is at the user's risk and may void the warranty of the unit.

Basler Electric does not assume any responsibility to compliance or noncompliance with national code, local code, or any other applicable code. This manual serves as reference material that must be well understood prior to installation, operation, or maintenance.

For terms of service relating to this product and software, see the *Commercial Terms of Products and Services* document available at www.basler.com/terms.

This publication contains confidential information of Basler Electric Company, an Illinois corporation. It is loaned for confidential use, subject to return on request, and with the mutual understanding that it will not be used in any manner detrimental to the interests of Basler Electric Company and used strictly for the purpose intended.

It is not the intention of this manual to cover all details and variations in equipment, nor does this manual provide data for every possible contingency regarding installation or operation. The availability and design of all features and options are subject to modification without notice. Over time, improvements and revisions may be made to this publication. Before performing any of the following procedures, contact Basler Electric for the latest revision of this manual.

The English-language version of this manual serves as the only approved manual version.

Revision History

A historical summary of the changes made to BESTCOMS™ software and this instruction manual is provided below. Revisions are listed in reverse chronological order.

Visit <http://www.basler.com> to download the latest hardware, firmware, and BESTCOMSPlus® revision histories.

BESTCOMS Software Revision History

Software Version and Date	Change
2.02.01, Dec 2016	<ul style="list-style-type: none"> Added Windows® compatibility Improved firmware uploader Improved settings download
2.01.00, Oct 2014	<ul style="list-style-type: none"> Added 52 JK function settings and metering Added Windows® 8 compatibility
2.00.00, Apr 2011	<ul style="list-style-type: none"> Initial release

Instruction Manual Revision History

Manual Revision and Date	Change
E, Dec 2023	<ul style="list-style-type: none"> Added China RoHS compliance
D, Oct 2021	<ul style="list-style-type: none"> Added EAC certification Relocated <i>Revision History</i> chapter content Updated manual format and numbering style
C2, Apr 2019	<ul style="list-style-type: none"> Revised wording of California Proposition 65 warning statement
C1, Nov 2018	<ul style="list-style-type: none"> Added California Proposition 65 warning statement
C, Jul 2017	<ul style="list-style-type: none"> Added caution statement about nonvolatile memory Added part number for fuse F1 Updated EC Directives under <i>CE Compliance</i> Minor text edits throughout manual
B, Dec 2014	<ul style="list-style-type: none"> Added settings and metering descriptions for the 52JK function settings in the <i>BESTCOMS Software</i> chapter Added CE, CSA, and UL to the <i>Specifications</i> chapter Moved Revision History into a new chapter Moved Specifications to a new chapter
A, Nov 2012	<ul style="list-style-type: none"> Corrected operating power frequency range and burden in the <i>General Specifications</i> chapter Added Storage statement in the <i>Installation</i> chapter Converted manual into new style and structure
—, May 2011	<ul style="list-style-type: none"> Initial release



Contents

General Information	1-1
Human-Machine Interface	2-1
Functional Description.....	3-1
Installation.....	4-1
BESTCOMS™ Software	5-1
Maintenance and Troubleshooting	6-1
Specifications.....	7-1



1 • General Information

The BE2000E is an electronic, solid-state, microprocessor-based control device. The BE2000E regulates the output voltage of a brushless, ac generator by controlling the current into the generator exciter field. Input power to the BE2000E is from a multi-pole, high-frequency, permanent magnet generator (PMG).

The BE2000E is supplied in an encapsulated package designed for behind-the-panel mounting. The BE2000E is held in place by thread-forming screws that thread into its plastic shell. Front panel indicators (LEDs) annunciate regulator status and system conditions. BE2000E connections are made through quarter-inch, quick-connect terminals on the rear panel. A nine-pin DB-9 type connector on the rear panel provides communication between the BE2000E and an IBM compatible PC.

Features

BE2000E units have the following features and capabilities:

- Four control modes: automatic voltage regulation (AVR), manual or field current regulation (FCR), power factor (PF) regulation, and reactive power (var) regulation.
- Programmable stability settings.
- Soft start control with an adjustable time setting in AVR control mode.
- Overexcitation (OEL) limiting in AVR, var, and PF control modes.
- Underfrequency (volts/hertz) regulation.
- Crowbar circuitry protects the field.
- Overtemperature protection.
- Three-phase or single-phase generator voltage (RMS) sensing/regulation in AVR mode.
- Single-phase generator current sensing for metering and regulation purposes.
- Field current and field voltage sensing.
- Four contact sensing inputs for system interface.
- One common output relay for alarm indication and trip functions.
- Six protection functions (overexcitation shutdown, generator overvoltage shutdown, BE2000E overtemperature shutdown, loss of generator sensing shutdown, overexcitation limiting and crowbar shutdown).
- Generator paralleling with reactive droop compensation and reactive differential compensation.
- Front-panel human-machine interface (HMI) indicates system and BE2000E status and gives the ability to make setting changes at the front panel.
- Rear RS-232 communication port for personal computer communication using BESTCOMS™-BE2000E Windows® based software for fast, user-friendly, setup and control.



2 • Human-Machine Interface

The BE2000E Human-Machine Interface (HMI) consists of front panel controls and indicators and a rear panel communication port.

Front Panel Controls and Indicators

BE2000E front panel controls and indicators consist of 12 red LEDs and three pushbuttons. Figure 2-1 illustrates the front panel controls and indicators of the BE2000E. The LEDs indicate control mode and status conditions and are also used when adjusting settings at the front panel.

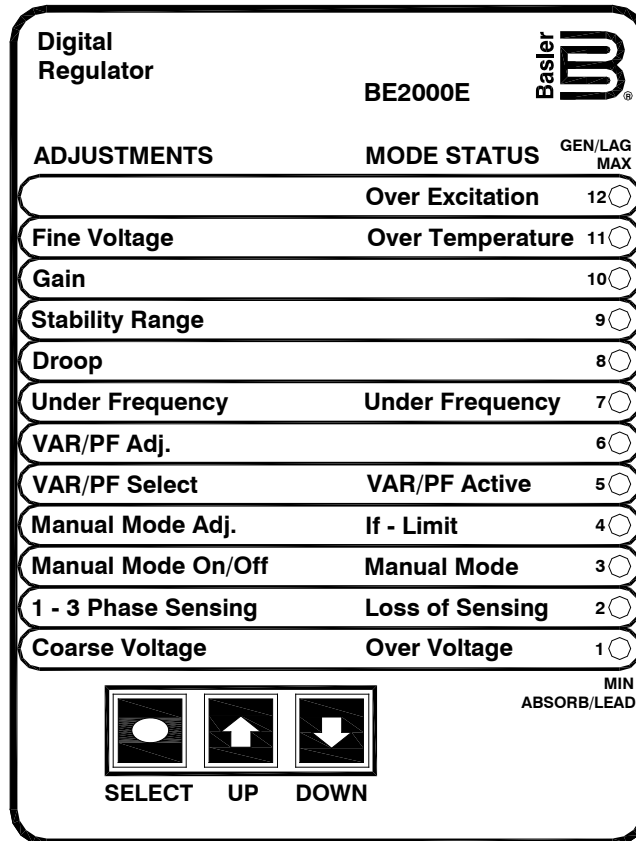

Figure 2-1. BE2000E Front Panel Indicators

Table 2-1. BE2000E Front Panel Control Descriptions

Control	Description
SELECT	This pushbutton selects a function for adjustment. Successive presses of the SELECT pushbutton scrolls through the list of BE2000E functions to be adjusted.
UP	This pushbutton increases the setting level of the function being adjusted.
DOWN	This pushbutton decreases the setting level of the function being adjusted.

Table 2-2. BE2000E Front Panel Mode Status Indicator Descriptions

Indicator	Description
Over Excitation LED #12	This LED blinks rapidly when the Overexcitation Protection feature is enabled and the field voltage exceeds the setpoint (80 V default) for 15 seconds. The BE2000E will shut down when an overexcitation condition is detected. The Over Excitation LED blinks for 5 seconds when the BE2000E is powered up following an overexcitation condition.
Over Temperature LED #11	This LED blinks rapidly when the internal temperature of the BE2000E has exceeded its limit and causes the unit to shut down.
Under Frequency LED #7	This LED blinks rapidly during an under frequency condition.
Var/PF Active LED #5	This LED blinks rapidly when operating in Var or Power Factor mode.
If – Limit LED #4	This LED blinks rapidly when the field current exceeds the programmed overexcitation limit. It will continue to flash until the overexcitation condition ceases or the overexcitation time delay expires and the BE2000E shuts down. The Overexcitation Limiting LED flashes for 5 seconds when the BE2000E is powered up following an overexcitation limiting condition.
Manual Mode LED #3	This LED blinks rapidly when operating in Manual mode.
Loss of Sensing LED #2	This LED blinks rapidly when a loss of generator sensing voltage is detected. The BE2000E will shut down. The Loss of (Generator) Sensing LED flashes for 5 seconds when the BE2000E is powered up following shutdown for loss of generator sensing condition.
Over Voltage LED #1	This LED blinks rapidly when the generator output voltage exceeds the setpoint for 0.75 seconds. The BE2000E will shut down when a generator overvoltage condition is detected. The (Generator) Overvoltage LED flashes for 5 seconds when the BE2000E is powered up following a generator overvoltage condition.

Caution

Read and understand the operation of the individual adjustments before attempting any initial adjustments.

Initial Adjustments

Before starting the generator, the procedures in the following paragraphs should be performed.

Remove the 5-ampere fuse before starting the generator for the first time. Perform all preliminary engine governor adjustments without the regulator energized.

After initial governor adjustments are complete, reinstall the 5-ampere fuse, and connect only the power input leads or PMG leads to the regulator. Remove all other regulator connections that may be present and temporarily insulate them.

Start and run the generator at rated speed. The regulator will perform the self-test and enter a shutdown mode. At this time, initial adjustments can be made. To do this, step through each adjustment using the “SELECT” button. For each adjustment, press the “UP” or “DOWN” button to obtain the desired level on the LED bar graph.

After the initial adjustments are made, shut down the generator and connect the remaining regulator leads. The generator may be started and final adjustments may be performed on the regulator.

Making Settings Changes

The following paragraphs describe how the HMI is used to make setting changes.

Front Panel Operation

The LEDs indicate control mode and status conditions and are also used when adjusting settings at the front panel. Repeatedly pressing the “SELECT” button steps through the various adjustments, starting with the “Coarse Voltage” adjustment and progressing through to the “Fine Voltage” adjustment. The next press of the “SELECT” button exits the adjustment mode.

When in the adjustment mode, only the adjustment LEDs will be lit. All mode status LEDs will be turned off. Adjustment LEDs are of two types. The first type is the LED that indicates the function being adjusted. This LED blinks slowly (approximately once per second). The second type is the LED that indicates the level of adjustment. This LED is on steady. The level of adjustment is changed by pressing the “UP” or “DOWN” button. When an adjustment level LED (on steady) overlaps the function LED (slow blinking), the LED will remain in the slow blinking mode. If no button is pressed for a period of one minute, the regulator saves the settings and exits the adjustment mode. If regulator power is interrupted before the automatic save feature is commanded, that level of adjustment will be lost.

When the regulator is not in the adjustment mode and either the “UP” or “DOWN” button is pressed, the regulator enters the “Fine Voltage” adjustment mode and changes the generator fine voltage set point by 0.1V. Successive presses of the “UP” or “DOWN” button shall continue to adjust the fine voltage setting. Pressing the “SELECT” button causes the regulator to exit the adjustment mode. Mode status LEDs blink approximately twice per second.

Table 2-3. BE2000E Front Panel Adjustment Indicator Descriptions

Indicator	Description
Fine Voltage LED #11	This LED blinks slowly when the "Fine Voltage" level is selected for adjustment via the front panel push-buttons.
Gain LED #10	This LED blinks slowly when the "Gain" adjustment is selected for fine tuning of loop gain via the front panel push-buttons.
Stability Range LED #9	This LED blinks slowly when selecting the desired "Stability Range" via the front panel push-buttons.
Droop LED #8	This LED blinks slowly when the "Droop" percentage level is selected for adjustment via the front panel push-buttons.
Under Frequency LED #7	This LED blinks slowly when the "Under Frequency" knee point is selected for adjustment via the front panel push-buttons.
VAR/PF Adjust LED #6	This LED blinks slowly when the level of the programmed mode (VAR or Power Factor) is selected for adjustment via the front panel push-buttons.
VAR/PF Select LED #5	This LED blinks slowly when selecting the programmed mode (VAR, Power Factor, or none(AVR)) via the front panel push-buttons. When in this adjustment mode, LED #1 is on solid for none (AVR), LED #2 is on solid for Power Factor mode, and LED #3 is on solid for VAR mode.
Manual Mode Adj. LED #4	This LED blinks slowly when the "Manual Mode" (field current) regulation set point is selected for adjustment via the front panel push-buttons.
Manual Mode On/Off LED #3	This LED blinks slowly when selecting or deselecting "Manual Mode" (field current regulation) as the active operating mode via the front panel push-buttons. When in this adjustment mode, LED #1 is on if Manual Mode is off, LED #2 is on if Manual Mode is on.

Indicator	Description
1 - 3 Phase Sensing LED #2	This LED blinks slowly when selecting single or three phase sensing via the front panel push-buttons. When in this adjustment mode, LED #1 is on if single phase sensing is selected, LED #3 is on if three phase sensing is selected.
Coarse Voltage LED #1	This LED blinks slowly when the "Coarse Voltage" level is selected for adjustment via the front panel push-buttons.

Setting Level Indication

Indication of a setting level is provided by the 12 front panel LED indicators. The upper limit of a setting range is represented by the top LED which is labeled GEN/LAG and MAX. The lower limit of a setting range is represented by the bottom LED which is labeled MIN and ABSORB/LEAD. The setting range for each LED is summarized in Tables 4 through 15. LEDs in the tables are numbered from 1 to 12 with 1 being the lowermost LED (labeled MIN/ABSORB/LEAD) and 12 being the uppermost LED (labeled GEN/LAG/MAX).

Table 2-4. Coarse Voltage Adjust Setting Ranges

Coarse Voltage – LED #1 Blinking Slowly				
Maximum Adjustment Range Increment: 6 Vac				
LED	Increase		Decrease	
	Minimum Value	Maximum Value	Minimum Value	Maximum Value
12	563	600.00	558	600
11	521	557	516	552
10	479	515	474	510
9	437	473	432	468
8	395	431	390	426
7	353	389	348	384
6	311	347	306	342
5	269	305	264	300
4	227	263	222	258
3	185	221	180	216
2	143	179	138	174
1	95	137	95	132

Table 2-5. Sensing Mode (Single-phase/Three-phase) Select

Single-phase/Three-phase select – LED #2 Blinking Slowly	
LED	MODE
12	N/A
11	N/A
10	N/A
9	N/A
8	N/A
7	N/A
6	N/A
5	N/A

Single-phase/Three-phase select – LED #2 Blinking Slowly	
LED	MODE
4	N/A
3	Three-phase
2	N/A
1	Single-phase

Table 2-6. Manual Mode (On/Off) Select

Manual Mode On/Off – LED #3 Blinking Slowly	
LED	MODE
12	N/A
11	N/A
10	N/A
9	N/A
8	N/A
7	N/A
6	N/A
5	N/A
4	N/A
3	N/A
2	ON
1	OFF

Table 2-7. Manual Mode (If – Limit) Adjustment Ranges

Manual Mode Adjust – LED #4 Blinking Slowly		
Adjustment Range: 0 to 3 Adc		
Increment: 0.01 Adc		
LED	Minimum Value	Maximum Value
12	2.75	3
11	2.50	2.74
10	2.25	2.49
9	2.00	2.24
8	1.75	1.99
7	1.50	1.74
6	1.25	1.49
5	1.00	1.24
4	0.75	0.99
3	0.50	0.74
2	0.25	0.49
1	0	0.24

Table 2-8. On-Line Operating Mode (AVR (OFF)/VAR/PF) Select

AVR (OFF) / VAR / PF Select – LED #5 Blinking Slowly	
LED	MODE
12	N/A
11	N/A
10	N/A
9	N/A
8	N/A
7	N/A
6	N/A
5	N/A
4	N/A
3	Var
2	PF
1	AVR

Table 2-9. VAR Control Adjustment Ranges

VAR Control Adjust – LED #6 Blinking Slowly		
Maximum Adjustment Range: –100% (absorb) to +100% (generate)		
Increment: 1.0%		
LED	Minimum Value *	Maximum Value *
12	84	100
11	67	83
10	51	66
9	34	50
8	17	33
7	1	16
6	-16	0
5	-33	-17
4	-49	-34
3	-66	-50
2	-83	-67
1	-100	-84

* Minimum and maximum values may differ from the Table 2-9 values if the value has been changed in BESTCOMS™-BE2000E software. BESTCOMS-BE2000E has 0.5 percent resolution compared to the 1.0 percent resolution of the HMI.

Table 2-10. Power Factor Control Adjustment Ranges

Power Factor Control Adjust – LED #6 Blinking Slowly Maximum Adjustment Range: +0.6 (lag) to –0.6 (lead) Increment: 0.01		
LED	Minimum Value †	Maximum Value †
12	0.66	0.60
11	0.73	0.67
10	0.80	0.74
9	0.86	0.81
8	0.93	0.87
7	1.0	0.94
6	-0.94	-0.99
5	-0.87	-0.93
4	-0.80	-0.86
3	-0.74	-0.79
2	-0.67	-0.73
1	-0.60	-0.66

† Minimum and maximum values may differ from the Table 2-10 values if the value has been changed in BESTCOMS-BE2000E software.
BESTCOMS-BE2000E has 0.001 resolution compared to the 0.01 resolution of the HMI.

Table 2-11. Underfrequency Adjustment Ranges

Underfrequency Adjust – LED #7 Blinking Slowly Maximum Adjustment Range: 40 to 65 Hz Increment: 0.1 Hz		
LED	Minimum Value	Maximum Value
12	63.0	65.0
11	60.9	62.9
10	58.8	60.8
9	56.7	58.7
8	54.6	56.6
7	52.5	54.5
6	50.5	52.4
5	48.4	50.4
4	46.3	48.3
3	44.2	46.2
2	42.1	44.1
1	40.0	42.0

Table 2-12. Droop Adjustment Ranges

Droop Adjust – LED #8 Blinking Slowly Adjustment Range: 0 to 10% Increment: 0.25%		
LED	Minimum Value *	Maximum Value *
12	9.25	10.00
11	8.5	9.00
10	7.75	8.25
9	6.75	7.50
8	6.00	6.50
7	5.25	5.75
6	4.25	5.00
5	3.5	4.00
4	2.75	3.25
3	1.75	2.5
2	1	1.5
1	0	0.75

* Minimum and maximum values may differ from the Table 2-12 values if the value has been changed in BESTCOMS-BE2000E software.
BESTCOMS-BE2000E has 0.01% resolution compared to the 0.25 percent resolution of the HMI.

Table 2-13. Stability Range Selection Settings

Stability Range Select – LED #9 Blinking Slowly Adjustment Range per LED: 1		
Frame/Poles	LED	Range Selected
	12	N/A
	11	N/A
	10	N/A
	9	N/A
Programmable	8	21
1,000/6	7	7
740/6	6	6
1,000/4	5	5
740/4	4	4
570/4	3	3
430/4	2	2
360/4	1	1

Table 2-14. Gain Adjustment Ranges

Gain Adjust – LED #10 Blinking Slowly				
Maximum Adjustment Range: 0.5 to 4.5 kg for AVR and 0 to 100 kg for FCR				
When the unit is operating in AVR, PF, and var modes, gain adjustments are made to AVR kg. When in FCR mode, gain adjustments are made to FCR kg. Front Panel increments: AVR kg = 0.01 FCR kg = 0.1				
LED	Minimum Value *		Maximum Value *	
	AVR	FCR	AVR	FCR †
12	4.17	11.1	4.50	12
11	3.84	10.1	4.16	11
10	3.50	9.1	3.83	10
9	3.17	8.1	3.49	9
8	2.84	7.1	3.16	8
7	2.50	6.1	2.83	7
6	2.17	5.1	2.49	6
5	1.84	4.1	2.16	5
4	1.50	3.1	1.83	4
3	1.17	2.1	1.49	3
2	0.85	1.1	1.16	2
1	0.5	0	0.84	1

* Minimum and maximum values may differ from the Table 2-14 values if the gain value has been changed in BE2000E software.

† BESTCOMS-BE2000E software allows a maximum FCR kg setting of 1,000 kg. A kg setting of 12 or more entered in BESTCOMS-BE2000E will be reduced to 12 with the first push of the HMI “DOWN” pushbutton when adjusting FCR kg via the front panel.

Table 2-15. Fine Voltage Adjust Setting Ranges

Fine Voltage Adjust – LED #11 Blinking Slowly
Maximum Adjustment Range: –15% to +15% Increment: 0.1V
The adjustment range for Fine Voltage Adjust is based on the fine voltage adjustment band setting. The default adjustment range is –10% to +10%. See the <i>BESTCOMS Software</i> chapter for information about the Fine Voltage Adjustment Band Setting.

Communication Port

A communication port is located on the rear panel and consists of a female RS-232 (DB-9) connector. The communication port serves as an interface for programming (setup) of the BE2000E. Figure 2-2 illustrates the location of the communication port.

Programming requires a standard 9-pin serial communication cable connected between the BE2000E and an IBM-compatible PC or handheld computer operating with BESTCOMS-BE2000E software. BESTCOMS-BE2000E operates with systems using Windows® XP 32-bit SP2/SP3, Windows Vista 32-bit (all editions), Windows 7 32-bit (all editions), and Windows 7 64-bit (all editions). BESTCOMS-BE2000E is supplied with the BE2000E. A detailed description of BESTCOMS-BE2000E is provided in the *BESTCOMS Software* chapter.

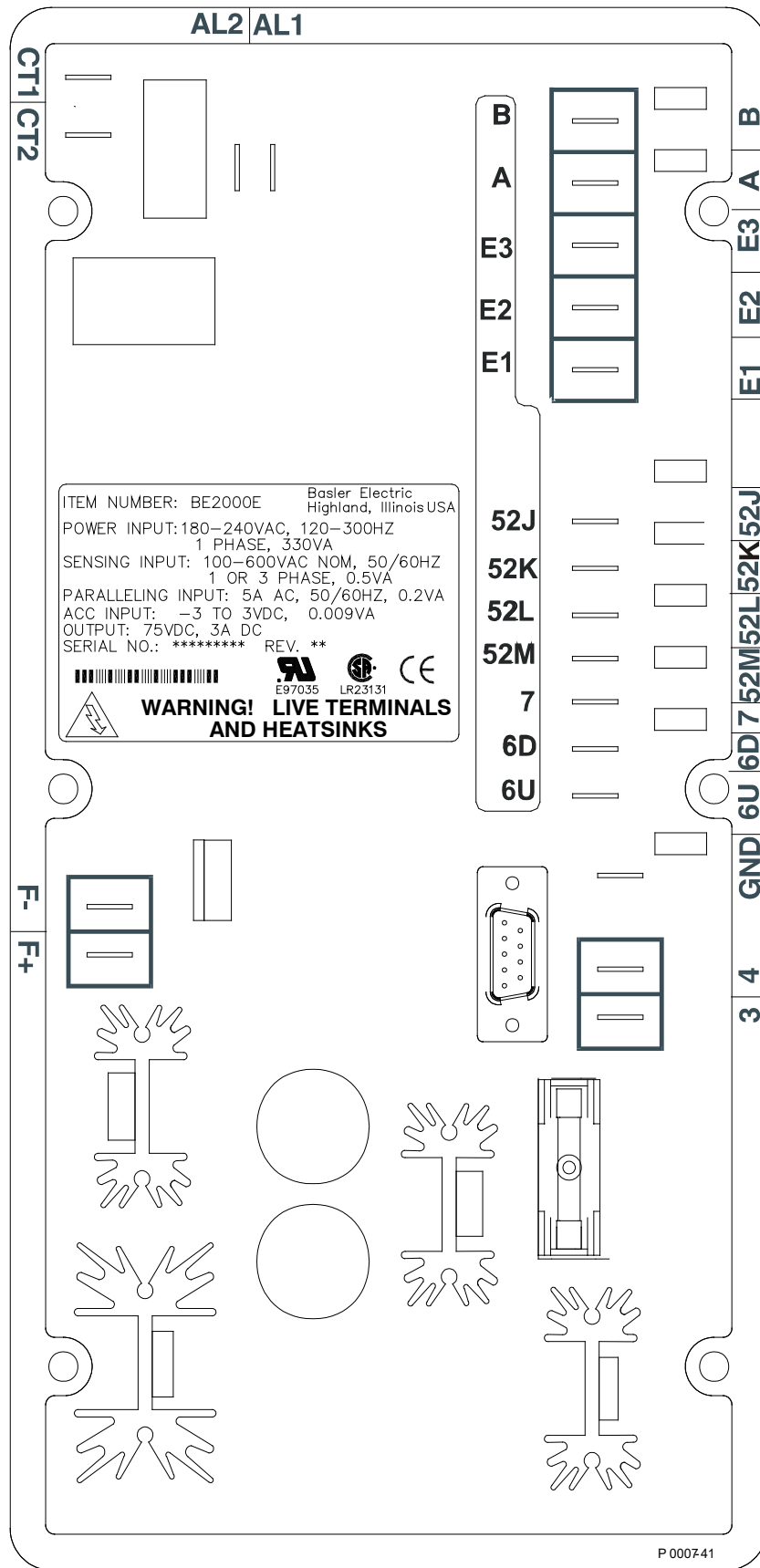

Figure 2-2. Location of Communication Port.

3 • Functional Description

This chapter describes how the BE2000E functions and explains its operating features. To ease understanding, BE2000E functions are illustrated in the block diagram of Figure 3-1. A detailed description of each function block is provided in the paragraphs under the heading of *BE2000E Function Blocks*.

BE2000E operating features include four operating modes, four protective functions, startup provisions, reactive droop compensation, underfrequency compensation, and an auxiliary analog input. A detailed description of each operating feature is provided in the paragraphs under the heading of *BE2000E Operating Features*.

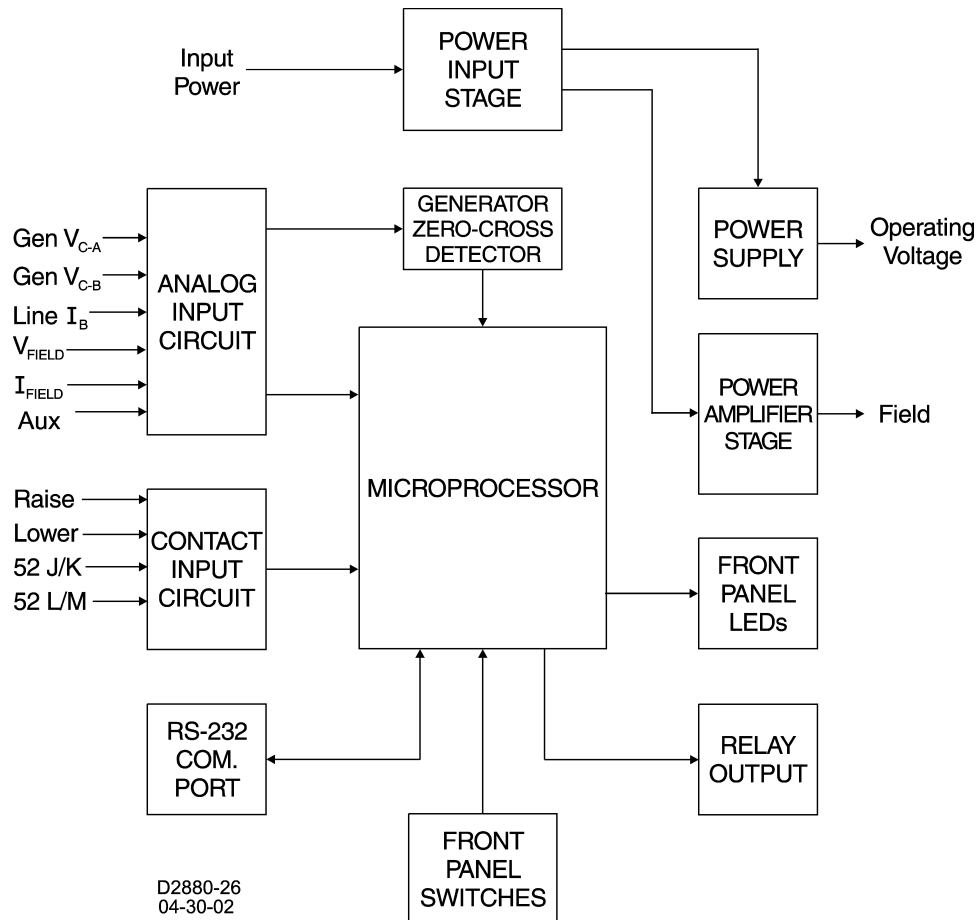

Figure 3-1. Simplified Function Block Diagram

BE2000E Function Blocks

The following paragraphs describe each of the function blocks illustrated in Figure 3. The function of each block is explained along with the operation of all function block inputs and outputs.

Analog Inputs

Six analog voltage and current inputs may be sensed and brought to the BE2000E input.

Generator Voltage

Generator voltage is monitored at terminals E1 (A-phase), E2 (B-phase), and E3 (C-phase). Nominal voltages of up to 600Vac may be sensed at these terminals. Voltage applied to these inputs is scaled and conditioned before being applied to the input of the ADC. The voltage signal from phase C and A (V_{C-A}) of

the generator is used by the ADC to calculate the rms value of generator voltage across phases C and A. Likewise, the voltage signal from phase C and B (V_{C-B}) of the generator is used by the ADC to calculate the rms value of generator voltage across phases C and B. The rms value of generator phase B to phase A voltage (V_{B-A}) is calculated by the microprocessor from the phase C to phase A signal (V_{C-A}) and the phase C to phase B (V_{C-B}) signal.

Additionally, the generator phase C to phase A (V_{C-A}) signal is applied to a filtered zero cross detector circuit. This signal is applied to the microprocessor and is used to calculate generator frequency.

Phase B Line Current

The phase B line current (I_B) signal is developed through a customer supplied current transformer (CT) and monitored through terminals CT1 and CT2. Current up to 5 amperes rms may be monitored at these terminals. The current monitored at these terminals is scaled and conditioned by an internal current transformer and active circuitry for use by the ADC. The signal applied to the ADC is used to calculate the rms value of phase B line current.

Additionally, the phase angle between phase B line current and phase C to phase A generator voltage is calculated for use during Droop and Var/Power Factor operation.

Field Voltage (V_{FIELD})

Voltage across the regulator field output terminals, F+ and F-, is monitored, scaled, and conditioned before being applied to the ADC. This signal is used to calculate the dc value of field voltage for use in system protection.

Field Current (I_{FIELD})

Current through the main power output switch is converted to a proportional voltage level. This voltage signal is scaled and conditioned before being applied to the input of the ADC. The result is used to calculate the dc value of field current for use in the Manual mode of operation as well as protection of the system.

Analog (Auxiliary) Input

Caution

If the dc voltage is removed from the Analog (Auxiliary) Input, the operating setpoint will return to the original value.

This input allows adjustment of the BE2000E regulation setpoint by the application of a positive or negative dc voltage across terminals A and B. Voltage up to +3 Vdc may be applied at this input. The circuit induces a 1,000-ohm burden on the dc source. The application of a +3 Vdc signal corresponds to a +30 percent change in setpoint.

Contact Input Circuits

Four contact input circuits powered from an internal 13 Vdc supply provide input control from user-supplied contacts.

Raise

Closing a contact across terminals 6U and 7 causes the active operating setpoint to increase. This function is active as long as the contact is closed.

Lower

Closing a contact across terminals 6D and 7 causes the active operating setpoint to decrease. This function is active as long as the contact is closed.

Var/Power Factor Control (52J/K)

Closing a contact across terminals 52J and 52K disables var/power factor control. An open contact enables the BE2000E to control the generator reactive power in either the var or the power factor mode. For more information, refer to the Parallel Generator Compensation (52L/M) contact input.

Parallel Generator Compensation (52L/M)

Closing a contact across terminals 52L and 52M disables parallel operation. An open contact enables parallel operation and the BE2000E operates in reactive droop compensation mode.

The 52J/K input has priority. Therefore, if the 52J/K and the 52L/M inputs are both open, the system operates in var/power factor mode.

Communication Port

The communication port provides the interface for user programming (setup) of the BE2000E. Connection is made to the female RS-232 (DB-9) connector with a user-supplied, standard 9-pin cable. The communication port is optically isolated and is powered from a transformer-isolated supply.

Microprocessor

The microprocessor is the heart of the BE2000E and performs measurement, computation, control, and communication functions by the use of its embedded programming and the nonvolatile settings stored in its memory.

Power Input Stage

Input power is applied to terminals 3 and 4 from the PMG. It is rectified and filtered before being applied to the power amplifier and the power supply. Input power is single-phase in the range of 180 to 240 Vac at a frequency of 120 to 300 hertz.

Power Supply

The internal switch-mode power supply receives power from the power input stage and supplies power at the required dc voltage levels to the internal circuitry of the BE2000E.

Power Amplifier Stage

The power amplifier receives power from the power input stage and supplies a controlled amount of power to the exciter field via terminals F+ and F-. The amount of power supplied to the exciter field is based on gating pulses received from the microprocessor. The power amplifier uses a solid state power switch to provide the required power to the exciter field. Power amplifier output to the field is rated up to 75 Vdc at 3 Adc continuous and 150 Vdc at 7.5 Adc for 10 seconds.

Front Panel Indicators

Twelve front panel LED indicators light to indicate various operating modes, protective functions, and adjustments. The *Human-Machine Interface* chapter provides more information about the front panel indicators.

Front Panel Switches

Changes to settings can be made at the front panel using the three pushbutton switches. These push-buttons are labeled Select, Up, and Down. The *Human-Machine Interface* chapter provides more information about the front panel switches.

Relay Output

A common alarm output contact is provided through terminals AL1 and AL2. This normally open, form A contact annunciates alarm or generator trip conditions and closes in the event of a protective shutdown or transfer. The relay output is non-latching.

BE2000E Operating Features

The following paragraphs describe the characteristics of each BE2000E operating feature.

Operating Modes

The BE2000E provides up to four modes of operation selectable through Windows® communication software. Automatic voltage regulation mode, Manual mode, Var mode, and Power Factor mode are standard features.

Automatic Voltage Regulation Mode

In Automatic Voltage Regulation (AVR) mode, the BE2000E regulates rms generator output voltage. This is accomplished by sensing generator output voltage and adjusting dc output excitation current to maintain voltage at the regulation setpoint. The regulation setpoint is adjusted by the Raise and Lower contact inputs, front panel switches, or through Windows communication software. The regulation point may also be modified by the Droop function or the Underfrequency function under certain conditions.

Manual Mode

In Manual mode, also known as Field Current Regulation (FCR) mode, the BE2000E maintains dc excitation current at a set level. The current-level setpoint is adjustable from 0 to 3 Adc by the Raise and Lower contact inputs, front panel switches, or through Windows communication software.

Warning!

The Manual mode excitation level must be evaluated prior to enabling this feature. If the level of excitation current is inappropriate for the generator, severe damage to the generator may occur.

Var Control Mode

In Var Control mode, the BE2000E maintains generator vars (volt-amperes, reactive) at a set level when paralleling with an infinite bus. The BE2000E calculates generator vars using the sensed generator output voltage and current quantities and then adjusts the dc excitation current to maintain vars at the setpoint. Var control is enabled and disabled through the front panel switches or Windows communication software. When the software is turned on, var control is enabled or disabled through the var/Power Factor Control (52J/K) contact input circuit. The var setpoint is adjustable from 100 percent absorb to 100 percent generate through the Raise and Lower contact inputs, front panel switches, or through Windows software.

Power Factor Control Mode

In Power Factor Control mode, the BE2000E maintains generator power factor at a set level when paralleling with an infinite bus. The BE2000E calculates generator power factor using the sensed generator output voltage and current quantities and then adjusts the dc excitation current to maintain power factor at the setpoint. Power factor control is enabled or disabled through the front panel switches or Windows software. When the software is turned on, it is enabled or disabled through the var/Power Factor Control (52J/K) contact input circuit. The power factor setpoint is adjustable between 0.6 lag and 0.6 lead through the Raise and Lower contact inputs, front panel switches or through Windows communication software.

Reactive Droop Compensation

The BE2000E provides a reactive droop compensation feature to assist in the sharing of reactive load during parallel generator operation. When this feature is enabled, the BE2000E calculates the reactive portion of the generator load using the sensed generator output voltage and current quantities and then modifies the voltage regulation setpoint accordingly. A unity power factor generator load results in almost no change in generator output voltage. A lagging power factor generator load (inductive) results in a

reduction of generator output voltage. A leading power factor generator load (capacitive) results in an increase of generator output voltage. Droop is adjustable up to 10 percent with rated, nominal B-phase line current (5 amperes applied through terminals CT1 and CT2) and 0.8 power factor. The droop feature is enabled and disabled through the Parallel Generator Compensation contact input circuit (terminals 52L and 52M). The 52J/K input must also be closed to disable droop.

Underfrequency

Generator Underfrequency

When generator frequency drops below the selected knee frequency setpoint, the voltage setpoint is automatically adjusted by the BE2000E so that generator voltage follows the selected PU (per unit) V/Hz curve. When operating on the selected PU V/Hz curve, the Underfrequency Active indicator flashes on the front panel and in BESTCOMS™-BE2000E software. The knee frequency is adjustable from 40 to 65 hertz and the PU V/Hz curve may be set to a slope from 1 to 3 in increments of 0.01 through the Windows communication software. The default is 59 Hz and a slope of 1.

Engine Unloading

The engine unloading feature modifies the underfrequency curve. This feature becomes active when the generator frequency decreases a programmable amount (Unloading Activation - Frequency) below the knee frequency setpoint, and when the speed change rate is greater than the Unloading Activation - Rate. The amount of droop while engine unloading is active is adjusted by the Unloading Droop - Percentage (%) setting. The amount of time engine unloading is active is set by Unloading Droop - Time (sec.).

Engine unloading adjustments are made through BESTCOMS-BE2000E software.

Unloading Activation - Frequency (Hz) is entered as a value below the underfrequency corner where the engine unloading feature may be activated. A frequency value of 0.9 to 9.0 Hz can be entered in 0.1 Hz increments. The default value is 0.9 Hz.

Unloading Activation - Rate (Hz/25 ms) of 0 to 25.5 Hz per 25 ms can be entered in 0.1 Hz per 25 ms increments. The engine unloading feature is activated when the frequency rate of change exceeds the setting of this field. The default value is 0.1.

Unloading Droop - Percentage (%) field defines the percent drop in generator output voltage for each 1.5 percent decrease in generator frequency when operating in the Engine Unloading mode. The Unloading Droop Percentage is adjustable from 1 to 20 percent in 1 percent steps. The default value is 10 percent.

Unloading Droop - Time (sec) value defines the length of time that the Engine Unloading mode may be active before control is passed to the normal Underfrequency mode of operation. Droop time is adjustable from 1 to 5 seconds in 1 second increments. The default value is 1 second.

Protection

The BE2000E has the six protective functions listed below:

- Overexcitation shutdown
- Generator overvoltage shutdown
- BE2000E overtemperature shutdown
- Loss of generator sensing shutdown
- Overexcitation limiting
- Crowbar shutdown

Each function, except Crowbar Shutdown, has a corresponding front panel indicator that lights when the function is active. An active function (except Crowbar Shutdown) is also annunciated through the Windows communication software.

Overexcitation Shutdown (Field Voltage)

This function is enabled or disabled through BESTCOMS-BE2000E software. When enabled, if field voltage exceeds the setpoint (80 Vdc default), the Overexcitation Shutdown indicator flashes on the front panel and in the Windows communication software, the relay output closes after 15 seconds and the

BE2000E shuts down. When the BE2000E is powered up following an over-excitation shutdown, the Overexcitation Shutdown indicator will flash for 5 seconds.

Generator Overvoltage Shutdown

The BE2000E monitors the sensed generator output voltage. If it exceeds the overvoltage setpoint (a percent of nominal) for 0.75 seconds, the Generator Overvoltage indicator flashes on the front panel LED and in the Windows communication software, the relay output closes and the BE2000E shuts down. When the BE2000E is powered up following a generator overvoltage shutdown, the Generator Overvoltage indicator will flash for 5 seconds. The default setpoint is 120 percent of nominal.

BE2000E Overtemperature Shutdown

A temperature sensor within the BE2000E continually monitors the temperature of the device. If the temperature exceeds 70° C (158° F), the BE2000E Overtemperature indicator flashes on the front panel and in the Windows communication software, the relay output closes and the BE2000E shuts down.

Loss of Generator Sensing Shutdown

The BE2000E monitors the sensed generator output voltage and takes protective action if a loss of sensing voltage is detected. For single-phase sensing, a sensed voltage of less than 50 percent of nominal is interpreted as a loss of sensing. For three-phase sensing, the total loss of a sensed phase or an imbalance between phases of more than 20 percent nominal is interpreted as a loss of sensing. When sensing input continuity is not lost, an adjustable time delay of 0 to 25 seconds is present when a loss of sensing condition is detected. If sensing input continuity is lost, the time delay is disabled.

If a loss of sensing occurs, the Loss of Generator Sensing indicator flashes on the front panel and in the Windows communication software, the relay output closes, and the BE2000E shuts down. When the BE2000E is powered up following a loss of generator sensing shutdown, the Loss of Sensing indication will flash for 5 seconds.

This function is disabled when a generator short circuit condition is detected or when sensed frequency drops below 12 Hz. A generator short-circuit is determined when the phase B CT current exceeds 3PU (>15 Aac sensing current). Loss of sensing is not active during soft start time.

Overexcitation Limiting (Field Current)

The BE2000E has a field current limit that is factory preset at 6.5 amperes. The limit is adjustable from 0 to 7.5 amperes with an adjustable time delay that has a range of 0 to 10 seconds. Both settings are made through the Windows communication software. When the overexcitation limit is exceeded, the Overexcitation Limiting indicator flashes on the front panel and in the Windows communication software. When the adjustable time delay expires, the relay output closes and the BE2000E shuts down. When the BE2000E is powered up following overexcitation limiting, the Overexcitation Limiting indicator will flash for 5 seconds.

Crowbar Shutdown

The Crowbar Shutdown Circuit protects the generator rotor from overcurrent damage resulting from a shorted BE2000E power switch. During operation, if the field voltage exceeds the setpoint and the power stage receives no gating pulses for 1.5 seconds, the Crowbar Circuit activates and places a short-circuit across the BE2000E input power terminals. This protects the generator by blowing the input power fuse and removing operating power from the device.

Generator Soft Start

The BE2000E incorporates an adjustable soft start feature that controls the time for generator voltage to ramp to the regulation setpoint. The ramp rate is adjustable from 1 to 120 seconds in 1 second increments through the Windows communication software. The underfrequency feature is also active during soft start and takes priority in control of the generator voltage. The default setting is 7 seconds.

4 • Installation

The BE2000E is delivered in a sturdy carton to prevent shipping damage. Upon receipt, check the part number against the requisition and packaging list for agreement. Inspect for damage, and if there is evidence of such, immediately file a claim with the carrier and notify your sales representative or a sales representative at Basler Electric.

If the unit is not installed immediately, store it in the original shipping package in a moisture- and dust-free environment.

Mounting

The BE2000E is normally located in the generator conduit box. It is designed for behind the panel mounting and requires a cutout for front panel viewing and access. Mounting hardware consists of six customer supplied, #12 thread-forming screws that pass through mounting holes in the conduit box and thread into the plastic shell of the BE2000E. The unit must be mounted where the ambient temperature does not exceed the allowable environmental conditions called out in the *General Information* chapter. BE2000E package dimensions are shown in Figure 4-1. Cutout and drilling dimensions are shown in Figure 4-2.

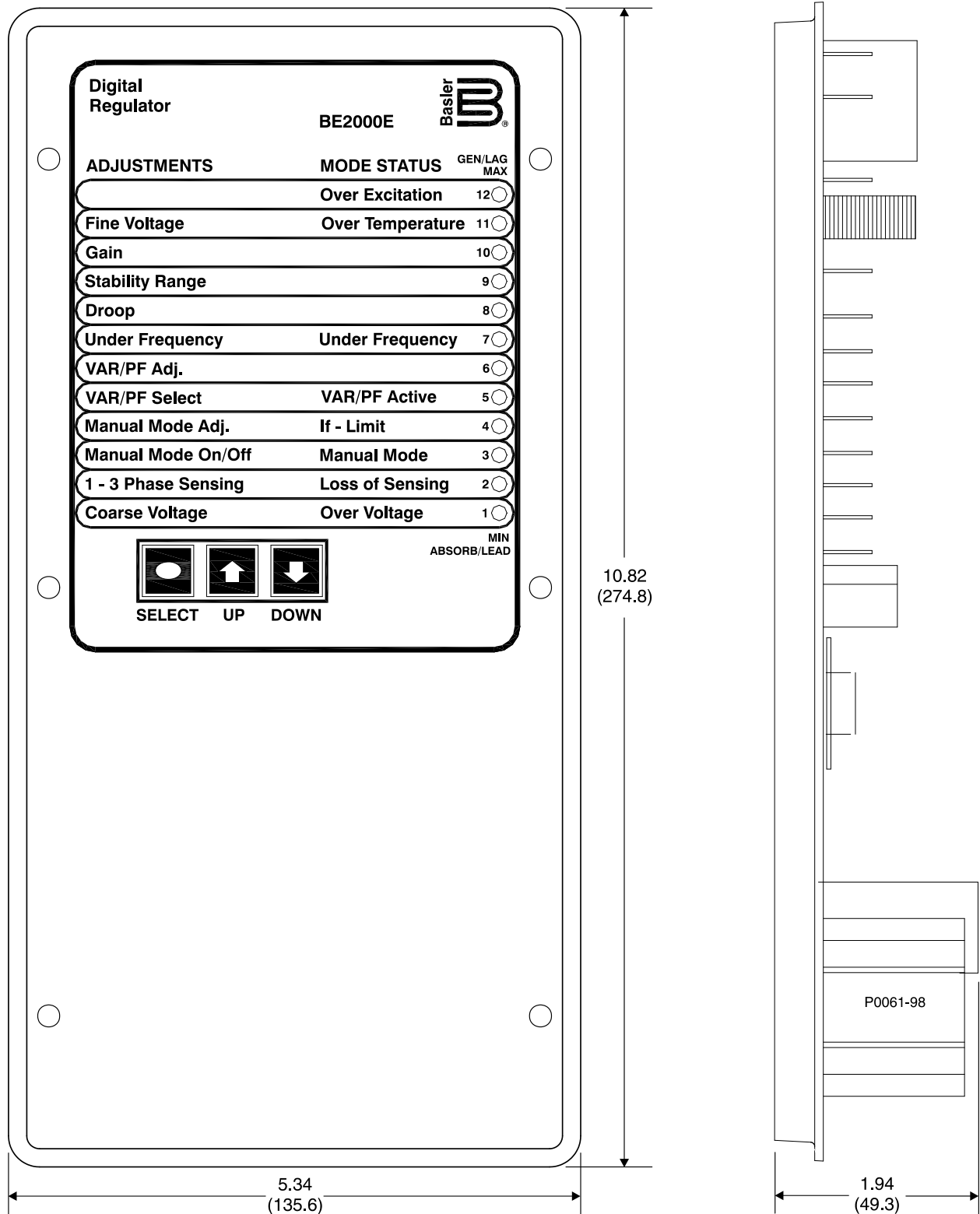

Figure 4-1. BE2000E Dimensions

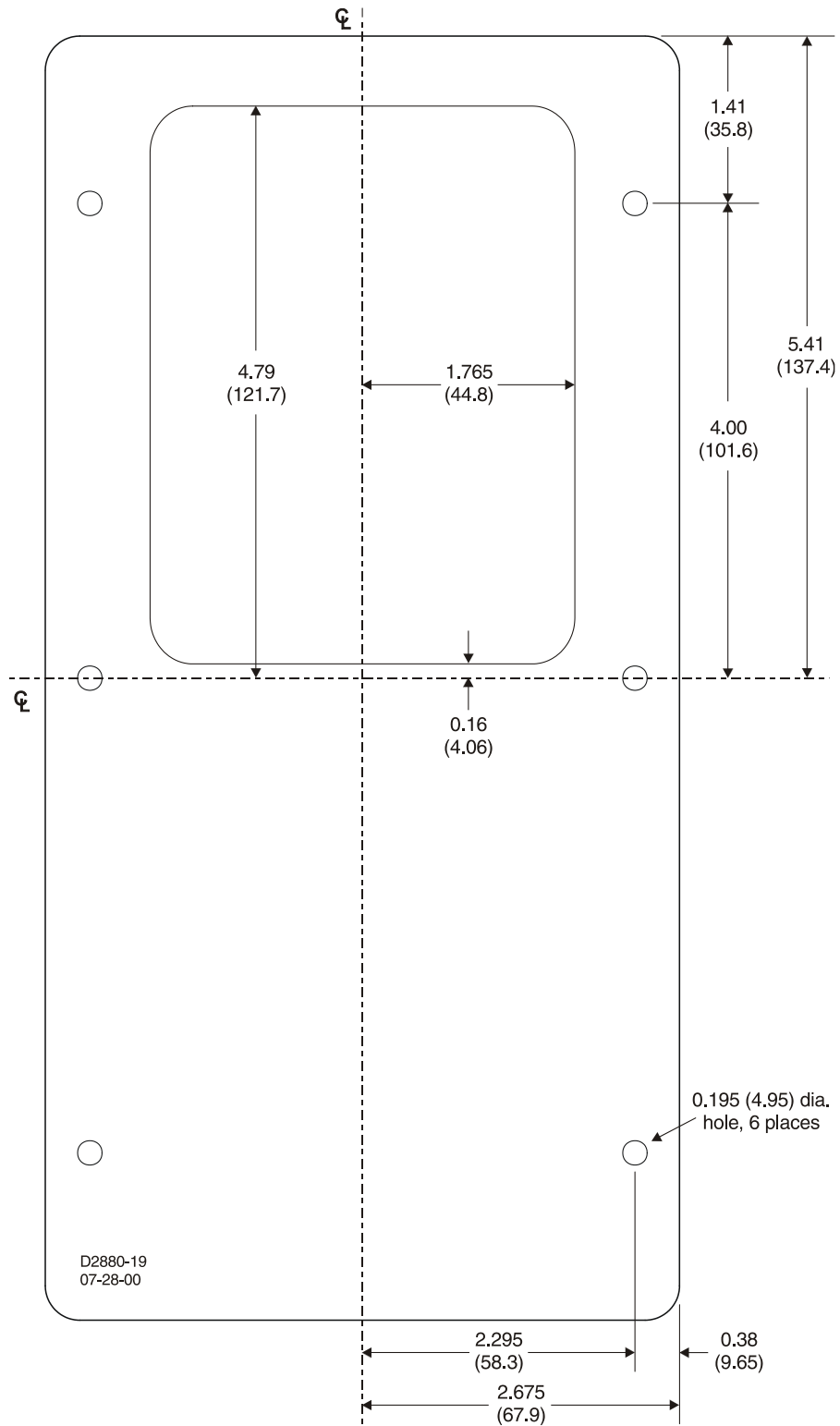

Figure 4-2. Cutout and Drilling Dimensions

Connections

BE2000E connections are dependent on the application. Incorrect wiring may damage the unit.

Note
Be sure that the BE2000E is hard-wired to earth ground with no smaller than 12 AWG copper wire attached to the ground terminal on the rear of the unit case. When the unit is configured in a system with other devices, it is recommended to use a separate lead to the ground bus from each device.

BE2000E Terminations

BE2000E units have two types of interface terminals (Figure 4-3). One type is quarter-inch, quick-connect terminals and the other is a nine-pin DB9 connector. All terminals are located on the rear of the unit. The quarter-inch, quick-connect terminal labels are located on the rear of the case. Wires performing common functions, such as voltage sensing leads, should be grouped together. The nine-pin DB-9 type connector is used for temporary interface with both IBM compatible PCs and hand-held computers.

Figure 4-3 shows the terminal connections located on the rear panel of the BE2000E. Except as noted above, connections should be made with minimum wire size of 14 AWG.

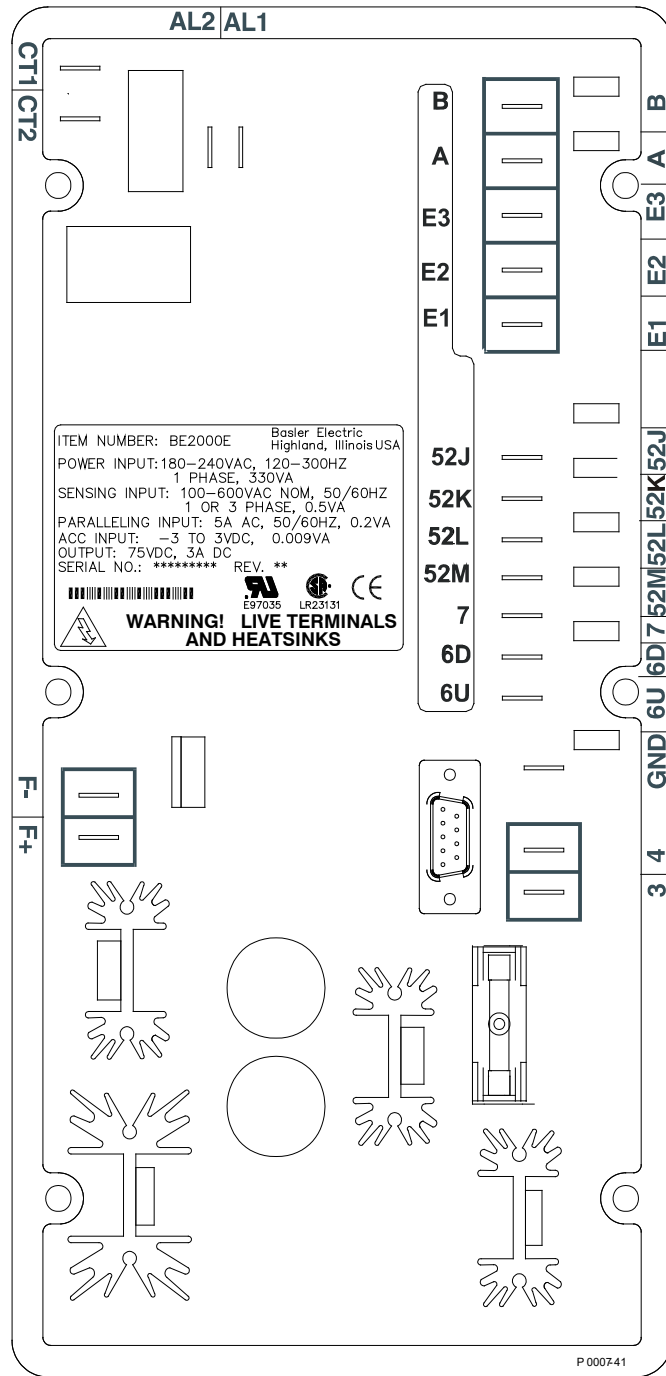

Figure 4-3. BE2000E Rear Panel Terminals

Generator Voltage Sensing Inputs

The generator voltage sensing terminals are labeled E1, E2, and E3. A single-phase sensing connection is obtained by connecting the C-phase sensing input to terminals E2 and E3. Table 4-1 lists the terminal assignments for three-phase and single-phase generator voltage sensing.

Table 4-1. Generator Voltage Sensing Terminals

Sensing	Generator Phase	Terminal
3-Phase	A	E1
	B	E2
	C	E3
1-Phase	A	E1
	C	E2, E3

Phase B Line Current Sensing Input

Generator line current is stepped down through a user-supplied current transformer (CT). Secondary current from that transformer is applied to terminals labeled CT1 and CT2.

Raise and Lower Contact Inputs

Remote setpoint adjustment may be accomplished by connecting a single-pole, double-throw (SPDT), spring return, center-off switch to the terminals labeled 6U, 7, and 6D. To connect this switch, the center pole, or common terminal, must be connected to terminal 7. The other two terminals are connected to terminals 6U and 6D. This remote adjust switch may be mounted up to 150 feet (45 meters) away from the BE2000E when using twisted, shielded cable.

Var/Power Factor Control Contact Input

A customer supplied enable/disable contact for this function connects to the terminals labeled 52J and 52K. This function is disabled by a closed contact.

Parallel Generator Compensation

A customer supplied enable/disable contact for this function connects to the terminals labeled 52L and 52M. This function is disabled by a closed contact.

Analog (Auxiliary) Adjust

Caution

If the dc voltage is removed from the Analog (Auxiliary) Input, the operating setpoint will return to the original value.

This input allows adjustment of the BE2000E regulation setpoint by the application of a positive or negative dc voltage across terminals A and B. Voltage up to +3 Vdc may be applied at this input. The circuit induces a 1,000-ohm burden on the dc source. The application of a +3 Vdc signal corresponds to a +30 percent change in setpoint.

Power Supply Inputs

Power input terminals are labeled 3 and 4.

Chassis Ground

The chassis ground terminal is labeled GND.

Power (Field) Output

The field output terminals for connection to the generator exciter field are labeled F+ and F-.

Relay Output

The common alarm relay output contact may be accessed at the terminals labeled AL1 and AL2. The relay output is normally open.

Communication Port

The RS-232 port on the rear panel uses a DB-9 female connector. Figure 4-4 illustrates the pin assignments of the communication port and Table 4-2 identifies the RS-232 connector pin functions. A standard communication cable terminated with a DB-9 male connector is used for PC or hand-held computer interface with the BE2000E as shown in Figure 4-5.

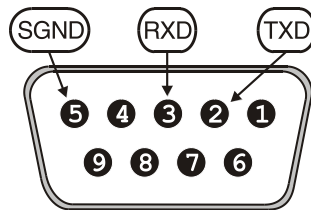

Figure 4-4. Communication Port Pin Assignments

Table 4-2. Communication Port Pin Functions

Pin	Function	Name	Direction
1	N/C	----	N/A
2	Transmit Data	TXD	From BE2000E
3	Receive Data	RXD	To BE2000E
4	N/C	----	N/A
5	Signal Ground	GND	N/A
6	N/C	----	N/A
7	N/C	----	N/A
8	N/C	----	N/A
9	N/C	----	N/A

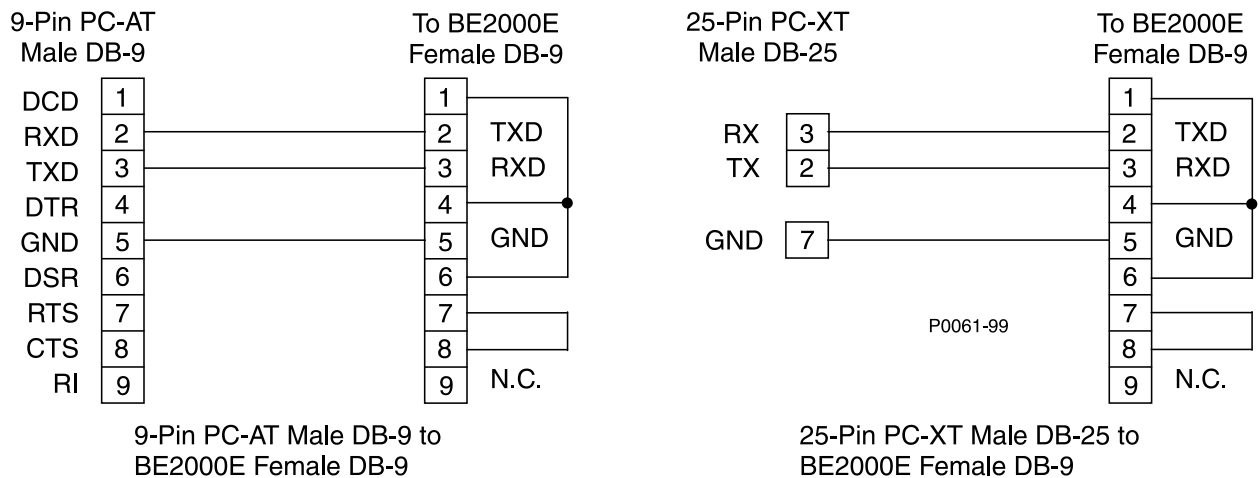

Figure 4-5. Personal Computer to BE2000E Connections

BE2000E Connections for Typical Applications

Figures 4-6 through 4-9 illustrate typical applications using the BE2000E. Figure 4-6 shows an application where the BE2000E is connected for three-phase voltage sensing. Figure 4-7 shows an application with single-phase voltage sensing while Figure 4-8 illustrates an application with a single-phase generator.

Figure 4-9 illustrates the connection of two BE2000E devices used in a Cross-Current (Reactive Differential) application. Note that the 0.1 ohm resistor shown may have to vary. When operating in parallel reactive differential mode (cross current), attention must be paid to the use of the burden resistor shown in Figure 4-9. The burden resistor should have a value approximately 10 times the cross current loop resistance for proper differential operation. The value of 0.1 ohm is a suggested value. The volt-ampere (VA) capacity of the paralleling current transformers should be considered after sizing the burden resistor.

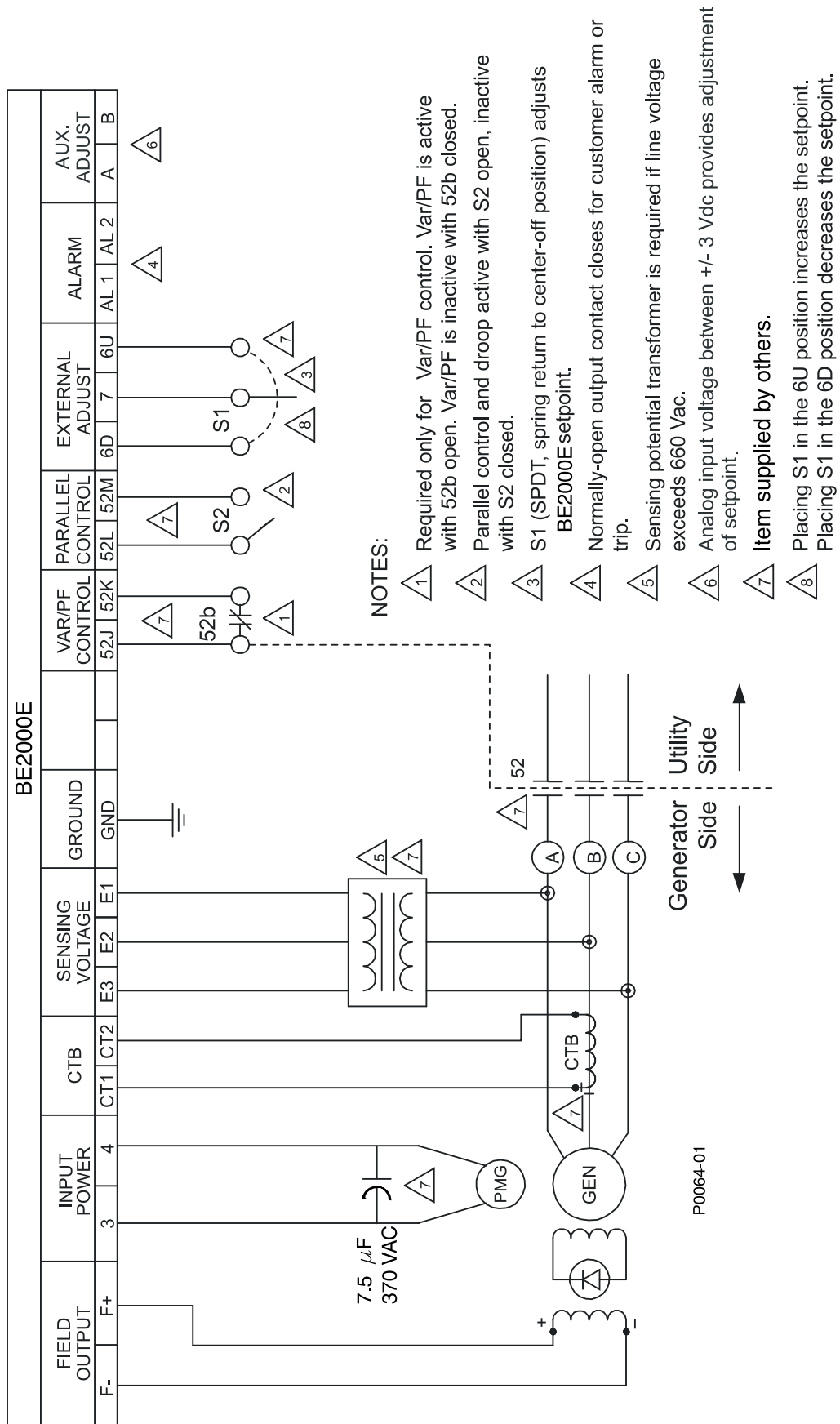

Figure 4-6. Typical Connections with ABC Rotation and Three-Phase Sensing

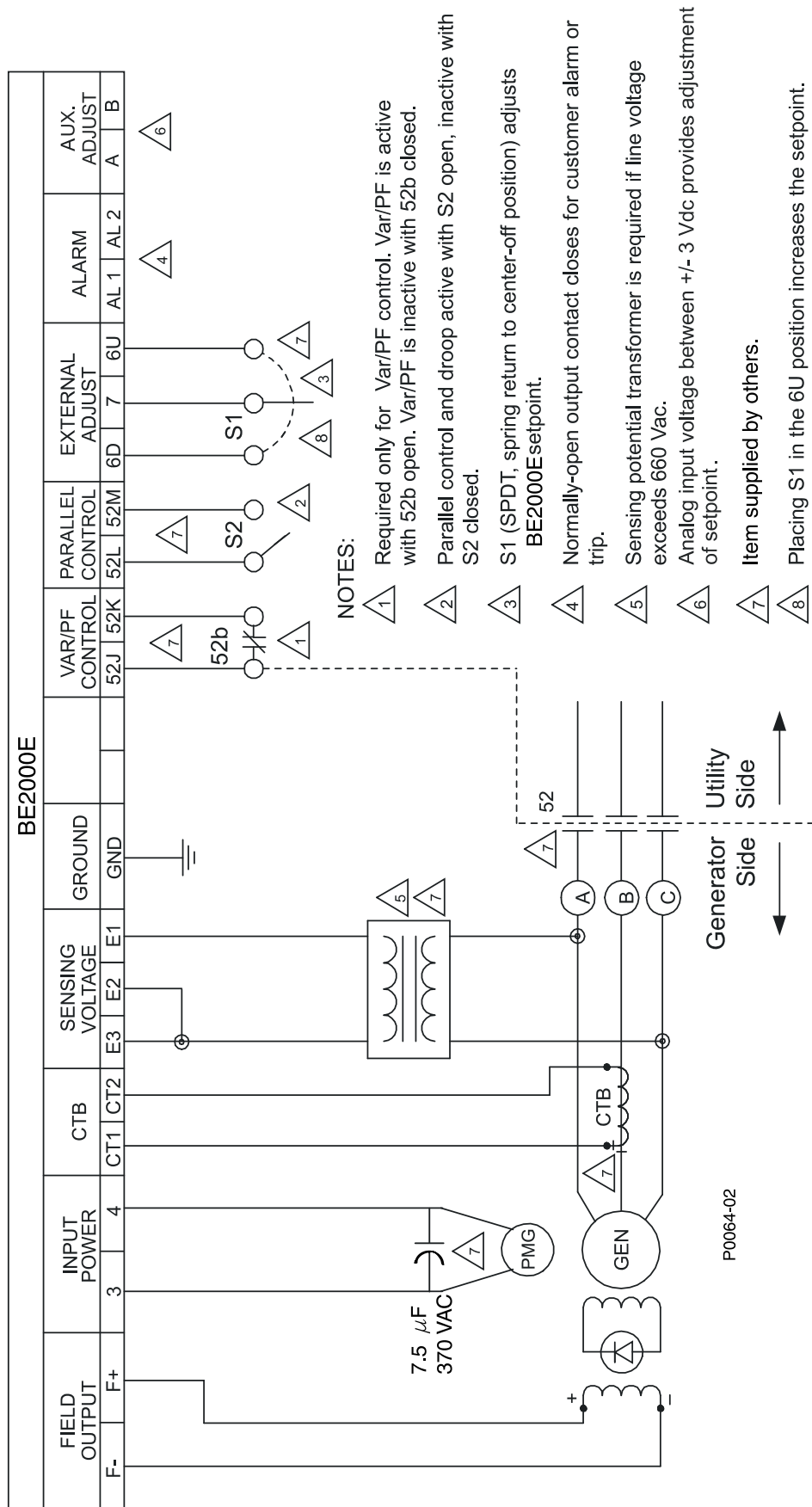

Figure 4-7. Typical Connections with ABC Rotation and Single-Phase Sensing

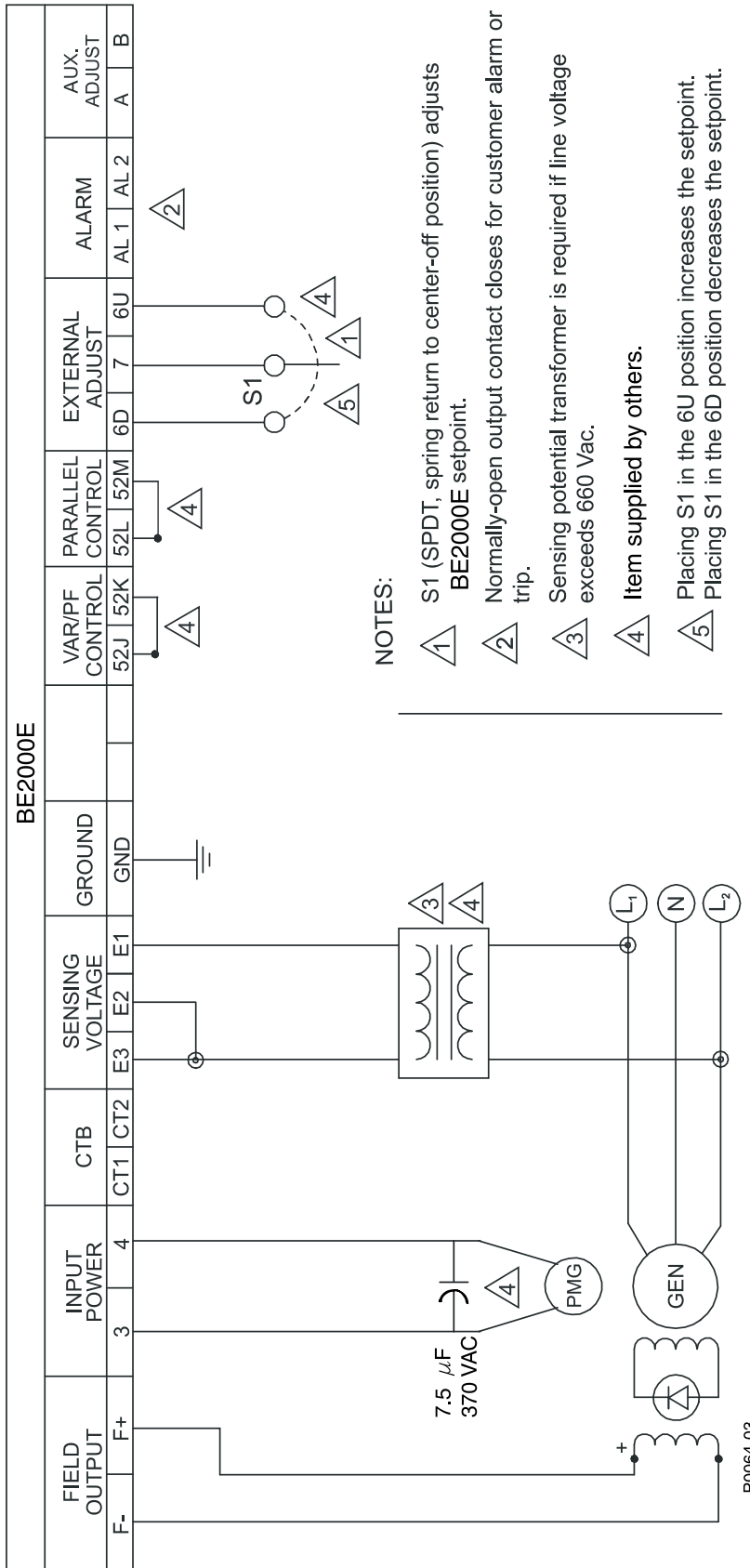

Figure 4-8. Typical Connections to a Single-Phase Generator

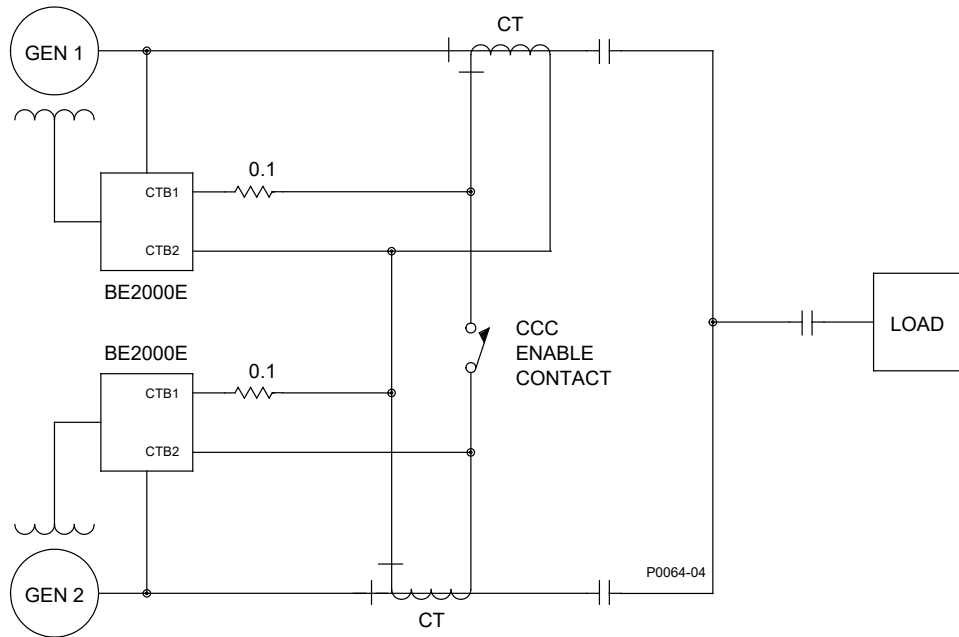

Figure 4-9. Cross-Current (Reactive Differential) Connections for Two Generators

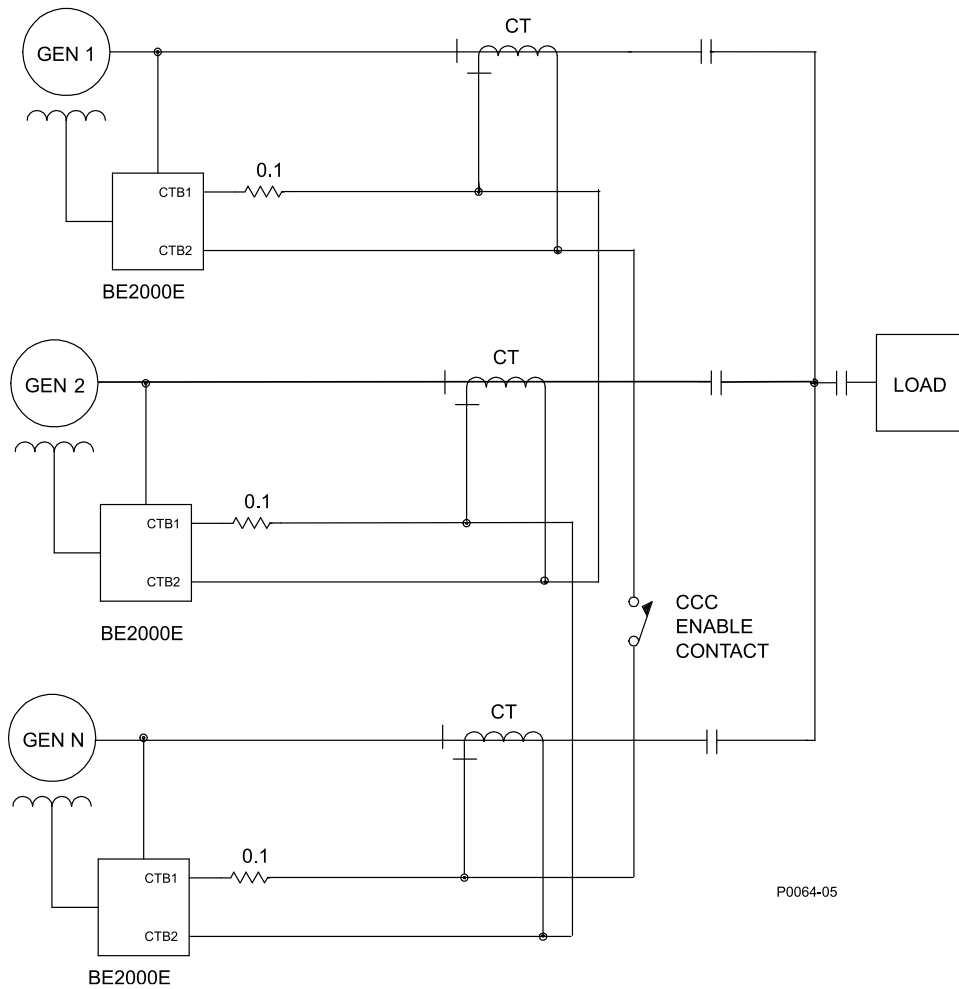

Figure 4-10. Cross-Current (Reactive Differential) Connections for Three or More Generators

Preliminary Setup

Before starting the generator and BE2000E for the first time, proceed as follows.

Warning!

Use caution when working around the rear of the BE2000E. Dangerous voltage levels are present at the exposed heatsinks when the unit is energized.

1. Tag and disconnect all wiring to the BE2000E. Be sure to insulate the wire terminals to prevent a short.
2. Start the prime mover and perform all engine governor adjustments.
3. After all initial governor adjustments have been made, shut down the prime mover.
4. Connect *only* the power input terminals of the BE2000E to an auxiliary power source in the specified power input range. An ICRM (Inrush Current Reduction Module) may be required.
5. Perform all initial BE2000E settings by using the front panel HMI, connecting a handheld operating with BESTCOMS™-BE2000E software, or connecting a PC operating with BESTCOMS-BE2000E to the rear communications port of the BE2000E.
6. Connect the rest of the BE2000E leads using the tagged identification.
7. Start the prime mover/generator and perform the final adjustments at rated speed and load.
8. After the initial startup, the BE2000E should not require any further adjustments unless there is a change in the system.

Adjustments

All adjustments are made using external switching, the front panel HMI or with BE2000E software via the rear panel communication port. See the *BESTCOMS Software* chapter for more information about making adjustments with BESTCOMS-BE2000E.

Storage

This device contains long-life aluminum electrolytic capacitors. For devices that are not in service (spares in storage), the life of these capacitors can be maximized by energizing the device for 30 minutes once per year.



5 • BESTCOMS™ Software

BESTCOMS-BE2000E provides a communication link between the BE2000E and the user. This software enables the user to enter all BE2000E settings and read all system metering values through an easy to use graphical interface. PID (Proportional + Integral + Derivative) software within the application enables the user to establish proper PID parameters based on a specified generator and/or exciter time constants. Within BESTCOMS-BE2000E, unit settings can be saved in a computer file and used later to configure other units with the same settings.

Caution

This product contains one or more *nonvolatile memory* devices. Nonvolatile memory is used to store information (such as settings) that needs to be preserved when the product is power-cycled or otherwise restarted. Established nonvolatile memory technologies have a physical limit on the number of times they can be erased and written. In this product, the limit is 10,000 erase/write cycles. During product application, consideration should be given to communications, logic, and other factors that may cause frequent/repeated writes of settings or other information that is retained by the product. Applications that result in such frequent/repeated writes may reduce the useable product life and result in loss of information and/or product inoperability.

Installation

BESTCOMS-BE2000E operates with systems using Windows® XP, Vista (32-bit only), 7 (32-bit & 64-bit), 8 (32-bit & 64-bit), and 10. The minimum recommended operating requirements are listed below:

- IBM compatible PC, 1.0 GHz or faster
- 256 MB RAM
- CD-ROM drive
- One available serial port

Installing BESTCOMS™-BE2000E

BESTCOMS-BE2000E software contains a setup utility that installs the program on your PC. An uninstall utility is loaded with the program that can be used to remove the software from your PC if desired. Use the following procedure to install BESTCOMS-BE2000E.

1. Insert the CD-ROM into the PC CD-ROM drive.
2. When the BESTCOMS Setup and Documentation CD menu appears, click the *Install* button for the BESTCOMS application. The setup utility automatically installs BESTCOMS-BE2000E on your PC.

When the software is installed, a Basler Electric folder is added to the Windows® program menu. This folder is accessed by clicking the *Start* button and pointing to *Programs*. The Basler Electric folder contains icons for the BESTCOMS for BE2000E program and a BESTCOMS for BE2000E uninstall utility.

Connecting the BE2000E and PC

Connect a communication cable between the rear RS-232 connector of the BE2000E and the appropriate communication port of the PC. Refer to the *Installation* chapter for the location of the BE2000E RS-232 connector and for the required connections between the BE2000E and a PC.

Starting the BESTCOMS™-BE2000E Application

The BESTCOMS-BE2000E application is started by clicking the Windows® *Start* button, pointing to Programs, the Basler Electric folder, and then clicking the BESTCOMS for BE2000E icon. At startup, a splash screen with the program title and version number is displayed briefly (Figure 5-1). After this dialog box is displayed, the *System Configuration* screen is displayed (Figure 5-2).



Figure 5-1. BESTCOMS-BE2000E - Splash Screen

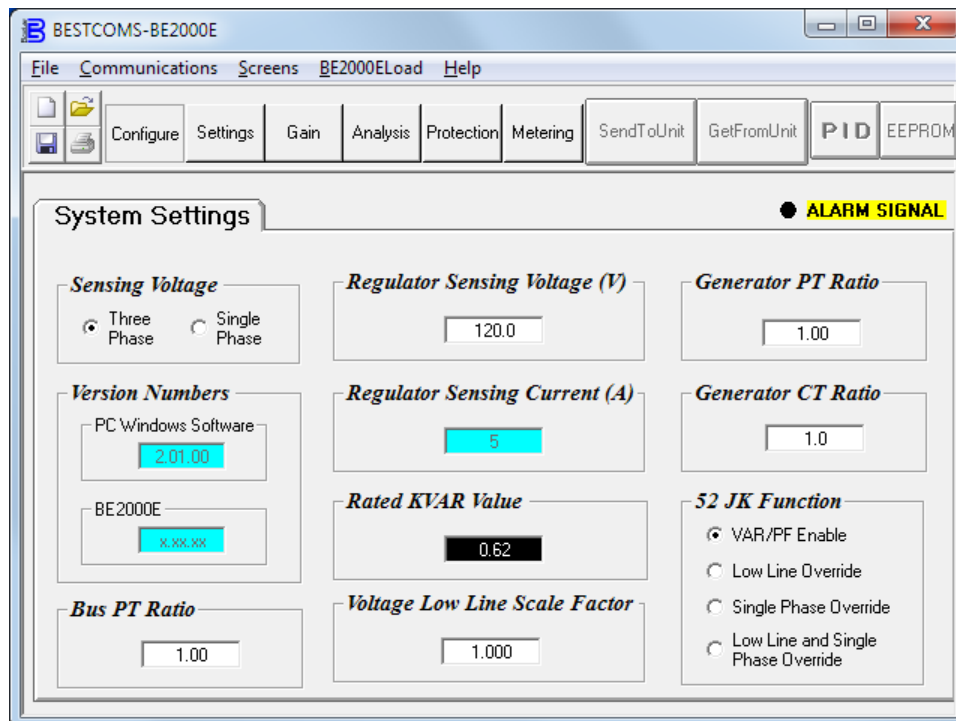

Figure 5-2. System Configuration Screen

Initial Adjustments

Caution

Read and understand the operation of the individual adjustments before attempting any initial adjustments.

Before starting the generator, the procedures in the following paragraphs should be performed.

Remove the 5-ampere fuse before starting the generator for the first time. Perform all preliminary engine governor adjustments without the regulator energized.

After initial governor adjustments are complete, reinstall the 5-ampere fuse, and connect only the power input leads or PMG leads to the regulator. Remove all other regulator connections that may be present and temporarily insulate them.

Start and run the generator at rated speed. The regulator will perform the self-test and enter a shutdown mode. At this time, initial adjustments can be made.

After the initial adjustments are made, shut down the generator and connect the remaining regulator leads. The generator may be started and final adjustments may be performed on the regulator.

Establishing Communication

Communication between BESTCOMS-BE2000E and the BE2000E must be established before viewing metering values or reading or changing settings. BESTCOMS-BE2000E screen settings are updated only after communication is opened or the communication settings have been changed.

Open the BE2000E communication port by clicking on *Communications* on the menu bar, hovering the mouse pointer over *Open Comm Port*, and clicking *RS-232 Port*. Figure 5-3 illustrates the menu selections for opening the BE2000E communication port.

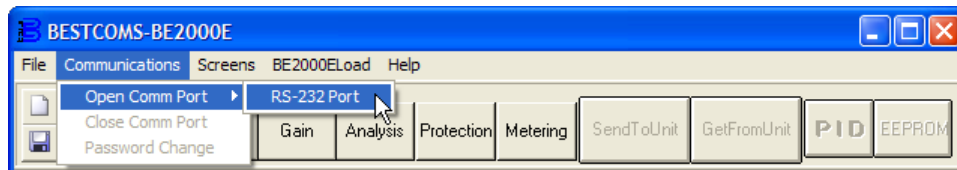

Figure 5-3. Communications Port Menu Selection

When RS-232 Port is selected, the Password dialog box of Figure 5-4 appears and prompts you to enter a password. Each BE2000E is delivered with "OEM" as the default password. See the *Password Protection* sub-section for information about changing the password.

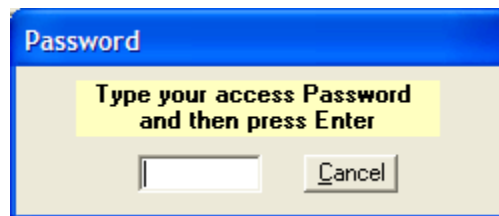

Figure 5-4. Password Dialog Box

After the correct password is entered, the *Communication Initialization* screen of Figure 5-5 is displayed. Select Com 1, Com 2, Com 3, or Com 4 as the active communication port on your PC and click the *Initialize* button. BESTCOMS-BE2000E initializes communication by obtaining the configuration settings from the BE2000E.

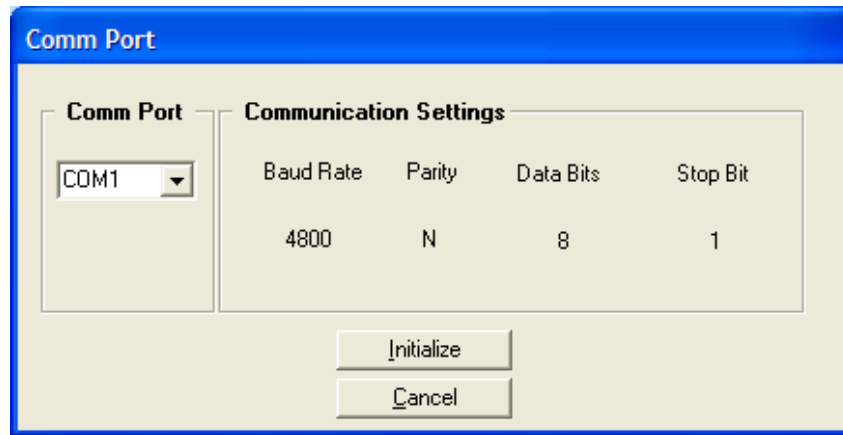

Figure 5-5. Communication Initialization Screen

Changing Settings

Caution

Do not disconnect the communications cable while the BE2000E and PC are communicating.

Settings are arranged into six groups:

- System Configuration
- Setting Adjustments
- Control Gain
- Analysis
- Protection Settings
- Metering, Operation, and Alarms

Note

BESTCOMS-BE2000E may display the dialog box of Figure 5-6 when initializing BE2000E communication, obtaining BE2000E configuration settings or performing other tasks. It's important to wait until the box disappears before trying to execute communication commands. Issuing commands while the Wait dialog box is present may disrupt communication between BESTCOMS-BE2000E and the BE2000E.

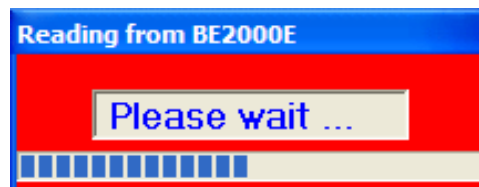

Figure 5-6. Wait Dialog Box

Each setting group has a corresponding button that can be selected to access that group of settings. The six setting groups can also be accessed by clicking *Screens* on the menu bar and then selecting the desired setting group from the list. Once a setting group is accessed, the individual settings of the group can be viewed and changed.

A setting is changed by clicking within the setting field and typing the new setting. The range limit of a setting can be viewed by double-clicking the setting. Any setting changes made on a setting group screen must be sent to the BE2000E before viewing other screens. Otherwise, the setting changes will be lost. A single setting change can be sent to the BE2000E by pressing the *Enter* key on your PC keyboard. Multiple setting changes can be sent to the BE2000E by clicking the *SendToUnit* button. Settings can also be sent to the BE2000E by clicking *Communications* on the menu bar and clicking *Send To Unit*.

Sending and Receiving Settings

When communication is enabled, BE2000E settings can be sent or received through BESTCOMS-BE2000E.

Sending Settings

Settings changes are sent to the BE2000E by clicking the *SendToUnit* button. This causes the settings displayed on the current settings screen to become the BE2000E settings. Settings can also be sent to the BE2000E by clicking *Communications* on the menu bar and clicking *Send To Unit*. Individual setting changes can be sent to the BE2000E by pressing the *Enter* key on your PC keyboard after changing the setting.

Receiving Settings

BE2000E settings are retrieved by clicking the *GetFromUnit* button. This causes the BE2000E settings to be displayed on the settings screen. Settings can also be received from the BE2000E by clicking *Communications* on the menu bar and clicking *Get From Unit*.

Saving Settings to BE2000E Memory

Settings are saved in nonvolatile memory (EEPROM). In the event of a power loss, these are the settings that are active at power up. If settings are changed and sent to the BE2000E but not sent to EEPROM, the changed settings are lost if BE2000E operating power is lost. When exiting BESTCOMS-BE2000E or closing communication, you are asked if you want to save the settings to EEPROM. This question is asked even if no settings changes were made.

When communication is enabled, setting changes are saved to EEPROM by clicking the EEPROM button. The opportunity to save settings to EEPROM is also given through a dialog box when exiting BESTCOMS-BE2000E or closing communication.

Setting Definitions

Each of the six setting groups has a corresponding BESTCOMS-BE2000E screen. The settings of each screen are categorized by one or more tabs. In the following paragraphs, settings are arranged and defined according to the organization of the BESTCOMS-BE2000E screens and tabs.

System Configuration

The *System Configuration* screen consists of one tab labeled *System Settings*. Click the *Configure* button to access the *System Configuration* screen or click *Screens* on the menu bar and click *System Configuration*.

System Settings

System settings are shown in Figure 5-7 and are described in the following paragraphs.

Sensing Voltage. This setting is used to configure the BE2000E for either single-phase or three-phase sensing voltage.

Version Numbers. These two version numbers are read-only. They indicate the BESTCOMS-BE2000E software version and the BE2000E embedded software version. If a BE2000E version number is not

shown, then the PC and software have not communicated with the BE2000E. The BE2000E version number is indicated only when communication between the BE2000E and BESTCOMS-BE2000E occurs.

Bus PT Ratio. The ratio of the bus sensing transformer is entered in this setting field. This ratio allows the voltage displayed through BESTCOMS-BE2000E to match the actual bus output voltage. A ratio of 1 to 150 may be entered in increments of 0.01

Regulator Sensing Voltage (V). The nominal generator line-to-line ac voltage obtained from the generator sensing transformer is entered in this setting field. Voltages within the ranges of 100 to 140 Vac, 200 to 280 Vac, or 340 to 560 Vac may be entered in 0.1 Vac increments. A setting of 600 Vac is also possible.

Regulator Sensing Current (A). This read-only field indicates the rated output of the current transformer (CT) that supplies the BE2000E with B-phase generator line current.

Rated KVAR Value. This read-only field displays the rated kvar value.

Voltage Low-Line Scale Factor. This setting defines the scale value applied to the voltage setpoint, the fine voltage adjust band limits, and the line voltage dependent protection thresholds when the 52JK input is configured as Low-Line Override.

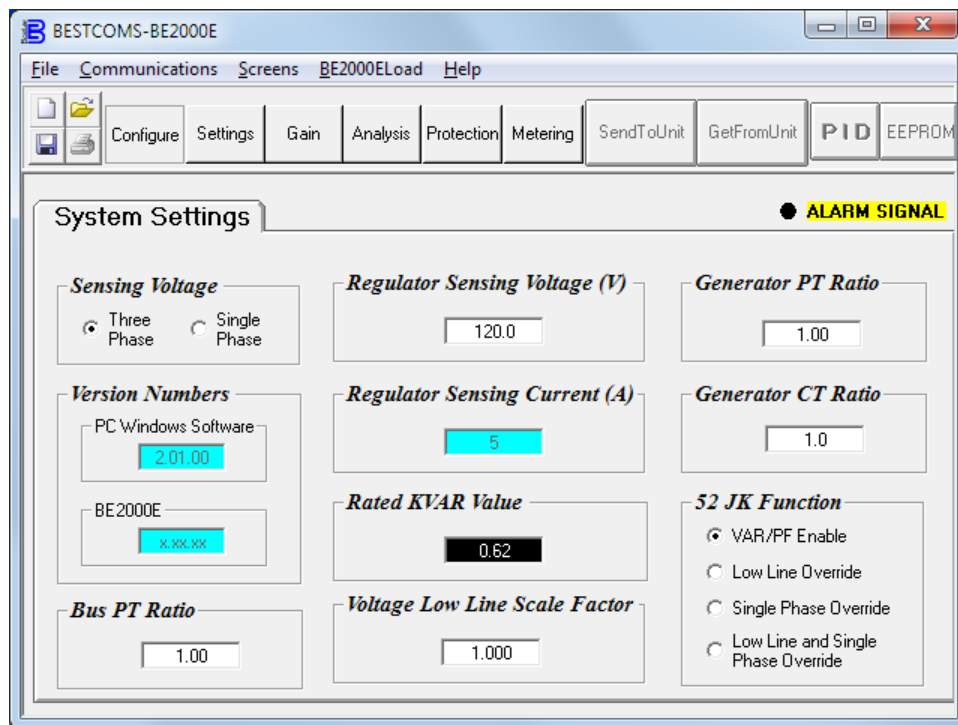

Figure 5-7. System Configuration Screen

Generator PT Ratio. The ratio of the generator sensing transformer is entered in this setting field. This ratio allows the voltage displayed through BESTCOMS-BE2000E to match the actual generator output voltage. A ratio of 1 to 150 may be entered in increments of 0.01.

Generator CT Ratio. The ratio of the generator B-phase current transformer is entered in this setting field. This ratio allows the current displayed by the BE2000E to match the actual B-phase generator output current. A ratio of 1 to 1,000 may be entered in increments of 0.1. Note: A 500:5 CT has a ratio of 100.

52 JK Function

VAR/PF Enable. This setting selects var or PF control mode. This is the default selection for the BE2000E.

Low-Line Override. When selected, the voltage setpoint, the fine voltage adjust band limits, and the line voltage dependent protection thresholds are scaled by the Voltage Low-Line Scale Factor setting.

Single-Phase Override. When selected, single-phase/three-phase sensing mode dependent protection is changed to single-phase mode. Phase imbalance monitoring for loss of sensing detection is disabled.

Low-Line and Single-Phase Override. When selected, both the low-line override and single-phase override functions operate simultaneously.

Setting Adjustments

The Setting Adjustments screen consists of three tabs: Setpoint, Startup, and Engine Unloading.

Setpoint Tab

The *Setpoint tab* settings of the *Setting Adjustments* screen are shown in Figure 5-8. Each setting of the *Setpoint* tab is described in the following paragraphs.

Automatic Voltage Regulator (AVR) - AVR Setpoint (V). This setting field is used to enter the desired generator output terminal voltage. The AVR setpoint value range depends on the regulator sensing voltage and band setting.

Fine Voltage Adjustment - Band Setting (%). The Band Setting determines the minimum and maximum adjustment allowed to the AVR Setpoint. This value is expressed as a percentage of the Regulator Sensing Voltage (see Figure 5-7). Band Setting values are entered as a percentage over a range of 0 to 15 percent in 0.1 percent increments.

Droop - Setpoint (%). This setting controls the reactive droop compensation feature of the BE2000E. The setpoint value is based on a 0.8 power factor load and determines the amount of change permitted in the generator voltage setpoint when the BE2000E responds to a reactive load. The setpoint value is adjustable from 0 to 10 percent in increments of 0.01 percent.

Field Current Regulator (FCR) - FCR Setpoint (A). This setting defines the field current setpoint when operating in Manual mode. The FCR Setpoint field accepts a value of 0 to 3 Adc in increments of 0.01 Adc.

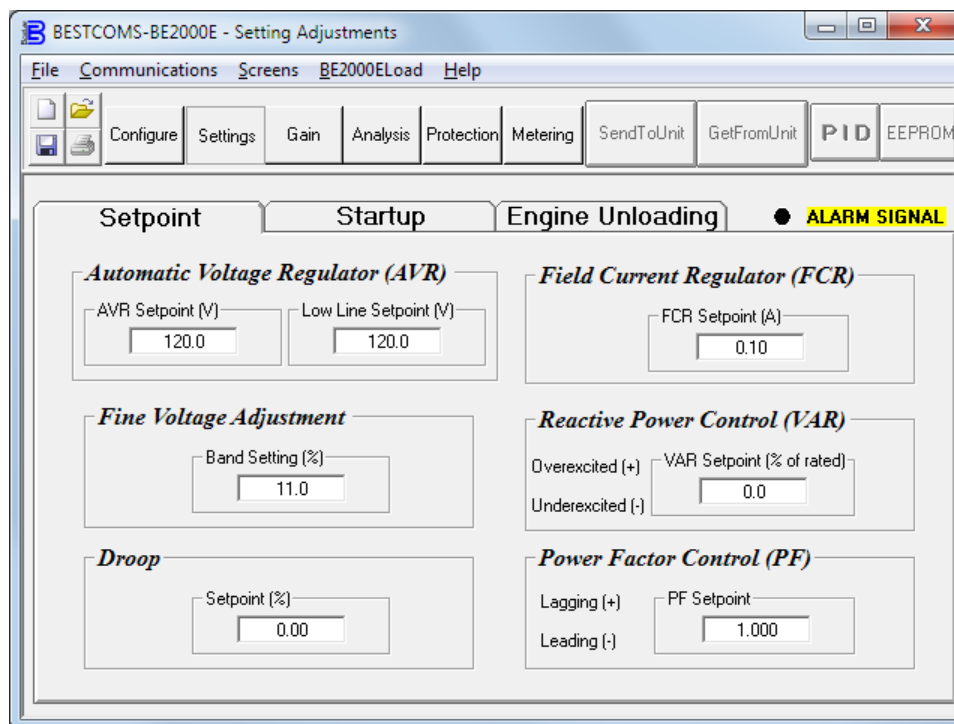

Figure 5-8. Setting Adjustments Screen, Setpoint Tab

Reactive Power Control (VAR) - VAR Setpoint (% of nom.). The VAR Setpoint determines the level of generator vars maintained by the BE2000E when operating in Var Control mode. Values from –100 to +100 percent in 1.0 percent increments may be entered in the VAR Setpoint field.

Power Factor Control (PF) - PF Setpoint. The PF Setpoint determines the level of generator power factor maintained by the BE2000E when operating in Power Factor Control mode. PF Setpoint values are adjustable from -0.6 to -1 (1) or 0.6 to $+1$ in 0.001 increments.

Startup Tab

The *Startup* tab settings of the *Setting Adjustment* screen are shown in Figure 5-9. Each setting of the *Startup* tab is described in the following paragraphs.

Startup Control - Gen Soft Start Time (sec). This setting defines the time limit for the generator soft-start voltage offset. The soft-start time can be set from 1 to 120 seconds in 1 second increments.

Underfrequency Setting - Corner Frequency (Hz). The Corner Frequency setting defines the value of frequency that causes the BE2000E to adjust the voltage setpoint so that the generator voltage follows the selected volts per hertz slope. A value of 40 to 65 hertz can be entered in this setting field in 0.01 increments.

Underfrequency Setting - Slope (Volts/Hz). The slope for generator underfrequency protection is selected with this setting. A slope setting of 1 to 3.00 can be entered in increments of 0.01 . The slope is a per-unit setting.

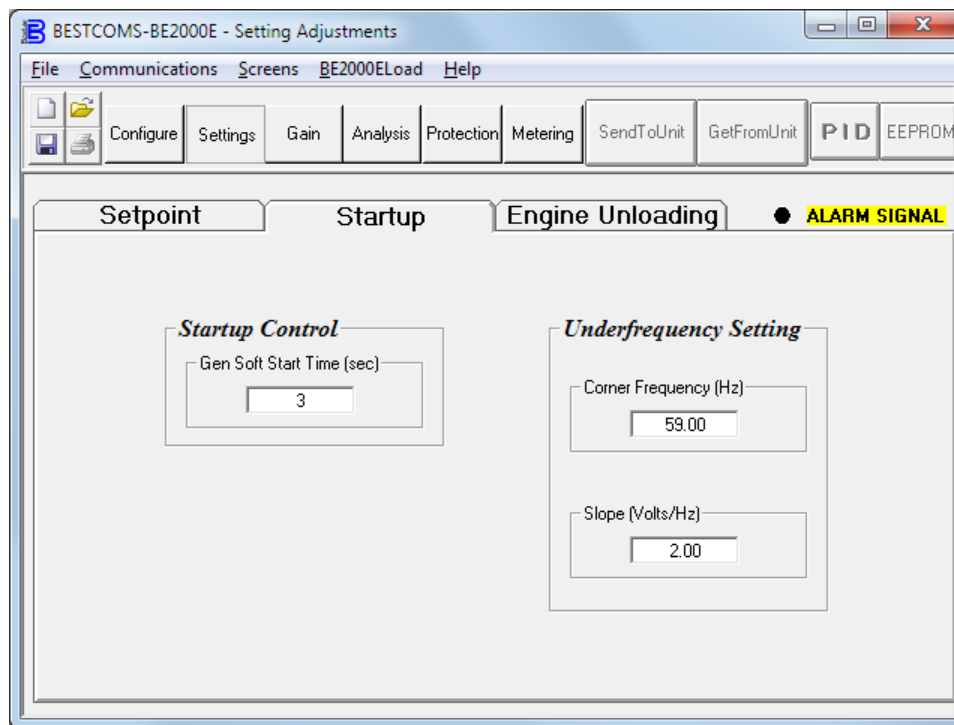

Figure 5-9. Setting Adjustments Screen, Startup Tab

Engine Unloading Tab

The *Engine Unloading* tab settings of the *Setting Adjustment* screen are shown in Figure 5-10. Each setting of the *Engine Unloading* tab is described in the following paragraphs.

Unloading Activation - Frequency (Hz).

This frequency is entered as a value below the underfrequency corner where the engine unloading feature may be activated. A frequency value of 0.9 to 9.0 Hz can be entered in 0.1 Hz increments.

Unloading Activation - Rate (Hz/25 ms)

The engine unloading feature is activated when the frequency rate of change exceeds the setting of this field. An unloading activation rate of 0 to 25.5 Hz per 25 ms can be entered in 0.1 Hz per 25 ms increments.

Unloading Droop - Percentage (%)

The value in this field defines the percent drop in generator output voltage for each 1.5 percent decrease in generator frequency when operating in the Engine Unloading mode. The Unloading Droop Percentage is adjustable from 1 to 20 percent in 1 percent steps.

Unloading Droop - Time (sec)

This value defines the length of time that the Engine Unloading mode may be active before control is passed to the normal Underfrequency mode of operation. Droop time is adjustable from 1 to 5 seconds in 1 second increments.

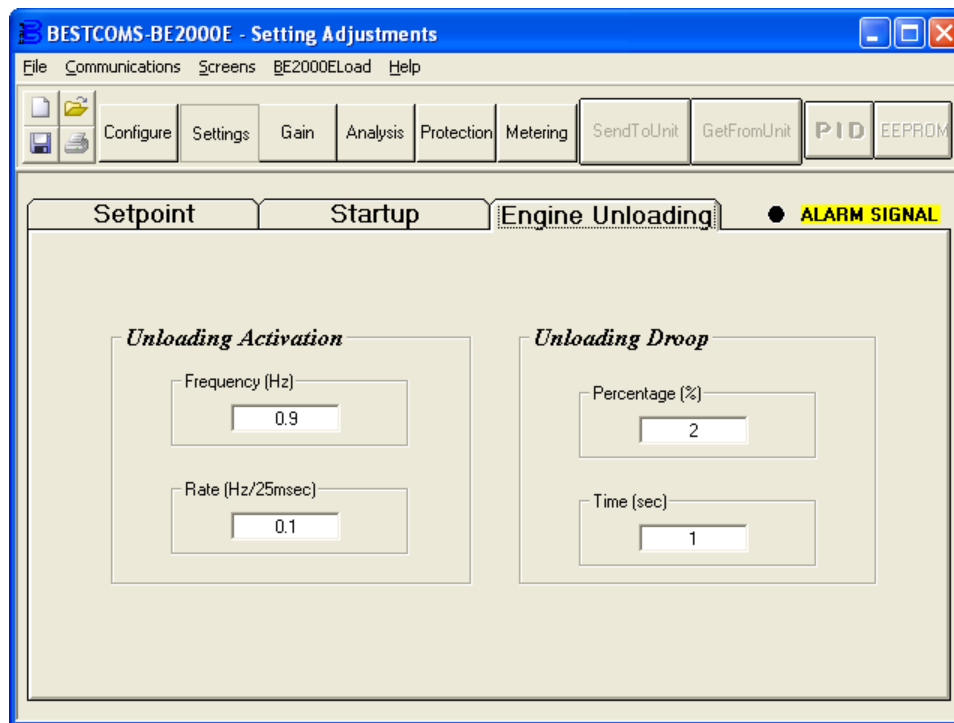

Figure 5-10. Setting Adjustments Screen, Engine Unloading Tab

Control Gain

The *Control Gain* screen consists of one tab labeled *Control Gain*. Click the *Gain* button to access the *Control Gain* screen or click *Screens* on the menu bar and click *Control Gain*.

Control Gain Tab

Control gain settings are shown in Figure 5-11 and are described in the following paragraphs.

Stability Range - This setting selects one of 7 preset stability ranges within the BE2000E. A guide for selecting the stability range is provided in Table 5-1. A setting of 21 enables the entry of custom stability settings through the BESTCOMS-BE2000E PID window. Information about the PID window is provided later under the heading of PID Window. When the Stability Range is set at 21, the PID button may be selected to access the PID window. A Stability Range setting of 1 through 7 disables the PID button and prevents access to the PID window.

Table 5-1. BE2000E Stability Range Settings

Frame/Poles	Time Constants		Stability Range
	Generator (T _{do})	Exciter (T _{exc})	
360/4	1.0	0.17	1
430/4	1.5	0.25	2
570/4	2.0	0.33	3
740/4	2.5	0.42	4

Frame/Poles	Time Constants		Stability Range
	Generator (T'do)	Exciter (Texc)	
1,000/4	3.0	0.50	5
740/6	3.5	0.58	6
1,000/6	4.0	0.67	7

AVR/FCR - Proportional Gain KP. This setting selects the proportional constant (KP) stability parameter. The BE2000E supplies a value that is equivalent to KP multiplied by the error between the voltage setpoint and the actual generator output voltage. KP values of 0 to 1,000 may be entered in increments of 0.01.

Observe the following guidelines when tuning the KP value. If the transient response has too much overshoot, then KP should be decreased. If the transient response is too slow, then KP should be increased.

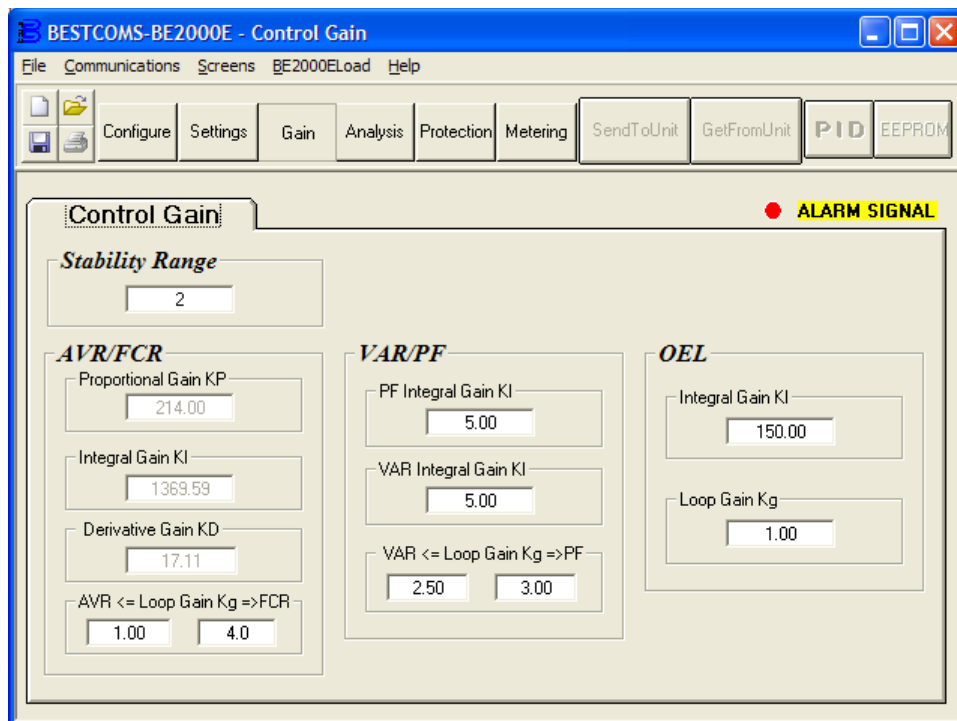

Figure 5-11. Control Gain Screen

AVR/FCR - Integral Gain KI. This setting selects the integral constant (KI) stability parameter. The BE2000E supplies a value that is equivalent to KI multiplied by the integral of the error between the voltage setpoint and the actual generator output voltage. KI values of 0 to 2,000 may be entered in increments of 0.01.

Increasing the value of KI decreases the time required to reach steady state.

AVR/FCR - Derivative Gain KD. This setting selects the derivative constant (KD) stability parameter. The BE2000E provides an output value that is equivalent to KD multiplied by the derivative of the error between the voltage setpoint and the actual generator output voltage. KD values of 0 to 1,000 may be entered in increments of 0.01.

Increasing the value of KD reduces transient response ringing.

AVR/FCR - Loop Gain Kg=>AVR. This setting adjusts the loop-gain level of the PID algorithm for AVR. Loop Gain values of 0.5 to 4.5 may be entered for AVR operation in increments of 0.01.

AVR/FCR - Loop Gain Kg=>FCR. This setting adjusts the loop-gain level of the PID algorithm for FCR. Loop Gain values of 0 to 1,000 may be entered FCR operation in increments of 0.1.

VAR/PF - PF Integral Gain KI. This setting adjusts the integral gain and determines the characteristic of the BE2000E dynamic response to a changed PF setting. PF KI values of 0 to 1,000 may be entered in increments of 0.01.

VAR/PF - Var Integral Gain KI. This setting adjusts the integral gain and determines the characteristic of the BE2000E dynamic response to a changed var setting. Var KI values of 0 to 1,000 may be entered in increments of 0.01.

VAR/PF - VAR<=Loop Gain Kg=>PF. This setting adjusts the loop-gain level of the PI algorithm for var or power factor control. Loop Gain values of 0 to 1,000 may be entered for var and power factor operation in increments of 0.01.

OEL - Integral Gain KI. This setting controls the rate at which the BE2000E responds during an overexcitation event. KI values of 0 to 1,000 may be entered in increments of 0.01.

OEL - Loop Gain Kg. This setting adjusts the loop-gain level of the PID algorithm for the over-excitation limiting function. Loop Gain values of 0 to 1,000 may be entered in increments of 0.01.

Analysis

Click the *Analysis* button or click *Screens* on the menu bar and click *Analysis* to view the *Analysis* screen. The *Analysis* screen consists of four tabs: VAR, PF, AVR, and FCR. Each of the tabs displays four metered sensing values and has six alarm signal indicators. Metered sensing values include Vrms (rms voltage), Ifd (dc field current), reactive power (vars), and power factor (PF). Alarm signal indicators include Overexcitation Shutdown, Generator Overvoltage, Unit Overtemperature, Loss of Generator Sensing, Overexcitation Limiting, and Underfrequency Active.

The operating status and control mode of the BE2000E determine which tabs of the *Analysis* screen are enabled and can be accessed by the user. Table 5-2 lists the BE2000E operating status and control modes that enable the four tabs of the *Analysis* screen.

Table 5-2. Analysis Screen Tab Combinations

Control Mode	Operating Status	Tab Enabled
AVR	OFF	AVR
AVR	PF	AVR, PF
AVR	VAR	AVR, VAR
FCR	N/A	FCR

Control mode and operating status selections are made at the *Operation* tab of the BESTCOMS-BE2000E *Metering* screen and are discussed later in this chapter.

AVR Tab

Figure 5-12 illustrates the settings, sensing values, and alarm signal indicators of the *AVR* tab. The settings of the *AVR* tab make it possible to increment and decrement the AVR setpoint of the BE2000E. The sensing values and alarm signal indicators of the *AVR* tab are also displayed by the other tabs of the *Analysis* screen.

Voltage Step Response - AVR Setpoint (V) (Nominal). This read-only field indicates the AVR setpoint. (The AVR setpoint is set by using the *Setpoint* tab of the *Setting Adjustments* screen). The voltage displayed in the AVR Setpoint field is selected by clicking the adjacent button. Clicking this button sends the AVR Setpoint value to the BE2000E and changes the color of the button from gray to red.

Voltage Step Response - Increment of AVR Setpoint (V). These two fields indicate the increase that occurs to the AVR setpoint when the corresponding Increment button is clicked. The "% increase" field is used to set and indicate the percentage that the AVR setpoint is increased when the Increment button is clicked. The "AVR Setpoint =" field indicates the value of voltage that corresponds to the "% increase" field. Any setpoint value within range and higher than setpoint value be can also be typed into the "AVR Setpoint =" field which updates the "% increase" field also. The AVR setpoint changes to this value when the adjacent button is clicked. When clicked, the Increment button changes from gray to red to indicate that the AVR setpoint has increased to the value in the "AVR Setpoint =" field.

Voltage Step Response - Decrement of AVR Setpoint (V). These two fields indicate the change that will occur to the AVR setpoint when the corresponding *Decrement* button is clicked. The "% decrease" field is used to set and indicate the percentage that the AVR setpoint is decreased when the *Decrement* button is clicked. The "AVR Setpoint =" field indicates the value of voltage that corresponds to the "% decrease" field. Any setpoint value within range and lower than setpoint value can also be typed into the "AVR Setpoint =" field which updates the "% decrease" field also. The AVR setpoint changes to this value when the adjacent button is clicked. When clicked, the *Decrement* button changes from gray to red to indicate that the AVR setpoint has decreased to the value in the "AVR Setpoint =" field.

Voltage Step Response - Meter. The meter in the AVR tab shows the value selected. If an AVR setpoint value is sent by increase, decrease or setpoint button the meter shows the corresponding value and meter value text box also displays it. Any value within the range can either be input to meter value text box or selected by dragging the pointer in the meter using mouse. This value can then be sent to the unit by pressing *Send* button.

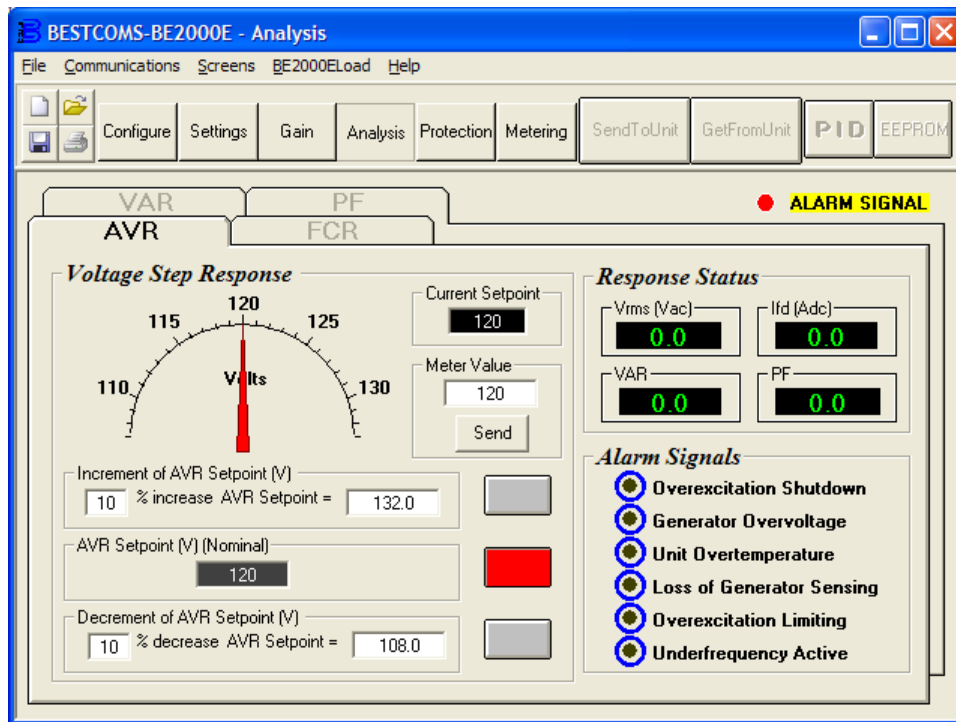

Figure 5-12. Analysis Screen, AVR Tab

The setpoint value currently set in the unit by any of the above methods is displayed in the current setpoint textbox. To return to the nominal setting, the button adjacent to *AVR Setpoint (V) (Nominal)* should be pressed. If the AVR *Analysis* screen is left without returning to nominal setpoint, a message box (Figure 5-13) is shown which allows the user to return to nominal setpoint by pressing *YES* or remain at the current setpoint by pressing *NO*.

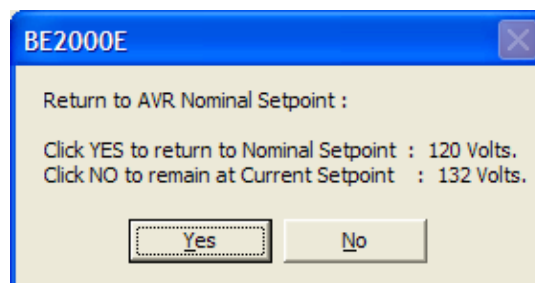

Figure 5-13. Message Box - Return to AVR Nominal Setpoint

FCR Tab

Figure 5-14 illustrates the settings, sensing values, and alarm signal indicators of the *FCR* tab. The settings of the *FCR* tab make it possible to increment and decrement the FCR setpoint of the BE2000E. The sensing values and alarm signal indicators of the *FCR* tab are also displayed by the other tabs of the *Analysis* screen.

Field Current Step Response - FCR Setpoint (A). This read-only field indicates the FCR setpoint. (The FCR setpoint is set by using the *Setpoint* tab of the *Setting Adjustments* screen). The current displayed in the FCR Setpoint field is selected by clicking the adjacent pushbutton. Clicking this button sends the FCR Setpoint value to the BE2000E and changes the color of the pushbutton from gray to red.

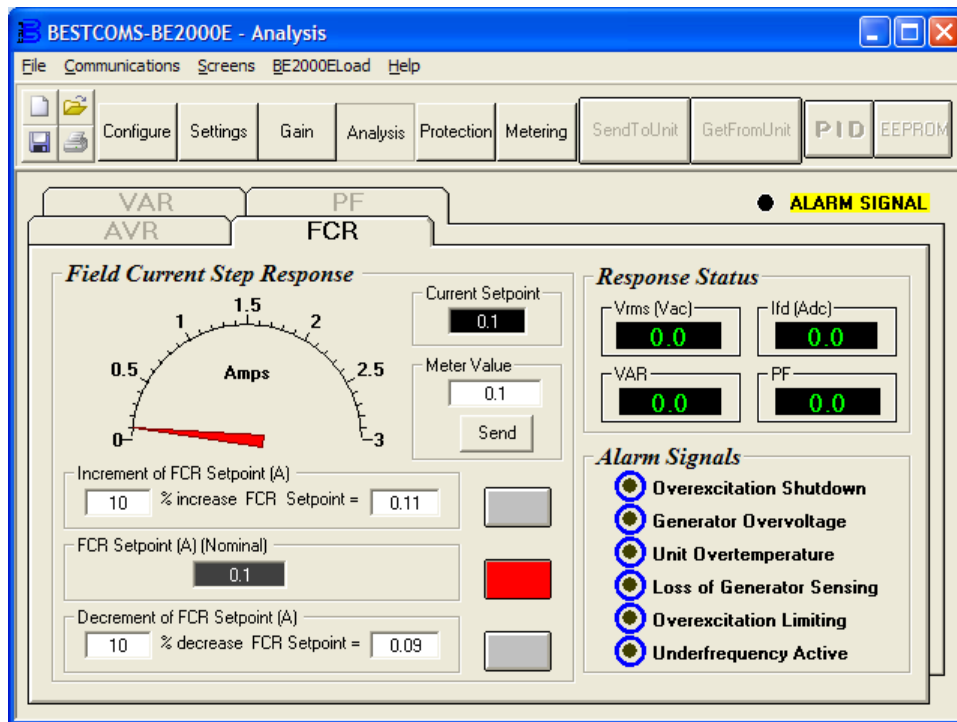

Figure 5-14. Analysis Screen, FCR Tab

Field Current Step Response - Increment of FCR Setpoint (A). These two fields indicate the increase that occurs to the FCR setpoint when the corresponding *Increment* button is clicked. The "% increase" field is used to set and indicate the percentage that the FCR setpoint is increased when the *Increment* button is clicked. The "FCR Setpoint =" field indicates the value of current that corresponds to the "% increase" field. Any setpoint value within range and higher than setpoint value can also be typed into The "FCR Setpoint =" field which updates the "% increase" field also. The FCR setpoint changes to this value when the adjacent button is clicked. When clicked, the *Increment* button changes from gray to red to indicate that the FCR setpoint has increased to the value in the "FCR Setpoint =" field.

Field Current Step Response - Decrement of FCR Setpoint (A). These two fields indicate the change that will occur to the FCR setpoint when the corresponding *Decrement* button is clicked. The "% decrease" field is used to set and indicate the percentage that the FCR setpoint is decreased when the *Decrement* button is clicked. The "FCR Setpoint =" indicates the value of current that corresponds to the "% decrease" field. Any setpoint value within range and lower than setpoint value can also be typed into The "FCR Setpoint =" field which updates the "% decrease" field also. The FCR setpoint changes to this value when the adjacent button is clicked. When clicked, the *Decrement* button changes from gray to red to indicate that the FCR setpoint has decreased to the value in the "FCR Setpoint =" field.

Field Current Step Response - Meter. The meter in the *FCR* tab shows the value selected. If an FCR setpoint value is sent by *increase*, *decrease* or *setpoint* button the meter shows the corresponding value and meter value text box also displays it. Any value within the range can either be input to meter value text box or selected by dragging the pointer in the meter, using mouse. This value can then be sent to the unit by pressing *Send* button.

The setpoint value currently set in the unit by any of the above methods is displayed in the current setpoint textbox. To return to the nominal setting the button adjacent to *FCR Setpoint (I) (Nominal)* should be pressed. If the *FCR Analysis* screen is left without returning to nominal setpoint a message box is shown (Figure 5-15) which allows the user to return to nominal setpoint by pressing *YES* or remain at the current setpoint by pressing *NO*.

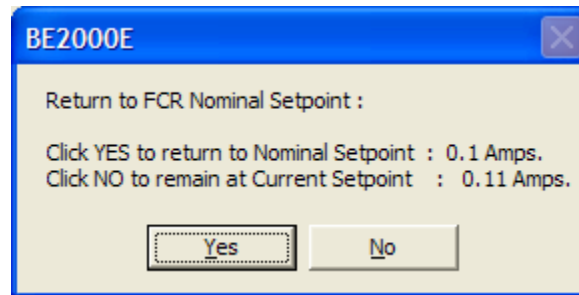

Figure 5-15. Message Box to Return to FCR Nominal Setpoint

PF Tab

Figure 5-16 illustrates the settings, sensing values, and alarm signal indicators of the *PF* tab. Each setting of the *PF* tab is described in the following paragraphs.

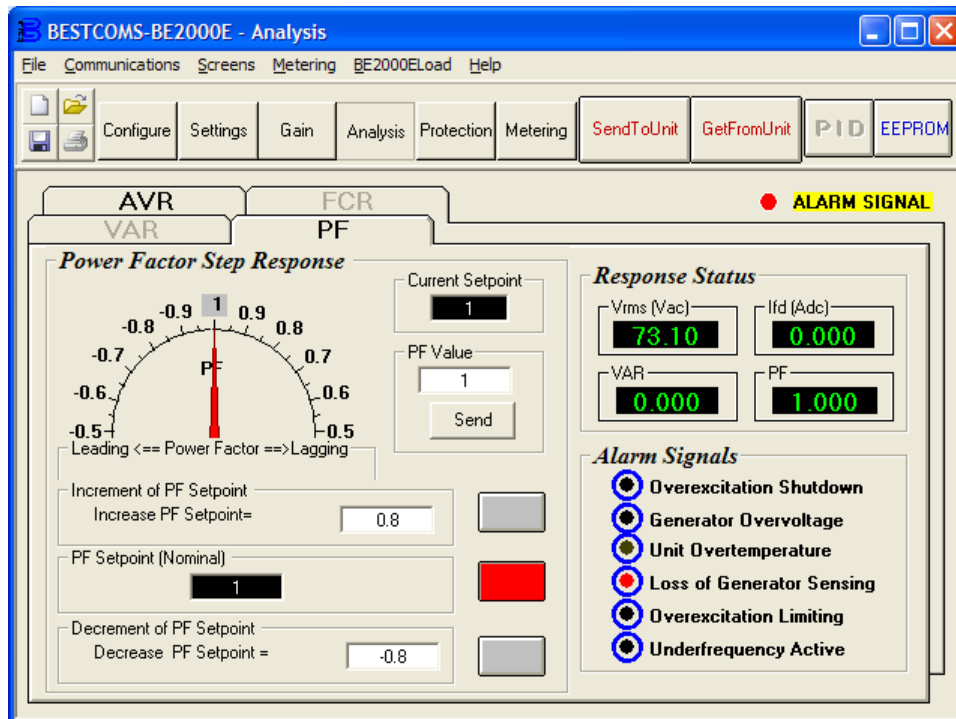

Figure 5-16. Analysis Screen, PF Tab

Power Factor Step Response - Power Factor Setpoint (Nominal). This read-only field indicates the PF setpoint. (The PF setpoint is set by using the *Setpoint* tab of the *Setting Adjustments* screen). The value displayed in the PF Setpoint field is selected by clicking the adjacent button. Clicking this button sends the PF Setpoint value to the BE2000E and changes the color of the button from gray to red.

Power Factor Step Response - Increment of PF setpoint. This field indicates the increase that occurs to the PF setpoint when the corresponding increment button is clicked. Any setpoint value within the range and higher than setpoint value can be input to this field. The PF setpoint changes to this value when the adjacent button is clicked. When clicked, the *Increment* button changes from gray to red to indicate that the PF setpoint has increased to the value in the field.

Power Factor Step Response - Decrement of PF setpoint. This field indicates the decrease that occurs to the PF setpoint when the corresponding *Decrement* button is clicked. Any setpoint value within the range

and lower than setpoint value can be input to this field. The PF setpoint changes to this value when the adjacent button is clicked. When clicked, the *Increment* button changes from gray to red to indicate that the PF setpoint has decreased to the value in the field.

Power Factor Step Response - Meter. The meter in the PF tab shows the value selected. If a PF setpoint value is sent by increase, decrease or setpoint button the meter shows the corresponding value and meter value text box also displays it. Any value within the range can either be input to meter value text box or selected by dragging the pointer in the meter using mouse. This value can then be sent to the unit by pressing *Send* button.

The setpoint value currently set in the unit by any of the above methods is displayed in the current setpoint textbox. To return to the nominal setting the button adjacent to *PF Setpoint (Nominal)* should be pressed. If the *PF Analysis* screen is left without returning to nominal setpoint a message box is shown (Figure 5-17) which allows the user to return to nominal setpoint by pressing *YES* or remain at the current setpoint by pressing *NO*.

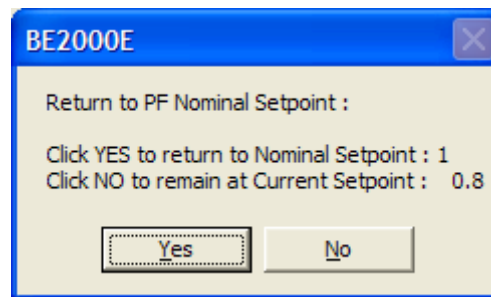

Figure 5-17. Message Box to Return to PF Nominal Setpoint

VAR Tab

Figure 5-18 illustrates the settings, sensing values, and alarm signal indicators of the VAR tab. Each setting of the VAR tab is described in the following paragraphs.

VAR Step Response - VAR Setpoint (Nominal). This read-only field indicates the VAR setpoint. (The VAR setpoint is set by using the *Setpoint* tab of the *Setting Adjustments* screen). The value displayed in the VAR Setpoint field is selected by clicking the adjacent button. Clicking this button sends the VAR Setpoint value to the BE2000E and changes the color of the button from gray to red.

VAR Step Response - Increment of VAR setpoint. This field indicates the increase that occurs to the VAR setpoint when the corresponding increment button is clicked. Any setpoint value within the range and higher than setpoint value can be input to this field. The VAR setpoint changes to this value when the adjacent button is clicked. When clicked, the *Increment* button changes from gray to red to indicate that the VAR setpoint has increased to the value in the field.

VAR Step Response - Decrement of VAR setpoint. This field indicates the decrease that occurs to the VAR setpoint when the corresponding decrement button is clicked. Any setpoint value within the range and lower than the setpoint value can be input to this field. The VAR setpoint changes to this value when the adjacent button is clicked. When clicked, the *Increment* button changes from gray to red to indicate that the VAR setpoint has decreased to the value in the field.

VAR Step Response - Meter. The meter in the VAR tab shows the value selected. If an VAR setpoint value is sent by increase, decrease or setpoint button the meter shows the corresponding value and meter value text box also displays it. Any value within the range can either be input to meter value text box or selected by dragging the pointer in the meter using mouse. This value can then be sent to the unit by pressing *Send* button.

The setpoint value currently set in the unit by any of the above methods is displayed in the current setpoint textbox. To return to the nominal setting the button adjacent to VAR Setpoint (Nominal) should be pressed. If the *VAR Analysis* screen is left without returning to nominal setpoint a message box (Figure 5-19) is shown which allows the user to return to nominal setpoint by pressing *YES* or remain at the current setpoint by pressing *NO*.

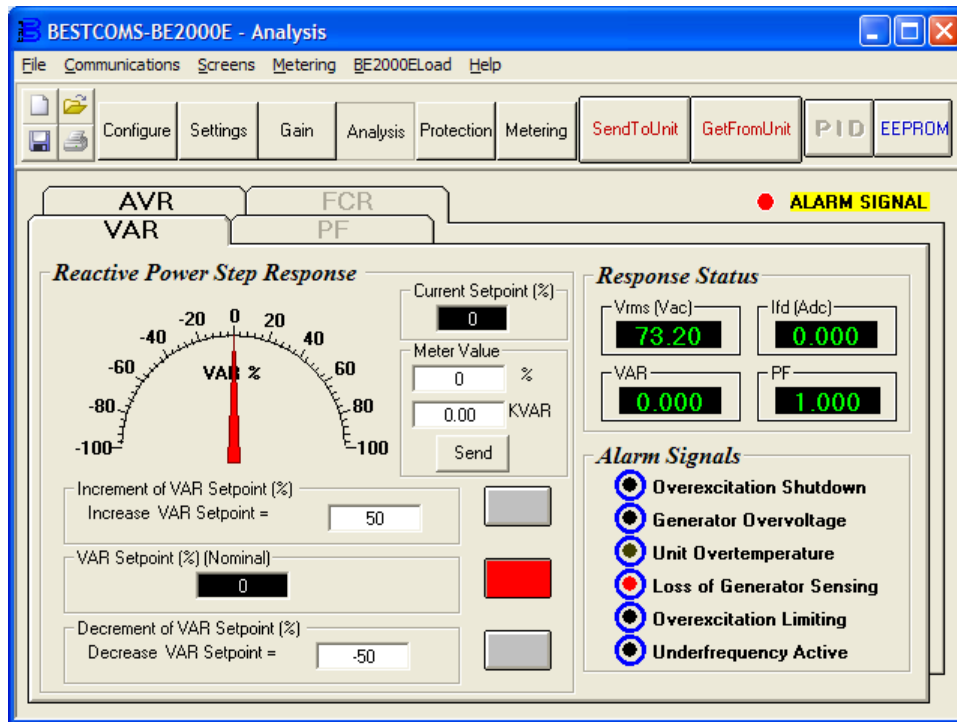

Figure 5-18. Analysis Screen, VAR Tab

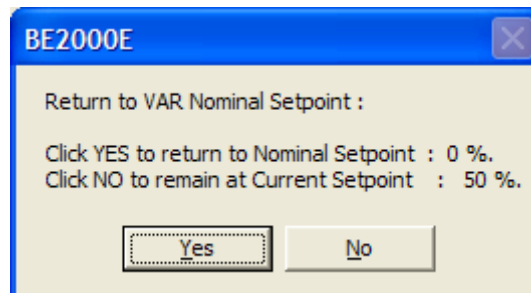

Figure 5-19. Message box to return to VAR Nominal Setpoint

Protection and Relay Settings

The *Protection and Relay Settings* screen consists of one tab labeled *Protection*. Click the *Protection* button to access the *Protection* screen or click *Screens* on the menu bar and click *Protection/Relay*.

Protection Tab

Protection settings are shown in Figure 5-20 and are described in the following paragraphs.

OEL - Current Level (A). The value of current in this field determines the excitation level that will cause the BE2000E to issue an overexcitation limit alarm. A current level of 0 to 7.5 A may be entered in 0.001 increments. When the level of field current increases above the value of this field, the OVEREXCITATION SHUTDOWN LED on the front panel lights and the OEL time delay starts timing down.

OEL - Alarm Time Delay (sec). The value of this field determines the time delay between when the BE2000E recognizes an overexcitation condition and the BE2000E Alarm output (terminals AL1, AL2) closes. A time delay of 0 to 10 seconds may be entered in 1 second increments.

Field Overvoltage - Voltage Level (Vdc). The voltage value in this field determines the field voltage level that will cause the BE2000E to issue an overexcitation limit alarm. When the field voltage increases above the value of this field, the OVEREXCITATION SHUTDOWN LED on the front panel lights. If the alarm condition exists for more than 15 seconds, the BE2000E Alarm output (terminals AL1, AL2) closes.

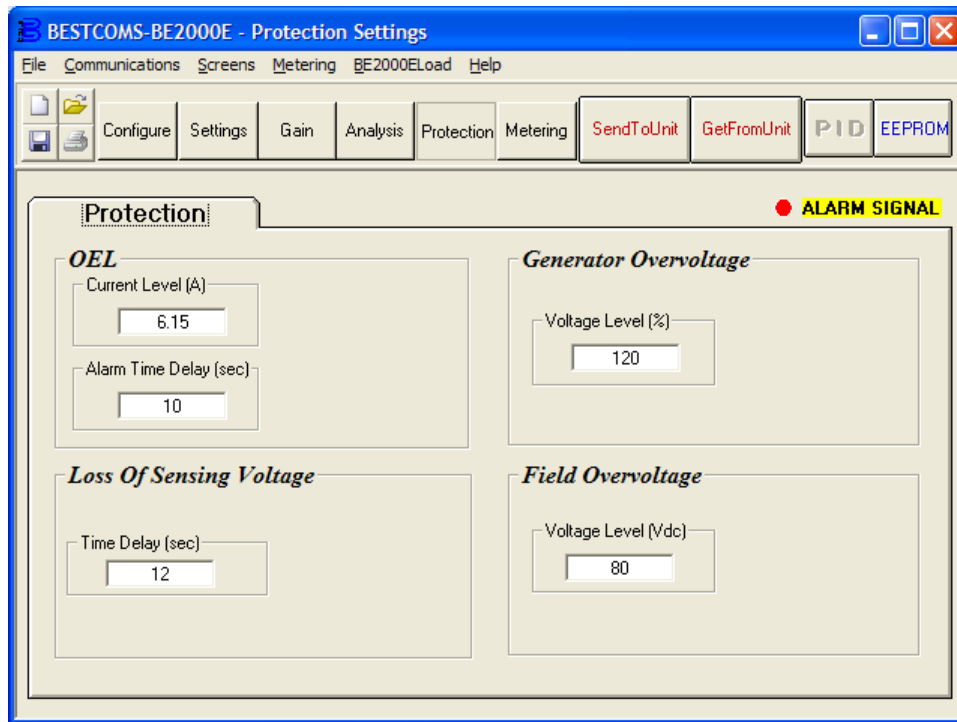

Figure 5-20. Protection Settings Screen

Loss of Sensing Voltage - Time Delay (sec). The value of this field determines the time delay between when a loss of sensing voltage is recognized and the BE2000E responds according to the Hardware Shutdown and LOS Option options selected. A time delay of 0 to 25 seconds may be entered in 1 second increments.

Generator Overvoltage - Voltage Level (%). The value of this field is expressed as a percentage and determines the level of generator voltage required to initiate a generator overvoltage condition. An overvoltage percentage value of 105 to 120 percent may be entered in 1 percent increments. A generator overvoltage condition lights the GENERATOR OVERVOLTAGE LED on the front panel and closes the Alarm output at BE2000E terminals AL1 and AL2 after a delay of 0.75 seconds.

Metering, Operation and Alarms

The *Metering, Operation and Alarms* screen is viewed by clicking the *Metering* button or by clicking *Screens* on the menu bar and clicking *Metering/Operation*. Information displayed on the *Metering, Operation and Alarms* screen can be frozen by clicking the *Metering* button while viewing the screen or by clicking *Metering* on the menu bar and clicking *Disable Metering*. Metering can be resumed by clicking the *Metering* button or by clicking *Metering* on the menu bar and clicking *Enable Metering*. The *Metering, Operation and Alarms* screen consists of two tabs: *Operation* and *Alarm/Status*.

Operation Tab

Operation tab metering values, setpoint values and control functions are illustrated in Figure 5-21.

Gen Voltage (V). These metering values report the status of the V_{A-B} , V_{C-B} , V_{C-A} , and V_{AVG} generator voltages and are the products of the voltage sensed at terminals E1, E2, and E3 and the Generator PT ratio. All metering values are updated once each second. When single-phase sensing is used (*System Configuration* screen, Sensing Voltage) and the BE2000E sensing voltage terminals (E1, E2, and E3) are connected as shown in the *Installation* chapter, all of the generator voltage metering values will be identical.

Gen Current (A). This metering value indicates the level of the B-phase generator current and is the product of the current input to CT1 and CT2 and the CT ratio. Generator current is monitored through BE2000E terminals CT1 and CT2.

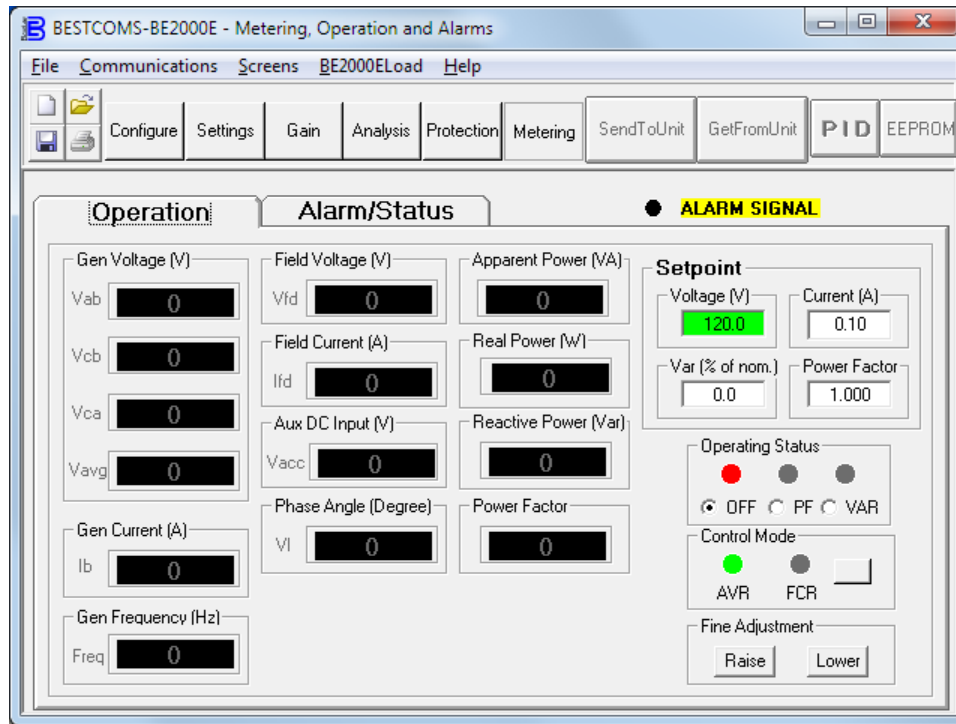

Figure 5-21. Metering, Operation and Alarms - Operation Tab

Gen Frequency (Hz). This metering value indicates the frequency of the monitored generator voltage.

Field Voltage (V). This metering value indicates the value of voltage being supplied from the BE2000E output (terminals F+ and F-) to the generator field.

Field Current (A). This metering value indicates the amount of current flowing from the BE2000E output (terminals F+ and F-) to the generator field.

Aux DC Input (V). This metering value indicates the level of dc control voltage applied from a remote device to BE2000E terminals A and B. The displayed value correlates to the generator voltage setpoint.

Phase Angle (Degree). This metering value indicates the phase angle difference (in degrees) between the generator voltage and the generator current.

Apparent Power (VA). This value is the calculated product of the metered generator voltage (V_{AVG}), metered generator current (I_B), and the square root of 3. See Equation 5-1.

$$VA = V_{AVG} \times I_B \times \sqrt{3}$$

Equation 5-1. Apparent Power Equation

Real Power (W). This value is the calculated product of the metered generator voltage (V_{AVG}), metered generator current (I_B), square root of 3 and the cosine of the metered phase angle. See Equation 5-2.

$$W = V_{AVG} \times I_B \times \sqrt{3} \times \cos\Phi$$

Equation 5-2. Real Power Equation

Reactive Power (var). This value is the calculated product of the metered generator voltage (V_{AVG}), metered generator current (I_B) square root of 3 and the sine of the metered phase angle. See Equation 5-3.

$$VAR = V_{AVG} \times I_B \times \sqrt{3} \times \sin\Phi$$

Equation 5-3. Reactive Power Equation

Power Factor. This value is the calculated result of dividing the Real Power (W) value by the Apparent Power (VA) value. See Equation 5-4.

$$PF = W \div VA = \text{COS}\Phi$$

Equation 5-4. Power Factor Equation

Operating Status. The Operating Status controls and indicators include three buttons and three corresponding indicators. Operating Status buttons are labeled PF, VAR, and OFF. Clicking the *PF* button changes the color of the adjacent PF indicator to green and causes the BE2000E to maintain the desired power factor regulation point. The power factor regulation point can be set within the range of 0.6 lead to 0.6 lag. Clicking the *VAR* button changes the color of the adjacent VAR indicator to green and causes the BE2000E to maintain the desired var regulation point. The var regulation point can be set within the range of 100 percent absorb to 100 percent generate. Clicking the *OFF* button changes the color of the adjacent OFF indicator to red and disables power factor and var regulation.

Operation of the Operating Status controls is determined by the status of the contacts connected across the BE2000E Var/PF Control terminals (52J, 52K). When these contacts are open, the Operating Status controls are enabled. Closing the contacts at terminals 52J and 52K disables the Operating Status controls and interrupts regulation of vars or power factor until the contacts are opened again.

Setpoint - Voltage (V). This setting field can be used to enter the desired generator output terminal voltage. The voltage setpoint can also be entered at the *Setting Adjustments* screen, *Setpoint* tab, Automatic Voltage Regulator (AVR) - AVR Setpoint (V). The background color of this field is green when operating in AVR mode and power factor and var regulation is disabled.

Setpoint - Current (A). This setting defines the field current setpoint when operating in FCR mode. The current setpoint can also be entered at the *Setting Adjustments* screen, *Setpoint* tab, Field Current Regulator (FCR) - FCR Setpoint. Current values from 0 to 3 Adc may be entered in increments of 0.01 Adc. The background color of this field is green when operating in FCR mode.

Setpoint - Var (% of nom.). This setting determines the level of generator vars maintained by the BE2000E when operating in var mode. The var setpoint can also be entered at the *Setting Adjustments* screen, *Setpoint* tab, Reactive Power Control (VAR) - VAR Setpoint (% of nom.). The background color of this field is green when the BE2000E is operating in AVR mode and is regulating the var setpoint.

Setpoint - Power Factor. This setting determines the level of power factor regulation maintained by the BE2000E. The power factor setpoint can also be entered at the *Setting Adjustments* screen, *Setpoint* tab, Power Factor Control (PF) - PF Setpoint. Power Factor setpoint values are adjustable from -0.6 to -1 (1) or 0.6 to +1 in 0.001 increments. The background color of this field is green when the BE2000E is operating in AVR mode and is regulating the power factor setpoint.

Control Mode. Clicking the *AVR* button changes the color of the adjacent AVR indicator to green and enables the AVR operating mode. When operating in AVR mode, the BE2000E regulates the generator output voltage at the AVR setpoint. Clicking the *FCR* button changes the color of the adjacent FCR indicator to green and enables the FCR operating mode. When operating in FCR mode, the BE2000E maintains the field current at the FCR setpoint.

Fine Adjustment. *Raise* and *Lower* buttons control the fine adjustment of the operating setpoint. (The fine adjustment through the front panel push buttons only controls the voltage setpoint.) *Raise* and *Lower* buttons perform the same function as closing the appropriate set of contacts connected to the External Adjust terminals (6D and 7 to decrease, 6U and 7 to increase) of the BE2000E. In AVR mode, each click of the *Raise* button increases the voltage setpoint 0.01 volts; each click of the *Lower* button decreases the voltage setpoint 0.01 volts. The minimum and maximum limits for fine adjustment of the voltage setpoint are controlled by the Regulator Sensing Voltage setting (*System Configuration* screen) and the Fine Voltage Adjustment - Band setting (*Setting Adjustments* screen). Fine adjustment of the voltage setpoint can be increased/decreased no higher/lower than the Regulator Sensing Voltage setting plus/minus the Band setting. For example, a Regulator Sensing Voltage setting of 100 volts and a Band setting of 10 percent allows the Fine Adjustment function to increase the voltage setpoint to a maximum of 110 volts and decrease the voltage setpoint to a minimum of 90 volts. For VAR, PF or FCR modes, the *Raise* and *Lower* buttons allow fine adjustment over the entire adjustment range.

Alarm/Status Tab

The *Alarm/Status* tab indicators provide the status of BE2000E protection functions, control modes, and contact inputs. *Alarm/Status* tab indicators are illustrated in Figure 5-22 and are described in the following paragraphs.

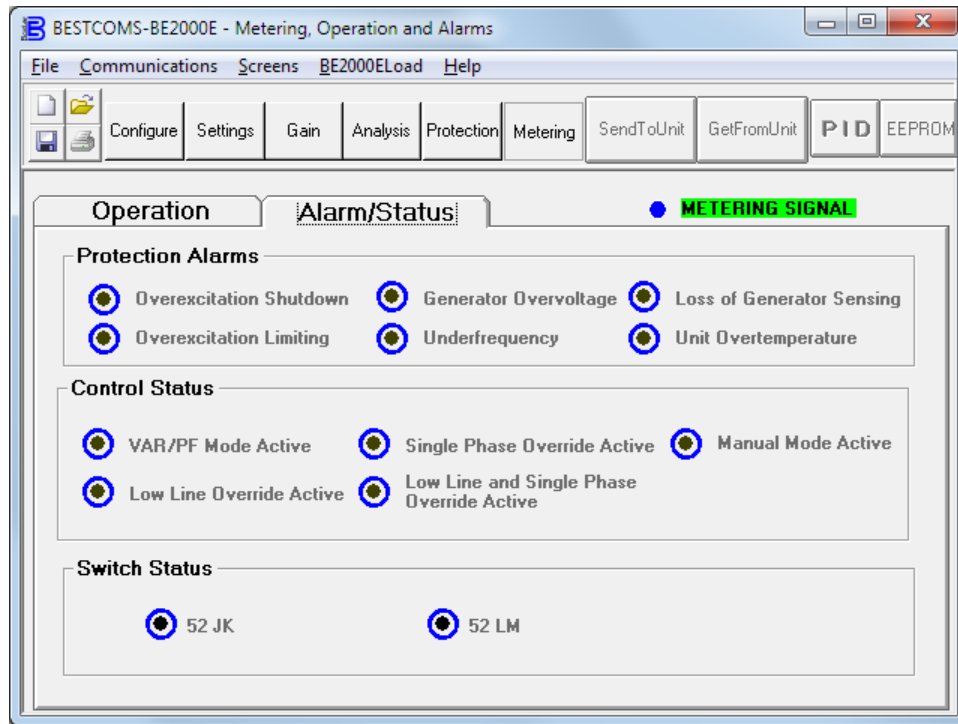

Figure 5-22. Metering, Operation and Alarms - Alarm/Status Tab

Protection Alarms. Protection Alarm indicators provide the status of BE2000E protection functions. Alarm indicators include Overexcitation Shutdown, Overexcitation Limiting, Underfrequency, Generator Overvoltage, Loss of Generator Sensing, and Unit Overtemperature. When a BE2000E protection function detects an alarm condition, the appropriate indicator changes from black to red.

Control Status. The VAR/PF Mode Active indicator changes from black to red when the BE2000E is operating in AVR mode and correction of power factor or vars is selected. The Low-Line Override Active indicator changes from black to red when low-line override is active. The Single-Phase Override Active indicator changes from black to red when single-phase override is active. The Low-Line and Single-Phase Override Active indicator changes from black to red when both the low-line and single-phase override functions are active. The Manual Mode Active indicator changes from black to red when the FCR control mode is active.

Switch Status. Switch Status indicators indicate when the BE2000E control inputs are open or closed. The 52JK switch open indicator changes from black to red when the user-supplied contacts at terminals 52J and 52K are closed. When this control input is open, selection of PF or VAR mode can be made on the Operation tab of the Metering, Operation, and Alarms screen. The 52LM switch closed indicator changes from black to red when the user-supplied contacts at terminals 52L and 52M are closed. When this control input is closed, parallel control and droop is inactive.

Metering Signal. The Metering Signal indicator of the *Alarm/Status* tab flashes to indicate when metering is active. When the *Metering* button is clicked or *Metering* on the menu bar is clicked followed by Disable Metering, the Metering Signal indicator stops flashing and the metering functions stop being updated.

PID Data

BESTCOMS-BE2000E enables generator stability to be set through the automatic calculation of PID parameters. PID stands for Proportional, Integral, Derivative. The word proportional means that the response of the BE2000E output is proportional or relative to the amount of change that is observed.

Integral means that the BE2000E output is proportional to the amount of time that a change is observed. Integral action eliminates offset. Derivative means that the BE2000E output is proportional to the required rate of excitation change. Derivative action avoids excitation overshoot.

BESTCOMS-BE2000E automatically calculates PID values after the user selects the generator frequency, generator time constant (T'do), and exciter time constant (Texc). With BESTCOMS-BE2000E software, the user may generate new PID numbers, add to a PID list file, and update the AVR gain settings.

The PID window (Figure 5-23) is accessed by clicking the *PID* button. The *PID* button can be clicked only when the Stability Range setting of the *Control Gain* screen is set at a value of 21. (A setting of 21 enables the entry of custom stability settings through the PID window.) Then, when a field of the *Control Gain* screen is changed or selected, the *PID* button changes from gray to yellow and the button can be clicked to view the PID window. After the PID numbers are modified, calculated, and updated, the PID window is closed by clicking the *Update Setting Screen* button. The modified PID values are then shown on the *Control Gain* screen.

Figure 5-23. PID Window

PID Calculation Based on Input Values

The available range for the exciter time constant depends on the value entered for the generator time constant. (The default value for the exciter time constant is the generator time constant divided by 6.) The generator time constant value selected must be in the range of 1.00 to 15.00 seconds and in 0.05 increments. When the generator time constant value is 1.00, the available exciter time constant range is 0.03 to 0.50 in 0.01 second increments. When the generator time constant value is 15.00, the available exciter time constant range is 0.30 to 3.00 in 0.01 second increments.

For example, when T'do is set at 2.0 seconds, Texc is 0.33. After specifying the input values, a set of PID parameters (output data) is generated automatically. If T'do is set at 5.00 seconds, then Texc is 0.83 seconds. The calculated KP is 155.47, KI is 138.72, KD is 48, and Kg is 1.

PID parameters can be directly removed from, added to, or modified in the PID List Data. PID parameters may also be saved into a file (pidlist.dat).

Adding to the PID List

Caution

Improper PID numbers will result in poor system performance or system damage.

PID parameters can be added to a list and recalled for operation and comparison. To add to the list, type a name for the generator (or other appropriate information) in the generator information box. Select the generator time constant. Observe the PID gain parameters in the Field Output Data fields. If these gain parameters are appropriate, click the *Add to PID List* button. Check for the new parameters by pulling down the PID List (click the *Down* arrow). The new gain and time constant parameters should be displayed.

Removing a PID List Record

PID parameters can also be removed from the list. To remove a list (record), pull down the PID List and select the record or list so that the gain and time constant parameters are displayed. Click the *Remove Record* button and the listed record is deleted.

Retrieving Existing Data from the PID List

To retrieve existing data, pull down the PID List and select the record or list so that the gain and time constant parameters are displayed and highlighted. Click the *Get from a List* button and the listed record input and output data displays in the boxes.

Settings Files

BESTCOMS-BE2000E enables you to print a list of BE2000E settings, save BE2000E settings to a file, and open a settings file and upload those settings to a BE2000E. a settings file may also be opened and edited within any text editing software.

Printing Settings Files

A printout of BE2000E settings can be useful for record keeping or comparison purposes. BE2000E settings are printed by clicking the print icon or clicking *File* on the menu bar and then clicking *Print*. When the print command is given, a print dialog box prompts you to select a printer. Once the printer is selected, a second dialog box (Figure 5-24) provides the opportunity to add a title and comments to the settings list. Each entry is limited to a maximum of 60 characters. After this information is entered, *OK* is clicked and the report is printed.

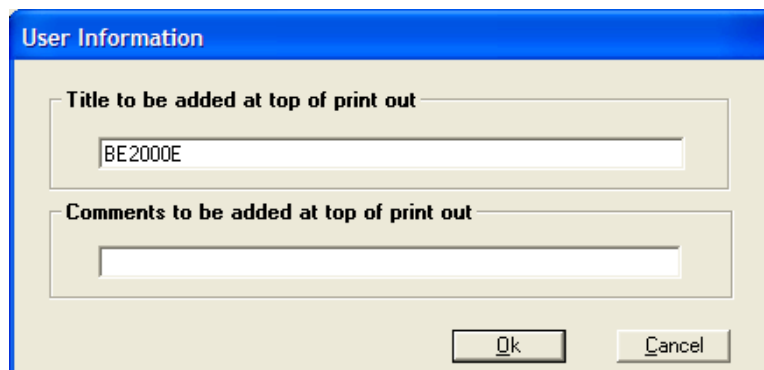

The image shows a dialog box titled "User Information" with a blue header. It contains two text input fields. The first field is labeled "Title to be added at top of print out" and contains the text "BE2000E". The second field is labeled "Comments to be added at top of print out" and is currently empty. At the bottom right of the dialog box, there are two buttons: "Ok" and "Cancel".

Figure 5-24. User Information Dialog Box for Settings List

Saving Settings Files

Saving BE2000E settings to a file for uploading to other BE2000E units saves setup time when configuring multiple units to the same configuration. A settings file can also be created in BESTCOMS-BE2000E without being connected to a BE2000E. The settings of the desired screens can be changed and these settings can then be saved to a file. Once a settings file is created, it can be edited using any text editing software, and then saved for uploading.

A settings file is created by clicking the save icon or by clicking *File* on the menu bar and then clicking *Save*. When the file command is given, a dialog box asks if you want to save the current settings into a BE2000E data file. Clicking *Yes* displays a *Save As* dialog box where the settings are assigned a file name and then saved. All BE2000E settings files are automatically given a *.BE2 extension by BESTCOMS-BE2000E.

Uploading Settings Files

A BE2000E settings file downloaded from a BE2000E or created within BESTCOMS-BE2000E can be uploaded to multiple BE2000E units. Only a BE2000E settings file with a .BE2 extension can be uploaded to a BE2000E unit. Before uploading a file, communication must be initiated with the BE2000E that is to receive the settings. Refer to the paragraphs under the headings *Starting the BESTCOMS-BE2000E Application*.

Caution

Before uploading a settings file, remove operating power from the BE2000E, disconnect the field wiring from terminals F+ and F-, and reapply operating power to the BE2000E.

The upload process is started by clicking the open icon or clicking *File* on the menu bar and then clicking *Open*. A dialog box is then displayed (Figure 5-25) reminding you that the BE2000E should be off-line before uploading settings. Clicking *Yes* loads the settings into BE2000E memory.

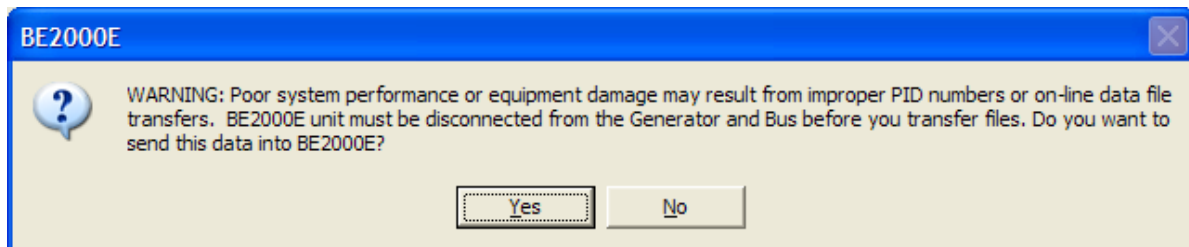

Figure 5-25. Settings Upload Dialog Box

Password Protection

Password protection guards against unauthorized changing or viewing of BE2000E settings. A single password protects all BE2000E settings. The BE2000E is delivered with a default password of *OEM*. Changing the password provides security against unauthorized changes to settings. Once changed, the password should be stored in a secure location. If the user-defined password is lost or forgotten, BESTCOMS-BE2000E must be reloaded to restore the default password.

Changing the Password

Note

A password change can be made only after communication between BESTCOMS-BE2000E and the BE2000E is established.

A new password can be programmed by performing the following steps:

1. Click *Communications* on the menu bar and click *Password Change* on the drop-down menu. The Change Password dialog box of Figure 5-26 appears.
2. Type the current password in the "Enter your access password" field of the Change Password dialog box and press the *Enter* key on your keyboard.
3. Another dialog box will appear with instructions for making the password change. Click the *OK* button and type a new password (8 alphanumeric characters, maximum) in the "Enter your new password" field.
4. Press the *Enter* or *Tab* key on your keyboard to advance the cursor into the field labeled "Re-enter your new password". Type the new password again to confirm the changed password and press the *Enter* key. When the *Enter* key is pressed, the new password is enabled and a dialog box appears to remind you to keep your password in a secure location.



Figure 5-26. Password Dialog Box

Updating Embedded Firmware

The BE2000E uses non-volatile flash memory for storing its embedded firmware (operating program) and can be reprogrammed by connecting the RS-232 port, located on the back of the device, to a Windows® compatible PC running the Embedded Program Loader software. It is not necessary to physically replace EPROM chips to update the program.

The process of updating the embedded firmware can be started by clicking **BE2000ELoad** on the menu bar and clicking **Uploading Embedded Software**. A warning window, Figure 5-27, will be displayed. The BE2000E should be disconnected from the generator and bus before continuing with this procedure and the current settings file should be backed up since uploading may replace some settings with defaults. Clicking **No** will cancel this procedure.

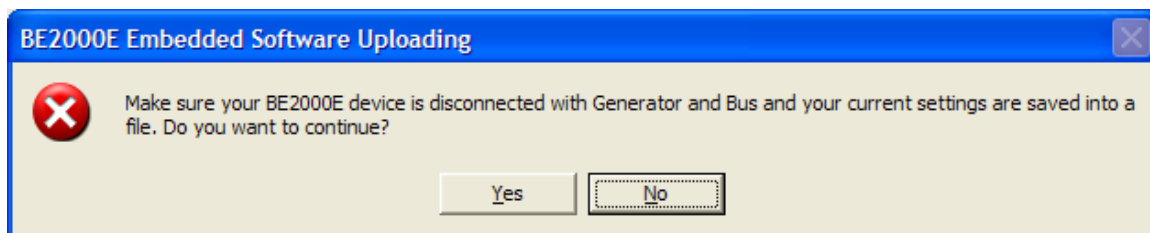

Figure 5-27. Embedded Software Uploading

Click **Yes** to proceed with software uploading. When Yes is clicked, the following screen (Figure 5-28) is shown to select the communication port. When Initialize is selected, PC Software reads, checks within ranges and saves all settings. The following progress bar (Figure 5-29) is shown while in process.

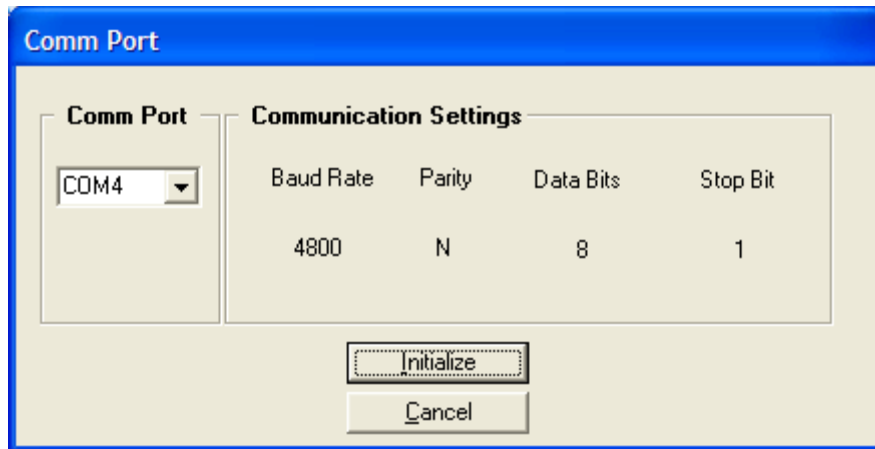

Figure 5-28. Communication Settings

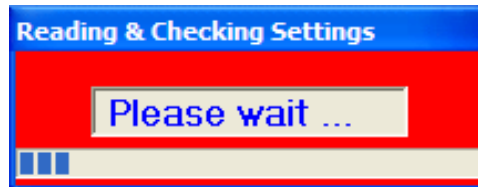

Figure 5-29. Reading & Checking Settings Progress Bar

The BE2000E Embedded Program Loader (Figure 5-30) will be displayed.

Clicking the **Get Device Information** button displays the current device's model number, style number, application program version, and serial number in the lower left hand corner of Figure 5-30.

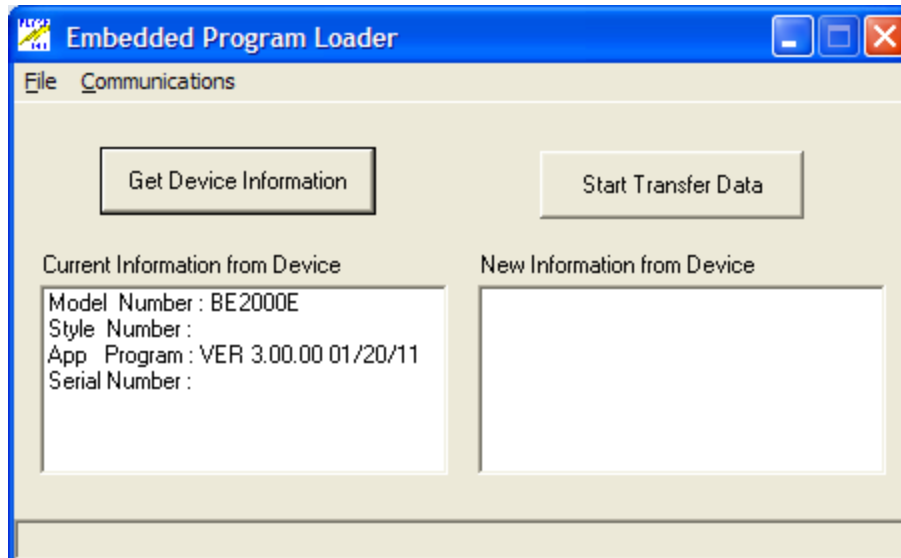

Figure 5-30. BE2000E Embedded Program Loader

Caution

If power is lost or communication is interrupted during transfer, the unit will not recover and will no longer be operational.

Clicking the **Start Transfer Data** button displays the *Settings File Saved?* window (Figure 5-31). Clicking **No** in the Settings File Saved window will return the user to the BE2000E Embedded Program Loader screen (Figure 5-30). Clicking **Yes** will display the Open Dialog box (Figure 5-32).

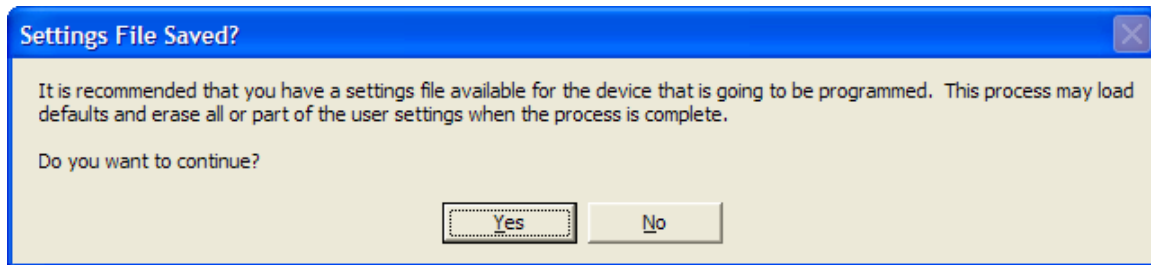

Figure 5-31. Settings File Saved Dialog Box

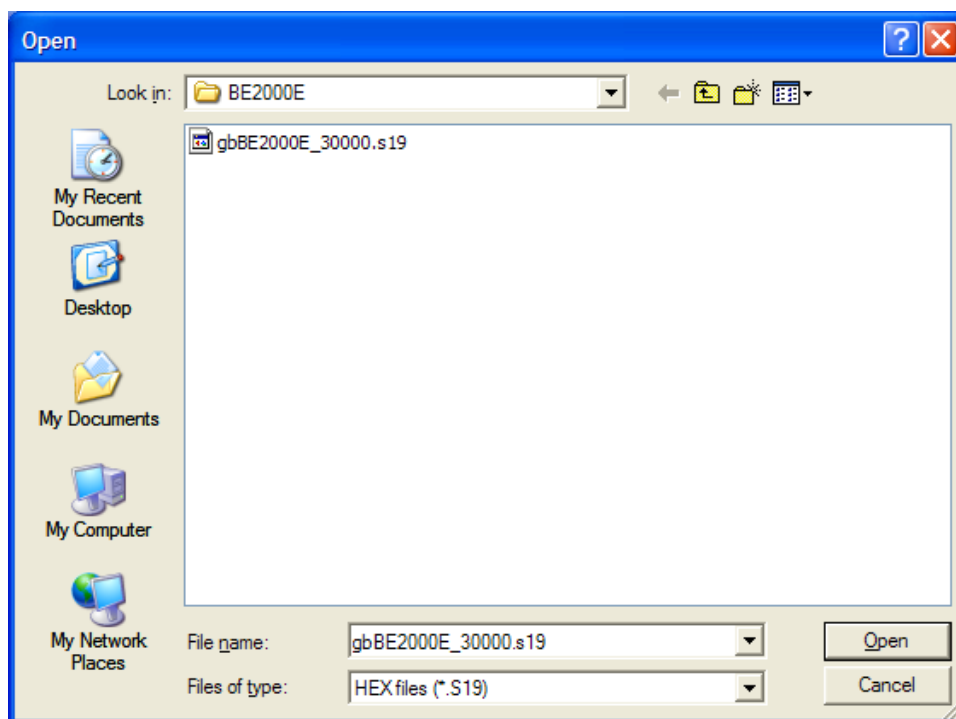

Figure 5-32. Open Dialog Box

Select the location of the embedded firmware update file, select the file, and click **Open**. The embedded firmware will begin transferring from the PC to the BE2000E. A progress bar, as displayed in Figure 5-33 marks the progress of the transfer.

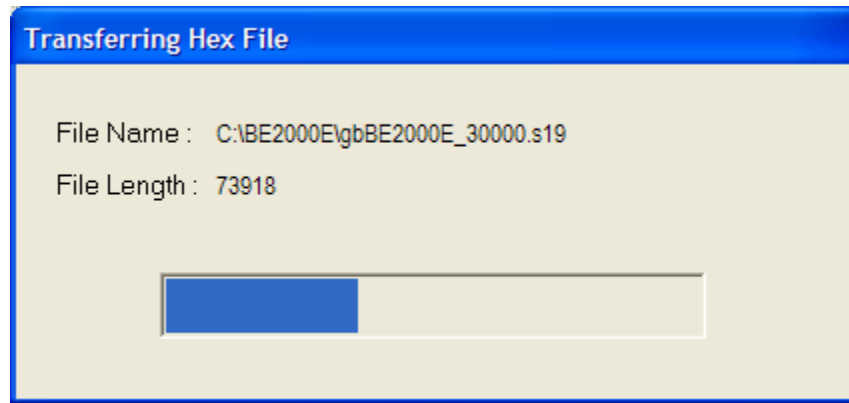

Figure 5-33. Transferring Hex File Dialog Box

The BE2000E unit will reboot automatically upon completion of the transfer. The new information from the device will be displayed in the lower right hand corner of the Embedded Program Loader dialog box. See Figure 5-30. Close the BE2000E Embedded Program Loader. PC software then loads the default settings. The saved settings will be loaded back into the unit (Figure 5-34) and checked again (Figure 5-35).

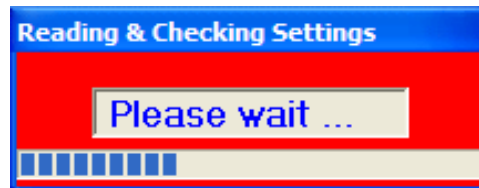

Figure 5-34. Reading & Checking Settings

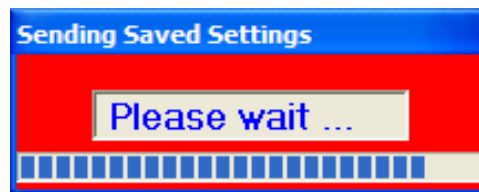

Figure 5-35. Sending Saved Settings

Terminating Communication

BE2000E communication is terminated by clicking on **C**ommunications on the menu bar, and clicking **C**lose Comm Port. You are asked if you want to save the settings to EEPROM. This question is asked even if no changes were made to the BE2000E settings. When you execute the Close command (with a Yes or No to save settings to EEPROM), communication with the BE2000E is terminated. If you choose to exit BESTCOMS-BE2000E (by clicking **F**ile on the menu bar and then **E**xit) without first closing communication, you are still given the opportunity to save the settings to EEPROM.



6 • Maintenance and Troubleshooting

Preventative Maintenance

The only preventive maintenance required on the BE2000E is to periodically check that the connections between the BE2000E and the system are clean and tight. BE2000E units are manufactured using state-of-the-art, surface-mount technology. As such, Basler Electric recommends that no repair procedures be attempted by anyone other than Basler Electric personnel.

Troubleshooting

If you do not get the results that you expect from the BE2000E, first check the programmable settings for the appropriate function. Use the following troubleshooting procedures when difficulties are encountered in the operation of your excitation system.

Generator Voltage Does Not Build

- Step 1. Verify that all wiring is properly connected. Refer to Figures 9 through 13.
If wiring is improperly connected or loose, reconnect wiring properly.
If wiring connections are correct, proceed to Step 2.
- Step 2. Verify that the generator is spinning at rated speed.
If the generator is not up to rated speed, increase generator speed to the rated value.
If the generator is spinning at rated speed, proceed to Step 3.
- Step 3. Check for correct input power to the BE2000E. Refer to the *General Information* chapter for input power requirements.
If voltage is not present, refer to the generator manual for repair procedures.
If voltage is present, proceed to Step 4.
- Step 4. Verify that the fuse is not open.
Replace the open fuse (F1) with Basler Electric P/N 20372.
If no fuse is open, proceed to Step 5.
- Step 5. Verify that the front panel OVEREXCITATION SHUTDOWN indicator is not lit.
If the front panel OVEREXCITATION SHUTDOWN indicator (field voltage) is lit, check the generator and/or load conditions. Interrupt input power or shut down the generator for a minimum of one minute.
If the front panel OVEREXCITATION SHUTDOWN indicator is not lit, proceed to Step 6.
- Step 6. Verify that the front panel OVEREXCITATION LIMITING indicator is not lit.
If the front panel OVEREXCITATION LIMITING indicator is lit, check the generator and load conditions. Also check the field current limit setpoint for the correct level. Interrupt input power or shut down the generator for a minimum of 1 minute.
If the front panel OVEREXCITATION LIMITING indicator is not lit, proceed to Step 7.
- Step 7. Verify that the BE2000E soft start settings are correct. Too long of a soft start setting may give the appearance of no buildup.
If the soft start settings are incorrect, adjust the settings.
If the soft start settings have no effect, proceed to Step 8.

Step 8. Replace the BE2000E unit.

If replacing the BE2000E unit does not correct the malfunction, then the generator is defective. Consult with the generator manufacturer.

Low Generator Output Voltage

Step 1. Verify that the voltage adjustment is not set too low.

If the voltage adjustment is too low, adjust it to the correct setpoint.

If the voltage adjustment is correct, proceed to Step 2.

Step 2. Verify that the underfrequency knee setpoint is not greater than the generator frequency.

If the underfrequency setpoint is too high, adjust the setpoint below the rated generator frequency.

If the underfrequency setpoint is correct, proceed to Step 3.

Step 3. Verify that the generator is spinning at rated speed.

If the generator is not up to rated speed, increase the generator speed to the rated level.

If the generator is spinning at rated speed, proceed to Step 4.

Step 4. Check for correct input power to the BE2000E. Refer to the *General Information* chapter for input power requirements.

If the BE2000E input voltage is low, refer to the PMG manual for PMG.

If the voltage is at the required level, proceed to Step 5.

Step 5. Verify that the sensing potential transformer (if used) has the correct turns ratio and is operating correctly.

If the turns ratio of the sensing potential transformer is incorrect, replace the sensing potential transformer.

If the sensing potential transformer is operating correctly, proceed to Step 6.

Step 6. Verify that the front panel OVEREXCITATION LIMITING indicator is not lit.

If the front panel OVEREXCITATION LIMITING indicator is lit, check the generator and/or load conditions. Also check the field-current limit setpoint for the correct level. Interrupt input power or shut down the generator for a minimum of one minute.

If the front panel OVEREXCITATION LIMITING indicator is not lit, proceed to Step 7.

Step 7. Low generator output voltage may occur when operating in droop mode with an inductive load.

If the low voltage condition is not caused by the droop function, proceed to Step 8.

Step 8. Replace the BE2000E unit.

High Generator Output Voltage

Step 1. Verify that the voltage adjustment is not set too high.

If the voltage adjustment is too high, adjust it to the correct setpoint.

If the voltage adjustment is correct, proceed to Step 2.

Step 2. Verify that the sensing potential transformer (if used) has the correct turns ratio.

If the turns ratio of the sensing potential transformer is incorrect, replace the sensing potential transformer with the correct one.

If the sensing potential transformer is correct, proceed to Step 3.

Step 3. High generator output voltage may occur when operating in droop mode with a capacitive load.

If the high voltage condition is not caused by the droop function, proceed to Step 4.

Step 4. Replace the BE2000E unit.

Poor Voltage Regulation

- Step 1. Verify that the case of the BE2000E is properly grounded.
If the BE2000E is not properly grounded, connect a dedicated ground wire to the quarter-inch fast-on connector labeled GND on the rear of the BE2000E case.
If the BE2000E is properly grounded, proceed to Step 2.
- Step 2. Check for grounded field leads.
If the field leads are grounded, isolate them from ground.
If the field leads are not grounded, proceed to Step 3.
- Step 3. Check for grounded PMG leads.
If the PMG leads are grounded, isolate them from ground.
If the PMG leads are not grounded, proceed to Step 4.
- Step 4. Verify that the generator frequency is not dropping below the BE2000E underfrequency setpoint when load is applied to the generator.
If the generator frequency is dropping below the underfrequency setpoint, reduce the setpoint if possible. Also check the prime mover and generator for proper sizing in relation to the applied load.
If poor regulation is not related to BE2000E underfrequency operation, proceed to Step 5.
- Step 5. Verify that regulation is not being affected by normal droop operation.
If droop operation is not affecting regulation, proceed to Step 6.
- Step 6. Replace the BE2000E unit.

Generator Output Unstable (Hunting)

- Step 1. Verify that the governor for the prime mover is operating properly.
If the governor is not operating properly, troubleshoot using the manufacturer's suggested procedures.
If the governor is operating properly, proceed to Step 2.
- Step 2. Verify that the sensing and input power leads are connected securely.
If the sensing or input power leads are not connected securely, tighten the connections.
If the sensing or input power lead connections are secure, proceed to Step 3.
- Step 3. Verify that the BE2000E Stability Range is set to the proper range.
If the Stability Range setting is incorrect, reset the Stability Range.
If the Stability Range setting is correct, proceed to Step 4.
- Step 4. Verify that the Stability Level is properly set.
If the Stability Level is not properly set, reset the Stability Level.

OVEREXCITATION SHUTDOWN Indicator Is Annunciating

- Step 1. Verify that the field overvoltage setpoint is adjusted properly.
If not properly adjusted, readjust the field overvoltage setpoint.
If properly adjusted, proceed to Step 2.
- Step 2. Check for generator overloading.
If the generator is operating with a larger than rated load, shed load.
If the generator is operating with a rated or less than rated load, proceed to Step 3.

- Step 3. Replace the BE2000E.
If replacing the BE2000E does not correct the malfunction, proceed to Step 4.
- Step 4. Refer to the generator manual. Generator is defective.

LOSS OF GENERATOR SENSING Indicator Is Annunciating

- Step 1. Verify that the voltage sensing leads are properly connected.
If the sensing leads are not properly connected, correct the connections.
If the sensing lead connections are correct, proceed to Step 2.
- Step 2. For single-phase sensing, verify that E2 and E3 are connected.
If E2 and E3 are not connected, connect them both to phase C sensing voltage.
If E2 and E3 are properly connected, proceed to Step 3.
- Step 3. Verify that the sensing potential transformer (if used) has the correct turns ratio and is functioning properly.
If the sensing potential transformer has the wrong turns ratio or is malfunctioning, replace it.
If the sensing potential transformer is correct and functioning properly, proceed to Step 4.
- Step 4. Verify that the generator output voltage is present on all phases.
If the generator is missing a phase, refer to the generator manual. Generator is defective.
If generator output voltage is balanced on all phases, proceed to Step 5.
- Step 5. Replace the BE2000E.

OVEREXCITATION LIMITING Indicator Is Annunciating

- Step 1. Check for generator overloading.
If the generator is operating with a larger than rated load, shed load.
If the generator is operating with a rated or less than rated load, proceed to Step 2.
- Step 2. Verify that the BE2000E output (field) current limit is not set too low.
If the output current limit setpoint is too low, adjust for the proper setting.
If the output current limit is set properly, proceed to Step 3.
- Step 3. Verify that the generator exciter field is not shorted.
If the generator exciter field is shorted, replace the generator.
If the generator exciter field is not shorted, proceed to Step 4.
- Step 4. Replace the BE2000E.
If replacing the BE2000E does not correct the malfunction, proceed to Step 5.
- Step 5. Refer to the generator manual. Generator is defective.

UNDERFREQUENCY ACTIVE Indicator Is Annunciating

- Step 1. Verify that the generator is operating at rated speed.
If the generator is not operating at rated speed, adjust the generator speed.
If the generator is operating at the rated speed, proceed to Step 2.
- Step 2. Verify that the underfrequency setpoint is correct.
If the underfrequency setpoint is incorrect, adjust it to the correct value.

No Droop

- Step 1. Verify that the BE2000E 52L/M contact input is open.
If the 52L/M contact input is not open, it must be opened to enable the droop function.
If the 52L/M contact input is open, proceed to Step 2.
- Step 2. Verify that the BE2000E 52J/K contact input is closed or the Var/PF function is disabled via the Windows® software. Var/PF operation must be disabled for droop operation. If Var/PF operation is disabled, proceed to Step 3.
- Step 3. Verify that the BE2000E droop setting is not adjusted to 0% droop.
If the droop setting is adjusted to 0% droop, increase the setpoint above 0%.

If the droop setting is adjusted to above 0%, proceed to Step 4.
- Step 4. Check for an open in the circuit connected to BE2000E CT1 and CT2.
If there is an open circuit, repair as necessary.
If there is no open circuit, proceed to Step 5.
- Step 5. Verify that all connections are correct according to Figures 4-6 and 4-7.
If connections are incorrect, correct the problem.
If connections are correct, proceed to Step 6.
- Step 6. Verify that the load being applied to the generator for droop testing is not purely resistive.
If only a resistive load is being applied to the generator, apply an inductive load and retest.
If the load being applied to the generator is inductive, proceed to Step 7.
- Step 7. Verify that your BE2000E is compatible with the current sensing transformer (5 A secondary) being used. For example, a current sensing transformer with a 1 ampere output rating would produce very little droop since your BE2000E has a 5 ampere current transformer input.
If the current transformer input is incorrect, replace the current sensing transformer for compatibility.
If the current transformer input is correct, proceed to Step 8.
- Step 8. If the above steps fail to correct the malfunction, replace the BE2000E unit.



7 • Specifications

BE2000E electrical and physical specifications are listed in the following paragraphs. The adjustment increments shown apply to the PC software. Adjustment increments for the Front Panel Controls are listed in the *Human-Machine Interface* chapter.

Operating Power

Single-Phase.....	180 to 240 Vac
Frequency Range.....	120 to 300 Hz
Burden.....	330 VA
Terminals.....	3, 4

Generator Voltage Sensing

Type	1-phase/3-phase, 4 ranges, 50/60 Hz
Terminals.....	E1, E2, E3
Fuse (F1).....	Basler Electric P/N 20372
Burden.....	<1 VA per phase
Range 1.....	120 Vac (100 to 140 Vac)
Range 2.....	240 Vac (200 to 280 Vac)
Range 3.....	480 Vac (400 to 560 Vac)
Range 4.....	600 Vac

Generator Current Sensing

Type	1-phase (BØ), 50/60 Hz
Rating.....	5 Aac maximum continuous
Burden.....	<0.1 VA
Terminals.....	CT1, CT2

Contact Input Circuits

Type	Dry Contact
Interrogation Voltage.....	13 Vdc

Terminals

Unit/Parallel Control	52L, 52M
Raise	6U, 7
Lower.....	6D, 7
var/PF Enable	52J, 52K

Common Alarm Output

Type	Form A
Rated Load.....	7 Aac/7 Adc continuous
Make.....	30 Aac/30 Adc, carry for 0.2 seconds
Break	7 Aac/0.1 Adc
Operating Voltage	240 Vac/250 Vdc maximum
Terminals.....	AL1, AL2

Field Output

Continuous Rating.....	75 Vdc, 3.0 Adc
------------------------	-----------------

10 Second Forcing Rating

200 Vac Power Input:.....	150 Vdc, 7.5 Adc
Field Resistance:.....	18 Ω minimum
Terminals:.....	F+, F-

AVR Operating Mode

Adjustment Range..... See generator voltage sensing
 Voltage Regulation..... $\pm 0.25\%$ over load range at rated PF and constant generator frequency
 Temperature Drift..... $\pm 0.5\%$ for a 40°C change
 Response Time..... ≤ 1 cycle

Underfrequency (V/Hz)

Characteristic Slope from 1 to 3 PU is adjustable in 0.01 increments
 Range..... 40 to 65 Hz
 Increment 0.01 Hz

FCR (Manual) Operating Mode

Adjustment Range..... 0 to 3 Adc
 Increment 0.01 A

Var Operating Mode

Adjustment Range..... 100% to -100%
 Increment 0.1%

PF Operating Mode

Adjustment Range..... 0.6 lead to 0.6 lag
 Increment 0.001

Parallel Compensation

Modes..... Reactive Droop and Reactive Differential (cross-current)*

Droop

Adjustment Range..... 0 to 10%
 Increment 0.01%

* Burden can exceed 1 VA if external resistors are added to the CT circuit.

Communication Port

Interface Full Duplex RS-232
 Connection DB-9 connector on rear panel
 Baud 4800
 Data Bits 8
 Parity None
 Stop Bit..... 1

Field Overvoltage Protection

Pickup..... 0 to 250 Vdc
 Time Delay 15 seconds (fixed)

Field Overcurrent ProtectionPickup

Adjustment Range..... 0 to 7.5 Adc
 Increment 0.001 Adc

Time Delay

Adjustment Range..... 0 to 10 seconds
 Increment 1 second

Generator Overvoltage Protection

Pickup

Range..... 105 to 120% of setpoint
 Increment 1.0%

Time Delay

Fixed Setting 0.75 seconds

Soft-Start Function

Time Adjust Range..... 1 to 120 seconds
 Increment 1 second

Analog (Auxiliary) Input

Voltage Range -3 Vdc to +3 Vdc
 Setpoint Range -30% to +30% shift
 Burden..... 1 k Ω
 Terminals..... A, B

Metering

Accuracy of all metering values assumes 25°C, 50/60 Hz and less than 20% THD.

Generator Voltage

Range..... 10 V to 79 kV
 Accuracy..... 0.5%

Generator Current

Range..... 0.1 to 5,000 A (5 A CTs)
 Accuracy..... 0.5%

Frequency

Range..... 40 to 65 Hz
 Accuracy..... 0.2 Hz

Field Voltage

Range..... 0 to 200 Vdc
 Accuracy..... 5.0%

Field Current

Range..... 0 to 8.0 Adc
 Accuracy..... 0.5%

Power (Apparent, Real and Reactive)

Range..... 0 to 99 MVA, MW and Mvar
 Accuracy..... 3.0%

Power Factor

Range..... -1.0 to -0.6, +0.6 to +1.0
 Accuracy..... 0.02

Phase Angle

Range..... 0 to 360°
 Accuracy..... 2°

PRODUCT:		BE2000E				
零件名称 Part Name	有害物质 Hazardous Substances					
	铅 Lead (Pb)	汞 Mercury (Hg)	镉 Cadmium (Cd)	六价铬 Hexavalent Chromium (Cr ⁶⁺)	多溴联苯 Polybrominated Biphenyls (PBB)	多溴二苯醚 Polybrominated Diphenyl Ethers (PBDE)
金属零件 Metal parts	O	O	O	O	O	O
聚合物 Polymers	O	O	O	O	O	O
电子产品 Electronics	X	O	O	O	O	O
电缆和互连配件 Cables & interconnect accessories	X	O	O	O	O	O
绝缘材料 Insulation material	O	O	O	O	O	O

本表格依据 SJ/T11364 的规定编制。

O: 表示该有害物质在该部件所有均质材料中的含量均在 GB/T 26572 规定的限量要求以下。

X: 表示该有害物质至少在该部件的某一均质材料中的含量超出 GB/T 26572 规定的限量要求。

This form was prepared according to the provisions of standard SJ/T11364.

O: Indicates that the hazardous substance content in all homogenous materials of this part is below the limit specified in standard GB/T 26252.

X: Indicates that the hazardous substance content in at least one of the homogenous materials of this part exceeds the limit specified in standard GB/T 26572.

Physical

Weight: 1.52 lb. (690 g)





Highland, Illinois USA
Tel: +1 618.654.2341
Fax: +1 618.654.2351
email: info@basler.com

Suzhou, P.R. China
Tel: +86 512.8227.2888
Fax: +86 512.8227.2887
email: chinainfo@basler.com