

**POWERTECH 2.9 L
OEM Diesel
Engines**

**OPERATION AND
SERVICE MANUAL**



**Deere Power Systems Group
OMRG27897 Issue (13FEB01)**

LITHO IN U.S.A.
ENGLISH



DEERE
POWER

Introduction

FOREWORD

THIS MANUAL CONTAINS INFORMATION to operate and service the following engines:

Saran-built (France) Emission Non-Certified Engines:

- CD3029DF120
- CD3029DF121
- CD3029DF122
- CD3029DF123
- CD3029DF124
- CD3029DF160
- CD3029DF161
- CD3029DF162
- CD3029DF163
- CD3029DF164
- CD3029DF165
- CD3029TF120
- CD3029TF121
- CD3029TF123
- CD3029TF160
- CD3029TF161
- CD3029TF162
- CD3029TF163

Saran-built (France) Emission Certified Engines:

- CD3029DF150
- CD3029DF151
- CD3029DF152
- CD3029DF180
- CD3029TF150
- CD3029TF152
- CD3029TF180

Torreón-built (Mexico) Emission Non-Certified Engines:

- PE3029DF120
- PE3029TF120

Torreón-built (Mexico) Emission Certified Engines:

- PE3029DF150
- PE3029TF150

IMPORTANT: This manual replaces two Operation and Maintenance Manuals, OMRG27897 (30JAN98) and OMRG24311 (30AUG96) (Cancelled).

READ THIS MANUAL carefully to learn how to operate and service your machine correctly. Failure to do so could result in personal injury or equipment damage.

THIS MANUAL SHOULD BE CONSIDERED a permanent part of your machine and should remain with the machine when you sell it.

MEASUREMENTS IN THIS MANUAL are given in both metric and customary U.S. unit equivalents. Use only correct replacement parts and fasteners. Metric and inch fasteners may require a specific metric or inch wrench.

WRITE ENGINE SERIAL NUMBERS and option codes in the spaces indicated in the Record Keeping Section. *Accurately record all the numbers. Your dealer also needs these numbers when you order parts. File the identification numbers in a secure place off the engine.*

SETTING FUEL DELIVERY beyond published factory specifications or otherwise overpowering will result in loss of warranty protection for this engine.

CERTAIN ENGINE ACCESSORIES such as radiator, air cleaner, and instruments are optional equipment on John Deere OEM Engines. These accessories may be provided by the equipment manufacturer instead of John Deere. This operator's manual applies only to the engine and those options available through the John Deere distribution network.

CALIFORNIA PROPOSITION 65 WARNING
Diesel engine exhaust and some of its constituents are known to the State of California to cause cancer, birth defects and other reproductive harm.

ENGINE OWNER

John Deere Engine Owner:

Don't wait until you need warranty or other service to meet your local John Deere Engine Distributor or Service Dealer.

Learn who he is and where he is. At your first convenience, go meet him. He'll want to get to know you and to learn what your needs might be.

Aux Utilisateurs De Moteurs John Deere:

N'attendez pas d'être obligé d'avoir recours a votre concessionnaire John Deere ou point de service le plus proche pour vous adresser a lui.

Renseignez-vous des que possible pour l'identifier et le localiser. A la premiere occasion, prenez contact avec lui et faites-vous connaître. Il sera lui aussi heureux de faire votre connaissance et de vous proposer ses services le moment venu.

An Den Besitzer Des John Deere Motors:

Warten Sie nicht auf einen evt. Reparaturfall um den nächstgelegenen John Deere Händler kennen zu lernen.

Machen Sie sich bei ihm bekannt und nutzen Sie sein "Service Angebot".

Proprietario Del Motore John Deere:

Non aspetti fino a quando ha bisogno della garanzia o di un altro tipo di assistenza per incontrarsi con il Suo Concessionario che fornisce l'assistenza tecnica.

Impari a conoscere chi è e dove si trova. Alla Sua prima occasione cerchi d'incontrarlo. Egli desidera farsi conoscere e conoscere le Sue necessità.

Propietario De Equipo John Deere:

No espere hasta necesitar servicio de garantía o de otro tipo para conocer a su Distribuidor de Motores John Deere o al Concesionario de Servicio.

Entérese de quién es, y dónde está situado. Cuando tenga un momento, vaya a visitarlo. A él le gustará conocerlo, y saber cuáles podrían ser sus necesidades.

John Deere MotorÄgare:

Vänta inte med att besöka Din John Deere återförsäljare till dess att Du behöver service eller garanti reparation.

Bekanta Dig med var han är och vem han är. Tag första tillfälle att besöka honom. Han vill också träffa Dig för att få veta vad Du behöver och hur han kan hjälpa Dig.

IDENTIFICATION VIEWS

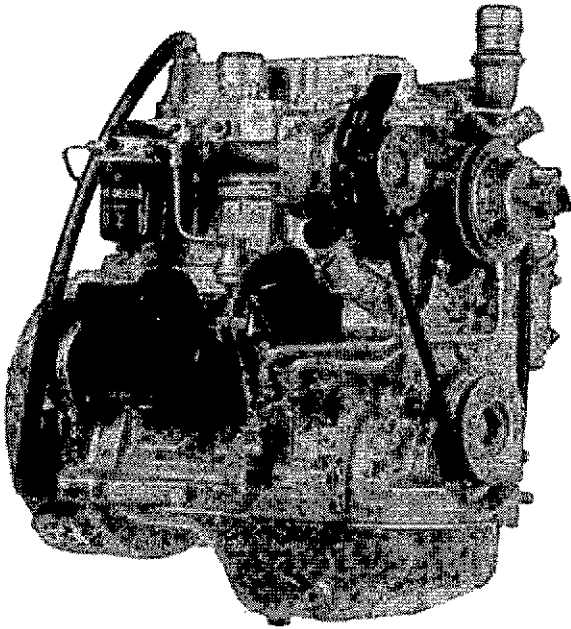

3029D Right Front View

RG9173 -UN-29NOV00

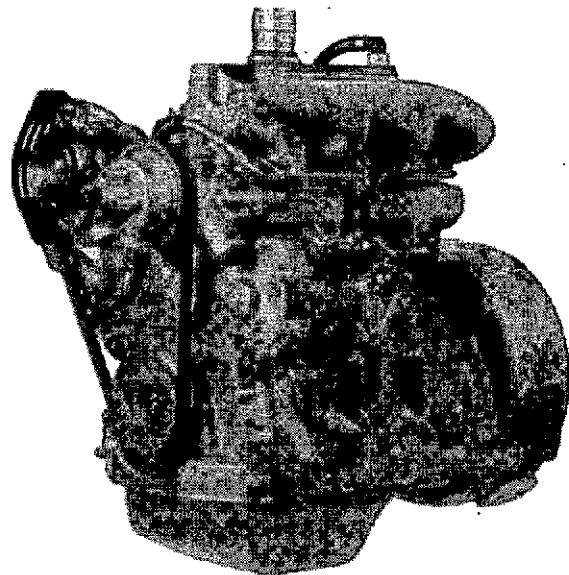

3029D Left Front View

RG9172 -UN-29NOV00

RG.RG34710,4501 -19-30JAN98-1/2

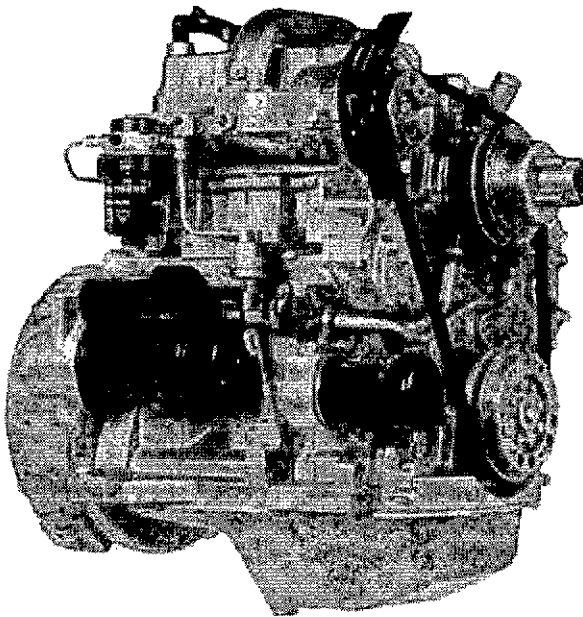

3029T Right Front View

RG9175 -UN-29NOV00

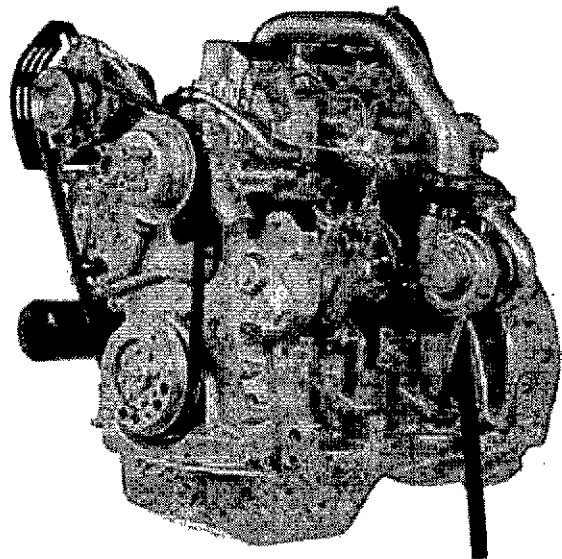

3029T Left Front View

RG9174 -UN-29NOV00

RG.RG34710,4501 -19-30JAN98-2/2

Contents

	Page		Page
Record Keeping			
Engine Serial Number Plate	01-1	Idling Engine	15-17
Record Engine Serial Number	01-1	Stopping the Engine	15-18
Engine Option Codes	01-2	Using a Booster Battery or Charger	15-20
Record Fuel Injection Pump Model Number	01-4	Lubrication and Maintenance	
Safety			
	05-1	Observe Service Intervals	20-1
Fuels, Lubricants, and Coolant			
Diesel Fuel	10-1	Use Correct Fuels, Lubricants, and Coolant	20-2
Lubricity of Diesel Fuel	10-1	Lubrication and Maintenance Service	
Diesel Fuel Storage	10-2	Interval - Prime Power Engines	20-3
DIESELSCAN Fuel Analysis	10-2	Lubrication and Maintenance Service	
Minimizing the Effect of Cold Weather on		Interval - Standby Power	20-5
Diesel Engines	10-3	Lubrication & Maintenance/Daily	
Diesel Engine Break-In Oil	10-4	Daily Prestarting Checks	25-1
Diesel Engine Oil	10-5	Lubrication and Maintenance/250 Hour	
Extended Diesel Engine Oil Service Interval	10-6	Servicing Fire Extinguisher	30-1
Mixing of Lubricants	10-6	Lubricating PTO Clutch Shaft Bearings	30-1
OILSCAN and COOLSCAN	10-7	Servicing Battery	30-2
Alternative and Synthetic Lubricants	10-7	Handling Batteries Safely	30-3
Lubricant Storage	10-8	Changing Engine Oil and Replacing Oil Filter	30-4
Grease	10-8	Checking Fan and Alternator V-Belt Tension	30-7
Diesel Engine Coolant	10-9	Checking PTO Clutch Adjustment	30-9
Diesel Engine Coolants, Supplemental		Checking Engine Mounts (Generator Sets)	30-10
Additive Information	10-10	Lubrication & Maintenance/400 Hour	
Testing Diesel Engine Coolant	10-11	Adjusting Engine Valve Clearance (New or	
Replenishing Supplemental Coolant		Rebuilt Engines)	35-1
Additives Between Coolant Changes	10-12	Lubrication & Maintenance/600 Hour/12 Month	
Operating in Warm Temperature Climates	10-13	Lubricating PTO Clutch Internal Levers and	
Disposing of Coolant	10-13	Linkage	40-1
Engine Operating Guidelines			
Instrument (Gauge) Panels	15-1	Cleaning Crankcase Vent Tube	40-1
Normal Engine Operation	15-7	Checking Air Intake System	40-2
Break-In Service	15-8	Replacing Fuel Filter Element	40-3
Auxiliary Gear Drive Limitations	15-12	Checking Cooling System	40-5
Generator Sets (Standby) Applications	15-12	Testing Diesel Engine Coolant	40-6
Starting the Engine	15-12	Replenishing Supplemental Coolant	
Cold Weather Operation	15-15	Additives (SCAs) Between Coolant	
Warming Engine	15-16	Changes	40-7
Changing Engine Speed-Standard		Pressurue Testing Cooling System	40-9
(Mechanical) Governor	15-17	Continued on next page	

All information, illustrations and specifications in this manual are based on the latest information available at the time of publication. The right is reserved to make changes at any time without notice.

COPYRIGHT © 2001
DEERE & COMPANY
Moline, Illinois
All rights reserved
A John Deere ILLUSTRATION® Manual
Previous Editions
Copyright © 1998

Contents

Page	Page
Lubrication & Maintenance/1200 Hour/24 Month	
Checking and Adjusting Engine Valve	Service, 600 Hour/12 Month 70-3
Clearance 45-1	Service, 1200 Hour/24 Month 70-4
Adjusting Variable Speed on Generator Set	Service as Required 70-5
Engines 45-4	
Flushing and Refilling Cooling System 45-5	Emission System Warranty
Testing Thermostat Opening Temperature 45-8	Emissions Control System Certification Label . . . 75-1
	U.S. Emissions Control Warranty Statement . . . 75-2
Service As Required	
Additional Service Information 50-1	
Do Not Modify Fuel System 50-1	
Adding Coolant 50-2	
Bleeding the Fuel System 50-3	
Replacing Air Cleaner Filter Elements 50-5	
Inspecting Primary Filter Element 50-7	
Cleaning Primary Filter Element 50-7	
Element Storage 50-8	
Replace Fan and Alternator Belts 50-8	
Power Take-Off (PTO) Clutch 50-9	
Checking Fuses 50-9	
Troubleshooting	
General Troubleshooting Information 55-1	
North American Wiring Diagram 55-2	
Engine Troubleshooting 55-4	
Electrical Troubleshooting 55-12	
Lubrication Troubleshooting 55-14	
Cooling System Troubleshooting 55-16	
Air Intake Troubleshooting 55-18	
Storage	
Engine Storage Guidelines 60-1	
Use AR41785 Engine Storage Kit 60-1	
Preparing Engine for Long Term Storage 60-2	
Removing Engine from Long Term Storage 60-3	
Specifications	
General OEM Engine Specifications 65-1	
Fuel Injection Pump	
Specifications-Emission Certified Engines 65-2	
Fuel Injection Pump	
Specifications-Emission Non-Certified	
Engines 65-3	
Engine Crankcase Oil Fill Quantities 65-5	
Unified Inch Bolt and Cap Screw Torque	
Values 65-8	
Metric Bolt and Cap Screw Torque Values 65-9	
Lubrication and Maintenance Records	
Using Lubrication and Maintenance Records . . . 70-1	
Daily (Prestarting) Service 70-1	
Service, 50 Hour/Every 2 Weeks 70-2	
Service, 400 Hours 70-3	

Record Keeping

ENGINE SERIAL NUMBER PLATE

Each engine has a 13-digit John Deere engine serial number. The first two digits identify the factory that produced the engine:

- "CD" indicates the engine was built in Saran, France
- "PE" indicates the engine was built in Torreon, Mexico

Your engine's serial number plate (A) is located on the right-hand side of cylinder block near the starter motor.

A—Serial Number Plate

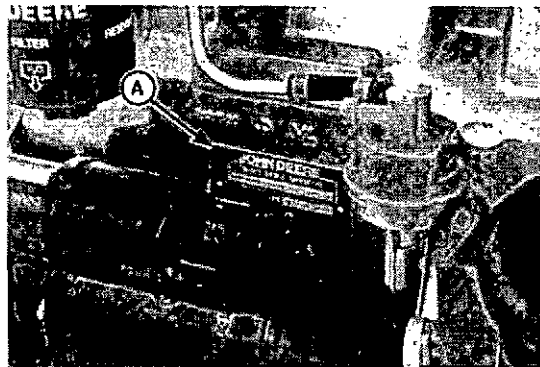

Engine Serial Number Plate Location

RG11522 -JUN-01DEC00

RG.RG34710,5002 -19-30JAN98-1/1

RECORD ENGINE SERIAL NUMBER

Record all of the numbers and letters found on your engine serial number plate in the spaces provided below.

This information is very important for repair parts or warranty information.

Engine Serial Number (A)

Engine Application Data (B)

Coefficient of Absorption Value (For Smoke Emissions) (C)
(Saran-Built Engines Only)

NOTE: Emission-certified engines have application data (B) ending in "150s" or "180s", while emission non-certified engines have application data (B) ending in "120s" or "160s".

A—Serial Number
B—Application Data
C—Coefficient of Absorption Value

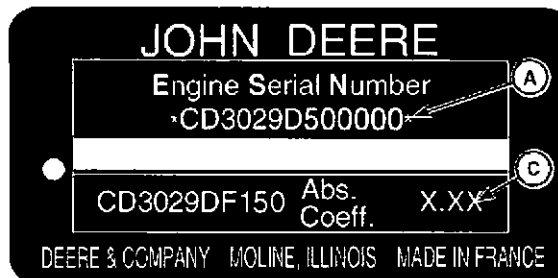

Saran Serial Number Plate

RG11523 -JUN-01DEC00

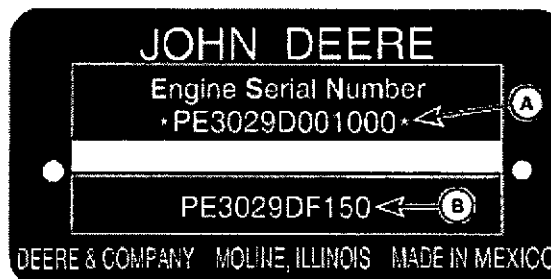

Torreon Serial Number Plate

RG11524 -JUN-01DEC00

RG.RG34710,5003 -19-30JAN98-1/1

ENGINE OPTION CODES

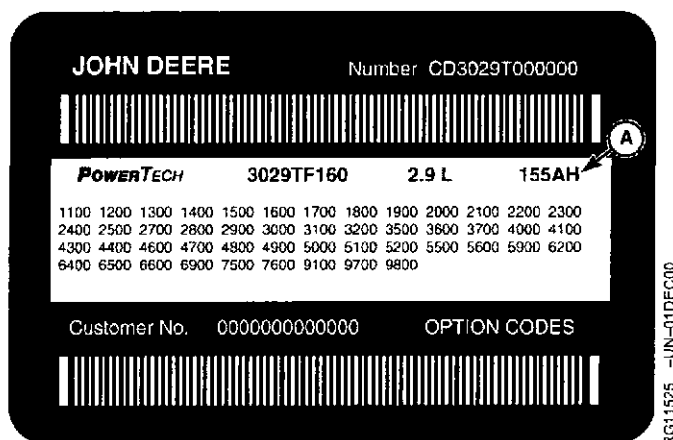

Option Code Label

A—Base Code

OEM engines have an engine option code label affixed to the rocker arm cover. These codes indicate which of the engine options were installed on your engine at the factory. When in need of parts or service, furnish your authorized servicing dealer or engine distributor with these numbers.

The engine option code label includes an engine base code (A). This base code must also be recorded along with the option codes. At times it will be necessary to furnish this base code to differentiate two identical option codes for the same engine model.

The first two digits of each code identify a specific group, such as alternators. The last two digits of each code identify one specific option provided on your engine, such as a 12-volt, 55-amp alternator.

If an engine is ordered without a particular component, the last two digits of that functional group option code will be 99, 00, or XX. The following list shows only the first two digits of the code numbers. For future reference such as ordering repair parts, it is important to have these code numbers available. To ensure this availability, enter the third and fourth digits shown on your engine option code label in the spaces provided on the following page.

An additional option code label may also be delivered (in a plastic bag attached to the engine or inserted in the machine documentation). It is recommended to place this label either on this page of the operators manual or in the Engine Owner's Warranty booklet under Option Codes.

The machine manufacturer may have placed the label in a specific accessible area (inside the enclosure or close to a maintenance area).

Your engine option code label may not contain all option codes if an option has been added after the engine left the producing factory.

If option code label is lost or destroyed, consult your servicing dealer or engine distributor selling the engine for a replacement.

Record your engine Base Code (A) in the spaces provided on next page for easy reference.

Record Keeping

Engine Serial Number: _____ Engine Base Code: _____

Option Codes	Description	Option Codes	Description
11_____	Rocker Arm Cover	37_____	Fuel Transfer Pump
12_____	Oil Filter Inlet	40_____	Oil Dipstick
13_____	Crankshaft Pulley	41_____	Front Auxiliary Drive
14_____	Flywheel Housing	43_____	Starting Aid
15_____	Flywheel	44_____	Timing Gear Cover With Gears
16_____	Fuel Injection Pump	46_____	Cylinder Block and Liners
17_____	Air Inlet	47_____	Crankshaft and Bearings
18_____	Air Cleaner	48_____	Connecting Rods and Pistons
19_____	Oil Pan	49_____	Valve Actuating Mechanisms
20_____	Coolant Pump	50_____	Oil Pump
21_____	Thermostat Cover	51_____	Cylinder Head With Valves
22_____	Thermostat	52_____	Auxiliary Drive Adapters
23_____	Fan Drive	55_____	Shipping Stand
24_____	Fan Belt	56_____	Paint Option
25_____	Fan	59_____	Oil Cooler and Filter
26_____	Engine Coolant Heater	62_____	Alternator Mounting
27_____	Radiator	64_____	Exhaust Elbow
28_____	Exhaust Manifold	65_____	Turbocharger
29_____	Ventilator System	66_____	Temperature Sensor/Switch
30_____	Starter Motor	69_____	Engine Serial Number Plate
31_____	Alternator	75_____	Air Restriction Indicator
32_____	Instrument Panel	76_____	Oil Pressure Sensor/Switch
35_____	Fuel Filter	95_____	Special Equipment (Factory Installed)
36_____	Front Plate	97_____	Special Equipment (Field Installed Kits)
		98_____	Shipping

NOTE: These option codes are based on the latest information available at the time of publication.

The right is reserved to make changes at any time without notice.

RECORD FUEL INJECTION PUMP MODEL NUMBER

Record the fuel injection pump model and serial information found on the serial number plate (A).

Model No. _____ RPM _____

Manufacturer's No. _____

Serial No. _____

A—Serial Number Plate

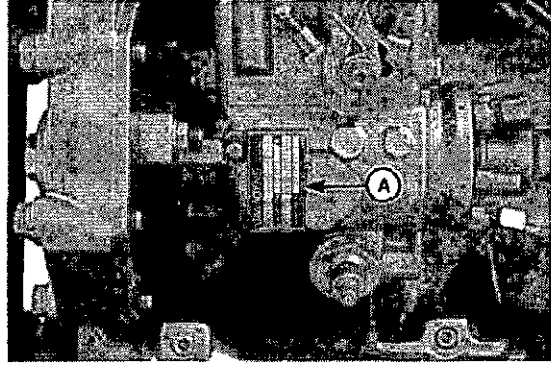

RG11526 -UN-01DEC00

Injection Pump Serial Number Plate

RG, RG34710, 5005 -19-30JAN98-1/1

Safety

RECOGNIZE SAFETY INFORMATION

This is a safety-alert symbol. When you see this symbol on your machine or in this manual, be alert to the potential for personal injury.

Follow recommended precautions and safe operating practices.



T81388 -UN-07DEC88

DX,ALERT -19-29SEP98-1/1

UNDERSTAND SIGNAL WORDS

A signal word—DANGER, WARNING, or CAUTION—is used with the safety-alert symbol. DANGER identifies the most serious hazards.

DANGER or WARNING safety signs are located near specific hazards. General precautions are listed on CAUTION safety signs. CAUTION also calls attention to safety messages in this manual.

▲ DANGER

▲ WARNING

▲ CAUTION

TS187 -19-30SEP88

DX,SIGNAL -19-03MAR93-1/1

FOLLOW SAFETY INSTRUCTIONS

Carefully read all safety messages in this manual and on your machine safety signs. Keep safety signs in good condition. Replace missing or damaged safety signs. Be sure new equipment components and repair parts include the current safety signs. Replacement safety signs are available from your John Deere dealer.

Learn how to operate the machine and how to use controls properly. Do not let anyone operate without instruction.

Keep your machine in proper working condition. Unauthorized modifications to the machine may impair the function and/or safety and affect machine life.

If you do not understand any part of this manual and need assistance, contact your John Deere dealer.



TS201 -UN-23AUG88

DX,READ -19-03MAR93-1/1

REPLACE SAFETY SIGNS

Replace missing or damaged safety signs. See the machine operator's manual for correct safety sign placement.

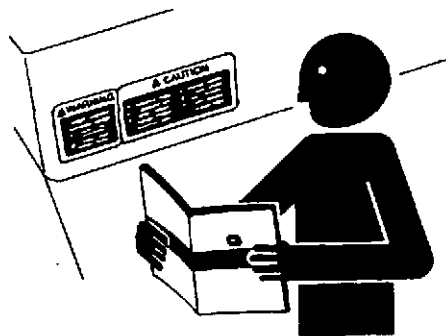

DX,SIGNS1 -19-04JUN90-1/1

TS201 -UN-23AUG88

PREVENT BYPASS STARTING

Avoid possible injury or death from engine runaway.

Do not start engine by shorting across starter terminal. Engine will start with PTO engaged if normal circuitry is bypassed.

Start engine only from operator's station with PTO disengaged or in neutral.

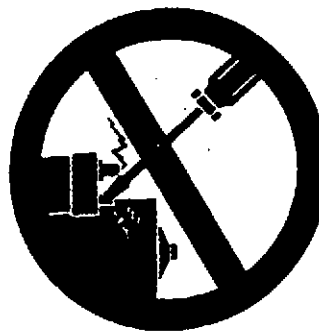

Prevent Bypass Starting

OJOD013,0000001 -19-28NOV00-1/1

RG5419 -UN-28FEB89

HANDLE FUEL SAFELY—AVOID FIRES

Handle fuel with care: it is highly flammable. Do not refuel the machine while smoking or when near open flame or sparks.

Always stop engine before refueling machine. Fill fuel tank outdoors.

Prevent fires by keeping machine clean of accumulated trash, grease, and debris. Always clean up spilled fuel.



DX,FIRE1 -19-03MAR93-1/1

TS202 -UN-23AUG88

PREPARE FOR EMERGENCIES

Be prepared if a fire starts.

Keep a first aid kit and fire extinguisher handy.

Keep emergency numbers for doctors, ambulance service, hospital, and fire department near your telephone.

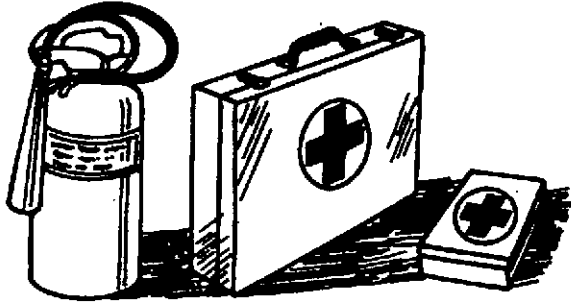

TS291 -JUN-23AUG88

DX.FIRE2 -19-03MAR93-1/1

HANDLE STARTING FLUID SAFELY

Starting fluid is highly flammable.

Keep all sparks and flame away when using it. Keep starting fluid away from batteries and cables.

To prevent accidental discharge when storing the pressurized can, keep the cap on the container, and store in a cool, protected location.

Do not incinerate or puncture a starting fluid container.



TS1356 -JUN-18MAR92

DX.FIRE3 -19-16APR92-1/1

HANDLE FLUIDS SAFELY—AVOID FIRES

When you work around fuel, do not smoke or work near heaters or other fire hazards.

Store flammable fluids away from fire hazards. Do not incinerate or puncture pressurized containers.

Make sure machine is clean of trash, grease, and debris.

Do not store oily rags; they can ignite and burn spontaneously.



TS227 -JUN-23AUG88

DX.FLAME -19-29SEP96-1/1

SERVICE MACHINES SAFELY

Tie long hair behind your head. Do not wear a necktie, scarf, loose clothing, or necklace when you work near machine tools or moving parts. If these items were to get caught, severe injury could result.

Remove rings and other jewelry to prevent electrical shorts and entanglement in moving parts.

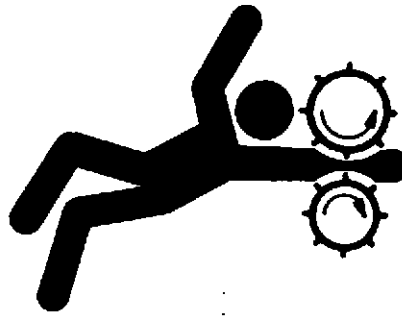

TS228 -UN-23AUG88

DX,LOOSE -19-04JUN90-1/1

WEAR PROTECTIVE CLOTHING

Wear close fitting clothing and safety equipment appropriate to the job.

Prolonged exposure to loud noise can cause impairment or loss of hearing.

Wear a suitable hearing protective device such as earmuffs or earplugs to protect against objectionable or uncomfortable loud noises.

Operating equipment safely requires the full attention of the operator. Do not wear radio or music headphones while operating machine.

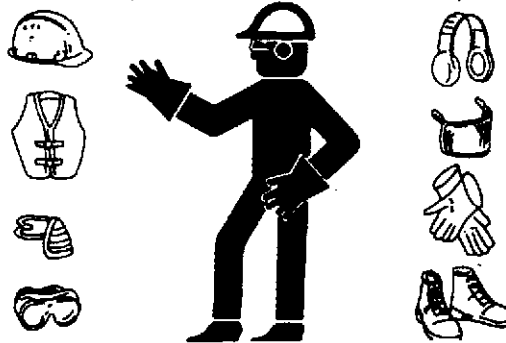

TS206 -UN-23AUG88

DX,WEAR -19-10SEP90-1/1

PROTECT AGAINST NOISE

Prolonged exposure to loud noise can cause impairment or loss of hearing.

Wear a suitable hearing protective device such as earmuffs or earplugs to protect against objectionable or uncomfortable loud noises.



TS207 -UN-23AUG88

DX,NOISE -19-03MAR93-1/1

HANDLE CHEMICAL PRODUCTS SAFELY

Direct exposure to hazardous chemicals can cause serious injury. Potentially hazardous chemicals used with John Deere equipment include such items as lubricants, coolants, paints, and adhesives.

A Material Safety Data Sheet (MSDS) provides specific details on chemical products: physical and health hazards, safety procedures, and emergency response techniques.

Check the MSDS before you start any job using a hazardous chemical. That way you will know exactly what the risks are and how to do the job safely. Then follow procedures and recommended equipment.

(See your John Deere dealer for MSDS's on chemical products used with John Deere equipment.)

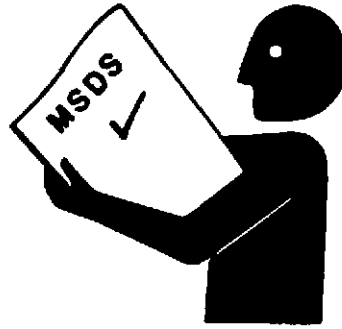

TS1132 -UN-26NOV90

DX,MSDS,NA -19-03MAR93-1/1

STAY CLEAR OF ROTATING DRIVELINES

Entanglement in rotating driveline can cause serious injury or death.

Keep tractor master shield and driveline shields in place at all times. Make sure rotating shields turn freely.

Wear close fitting clothing. Stop the engine and be sure PTO driveline is stopped before making adjustments, connections, or cleaning out PTO driven equipment.



TS1644 -UN-22AUG85

DX,PTO -19-12SEP95-1/1

PRACTICE SAFE MAINTENANCE

Understand service procedure before doing work. Keep area clean and dry.

Never lubricate, service, or adjust machine while it is moving. Keep hands, feet, and clothing from power-driven parts. Disengage all power and operate controls to relieve pressure. Lower equipment to the ground. Stop the engine. Remove the key. Allow machine to cool.

Securely support any machine elements that must be raised for service work.

Keep all parts in good condition and properly installed. Fix damage immediately. Replace worn or broken parts. Remove any buildup of grease, oil, or debris.

On self-propelled equipment, disconnect battery ground cable (-) before making adjustments on electrical systems or welding on machine.

On towed implements, disconnect wiring harnesses from tractor before servicing electrical system components or welding on machine.



TS218 -UN-23AUG88

DX,SERV -19-17FEB99-1/1

WORK IN VENTILATED AREA

Engine exhaust fumes can cause sickness or death. If it is necessary to run an engine in an enclosed area, remove the exhaust fumes from the area with an exhaust pipe extension.

If you do not have an exhaust pipe extension, open the doors and get outside air into the area.

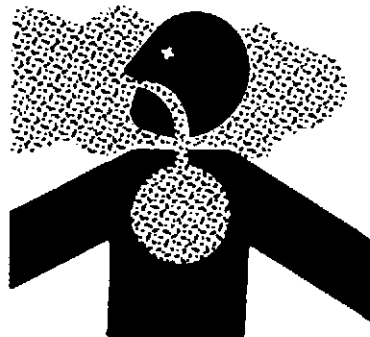

TS220 -UN-23AUG88

DX,AIR -19-17FEB99-1/1

AVOID HIGH-PRESSURE FLUIDS

Escaping fluid under pressure can penetrate the skin causing serious injury.

Avoid the hazard by relieving pressure before disconnecting hydraulic or other lines. Tighten all connections before applying pressure.

Search for leaks with a piece of cardboard. Protect hands and body from high pressure fluids.

If an accident occurs, see a doctor immediately. Any fluid injected into the skin must be surgically removed within a few hours or gangrene may result. Doctors unfamiliar with this type of injury should reference a knowledgeable medical source. Such information is available from Deere & Company Medical Department in Moline, Illinois, U.S.A.

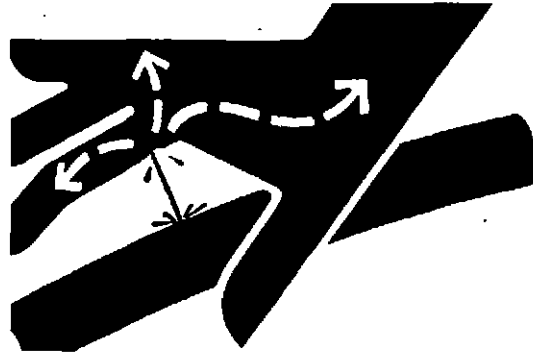

X9511 -JUN-23AUG88

DX,FLUID -19-03MAR93-1/1

AVOID HEATING NEAR PRESSURIZED FLUID LINES

Flammable spray can be generated by heating near pressurized fluid lines, resulting in severe burns to yourself and bystanders. Do not heat by welding, soldering, or using a torch near pressurized fluid lines or other flammable materials. Pressurized lines can be accidentally cut when heat goes beyond the immediate flame area.



TS953 -JUN-15MAY90

DX,TORCH -19-03MAR93-1/1

USE PROPER LIFTING EQUIPMENT

Lifting heavy components incorrectly can cause severe injury or machine damage.

Follow recommended procedure for removal and installation of components in the manual.

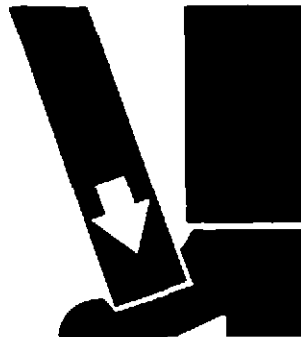

TS226 -JUN-23AUG88

DX,LIFT -19-04JUN90-1/1

REMOVE PAINT BEFORE WELDING OR HEATING

Avoid potentially toxic fumes and dust.

Hazardous fumes can be generated when paint is heated by welding, soldering, or using a torch.

Remove paint before heating:

- Remove paint a minimum of 76 mm (3 in.) from area to be affected by heating.
- If you sand or grind paint, avoid breathing the dust. Wear an approved respirator.
- If you use solvent or paint stripper, remove stripper with soap and water before welding. Remove solvent or paint stripper containers and other flammable material from area. Allow fumes to disperse at least 15 minutes before welding or heating.

Do all work in an area that is ventilated to carry toxic fumes and dust away.

Dispose of paint and solvent properly.

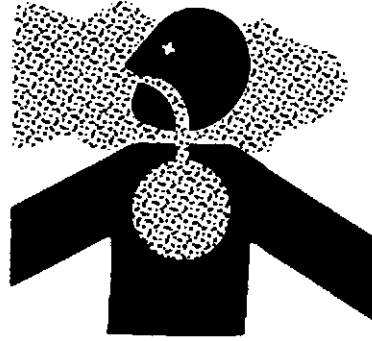

TS220 -UN-23AUG88

DX.PAINT -19-22OCT89-1/1

SERVICE COOLING SYSTEM SAFELY

Explosive release of fluids from pressurized cooling system can cause serious burns.

Shut off engine. Only remove filler cap when cool enough to touch with bare hands. Slowly loosen cap to first stop to relieve pressure before removing completely.



TS281 -UN-23AUG88

DX.RCAP -19-04JUN80-1/1

AVOID HARMFUL ASBESTOS DUST

Avoid breathing dust that may be generated when handling components containing asbestos fibers. Inhaled asbestos fibers may cause lung cancer.

Components in products that may contain asbestos fibers are brake pads, brake band and lining assemblies, clutch plates, and some gaskets. The asbestos used in these components is usually found in a resin or sealed in some way. Normal handling is not hazardous as long as airborne dust containing asbestos is not generated.

Avoid creating dust. Never use compressed air for cleaning. Avoid brushing or grinding material containing asbestos. When servicing, wear an approved respirator. A special vacuum cleaner is recommended to clean asbestos. If not available, apply a mist of oil or water on the material containing asbestos.

Keep bystanders away from the area.

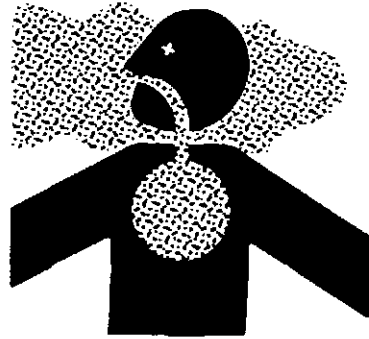

TS220 -JUN-23AUG88

DX,DUST -19-15MAR91-1/1

PREVENT BATTERY EXPLOSIONS

Keep sparks, lighted matches, and open flame away from the top of battery. Battery gas can explode.

Never check battery charge by placing a metal object across the posts. Use a volt-meter or hydrometer.

Do not charge a frozen battery; it may explode. Warm battery to 16°C (60°F).



TS204 -JUN-23AUG88

DX,SPARKS -19-03MAR93-1/1

PREVENT ACID BURNS

Sulfuric acid in battery electrolyte is poisonous. It is strong enough to burn skin, eat holes in clothing, and cause blindness if splashed into eyes.

Avoid the hazard by:

1. Filling batteries in a well-ventilated area.
2. Wearing eye protection and rubber gloves.
3. Avoiding breathing fumes when electrolyte is added.
4. Avoiding spilling or dripping electrolyte.
5. Use proper jump start procedure.

If you spill acid on yourself:

1. Flush your skin with water.
2. Apply baking soda or lime to help neutralize the acid.
3. Flush your eyes with water for 15—30 minutes. Get medical attention immediately.

If acid is swallowed:

1. Do not induce vomiting.
2. Drink large amounts of water or milk, but do not exceed 2 L (2 quarts).
3. Get medical attention immediately.

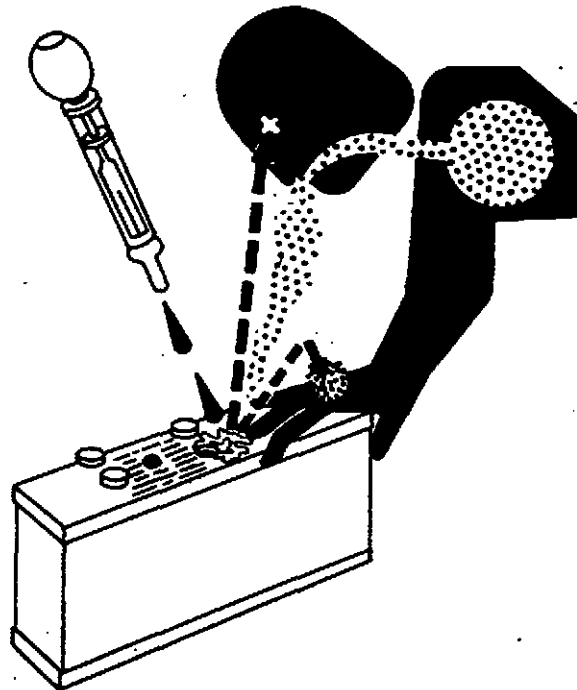

TS203 -UN-23AUG88

DX.POISON -19-21APR93-1/1

PROTECT AGAINST HIGH PRESSURE SPRAY

Spray from high pressure nozzles can penetrate the skin and cause serious injury. Keep spray from contacting hands or body.

If an accident occurs, see a doctor immediately. Any high pressure spray injected into the skin must be surgically removed within a few hours or gangrene may result. Doctors unfamiliar with this type of injury should reference a knowledgeable medical source. Such information is available from Deere & Company Medical Department in Moline, Illinois, U.S.A.



TS1343 -UN-18MAR92

DX.SPRAY -19-16APR92-1/1

USE PROPER TOOLS

Use tools appropriate to the work. Makeshift tools and procedures can create safety hazards.

Use power tools only to loosen threaded parts and fasteners.

For loosening and tightening hardware, use the correct size tools. DO NOT use U.S. measurement tools on metric fasteners. Avoid bodily injury caused by slipping wrenches.

Use only service parts meeting John Deere specifications.



TS779 -JUN-08NOV89

DX,REPAIR -19-17FEB89-1/1

DISPOSE OF WASTE PROPERLY

Improperly disposing of waste can threaten the environment and ecology. Potentially harmful waste used with John Deere equipment include such items as oil, fuel, coolant, brake fluid, filters, and batteries.

Use leakproof containers when draining fluids. Do not use food or beverage containers that may mislead someone into drinking from them.

Do not pour waste onto the ground, down a drain, or into any water source.

Air conditioning refrigerants escaping into the air can damage the Earth's atmosphere. Government regulations may require a certified air conditioning service center to recover and recycle used air conditioning refrigerants.

Inquire on the proper way to recycle or dispose of waste from your local environmental or recycling center, or from your John Deere dealer.

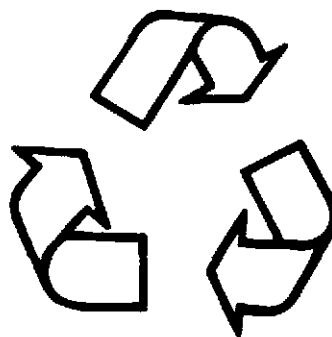

TS1133 -JUN-26NOV90

DX,DRAIN -19-03MAR93-1/1

Fuels, Lubricants, and Coolant

DIESEL FUEL

Consult your local fuel distributor for properties of the diesel fuel available in your area.

In general, diesel fuels are blended to satisfy the low temperature requirements of the geographical area in which they are marketed.

Diesel fuels specified to EN 590 or ASTM D975 are recommended.

In all cases, the fuel shall meet the following properties:

Cetane number of 40 minimum. Cetane number greater than 50 is preferred, especially for temperatures below -20°C (-4°F) or elevations above 1500 m (5000 ft).

Cold Filter Plugging Point (CFPP) below the expected low temperature **OR Cloud Point** at least 5°C (9°F) below the expected low temperature.

Fuel lubricity should pass a minimum of 3100 gram load level as measured by the BOCLE scuffing test.

Sulfur content:

- Sulfur content should not exceed 0.5%. Sulfur content less than 0.05% is preferred.
- If diesel fuel with sulfur content greater than 0.5% sulfur content is used, reduce the service interval for engine oil and filter by 50%.
- **DO NOT** use diesel fuel with sulfur content greater than 1.0%.

Bio-diesel fuels may be used **ONLY** if the fuel properties meet DIN 51606 or equivalent specification.

DO NOT mix used engine oil or any other type of lubricant with diesel fuel.

DX,FUEL1 -19-24JAN00-1/1

LUBRICITY OF DIESEL FUEL

Diesel fuel must have adequate lubricity to ensure proper operation and durability of fuel injection system components.

Diesel fuels for highway use in the United States and Canada require sulfur content less than 0.05%.

Diesel fuel in the European Union requires sulfur content less than 0.05%.

Experience shows that some low sulfur diesel fuels may have inadequate lubricity and their use may reduce performance in fuel injection systems due to inadequate lubrication of injection pump components. The lower concentration of aromatic compounds in these fuels also adversely affects injection pump seals and may result in leaks.

Use of low lubricity diesel fuels may also cause accelerated wear, injection nozzle erosion or corrosion, engine speed instability, hard starting, low power, and engine smoke.

Fuel lubricity should pass a minimum of 3100 gram load level as measured by the BOCLE scuffing test.

ASTM D975 and EN 590 specifications do not require fuels to pass a fuel lubricity test.

If fuel of low or unknown lubricity is used, add John Deere PREMIUM DIESEL FUEL CONDITIONER (or equivalent) at the specified concentration.

DX,FUEL5 -19-24JAN00-1/1

DIESEL FUEL STORAGE

Proper fuel storage is critically important. Use clean storage and transfer tanks. Periodically drain water and sediment from bottom of tank. Store fuel in a convenient place away from buildings.

IMPORTANT: DO NOT store diesel fuel in galvanized containers. Diesel fuel stored in galvanized containers reacts with zinc coating on container to form zinc flakes. If fuel contains water, a zinc gel will also form. The gel and flakes will quickly plug fuel filters, damage injection nozzles and injection pump.

DO NOT use brass-coated containers for fuel storage. Brass is an alloy of copper and zinc.

Store diesel fuel in plastic, aluminum, and steel containers specially coated for diesel fuel storage.

Avoid storing fuel over long periods of time. If fuel is stored for more than a month prior to use, or there is a slow turnover in fuel tank or supply tank, add a fuel conditioner such as John Deere PREMIUM DIESEL FUEL CONDITIONER or equivalent to stabilize the fuel and prevent water condensation. John Deere PREMIUM DIESEL FUEL CONDITIONER is available in winter and summer formulas. Fuel conditioner also reduces fuel gelling and controls wax separation during cold weather.

Consult your John Deere engine distributor or servicing dealer for recommendations and local availability. Always follow manufacturer's directions on label.

RG.RG34710.5027 -19-30JAN98-1/1

DIESELSCAN FUEL ANALYSIS

DIESELSCAN™ is a John Deere fuel sampling program to help you monitor the quality of your fuel source. It verifies fuel type, cleanliness, water content, suitability for cold weather operation, and if fuel is within ASTM specifications. Check with your John Deere dealer for availability of DIESELSCAN kits.

DIESELSCAN is a trademark of Deere & Company

DX.FUEL6 -19-06DEC00-1/1

MINIMIZING THE EFFECT OF COLD WEATHER ON DIESEL ENGINES

John Deere diesel engines are designed to operate effectively in cold weather.

However, for effective starting and cold weather operation, a little extra care is necessary. The information below outlines steps that can minimize the effect that cold weather may have on starting and operation of your engine. See your authorized engine distributor or servicing dealer for additional information and local availability of cold weather aids.

Use Grade No. 1-D Fuel

When temperatures fall below 5°C (40°F), Grade No. 1-D fuel is best suited for cold weather operation. *Grade No. 1-D fuel has a lower cloud point and a lower pour point.*

Cloud point is the temperature at which wax will begin to form in the fuel and this wax causes fuel filters to plug. **Pour point** is the temperature at which fuel begins to thicken and become more resistant to flow through fuel pumps and lines.

NOTE: On an average, Grade No. 1-D fuel has a lower BTU (heat content) rating than Grade No. 2-D fuel. When using Grade No. 1-D fuel you may notice a drop in power and fuel efficiency, but should not experience any other engine performance effects. Check the grade of fuel being used before troubleshooting for low power complaints in cold weather operation.

Seasonal Viscosity Oil and Proper Coolant Concentration

Use seasonal grade viscosity engine oil based on expected air temperature range between oil changes

and a proper concentration of low silicate antifreeze as recommended. (See DIESEL ENGINE OIL and ENGINE COOLANT REQUIREMENTS later in this section).

Diesel Fuel Flow Additive

IMPORTANT: Treat fuel when outside temperature drops below 0°C (32°F). For best results, use with untreated fuel. Follow all recommended instructions on label.

Use John Deere Premium Diesel Fuel Conditioner (Winter) or equivalent to treat fuel during the cold weather season. *This winter formulation is a combination diesel fuel conditioner and anti-gel additive.*

Coolant Heaters

Engine block heaters (coolant) are an available option to aid cold weather starting.

Intake Air Heaters

An electric air heater option consisting of a 12-volt, 700-watt (24-volt, 480-watt) heating element installed in the cylinder head is available.

Ether Injectors

John Deere solenoid-powered ether aid kits deliver ether to intake manifold by depressing a button. Ether should be injected in short bursts only, from immediately after cranking until when the engine starts and runs.

Continued on next page

RG.RG34710.5029 -19-30JAN98-1/2

IMPORTANT: If too much ether is injected it can prevent proper cranking and cause engine damage.

Winterfronts

Use of fabric, cardboard, or solid winterfronts is not recommended with any John Deere engine. Their use can result in excessive engine coolant, oil, and charge air temperatures. This can lead to reduced engine life, loss of power and poor fuel economy. Winterfronts may also put abnormal stress on fan and fan drive components potentially causing premature failures.

If winterfronts are used, they should never totally close off the grill frontal area. Approximately 25% area in the center of the grill should remain open at all times. At no time should the air blockage device be applied directly to the radiator core.

Radiator Shutters

If equipped with a thermostatically controlled radiator shutter system, this system should be regulated in such a way that the shutters are completely open by the time the coolant reaches 93°C (200°F) to prevent excessive intake manifold temperatures. Manually controlled systems are not recommended.

If air-to-air aftercooling is used, the shutters must be completely open by the time the intake manifold air temperature reaches the maximum allowable temperature out of the charge air cooler.

For more information, see your John Deere engine distributor or servicing dealer.

RG, RG34710, 5029 -19-30JAN98-2/2

DIESEL ENGINE BREAK-IN OIL

New engines are filled at the factory with John Deere ENGINE BREAK-IN OIL. During the break-in period, add John Deere ENGINE BREAK-IN OIL as needed to maintain the specified oil level.

Change the oil and filter after the first 100 hours of operation of a new or rebuilt engine.

After engine overhaul, fill the engine with John Deere ENGINE BREAK-IN OIL.

If John Deere ENGINE BREAK-IN OIL is not available, use a diesel engine oil meeting one of the following during the first 100 hours of operation:

- API Service Classification CE

- ACEA Specification E1

After the break-in period, use John Deere PLUS-50[®] or other diesel engine oil as recommended in this manual.

IMPORTANT: Do not use PLUS-50 oil or engine oils meeting API CH-4, API CG4, API CF4, ACEA E3, or ACEA E2 performance levels during the first 100 hours of operation of a new or rebuilt engine. These oils will not allow the engine to break-in properly.

PLUS-50 is a registered trademark of Deere & Company.

DX, ENOIL4 -19-24JAN00-1/1

DIESEL ENGINE OIL

Use oil viscosity based on the expected air temperature range during the period between oil changes.

The following oil is preferred:

- John Deere PLUS-50[®]

The following oil is also recommended:

- John Deere TORQ-GARD SUPREME[®]

Other oils may be used if they meet one or more of the following:

- API Service Classification CH-4
- API Service Classification CG-4
- API Service Classification CF-4
- ACEA Specification E3
- ACEA Specification E2

Multi-viscosity diesel engine oils are preferred.

If diesel fuel with sulfur content greater than 0.5% is used, reduce the service interval by 50%.

Extended service intervals may apply when John Deere preferred engine oils are used. Consult your John Deere dealer for more information.

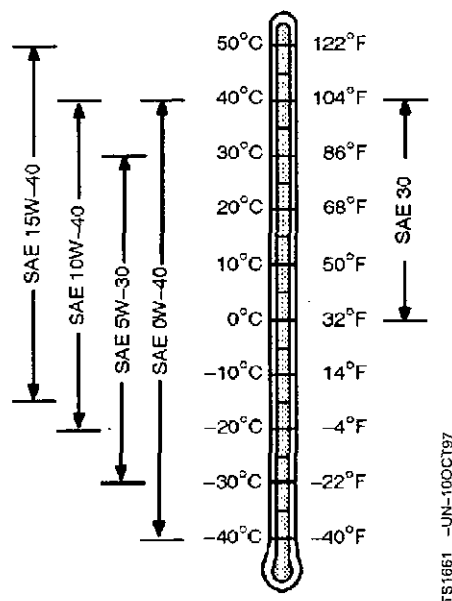

PLUS-50 is a registered trademark of Deere & Company.
 TORQ-GARD SUPREME is a registered trademark of Deere & Company

DX.ENOIL -19-24JAN00-1/1

EXTENDED DIESEL ENGINE OIL SERVICE INTERVALS

When John Deere PLUS-50® oil and the specified John Deere filter are used, the service interval for engine oil and filter changes may be increased by 50%.

If other than PLUS-50® oil and the specified John Deere filter are used, change the engine oil and filter at the normal service interval.

PLUS-50 is a registered trademark of Deere & Company

DX,ENOil6 -19-10OCT97-1/1

MIXING OF LUBRICANTS

In general, avoid mixing different brands or types of oil. Oil manufacturers blend additives in their oils to meet certain specifications and performance requirements.

Consult your John Deere dealer to obtain specific information and recommendations.

Mixing different oils can interfere with the proper functioning of these additives and degrade lubricant performance.

DX,LUBMIX -19-18MAR96-1/1

OILSCAN® AND COOLSCAN®

OILSCAN® and COOLSCAN® are John Deere sampling programs to help you monitor machine performance and identify potential problems before they cause serious damage.

Oil and coolant samples should be taken from each system prior to its recommended change interval.

Check with your John Deere dealer for the availability of OILSCAN® and COOLSCAN® kits.

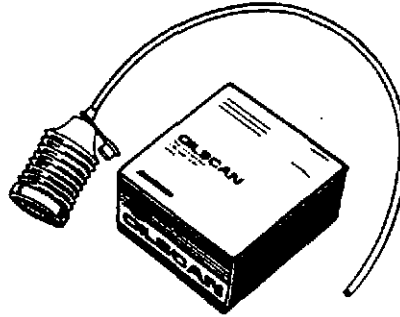

T6829AB -JUN-15JUN89

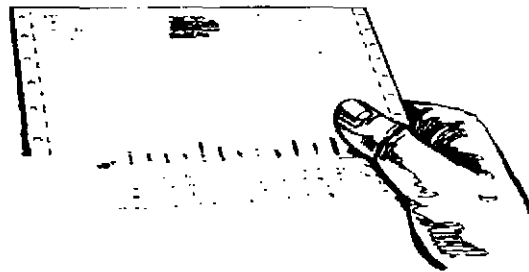

T6829AB -JUN-18OCT88

*OILSCAN is a registered trademark of Deere & Company.
COOLSCAN is a registered trademark of Deere & Company*

DX,OILSCAN -19-16APR92-1/1

ALTERNATIVE AND SYNTHETIC LUBRICANTS

Conditions in certain geographical areas may require lubricant recommendations different from those printed in this manual.

Some John Deere brand coolants and lubricants may not be available in your location.

Consult your John Deere dealer to obtain information and recommendations.

Synthetic lubricants may be used if they meet the performance requirements as shown in this manual.

The temperature limits and service intervals shown in this manual apply to both conventional and synthetic oils.

Re-refined base stock products may be used if the finished lubricant meets the performance requirements.

DX,ALTER -19-15JUN00-1/1

LUBRICANT STORAGE

Your equipment can operate at top efficiency only when clean lubricants are used.

Use clean containers to handle all lubricants.

Whenever possible, store lubricants and containers in an area protected from dust, moisture, and other contamination. Store containers on their side to avoid water and dirt accumulation.

Make certain that all containers are properly marked to identify their contents.

Properly dispose of all old containers and any residual lubricant they may contain.

DX,LUBST -19-18MAR96-1/1

GREASE

Use grease based on NLGI consistency numbers and the expected air temperature range during the service interval.

The following greases are preferred:

• John Deere SD POLYUREA GREASE

The following greases are also recommended:

- John Deere HD MOLY GREASE
- John Deere HD LITHIUM COMPLEX GREASE
- John Deere HD WATER RESISTANT GREASE
- John Deere GREASE-GARD

Other greases may be used if they meet the following:

- NLGI Performance Classification GC-LB

IMPORTANT: Some types of grease thickener are not compatible with others. Consult your grease supplier before mixing different types of grease.

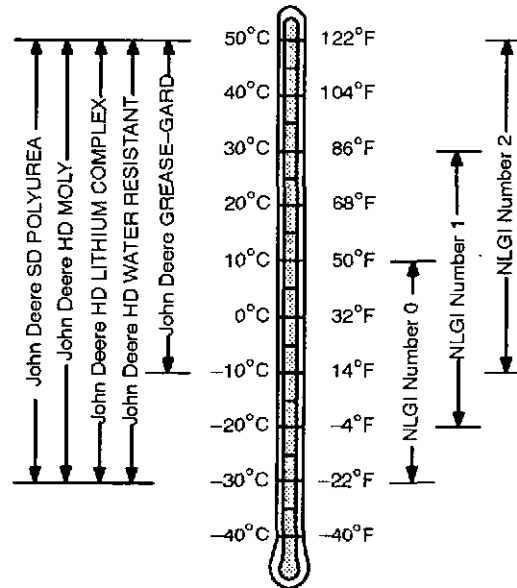

TS1667 -UN-30JUN99

DX,GRE1 -19-24JAN00-1/1

DIESEL ENGINE COOLANT

The engine cooling system is filled to provide year-round protection against corrosion and cylinder liner pitting, and winter freeze protection to -37°C (-34°F).

The following engine coolant is preferred for service:

- John Deere COOL-GARD Prediluted Coolant

The following engine coolant is also recommended:

- John Deere COOL-GARD Coolant Concentrate in a 40 to 60% mixture of concentrate with quality water.

Other low silicate ethylene glycol base coolants for heavy-duty engines may be used if they meet one of the following specifications:

- ASTM D5345 (prediluted coolant)
- ASTM D4985 (coolant concentrate) in a 40 to 60% mixture of concentrate with quality water

Coolants meeting these specifications require use of supplemental coolant additives, formulated for heavy-duty diesel engines, for protection against corrosion and cylinder liner erosion and pitting.

A 50% mixture of ethylene glycol engine coolant in water provides freeze protection to -37°C (-34°F). If

protection at lower temperatures is required, consult your John Deere dealer for recommendations.

Water quality is important to the performance of the cooling system. Distilled, deionized, or demineralized water is recommended for mixing with ethylene glycol base engine coolant concentrate.

IMPORTANT: Do not use cooling system sealing additives or antifreeze that contains sealing additives.

Coolant Drain Intervals

Drain the factory fill engine coolant, flush the cooling system, and refill with new coolant after the first 3 years or 3000 hours of operation. Subsequent drain intervals are determined by the coolant used for service. At each interval, drain the coolant, flush the cooling system, and refill with new coolant.

When John Deere COOL-GARD is used, the drain interval may be extended to 5 years or 5000 hours of operation, provided that the coolant is tested annually AND additives are replenished, as needed, by adding a supplemental coolant additive.

If COOL-GARD is not used, the drain interval is reduced to 2 years or 2000 hours of operation.

DX,COOL3 -19-05FE689-1/1

DIESEL ENGINE COOLANTS, SUPPLEMENTAL ADDITIVE INFORMATION

Engine coolants are a combination of three chemical components: ethylene glycol (antifreeze), inhibiting coolant additives, and quality water.

Coolant Specifications

Some products, including John Deere John Deere COOL-GARD Prediluted Coolant, are fully formulated coolants that contain all three components in their correct concentrations. Do not add an initial charge of supplemental coolant additives to these fully formulated products.

Some coolant concentrates, including John Deere COOL-GARD Coolant Concentrate, contain both ethylene glycol antifreeze and inhibiting coolant additives. Mix these products and quality water, but do not add an initial charge of supplemental coolant additives.

Coolants meeting ASTM D5345 (prediluted coolant) or ASTM D4985 (coolant concentrate) require an initial charge of supplemental coolant additives.

Replenish Coolant Additives

The concentration of coolant additives is gradually depleted during engine operation. Periodic replenishment of inhibitors is required, even when John Deere COOL-GARD is used. Follow the recommendations in this manual for the use of supplemental coolant additives.

Why Use Supplemental Coolant Additives?

Operating without proper coolant additives will result in increased corrosion, cylinder liner erosion and pitting, and other damage to the engine and cooling system. A simple mixture of ethylene glycol and water will not give adequate protection.

Use of supplemental coolant additives reduces corrosion, erosion, and pitting. These chemicals reduce the number of vapor bubbles in the coolant and

help form a protective film on cylinder liner surfaces. This film acts as a barrier against the harmful effects of collapsing vapor bubbles.

Avoid Automotive-Type Coolants

Never use automotive-type coolants (such as those meeting ASTM D3306 or ASTM D4656). These coolants do not contain the correct additives to protect heavy-duty diesel engines. They often contain a high concentration of silicates and may damage the engine or cooling system.

Water Quality

Water quality is important to the performance of the cooling system. Distilled, deionized, or demineralized water is recommended for mixing with ethylene glycol base engine coolant concentrate. All water used in the cooling system should meet the following minimum specifications for quality:

Chlorides	<40 mg/L
Sulfates	<100 mg/L
Total Dissolved Solids	<340 mg/L
Total Hardness	<170 mg/L
pH	5.5 to 9.0

Freeze Protection

The relative concentrations of ethylene glycol and water in the engine coolant determine its freeze protection limit.

Ethylene Glycol	Freeze Protection Limit
40%	-24°C (-12°F)
50%	-37°C (-34°F)
60%	-52°C (-62°F)

DO NOT use a coolant-water mixture greater than 60% ethylene glycol.

TESTING DIESEL ENGINE COOLANT

Maintaining adequate concentrations of glycol and inhibiting additives in the coolant is critical to protect the engine and cooling system against freezing, corrosion, and cylinder liner erosion and pitting.

Test the coolant solution at intervals of 12 months or less and whenever excessive coolant is lost through leaks or overheating.

DX,COOL9 -19-17FEB99-1/3

Coolant Test Strips

Coolant test strips are available from your John Deere dealer. These test strips provide a simple, effective method to check the freeze point and additive levels of your engine coolant.

Compare the results to the supplemental coolant additive (SCA) chart to determine the amount of inhibiting additives in your coolant and whether more John Deere COOLANT CONDITIONER should be added.

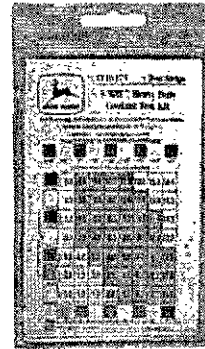

Coolant Test Strips

RG7387 -JUN-22SEP99

DX,COOL9 -19-17FEB99-2/3

COOLSCAN

For a more thorough evaluation of your coolant, perform a COOLSCAN analysis. See your John Deere dealer for information about COOLSCAN.

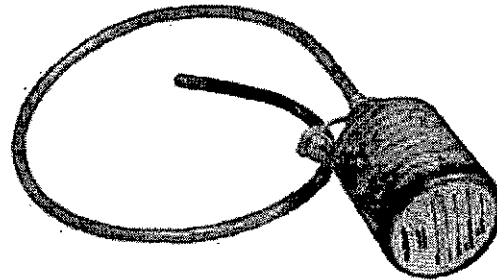

COOLSCAN Sampling

RG7387 -JUN-05DEC97

DX,COOL9 -19-17FEB99-3/3

REPLENISHING SUPPLEMENTAL COOLANT ADDITIVES (SCAs) BETWEEN COOLANT CHANGES

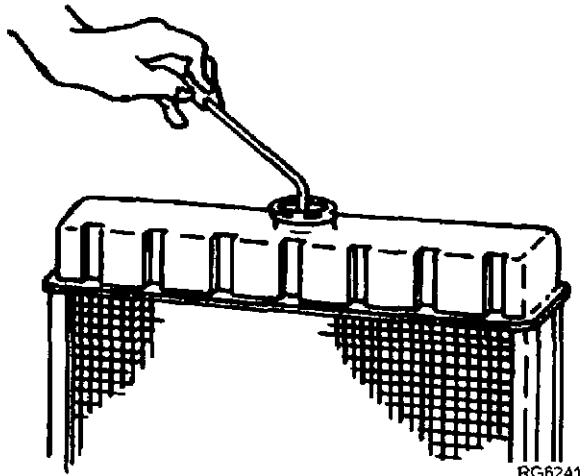

Sampling of Coolant

IMPORTANT: Do not add supplemental coolant additives when the cooling system is drained and refilled with John Deere COOL-GARD®.

Through time and use, the concentration of coolant additives is gradually depleted during engine operation. Periodic replenishment of inhibitors is required, even when John Deere COOL-GARD® is used. The cooling system must be recharged with additional supplemental coolant additives available in the form of liquid coolant conditioner.

Maintaining the correct coolant conditioner concentration (SCAs) and freeze point is essential in your cooling system to protect against rust, liner pitting and corrosion, and freeze-ups due to incorrect coolant dilution.

John Deere COOLANT CONDITIONER is recommended as a supplemental coolant additive in John Deere engines.

Test the coolant solution at 600 hours or 12 months of operation using either John Deere coolant test strips or

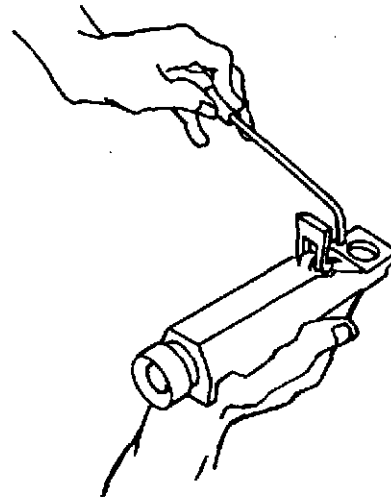

Testing of Coolant for Glycol Concentration

a COOLSCAN® analysis. If a COOLSCAN® analysis is not available, recharge system per instructions printed on label of John Deere Liquid Coolant Conditioner.

IMPORTANT: ALWAYS maintain coolant at correct level and concentration. DO NOT operate engine without coolant for even a few minutes.

If frequent coolant makeup is required, the glycol concentration should be checked with JT07298 Coolant/Battery Tester to assure that the desired freeze point is maintained. Follow manufacturer's instructions provided with Coolant/Battery Tester.

If other coolants are used, consult the coolant supplier and follow the manufacturer's recommendation for use of supplemental coolant additives.

The use of non-recommended supplemental coolant additives may result in additive drop-out and gelation of the coolant.

COOL-GARD is a registered trademark of Deere & Company
COOLSCAN is a registered trademark of Deere & Company

Continued on next page

RG.RG34710,5041 -19-30JAN98-1/2

Add the manufacturer's recommended concentration of supplemental coolant additive. **DO NOT** add more than the recommended amount.

See ENGINE COOLANT SPECIFICATIONS earlier in this section for proper mixing of coolant ingredients before adding to the cooling system.

RG, RG34710.5041 -19-30JAN98-2/2

OPERATING IN WARM TEMPERATURE CLIMATES

John Deere engines are designed to operate using glycol base engine coolants.

Always use a recommended glycol base engine coolant, even when operating in geographical areas where freeze protection is not required.

IMPORTANT: Water may be used as coolant *in emergency situations only*.

Foaming, hot surface aluminum and iron corrosion, scaling, and cavitation will occur when water is used as the coolant, even when coolant conditioners are added.

Drain cooling system and refill with recommended glycol base engine coolant as soon as possible.

DX, COOL6 -19-18MAR96-1/1

DISPOSING OF COOLANT

Improperly disposing of engine coolant can threaten the environment and ecology.

Used leakproof containers when draining fluids. Do not use food or beverage containers that may mislead someone into drinking from them.

Do not pour waste onto the ground, down a drain, or into any water source.

Inquire on the proper way to recycle or dispose of waste from your local environmental or recycling center, or from your John Deere engine distributor or servicing dealer.

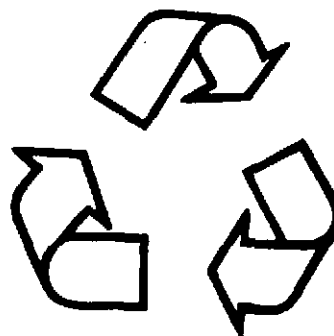

Recycle Waste

T51133 -JUN-26NOV90

OUOD002.000002B -19-24JAN01-1/1

Engine Operating Guidelines

INSTRUMENT (GAUGE) PANELS

IMPORTANT: Any time an electric gauge or meter does not register correctly, replace it with a new one. Do not attempt to repair it.

All controls and gauges are optional equipment for John Deere OEM Engines. They may be provided by the equipment manufacturer instead of John Deere. The following information applies only to those controls and gauges provided by John Deere.

Continued on next page

OLUD002.0000028 -19-18JAN01-1/6

Instrument (Gauge) Panel (North American)

Following is a brief description of the components on the John Deere instrument (gauge) panel:

A—Oil Pressure Gauge - Indicates engine oil pressure.

B—Coolant Temperature Gauge - Indicates the engine coolant temperature.

C—Key Switch - The four position key switch controls the electrical system.

D—Tachometer (optional) - Indicates engine speed in revolutions per minute (rpm).

E—Reset (Safety) Switch - Overrides safety shutdown switch when depressed and held in during engine start-up. Hold button in until engine oil pressure is at a safe operating level.

F—Fuse Holder - Contains 14 amp fuse.

G—Ammeter - Indicates charging current within electrical system.

H—Hour Meter (optional) - Indicates the operating hours of the engine while key switch is in the "ON" position. The hour meter should be used as a guide for scheduling periodic service.

I—Hand Throttle (optional) - Controls engine speed.

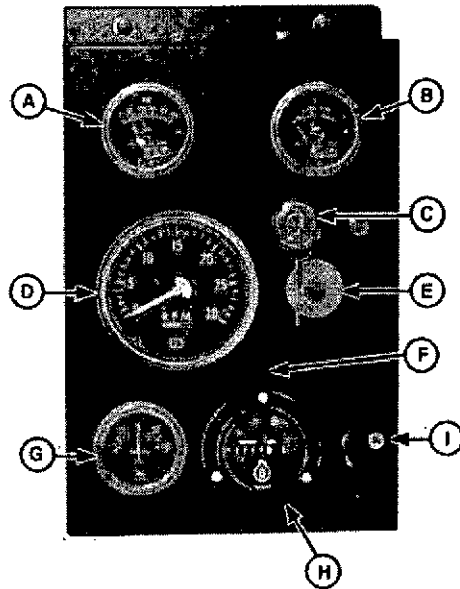

North American Instrument Panel

- A—Oil Pressure Gauge
- B—Coolant Temperature Gauge
- C—Key Switch
- D—Tachometer
- E—Reset (Safety) Switch
- F—Fuse Holder
- G—Ammeter
- H—Hour Meter
- I—Hand Throttle

RG11527 -UN-01DEC00

Continued on next page

CUOD002,0000028 -19-18JAN01-2/6

AEZ Instrument (Gauge) Panel (Except North America)

A—Oil Pressure Gauge - The oil pressure gauge indicates engine oil pressure.

B—Coolant Temperature Gauge - The coolant temperature gauge indicates the engine coolant temperature.

C—Engine Control Light - The engine control light indicates that the engine protection is activated.

D—Oil Pressure Light - The oil pressure light illuminates when the key switch is turned to the CONTROL position. The light will remain on until the engine is started and the specified oil pressure is reached. If oil pressure is lost during engine operation, the light will illuminate and protection circuitry will stop the engine. The oil pressure light will remain on, indicating that the engine was stopped due to a low oil pressure condition.

E—Alternator Light - The alternator light illuminates when the key is turned to the CONTROL position. The light will remain on until the engine is started. After the engine is running, if the alternator stops charging, the light will illuminate and protection circuitry will stop the engine. The alternator light will remain on indicating the engine was stopped due to the alternator not charging.

F—Coolant Temperature Light - The coolant temperature light illuminates only if the engine has overheated. After the engine is running, if the engine overheats, the light will illuminate and protection circuitry will stop the engine. The coolant temperature light will remain on indicating the engine was stopped due to the engine overheating.

G—Fuel Level Light - The fuel level light illuminates only if the engine has stopped due to fuel tank being empty. After the engine is running, if the engine runs out of fuel, the light will illuminate. The fuel level light will remain on indicating the engine was stopped due to the fuel tank being empty.

H—Key Switch - The key switch controls the electrical system.

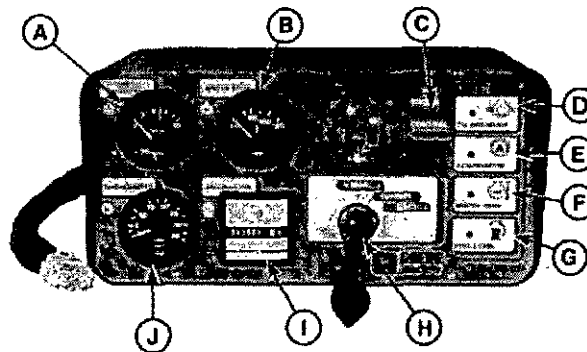

AEZ Instrument Panel

- A—Oil Pressure Gauge
- B—Coolant Temperature Gauge
- C—Engine Control Light
- D—Oil Pressure Light
- E—Alternator Light
- F—Coolant Temperature Light
- G—Fuel Level Light
- H—Key Switch
- I—Hour Meter
- J—Tachometer

RG11590 -JUN-08DEC00

Engine Operating Guidelines

I—Hour Meter - Indicates the operating hours of the engine while key switch is in the "ON" position. The hour meter should be used as a guide for scheduling periodic service.

J—Tachometer - Indicates engine speed in revolutions per minute (rpm).

Continued on next page

QUOD002,0000028 -19-18JAN01-4/6

VDO Instrument (Gauge) Panel (Except North America)

A—Oil Pressure Gauge - The oil pressure gauge indicates engine oil pressure.

B—Coolant Temperature Gauge - The coolant temperature gauge indicates coolant temperature.

C—Tachometer - The tachometer indicates engine speed in hundreds of revolutions per minute (rpm).

The engine control system consists of the following:

D—Engine Control Light - The engine control light illuminates after the engine has started and oil pressure is up to specification. The light indicates that the engine protection circuitry is activated.

E—Preheater Light - The preheater light illuminates when the key is turned to the bulb test position (position I). It should go off after approximately five seconds. When the key switch is held in position II, the engine preheater is energized and the preheater light illuminates.

F—Fuel Level Light - The fuel level light illuminates when the key is turned to the bulb test position (position I). It should go off after approximately five seconds. After the engine is running, if the engine runs out of fuel, the light will illuminate. The fuel level light will remain on indicating the engine was stopped due to the fuel tank being empty.

G—Battery Light - The battery light illuminates when the key is turned to the bulb test position (position I). It should go off after approximately five seconds. After the engine is running, if the alternator stops charging, the light will illuminate and protection circuitry will stop the engine. The battery light will remain on indicating the engine was stopped due to the alternator not charging.

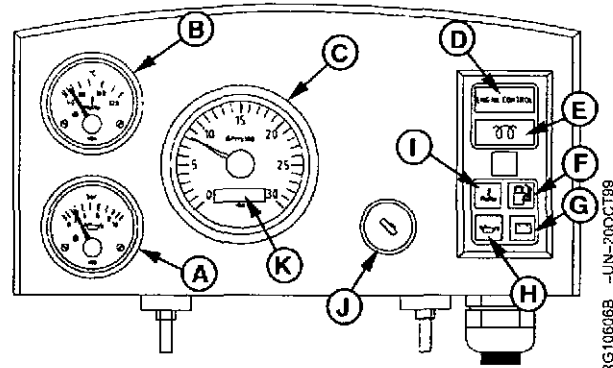

- A—Oil Pressure Gauge
- B—Coolant Temperature Gauge
- C—Tachometer
- D—Engine Control Light
- E—Preheater Light
- F—Fuel Level Light
- G—Battery Light
- H—Oil Pressure Light
- I—Coolant Temperature Light
- J—Key/Start Switch
- K—Hour Meter

Continued on next page

OUOD002.0000028 -19-18JAN01-5/6

H—Oil Pressure Light - The oil pressure light illuminates when the key switch is turned to the bulb test position (position I). The light will remain on until the engine is started and the specified oil pressure is reached. If oil pressure is lost during engine operation, the light will illuminate and protection circuitry will stop the engine. The oil pressure light will remain on, indicating that the engine was stopped due to a low oil pressure condition.

I—Coolant Temperature Light - The coolant temperature light illuminates when the key is turned to the bulb test position (position I). It should go off after approximately five seconds. After the engine is running, if the engine overheats, the light will illuminate and protection circuitry will stop the engine. The coolant temperature light will remain on indicating the engine was stopped due to the engine overheating.

Other components on the instrument panel:

J—Key/Start Switch - The four-position key start switch controls the electrical system.

K—Hour Meter - The hour meter is an integral part of the tachometer. It shows the accumulated hours of engine service. The hour meter operates when the engine is running and accumulated hours are displayed in hours and tenths of hours.

OUOD002,0000028 -19-18JAN01-6/6

NORMAL ENGINE OPERATION

Observe engine coolant temperature and engine oil pressure. Temperatures and pressures will vary between engines and with changing operating conditions, temperatures, and loads.

Normal engine coolant operating temperature range is 82°–94°C (180°–202°F). If coolant temperature rises above 112°C (234°F), reduce load on engine. Unless temperature drops quickly, stop engine and determine cause before resuming operation.

Operate the engine under a lighter load and at slower than normal speed for first 15 minutes after start-up. **DO NOT** run engine at slow idle.

IMPORTANT: Should the engine die while operating under load, immediately

remove load and restart the engine. Overheating of the turbocharger parts may occur when oil flow is stopped.

Stop engine immediately if there are any signs of part failure. Symptoms that may be early signs of engine problems are:

- Sudden drop in oil pressure
- Abnormal coolant temperatures
- Unusual noise or vibration
- Sudden loss of power
- Excessive black exhaust
- Excessive fuel consumption
- Excessive oil consumption
- Fluid leaks

RG, RG34710, 5045 -19-30JAN98-1/1

BREAK-IN SERVICE

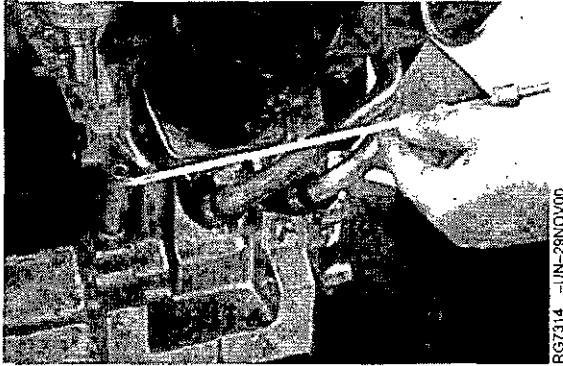

Check Engine Oil Level

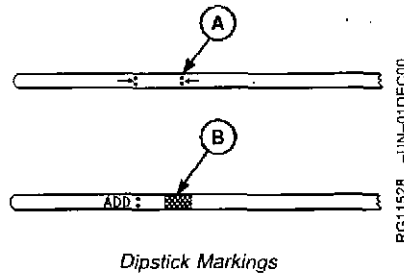

Dipstick Markings

A—Full Mark

B—Crosshatch

The engine is ready for normal operation. However, extra care during the first 100 hours of operation will result in more satisfactory long-term engine performance and life. **DO NOT** exceed 100 hours of operation with break-in oil.

1. This engine is factory-filled with a special break-in oil. Operate the engine at heavy loads with minimal idling during the break-in period.
2. If the engine has significant operating time at idle, constant speeds, and/or light load usage, or make-up oil is required in the first 100 hour period, a longer break-in period may be required. In these situations, an additional 100 hour break-in period is recommended using a new change of John Deere Engine Break-In Oil and new John Deere oil filter.

IMPORTANT: Do not add makeup oil until the level is **BELOW** the **ADD** mark or lower

arrow on dipstick. If make-up oil is required during the break-in period, an additional 100 hour break-in period is required. John Deere Engine Break-In Oil (TY22041) should be used to make up any oil consumed during the break-in period.

DO NOT fill above the top of the mark (A) or crosshatch pattern (B), whichever is present. Oil levels anywhere within arrows or crosshatch are considered in the acceptable operating range.

3. Check engine oil level more frequently. If oil must be added, John Deere Engine Break-In Oil is preferred. See ENGINE BREAK-IN OIL, in Fuels, Lubricants, and Coolant Section.

Continued on next page

RG.RG34710.5046 -19-30JAN98-1Z

IMPORTANT: DO NOT use PLUS-50® Engine Oil or engine oils meeting API CG4, API CF4, ACEA E3, ACEA E2 or CCMC D5 performance levels during the first 100 hours of operation of a new or rebuilt engine. These oils will not allow a new or rebuilt engine to break-in properly.

4. During the first 20 hours, avoid prolonged periods of engine idling or sustained maximum load operation. Vary the engine speed throughout this period. If engine will idle longer than 5 minutes, stop engine.

Specification

Engine ¹ —Oil Pressure at Full Load Rated Speed.....	345 ± 103 kPa (3.45 ± 1.03 bar) (50 ± 15 psi)
Minimum Oil Pressure at Rated Speed.....	275 (2.75 bar) (40 psi)
Minimum Oil Pressure at 850 rpm.....	105 kPa (1.05 bar) (15 psi)
Coolant Temperature Range.....	82°—94°C (180°—202°F)

¹At normal operating temperature of 115 °C (240 °F) sump.

BREAK-IN SERVICE—CONTINUED

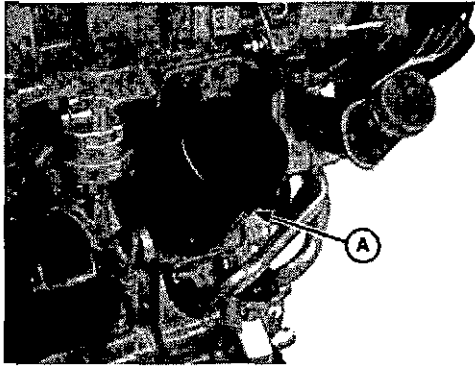

Engine Mounted Oil Filter

RG11529 -UN-01DEC00

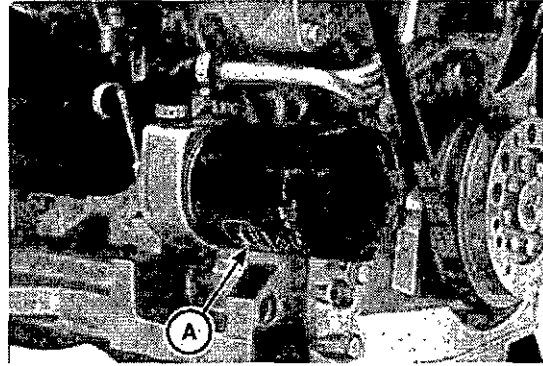

Engine Mounted Oil Filter

RG11530 -UN-01DEC00

5. After the first 100 hours maximum of operation, drain engine oil and change engine oil filter (A). (See CHANGING ENGINE OIL AND REPLACING OIL FILTER in Lubrication and Maintenance/250 Hour Section.) Fill crankcase with seasonal viscosity grade oil. (See DIESEL ENGINE OIL in Fuels, Lubricants, and Coolant Section.)

A—Oil Filter

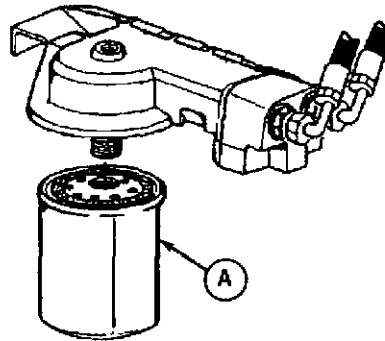

3029 Engines with Remote Oil Filter

RG11549 -UN-06DEC00

Continued on next page

OUCD002,000001C -19-01DEC00-1/2

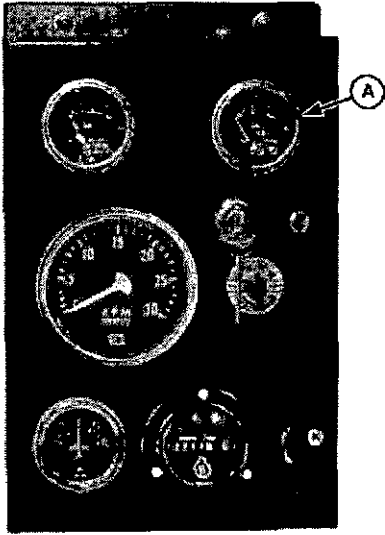

North American Instrument Panel

RG11531 -UN-01DEC00

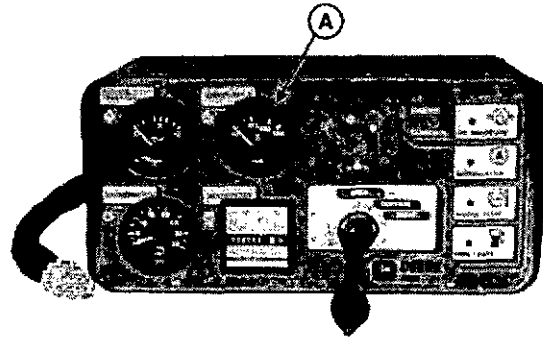

AEZ Instrument Panel (Except North America)

RG11591 -UN-08DEC00

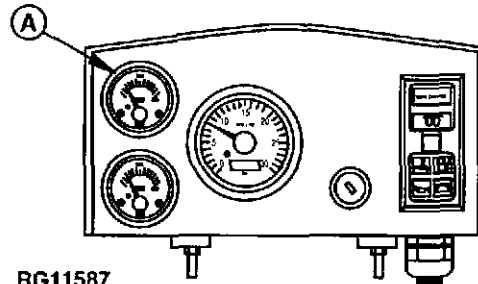

RG11587

VDO Instrument Panel (Except North America)

RG11587 -UN-07DEC00

A—Coolant Temperature Gauge

NOTE: If the engine has significant operating time at idle, constant speeds, and/or light load usage, or makeup oil is required in the first 100 hour period, a longer break-in period may be required. In these situations, an additional 100 hour break-in period is recommended using a new change of John Deere Engine Break-In Oil and new John Deere oil filter.

6. Watch coolant temperature gauge (A) closely. If coolant temperature rises above 112°C (234°F), reduce load on engine. Unless temperature drops quickly, stop the engine and determine the cause before resuming operation.

NOTE: When the coolant temperature gauge reads approximately 115°C (239°F), the engine will shutdown automatically, if equipped with safety controls.

7. The tension on newly installed belts should be checked daily for the first few days of operation because of the initial stretching. Also, check belts for proper seating in pulley grooves.

AUXILIARY GEAR DRIVE LIMITATIONS

IMPORTANT: When attaching an air compressor, hydraulic pump, or other accessory to be driven by the auxiliary gear drive (engine timing gear train at front of engine), power requirements of the accessory must be limited to values listed below:

Power Levels For Right-Hand Auxiliary Gear Drive:

- 16 kW (22 hp) Continuous Operation¹
- 28 kW (37.5 hp) Intermittent Operation¹

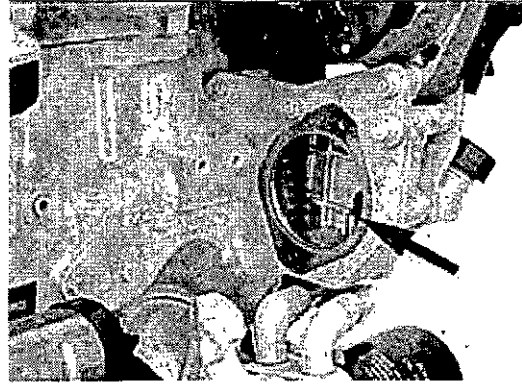

Auxiliary Gear Drive

CD30354 -JUN-03FEB93

¹At 2400 engine rpm.

RG, RG34710, 5047 -19-30JAN98-1/1

GENERATOR SET (STANDBY) APPLICATIONS

To assure that your engine will deliver efficient standby operation when needed, start engine and run at rated speed (with 50%—70% load) for 30 minutes every 2 weeks. DO NOT allow engine to run extended period of time with no load.

RG, RG34710, 5048 -19-30JAN98-1/1

STARTING THE ENGINE

The following instructions apply to the optional controls and instruments available through the John Deere Parts Distribution Network. The controls and instruments for your engine may be different from those shown here; always follow manufacturer's instructions.

Continued on next page

RG, RG34710, 5049 -19-30JAN98-1/4

CAUTION: Before starting engine in a confined building, install proper outlet exhaust ventilation equipment. Always use safety approved fuel storage and piping.

NOTE: If temperature is below 0 °C (32 °F), it may be necessary to use cold weather starting aids (See COLD WEATHER OPERATION, later in this section).

1. Perform all prestarting checks outlined in Lubrication & Maintenance/Daily Section later in this manual.
2. Open the fuel supply shut-off valve, if equipped.

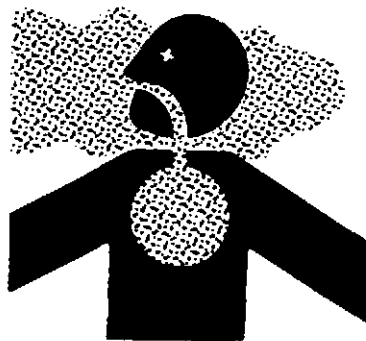

Avoid Toxic Fumes

TS220 -UN-23AUG68

RG.RG34710,5049 -19-30JAN98-2/4

3. If equipped with PTO clutch, pull lever (arrow) rearward (away from engine) to disengage PTO clutch.

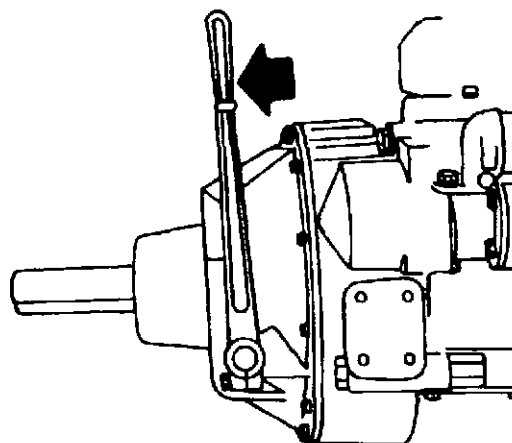

PTO Clutch Lever

RG5602 -UN-16JUN00

Continued on next page

RG.RG34710,5049 -19-30JAN98-3/4

4. Pull hand throttle (A) 1/3 of the way out. Turn the handle in either direction to lock it in place.
5. If equipped, depress and hold reset button (B) while starting.

IMPORTANT: Do not operate the starter for more than 30 seconds at a time. To do so may overheat the starter. If the engine does not start the first time, wait at least 2 minutes before trying again. If engine does not start after four attempts, see Troubleshooting Section.

6. Turn the key switch (C) clockwise to crank the engine. When the engine starts, release the key so that it returns to the "ON" position.

IMPORTANT: If the key switch is released before the engine starts, wait until the starter and the engine stop turning before trying again. This will prevent possible damage to the starter and/or flywheel.

7. After the engine starts, continue to hold the reset button in until the oil pressure gauge (D) reads at least 105 kPa (1.05 bar) (15 psi). The safety controls will not allow the engine to run at a lower oil pressure unless the reset button is held in.

IMPORTANT: Should the engine die while operating under load, immediately disengage PTO clutch and restart the engine. Overheating of turbocharger parts may occur when oil flow is stopped.

8. Check all gauges for normal engine operation. If operation is not normal, stop the engine and determine the cause.

- A—Hand Throttle
- B—Reset Button
- C—Key Switch
- D—Oil Pressure Gauge

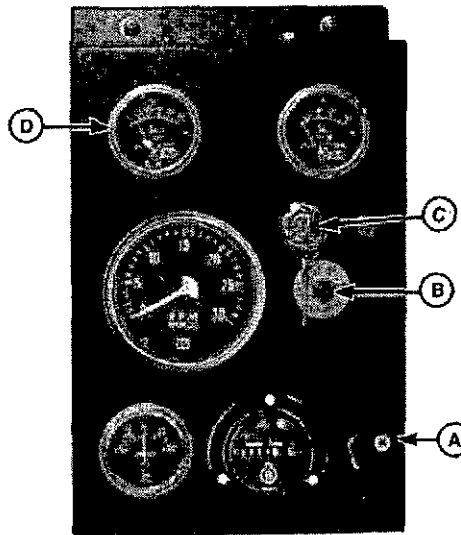

RG11532 -UN-01DEC00

North American Instrument Panel

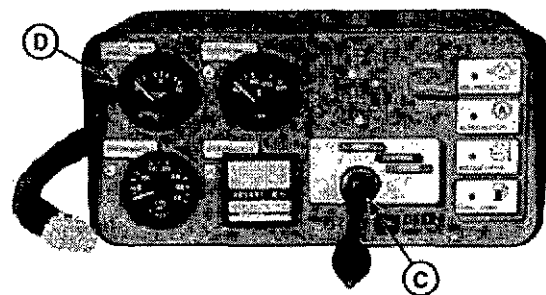

RG11592 -UN-17JAN01

AEZ Instrument Panel (Except North America)

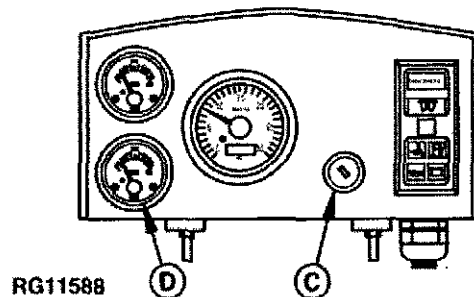

RG11588

RG11588 -UN-08DEC00

VDO Instrument Panel (Except North America)

COLD WEATHER OPERATION

CAUTION: Ether injector starting fluid is highly flammable. **DO NOT** use starting fluid on engines equipped with air intake heaters.

DO NOT use starting fluid near fire, sparks, or flames. **DO NOT** incinerate or puncture a starting fluid container.

Engines may be equipped with intake air heaters, coolant heaters, or ether injectors as a cold weather starting aid.

Starting aids are required below 32°F (0°C). They will enhance starting performance above these temperatures and may be needed to start applications that have high parasitic loads during cranking and/or start acceleration to idle.

Using correct grade of oil (per engine and machine operator's manual) is critical to achieving adequate cold weather cranking speed.

Other cold weather starting aids are required at temperatures below -22°F (-30°C) or at altitudes above 1500 m (5000 ft).

1. Follow steps 1—4 as listed under "STARTING THE ENGINE", then proceed as follows according to the instrument (control) panel on your engine.
2. Switch on the air intake heater for 30 seconds or activate ether injector by following suppliers instructions.
3. Follow remaining steps 5—8 as listed under "STARTING THE ENGINE" earlier in this section.

Additional information on cold weather operation is available from your authorized servicing dealer.



Handle Starting Fluid with Care

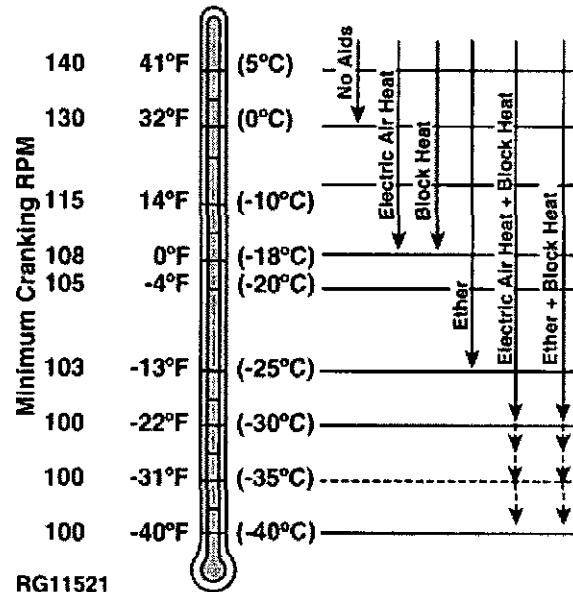

Cold Weather Starting Guidelines

TS1356 -UN-18MAR92

RG11521 -19-10JAN01

RG.RG34710_5050 -19-30JAN98-1/1

WARMING ENGINE

IMPORTANT: To assure proper lubrication, operate engine at or below 1200 rpm with no load for 1–2 minutes. Extend this period 2–4 minutes when operating at temperatures below freezing.

Engines used in generator set applications where the governor is locked at a specified speed may not have a slow idle function. Operate these engines at high idle for 1 to 2 minutes before applying the load. This procedure does not apply to standby generator sets where the engine is loaded immediately upon reaching rated speed.

1. Check oil pressure gauge (A) as soon as engine starts. If gauge needle does not rise above minimum oil pressure specification of 105 kPa (1.05 bar) (15.0 psi) within 5 seconds, stop the engine and determine the cause. Normal engine oil pressure is 345 ± 103 kPa (3.45 bar \pm 1.03 bar) (50 \pm 15 psi) at rated full load speed (1800–2500 rpm) with oil at normal operating temperature of 105°C (221°F).
2. Watch coolant temperature gauge (B). Do not place engine under full load until it is properly warmed up. The normal engine coolant temperature range is 82°–94°C (180°–202°F).

NOTE: It is a good practice to operate the engine under a lighter load and at lower speeds than normal for the first few minutes after start-up.

- A—Oil Pressure Gauge
- B—Coolant Temperature Gauge

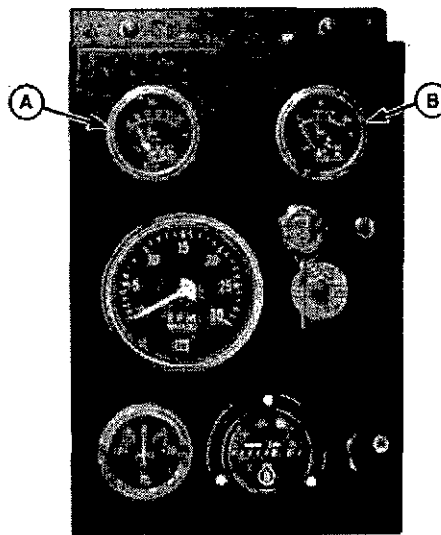

RG11533 -UN-01DEC00

North American Instrument Panel

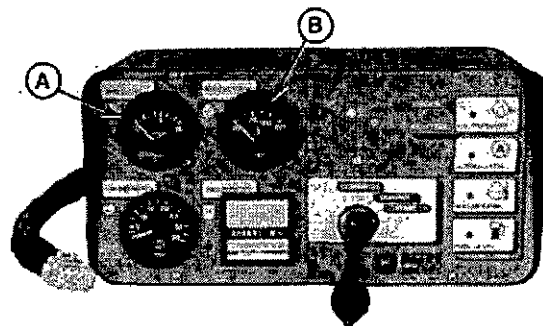

RG11583 -UN-08DEC00

AEZ Instrument Panel (Except North America)

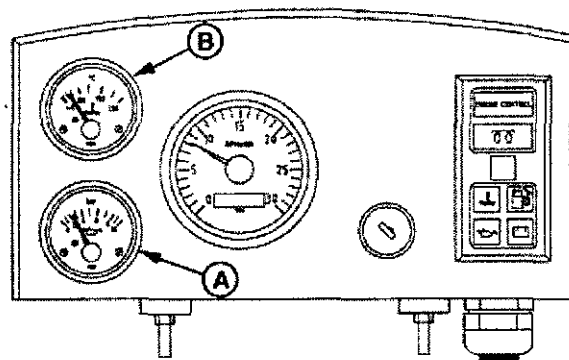

RG10613 -UN-21OCT98

VDO Instrument Panel (Except North America)

RG.RG34710.5051 -19-30JAN98-1/1

CHANGING ENGINE SPEED-STANDARD (MECHANICAL) GOVERNOR

NOTE: Throttle levers are usually supplied by OEM manufacturer. Consult supplier literature to familiarize yourself with throttle lever used on your engine.

To increase engine speed, turn throttle handle (A) to the horizontal position and pull out until desired engine speed is obtained. Turn the handle in either direction to lock throttle position. The handle is pushed inward to decrease engine speed.

A—Throttle Handle

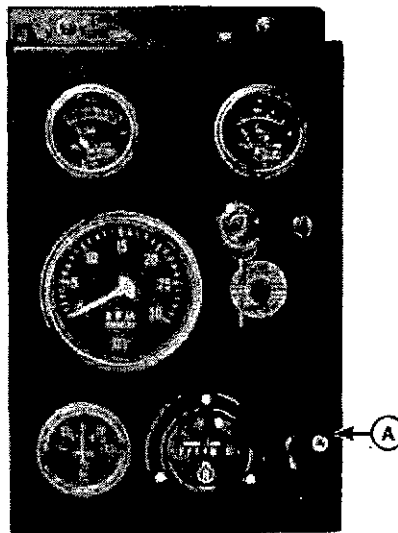

RG11534 -JUN-01DEC00

Throttle Handle on North American Instrument Panel

RG, RG34710, 5052 -19-30JAN98-1/1

IDLING ENGINE

Avoid excessive engine idling. Prolonged idling may cause the engine coolant temperature to fall below its normal range. This, in turn, causes crankcase oil dilution, due to incomplete fuel combustion, and permits formation of gummy deposits on valves, pistons, and piston rings. It also promotes rapid accumulation of engine sludge and unburned fuel in the exhaust system.

Once an engine is warmed to normal operating temperatures, engine should be idled at slow idle

speed. Slow idle speed for this engine is 850 rpm at factory. If an engine will be idling for more than 5 minutes, stop and restart later.

NOTE: Generator set applications where the governor is locked at a specified speed may not have a slow idle function. These engines will idle at no load governed speed (high idle).

RG, RG34710, 5053 -19-30JAN98-1/1

STOPPING THE ENGINE

1. Pull PTO clutch lever (arrow) rearward (away from engine) to disengage clutch, if equipped.

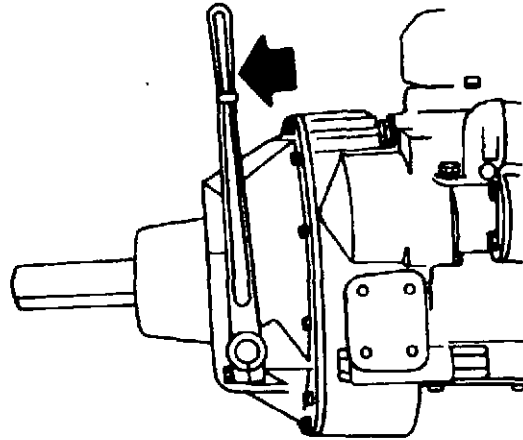

PTO Clutch Lever

RG5602 -UN-16JUN00

Continued on next page

RG.RG34710,5054 -19-30JAN98-1/2

2. Move the throttle handle (A) to slow idle on standard (mechanical) governor engines.

IMPORTANT: Before stopping an engine that has been operating at working load, idle engine at least 2 minutes at 1000–1200 rpm to cool hot engine parts.

Engines in generator set applications, where the governor is locked at a specified speed and no slow idle function is available, run engine for at least 2 minutes at fast idle and no load.

3. Turn key switch to "OFF" position. Remove ignition key.

IMPORTANT: Make sure that exhaust stack cap (rain cap) is installed when engine is not running. This will prevent water and dirt from entering engine.

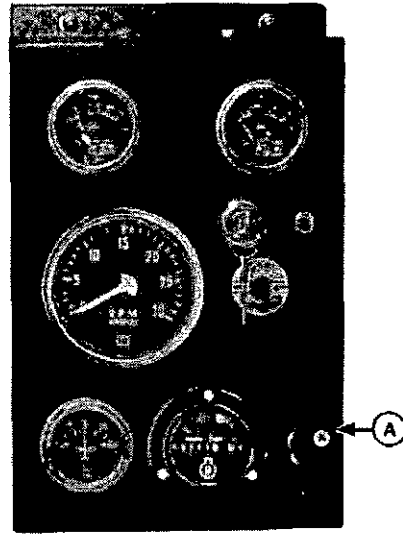

RG11534 -UN-01DEC00

A—Throttle Handle

Throttle Handle on North American Instrument Panel

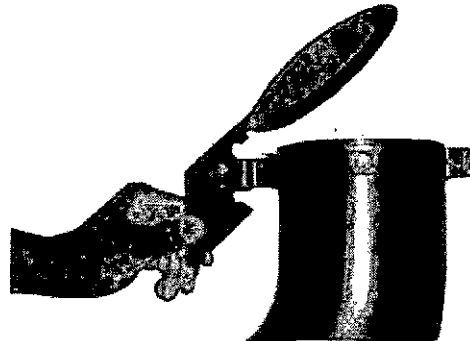

RG10616 -UN-16JUN00

Rain Cap

RG.RG34710.5054 -19-30JAN98-2/2

USING A BOOSTER BATTERY OR CHARGER

CAUTION: Gas given off by battery is explosive. Keep sparks and flames away from battery. Before connecting or disconnecting a battery charger, turn charger off. Make last connection and first disconnection at a point away from battery. Always connect **NEGATIVE (-)** cable last and disconnect this cable first.

IMPORTANT: Be sure polarity is correct before making connections. Reversed polarity will damage electrical system. Always connect positive to positive and negative to ground. Always use 12-volt booster battery for 12-volt electrical systems and 24-volt booster battery(ies) for 24-volt electrical systems.

WARNING: Battery posts, terminals, and related accessories contain lead and lead compounds, chemicals known to the State of California to cause cancer and reproductive harm. **Wash hands after handling.**

A 12-volt booster battery can be connected in parallel with battery(ies) on the unit to aid in cold weather starting. ALWAYS use heavy duty jumper cables.

1. Connect booster battery or batteries to produce the required system voltage for your engine application.

NOTE: To avoid sparks, **DO NOT** allow the free ends of jumper cables to touch the engine.

2. Connect one end of jumper cable to the **POSITIVE (+)** post of the booster battery.
3. Connect the other end of the jumper cable to the **POSITIVE (+)** post of battery connected to starter.
4. Connect one end of the other jumper cable to the **NEGATIVE (-)** post of the booster battery.
5. **ALWAYS** complete the hook-up by making the last connection of the **NEGATIVE (-)** cable to a good ground on the engine frame and away from the battery(ies).

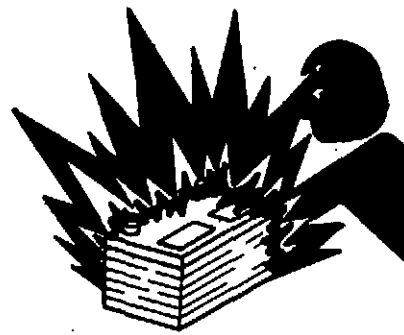

Exploding Battery

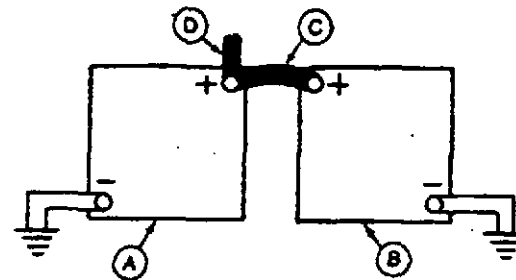

12-Volt System

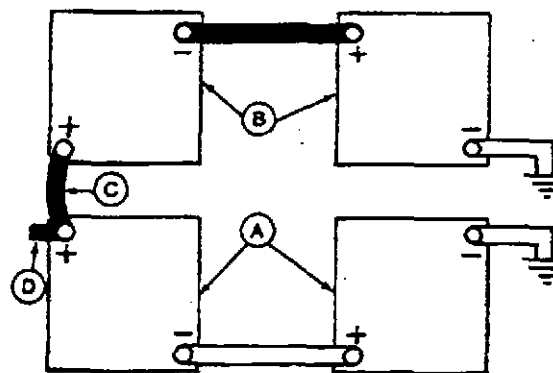

24-Volt System

- A—12-Volt Machine Battery (ies)
- B—12-Volt Booster Battery (ies)
- C—Booster Cable
- D—Cable to Starting Motor

TS204 -UN-23AUG88

RG4678 -UN-14DEC88

RG4698 -UN-14DEC88

Continued on next page

RG.RG34710,4060 -19-01JAN96-1/2

Engine Operating Guidelines

6. Start the engine. Disconnect jumper cables immediately after engine starts. Always disconnect NEGATIVE (-) cable first.

RG, RG34710, 4060 -19-01 JAN96-2/2

Lubrication and Maintenance

OBSERVE SERVICE INTERVALS

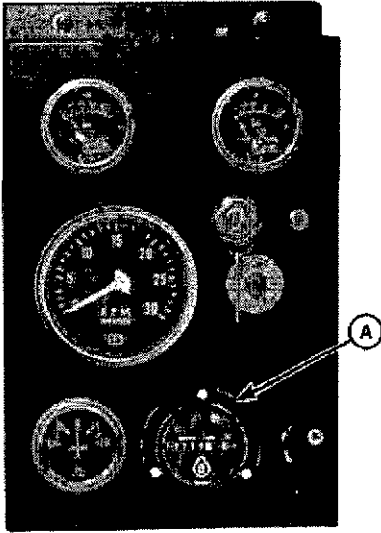

North American Instrument Panel Hour Meter

RG11589 -UN-08DEC00

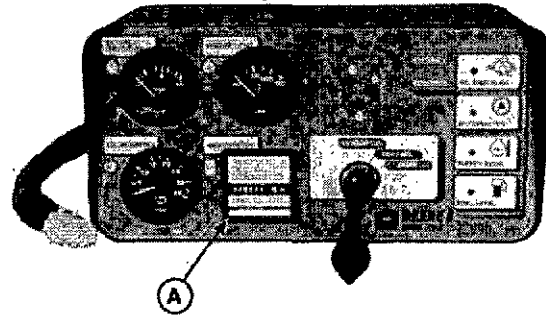

AEZ Instrument Panel Hour Meter

RG11594 -UN-08DEC00

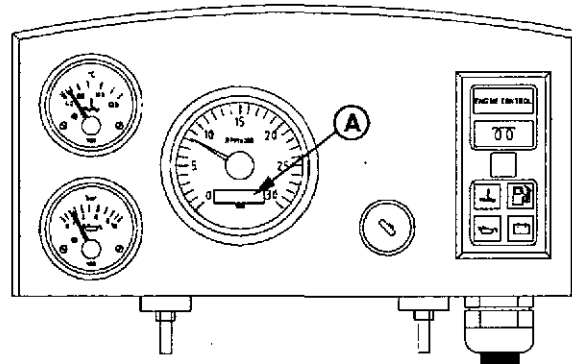

VDO Instrument Panel Hour Meter

RG10516 -UN-21OCT99

A—Hour Meter

Using hour meter (A) as a guide, perform all services at the hourly intervals indicated on following pages. At each scheduled maintenance interval, perform all previous maintenance operations in addition to the ones specified. Keep a record of hourly intervals and services performed using charts provided in Lubrication and Maintenance Records Section.

IMPORTANT: Recommended service intervals are for normal operating conditions. Service **MORE OFTEN** if engine is operated under adverse conditions. Neglecting maintenance can result in failures or permanent damage to the engine.

RG, RG34710, 5056 -19-30JAN98-1/1

USE CORRECT FUELS, LUBRICANTS, AND COOLANT

IMPORTANT: Use only fuels, lubricants, and coolants meeting specifications outlined in Fuels, Lubricants, and Coolant Section when servicing your John Deere Engine.

Consult your John Deere Servicing Distributor or your nearest John Deere Parts Network for recommended fuels, lubricants, and coolant. Also available are necessary additives for use when operating engines in tropical, arctic, or any other adverse conditions.

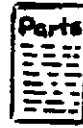

John Deere Parts

TS1100 -UN-23AUG88

RG, RG34710, 5057 -19-30JAN98-1/1

**LUBRICATION AND MAINTENANCE SERVICE
INTERVAL CHART—PRIME POWER
ENGINES**

Item	Lubrication and Maintenance Service Intervals					
	Daily	250 Hour or 6 Month	400 Hour	600 Hour or 12 Month	1200 Hour or 24 Month	As Required
Check Engine Oil and Coolant Level	•					
Lubricate PTO Release Bearing	•					
Check Air Cleaner Dust Unloader Valve & Restriction Indicator ^a	•					
Visual Walk Around Inspection	•					
Check Fuel Filter	•					
Service Fire Extinguisher		•				
Lubricate PTO Clutch Shaft Bearing		•				
Service Battery		•				
Change Engine Oil and Filter ^b		•				
Check Fan and Alternator Belt Tension		•				
Check PTO Clutch Adjustment		•				
Check Engine Mounts		•				
Initial Valve Clearance Adjustment ^c			•			
Check Engine Ground Connection				•		
Lubricate PTO Clutch Levers and Linkage				•		
Clean Crankcase Vent Tube				•		
Check Air Intake Hoses, Connections, and System				•		
Replace Fuel Filter Element				•		
Check Cooling System				•		
Coolant Solution Analysis-Add SCAs as needed				•		
Pressure Test Cooling System				•		
Check and Adjust Valve Clearance					•	
Flush and Refill Cooling System ^d					•	
Test Thermostats					•	
Add Coolant						•

^aReplace primary air cleaner element when restriction indicator shows a vacuum of 625 mm (25 in.) H₂O.

^bChange the oil and filter for the first time after 100 hours maximum of operation, then every 250 hours thereafter. If PLUS-50 oil is used along with a John Deere oil filter, the oil change interval may be extended by 50 percent to 375 hours.

^cHave your authorized servicing dealer or engine distributor adjust valve clearance after the first 400 hours of operation. Then, have the valve clearance adjusted at 1200 Hour/24 Month intervals thereafter.

^dIf John Deere COOL-GARD is used, the flushing and refilling interval may be extended to 3000 hours or 36 months. If John Deere COOL-GARD is used and the coolant is tested annually AND additives are replenished by adding supplemental coolant additives (SCAs), the flushing and refilling interval may be extended to 5000 hours or 60 months, whichever occurs first.

Lubrication and Maintenance

Item	Lubrication and Maintenance Service Intervals					
	Daily	250 Hour or 6 Month	400 Hour	600 Hour or 12 Month	1200 Hour or 24 Month	As Required
Bleed Fuel System						•
Replace Air Cleaner Elements						•
Replace Belts						•
Inspect PTO Clutch						•
Check Fuses						•

RG, RG34710, 5058 -19-30JAN98-2/2

LUBRICANT AND MAINTENANCE SERVICE INTERVAL CHART—GENERATOR (STANDBY) APPLICATIONS

NOTE: The service intervals in the Lubrication and Maintenance Sections that follow reflect standard engines. Use service intervals listed below for generator (standby) applications. Match service items below to titles in Lubrication and Maintenance Sections for procedures.

Item	Lubrication and Maintenance Service Intervals					
	Every 2 Weeks	250 Hours or 6 Month	400 Hour	600 Hour or 12 Months	1200 Hour or 24 Months	As Required
Operate Engine at Rated Speed and 50%-70% Load a Minimum of 30 Minutes	•					
Check Engine Oil and Coolant Level	•					
Check Fuel Filter	•					
Lubricate PTO Release Bearings	•					
Check Air Cleaner Dust Unloader Valve & Restriction Indicator Gauge ^a	•					
Visual Walkaround Inspection	•					
Service Fire Extinguisher		•				
Lubricate PTO Clutch Shaft Bearings		•				
Service Battery		•				
Change Engine Oil and Replace Oil Filter ^b		•				
Check Fan and Alternator Belt Tension		•				
Check PTO Clutch Adjustment		•				
Check Engine Mounts		•				
Initial Valve Clearance Adjustment ^c			•			
Check Engine Ground Connection				•		
Clean Crankcase Vent Tube				•		
Check Air Intake Hoses, Connections & System				•		
Replace Fuel Filter Element				•		
Check Cooling System				•		
Coolant Solution Analysis-Add SCAs as required				•		

^aReplace primary air cleaner element when restriction indicator shows a vacuum of 625 mm (25 in.) H₂O.

^bChange the oil for the first time before 100 hours maximum of (break-in) operation, then every 250 hours thereafter. If PLUS-50 oil is used along with a John Deere oil filter, the oil change interval may be extended by 50 percent to 375 hours.

^cHave your authorized servicing dealer or engine distributor adjust valve clearance after the first 400 hours of operation. Then, have the valve clearance adjusted at 1200 Hour/24 Month intervals thereafter.

Lubrication and Maintenance

Item	Lubrication and Maintenance Service Intervals					
	Every 2 Weeks	250 Hours or 6 Month	400 Hour	600 Hour or 12 Months	1200 Hour or 24 Months	As Required
Pressure Test Cooling System				•		
Check and Adjust Valve Clearance					•	
Adjust Variable Speed					•	
Flush and Refill Cooling System ^d					•	
Test Thermostats					•	
Add Coolant						•
Bleed Fuel System						•
Replace Air Cleaner Elements						•
Replace Belts						•
Check Fuses						•

^dIf John Deere COOL-GARD is used, the flushing and refilling interval may be extended to 3000 hours or 36 months. If John Deere COOL-GARD is used and the coolant is tested annually AND additives are replenished by adding supplemental coolant additives, the flushing and refilling interval may be extended to 5000 hours or 60 months, whichever occurs first.

OUOD002,0030022 -19-06DEC00-2/2

Lubrication & Maintenance/Daily

DAILY PRESTARTING CHECKS

Do the following BEFORE STARTING THE ENGINE for the first time each day:

Check Engine Oil Level

IMPORTANT: There is no need to add makeup oil until the oil level is **BELOW** the add mark.

DO NOT fill above the top mark on the dipstick. Oil levels anywhere within arrows (C) or crosshatch (D), whichever is present, are considered in the acceptable operating range.

1. Check engine oil level on dipstick (A). Oil level on dipstick should be within arrows (C) or crosshatch (D). Add oil at filler cap (B) as required, using seasonal viscosity grade oil. (See DIESEL ENGINE OIL in Fuels, Lubricants, and Coolant Section for oil specifications.)

Some engines may have the oil filler cap on rocker arm cover, while others will have the filler cap on the timing gear cover.

- A—Dipstick
- B—Oil Filler Cap
- C—Arrows
- D—Crosshatch

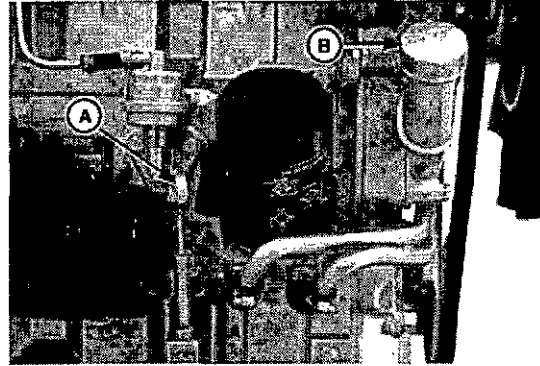

3029D Engines

RG11536 -UN-01DEC00

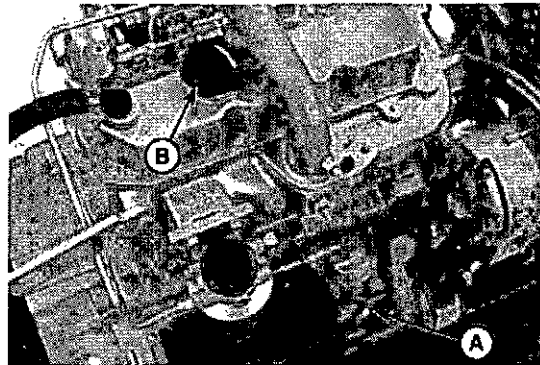

3029T Engines

RG11537 -UN-01DEC00

RG11595 -UN-08DEC00

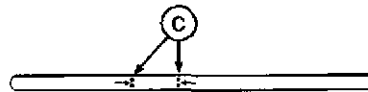

Correct Oil Level Within Arrows

RG11538 -UN-01DEC00

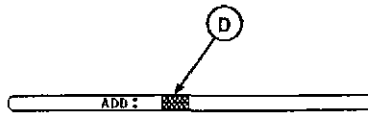

Correct Oil Level Within Crosshatch

Continued on next page

RG.RG34710.5059 -19-30JAN98-1/5

Check Coolant Level

CAUTION: Explosive release of fluids from pressurized cooling system can cause serious burns.

Only remove filler cap when engine is cold or when cool enough to touch with bare hands. Slowly loosen cap to first stop to relieve pressure before removing completely.

1. Check the coolant level when engine is cold. Coolant level should be at bottom of filler neck. Fill radiator (A) with proper coolant solution if level is low. (See ADDING COOLANT in Service As Required Section.) Check overall cooling system for leaks.

Refer to your vehicle's operator's manual for recommendations for non-John Deere supplied accessories.

A—Radiator

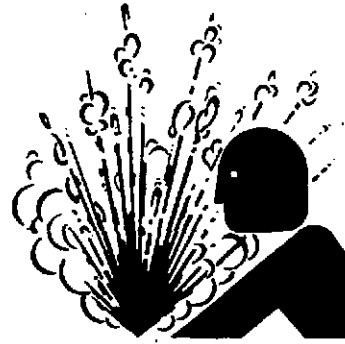

Beware of Hot Fluids Under Pressure

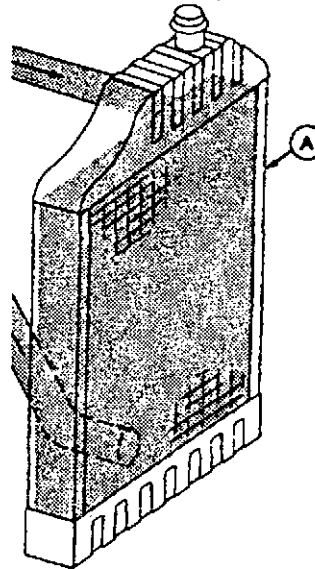

Coolant Level in Radiator

TS281 -JUN-23AUG88

RG4675 -JUN-14DEC88

Continued on next page

RG.RG34710.5059 -19-30JAN98-2/5

Lubricate PTO Bearing

1. Apply one shot of John Deere Multi-Purpose Lubricant or equivalent at PTO release bearing grease fitting (A). DO NOT over lubricate.

A—Grease Fitting

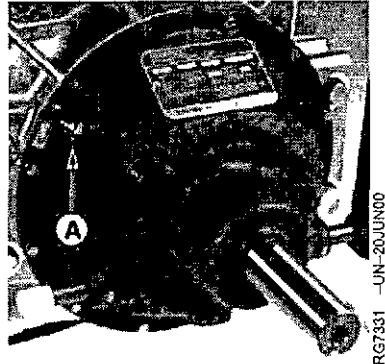

PTO Release Bearing

Continued on next page

RG, RG34710, 5059 -19-30JAN98-3/5

Check Air Cleaner

IMPORTANT: Maximum air intake restriction is 3.5 kPa (0.03 bar) (0.5 psi) (14 in.) H₂O. A clogged air cleaner element will cause excessive intake restriction and a reduced air supply to the engine.

1. Squeeze dust unloader valve (A) on air cleaner assembly to remove dust deposits. If clogged, remove and clean the dust unloader valve. Replace if damaged.

IMPORTANT: Do not operate engine without the dust unloader valve.

If equipped with air intake restriction indicator gauge (B), check gauge. Service air cleaner when indicator is red.

Inspect Engine Compartment

1. Make a thorough inspection of the engine compartment. Look for oil or coolant leaks, worn fan and accessory drive belts, loose connections and trash build-up. Remove trash build-up and have repairs made as needed if leaks are found.

NOTE: Wipe all fittings, caps, and plugs before performing any maintenance to reduce the chance of system contamination.

Inspect:

- Radiator for leaks and trash build-up.
- Air intake system hoses and connections for cracks and loose clamps.
- Fan, alternator, and accessory drive belts for cracks, breaks or other damage.
- Water pump for coolant leaks.

NOTE: It is normal for a small amount of leakage to occur as the engine cools down and parts contract. Excessive coolant leakage may indicate the need to replace the water pump seal. Contact your engine distributor or servicing dealer for repairs.

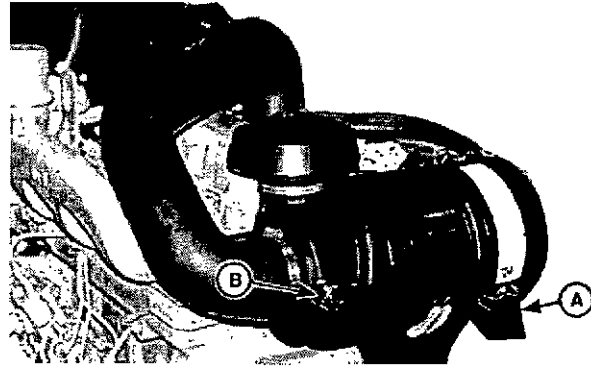

European Air Cleaner

RG11535 -UN-01DEC00

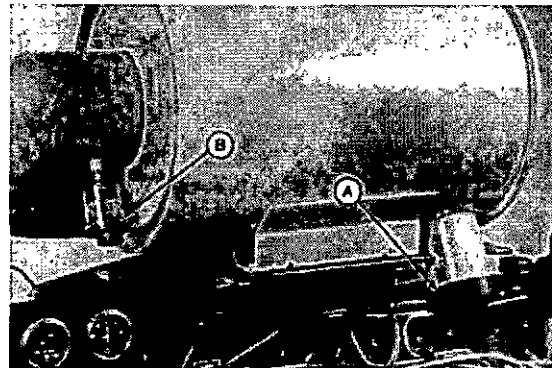

North American Air Cleaner

RG7332 -UN-06JAN99

A—Dust Unloader Valve
B—Restriction Indicator Gauge

Checking Fuel Filter

Check the fuel filter daily for water or debris and drain as necessary.

IMPORTANT: Drain water into a suitable container and dispose of properly.

1. Loosen drain plug (B) at bottom of fuel filter two or three turns.
2. Loosen air bleed plug (A) two full turns on fuel filter base and drain water from bottom until fuel starts to drain out.
3. When fuel starts to drain out, hand tighten drain plug.

After draining water from the fuel filter, the filter must be primed by bleeding all air from the fuel system.

4. Operate primer lever (C) of the fuel supply pump until fuel flow is free from air bubbles.
5. Tighten bleed plug (A) securely by hand. Continue operating hand primer until pumping action is not felt. When finished, pull hand primer outward (away from engine) as far as it will go.

If the fuel system needs further bleeding of air, see **BLEED FUEL SYSTEM** in *Service As Required* Section, later in this manual.

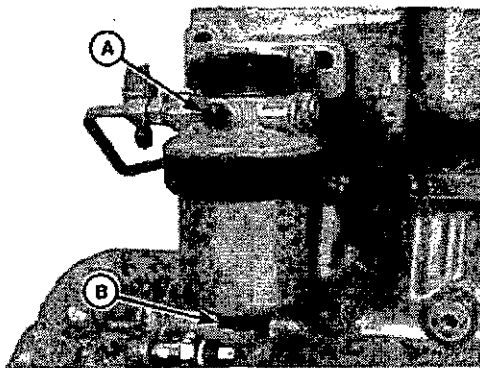

Draining the Fuel Filter

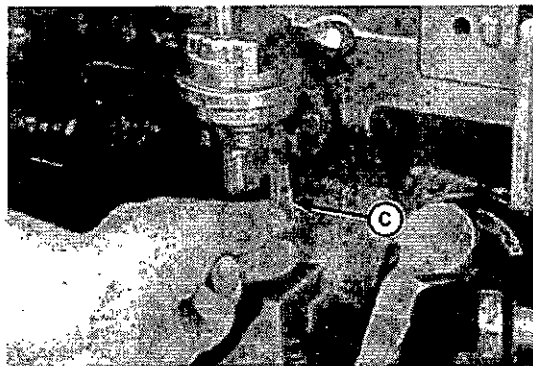

Fuel Supply Pump Primer Lever

- A—Bleed Plug
- B—Drain Plug
- C—Primer Lever

RG, RG34710, 5059 -19-30JAN98-5/5

Lubrication and Maintenance/250 Hour

SERVICING FIRE EXTINGUISHER

A fire extinguisher (A) is available from your authorized servicing dealer or engine distributor.

Read and follow the instructions which are packaged with it. The extinguisher should be inspected at least every 250 hours of engine operation or once a month. Once extinguisher is operated, no matter how long, it must be recharged. Keep record of inspections on the tag which comes with the extinguisher instruction booklet.

A—Fire Extinguisher

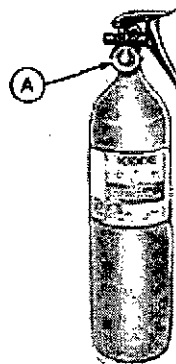

Service Fire Extinguisher

RW4918 -UN-15DEC88

RG, RG34710, 5062 -19-30JAN98-1/1

LUBRICATING PTO CLUTCH SHAFT BEARINGS

Apply one or two shots of John Deere Multipurpose Lubricant or equivalent at clutch drive shaft bearing fitting (B) and pilot bearing fittings (D). DO NOT over-lubricate to avoid getting oil on clutch facings.

NOTE: Location of pilot bearing fitting will depend on application. Only one fitting will be used.

- A—Release Bearing Grease Fitting
- B—Drive Shaft Bearing Fitting
- C—Lever Cross Shaft Fittings
- D—Pilot Bearing Fitting

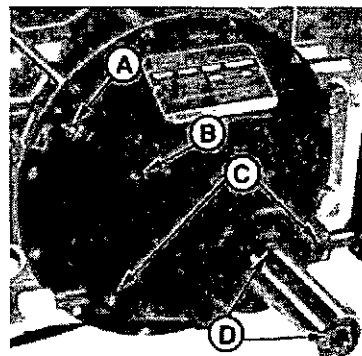

Lubricate PTO Clutch

RG7331C -UN-26JUN00

RG, RG34710, 5061 -19-30JAN98-1/1

SERVICING BATTERY

CAUTION: Battery gas can explode. Keep sparks and flames away from batteries. Use a flashlight to check battery electrolyte level.

Never check battery charge by placing a metal object across the posts. Use a voltmeter or hydrometer.

Always remove grounded **NEGATIVE (-)** battery clamp first and replace it last.



Exploding Battery

TS204 -JUN-23AUG88

WARNING: Battery posts, terminals, and related accessories contain lead and lead compounds, chemicals known to the State of California to cause cancer and reproductive harm. **Wash hands after handling.**

1. On regular batteries, check electrolyte level. Fill each cell to bottom of filler neck with distilled water.

NOTE: *Low-maintenance or maintenance-free batteries should require little additional service. However, electrolyte level can be checked by cutting the center section of decal on dash-line, and removing cell plugs. If necessary, add clean, soft water to bring level to bottom of filler neck.*

2. Keep batteries clean by wiping them with a damp cloth. Keep all connections clean and tight. Remove any corrosion, and wash terminals with a solution of 1 part baking soda and 4 parts water. Tighten all connections securely.

NOTE: *Coat battery terminals and connectors with a mixture of petroleum jelly and baking soda to retard corrosion.*

3. Keep battery fully charged, especially during cold weather. If a battery charger is used, turn charger off before connecting charger to battery(ies). Attach **POSITIVE (+)** battery charger lead to **POSITIVE (+)** battery post. Then attach **NEGATIVE (-)** battery charger lead to a good ground.

HANDLING BATTERIES SAFELY

CAUTION: Battery gas can explode. Keep sparks and flames away from batteries. Use a flashlight to check battery electrolyte level.

Never check battery charge by placing a metal object across the posts. Use a voltmeter or hydrometer.

Always remove grounded (-) battery clamp first and replace it last.

CAUTION: Sulfuric acid in battery electrolyte is poisonous. It is strong enough to burn skin, eat holes in clothing, and cause blindness if splashed into eyes.

Avoid the hazard by:

1. Filling batteries in a well-ventilated area.
2. Wearing eye protection and rubber gloves.
3. Avoiding breathing fumes when electrolyte is added.
4. Avoiding spilling or dripping electrolyte.
5. Use proper jump start procedure.

If you spill acid on yourself:

1. Flush your skin with water.
2. Apply baking soda or lime to help neutralize the acid.
3. Flush your eyes with water for 15–30 minutes. Get medical attention immediately.

If acid is swallowed:

1. Do not induce vomiting.
2. Drink large amounts of water or milk, but do not exceed 2 L (2 quarts).
3. Get medical attention immediately.

WARNING: Battery posts, terminals, and related accessories contain lead and lead compounds, chemicals known to the State of California to cause cancer and reproductive harm. **Wash hands after handling.**

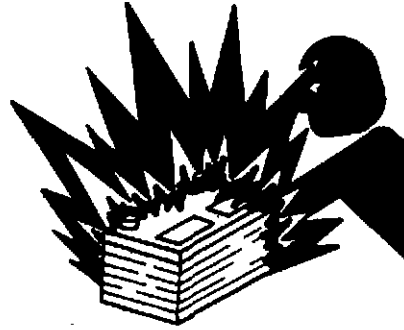

Exploding Battery

TS204 -UN-23AUG88

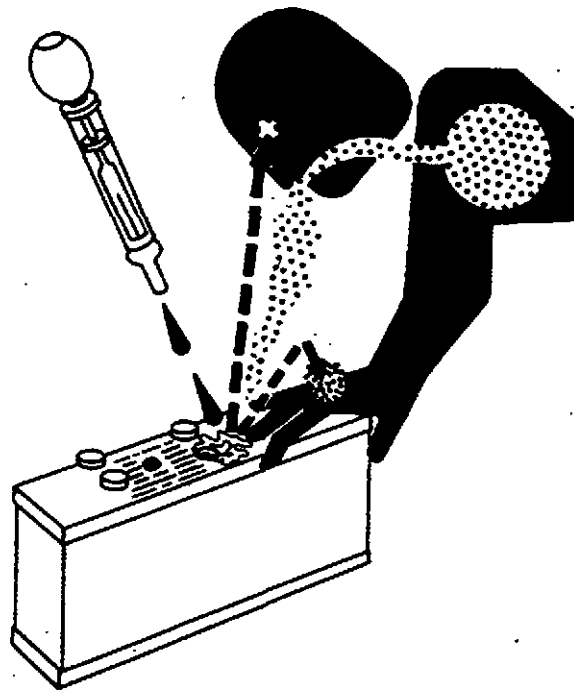

Sulfuric Acid

TS203 -UN-23AUG88

CHANGING ENGINE OIL AND REPLACING OIL FILTER

NOTE: Change engine oil and filter for the first time after 100 hours maximum of operation, then every 250 hours thereafter.

If John Deere PLUS-50 engine oil and a John Deere oil filter are used, the oil and filter change interval may be increased by 50%.

OILSCAN is a John Deere sampling program to help you monitor machine performance and identify potential problems before they cause serious damage. OILSCAN kits are available from your John Deere dealer. Oil samples should be taken prior to the oil change. Refer to instructions provided with kit.

1. Run engine approximately 5 minutes to warm up oil. Shut engine off.
2. Remove oil pan drain plug (arrow).

NOTE: Drain plug location may vary, depending on the application.

3. Drain crankcase oil from engine while warm.

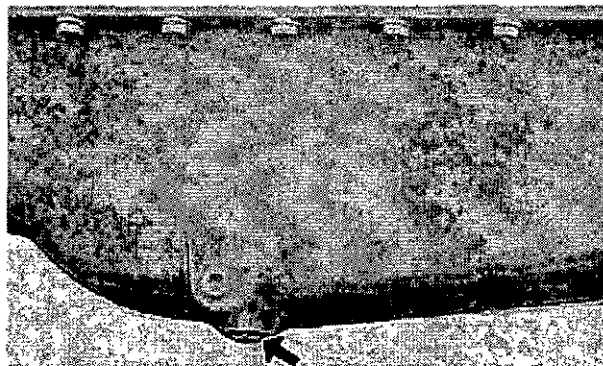

Oil Pan Drain Plug

RG4881 -UN-25NOV88

RG, RG34710, 5064 -19-30JAN98-1/1

4. Remove and discard oil filter (A) using a suitable filter wrench.

NOTE: Depending on engine application, oil filter may be either vertical or horizontal on either engine model.

5. Remove oil filter packing and clean filter mounting pad.

A—Oil Filter

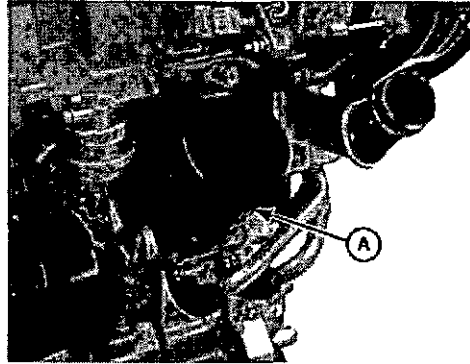

RG11529 -UN-01DEC00

Engine Mounted Oil Filter

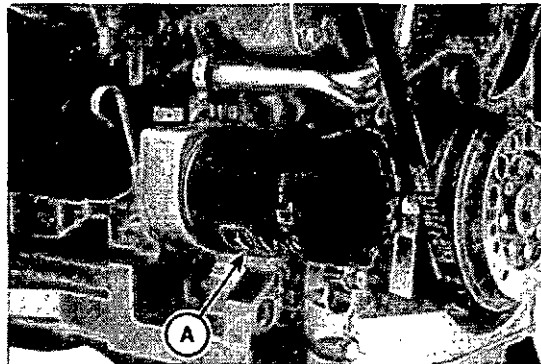

RG11530 -UN-01DEC00

Engine Mounted Oil Filter

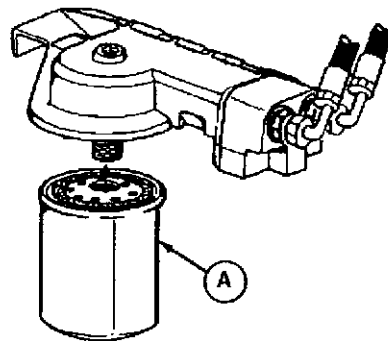

RG11549 -UN-06DEC00

Engines W/Remote Oil Filter

OUOD002,0000023 -19-07DEC00-1/1

6. Oil new packing and install new filter element. Hand tighten element according to values printed on filter element. If values are not provided, tighten element approximately 3/4—1-1/4 turn after packing contacts filter housing. **DO NOT** overtighten filter element.

7. Install oil pan drain plug with a new seal when equipped and tighten using the following specifications.

Conical Plug	55 N·m (41 lb-ft)
Cylindrical Plug W/Copper Washer	70 N·m (52 lb-ft)
Cylindrical Plug W/O-Ring	50 N·m (37 lb-ft)

8. Fill engine crankcase with correct John Deere engine oil through *timing gear cover opening (A)* or *rocker arm cover opening (B)*, depending on engine application. (See **DIESEL ENGINE OIL** in Fuels, Lubricants, and Coolant Section for determining correct engine oil.)

NOTE: Crankcase oil capacity may vary slightly. **ALWAYS** fill crankcase to top arrow or within crosshatch on dipstick, whichever is present. This should be checked after engine has run and oil has drained back into crankcase. **DO NOT** overfill.

To determine the correct oil fill quantity for your engine, see **ENGINE CRANKCASE OIL FILL QUANTITIES** in the Specifications Section.

IMPORTANT: Immediately after completing any oil change, crank engine for 30 seconds without permitting engine to start. This will help insure adequate lubrication to engine components before engine starts.

9. Start engine and run to check for possible leaks.

10. Stop engine and check oil level after 10 minutes. Oil level reading should be between arrows (C) or within crosshatch (D) of dipstick.

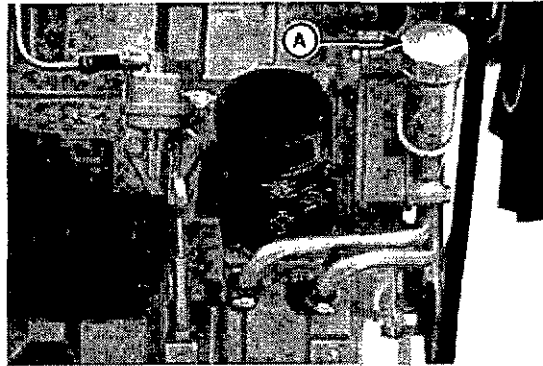

Timing Gear Cover Oil Fill

RG11541 -UN-01DEC00

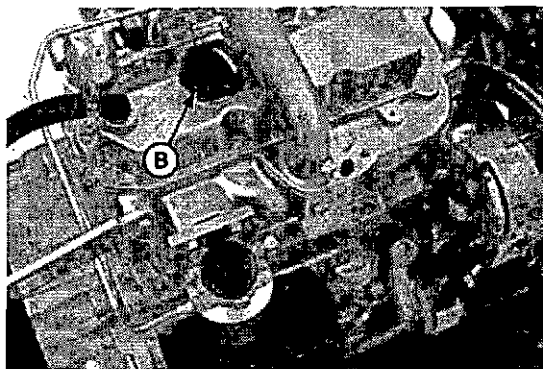

Rocker Arm Cover Oil Fill

RG11537 -UN-01DEC00

RG11596 -UN-08DEC00

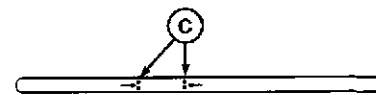

Correct Oil Level Within Arrows

RG11538 -UN-01DEC00

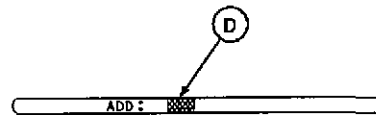

Correct Oil Level Within Crosshatch

- A—Timing Gear Cover Opening
- B—Rocker Arm Cover Opening
- C—Arrows
- D—Crosshatch

CHECKING FAN AND ALTERNATOR V-BELT TENSION

Low belt tension causes slippage resulting in excessive cover wear, burn spots, overheating, or "slip and grab", causing belt breakage.

High belt tension causes belt heating and excessive stretch, as well as damage to drive components such as pulleys and shafts. V-belts should ride on the sides of standard pulleys not on the bottom of the groove.

RG.RG34710,5065 -19-30JAN98-1/3

Standard V-belt tension can be checked with JDG529 Tension Gauge (bold arrow) or equivalent gauge. (Gauge is available from a John Deere Dealer or Distributor)

NOTE: On engines with dual belts, check tension of front belt only.

1. Inspect belts for cracks, fraying, or stretched out areas. Replace if necessary.
2. Using JDG529 Belt Tension Gauge, or belt tension tester (A) and straightedge (B), check tension of warm belts:
 - a. When using JDG529 Belt Tension Gauge, measure belt tension and compare with specifications on next page.
 - b. Belt deflection when using belt tension tester (A) with straightedge (B), with force applied halfway between pulleys.

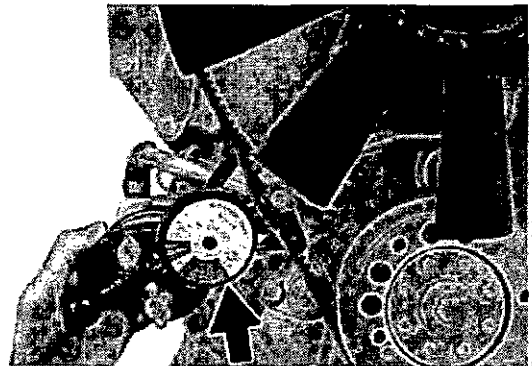

Checking Belt Tension with Tension Gauge

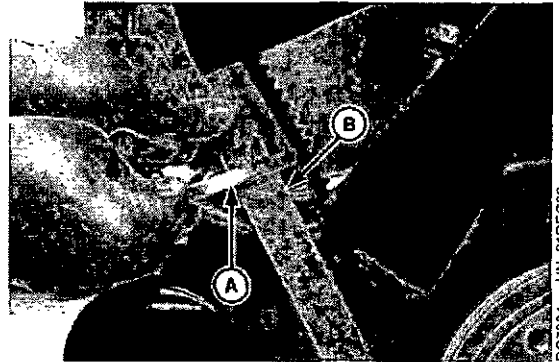

Checking Belt Tension with Straightedge

Specification

Standard V-Belt with 89 N (20 lb)
 force—Deflection 19 mm (3/4 in.)

A—Tension Tester
B—Straightedge

Continued on next page

RG.RG34710,5065 -19-30JAN98-2/3

- If adjustment is necessary, loosen alternator bracket cap screw (C) and nut (D) on mounting bolt. Pull alternator frame outward until belts are correctly tensioned.

IMPORTANT: Do not pry against the alternator rear frame. Do not tighten or loosen belts while they are hot.

- Tighten alternator bracket cap screw and nut firmly.
- After a new or used belt has run for 10 minutes, recheck belt tension.

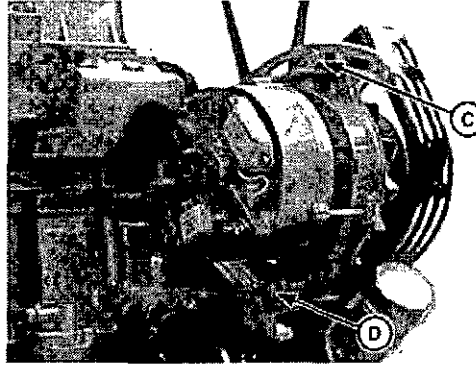

Alternator Mounting Brackets

RG7329 -JUN-01DEC00

STANDARD V-BELTS

	New Belt Tension	Used Belt Tension*
Single Belt	578—623 N (130—140 lb force)	378—423 N (85—95 lb force)
Dual Belts	423—463 N (95—104 lb force)	378—423 N (85—95 lb force)

C—Cap Screw
D—Nut

*Belts are considered used after 10 minutes of operation.

RG.RG34710.5065 -19-30JAN98-3/3

CHECKING PTO CLUTCH ADJUSTMENT

CAUTION: Never attempt to service the PTO while it is in operation. Loose clothing could get caught in moving parts; keep clothing tight against body. Use extreme care when working around the PTO.

1. Measure clutch engagement force at handle grip using a spring scale. The engagement force should be 267–311 N (60–70 lb force).

IMPORTANT: Improper adjustments of the PTO clutch may shorten clutch life. Make sure adjustments are made properly.

2. If adjustments are needed, disengage clutch and stop engine. Remove cover plate from clutch housing (shown removed).
3. Remove adjusting lock (A).
4. Turn adjusting ring (B) to adjust clutch engagement pressure.
5. Measure engagement force at clutch handle with spring scale.
6. Install lock screw and adjusting lock in clutch body splines when specified engagement pressure is achieved.
7. Tighten screw securely.
8. Recheck clutch engagement force with spring scale. Install cover plate. Disengage clutch.



Rotating Driveline

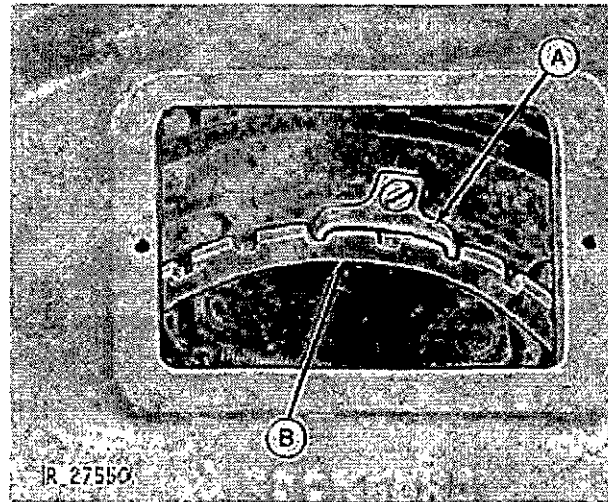

PTO Clutch Adjustment

A—Adjusting Lock
B—Adjusting Ring

TS198 -UN-23AUG88

R27550 -UN-14DEC88

RG.RG34710,4068 -19-01JAN96-1/1

CHECKING ENGINE MOUNTS (GENERATOR SETS)

Engine mounting is the responsibility of the generator manufacturer. Follow manufacturer's guidelines for mounting specifications.

IMPORTANT: Use only Grade SAE 8 or higher grade of hardware for engine mounting.

1. Check the engine mounting brackets (A), vibration isolators, and mounting bolts on support frame and engine block for tightness. Tighten as necessary to recommended torque of generator manufacturer.

2. Inspect overall condition of vibration isolators, if equipped. Replace isolators if rubber has deteriorated or mounts have collapsed, as necessary.

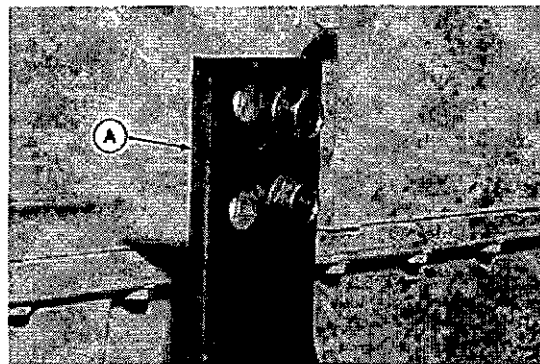

Engine Mounting

A—Engine Mounting Brackets

DPSG,OUOD002,1578 -19-21JUN00-1/1

Lubrication & Maintenance/400 Hour

ADJUSTING ENGINE VALVE CLEARANCE (NEW OR REBUILT ENGINES)

Adjust engine valve clearance after the first 400 hours on new or rebuilt engines. (See CHECKING AND ADJUSTING ENGINE VALVE CLEARANCE in Lubrication and Maintenance/1200 Hour Section or have your authorized servicing dealer or engine distributor adjust the valve clearance.)

IMPORTANT: Have valves adjusted after the first 400 hours of operation on new or rebuilt engines. Then, adjust valves at 1200 hour/24 month intervals thereafter.

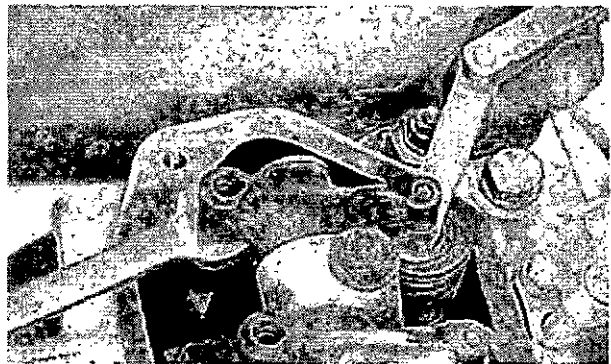

Adjusting Valve Clearance

RG.RG34710,5077 -19-30JAN98-1/1

Lubrication & Maintenance/600 Hour/12 Month

LUBRICATING PTO CLUTCH INTERNAL LEVERS AND LINKAGE

⚠ CAUTION: Never attempt to service the PTO while it is in operation. Loose clothing could get caught in moving parts; keep clothing tight against body. Use extreme care when working around the PTO.

1. Remove the PTO housing cover and apply one shot of John Deere Multipurpose Lubricant or equivalent (See FUELS, LUBRICANTS, and COOLANT Section) to the pivot points (A) of each clutch linkage.
2. Apply one shot of John Deere Multipurpose Lubricant or equivalent to the two PTO release lever shaft fittings (B).

A—Pivot Points
B—Fittings



Use Extreme Care When Working Around the PTO

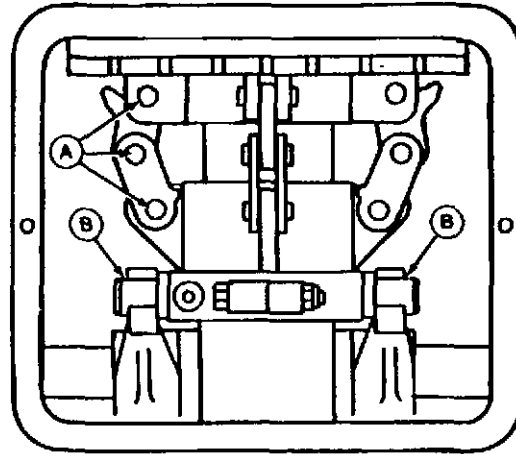

Lubrication Internal Parts of PTO Clutch

T5108 -JUN-23AUG88

RG6641 -JUN-18FEB93

RG.RG34710,5068 -19-30JAN98-1/1

CLEANING CRANKCASE VENT TUBE

If you operate the engine in dusty conditions, clean the tube at shorter intervals.

1. Remove and clean crankcase vent tube (A).
2. Install the vent tube. Be sure the tube is not pinched and O-ring fits correctly in the rocker arm cover for elbow adapter. Tighten hose clamp securely.

A—Vent Tube

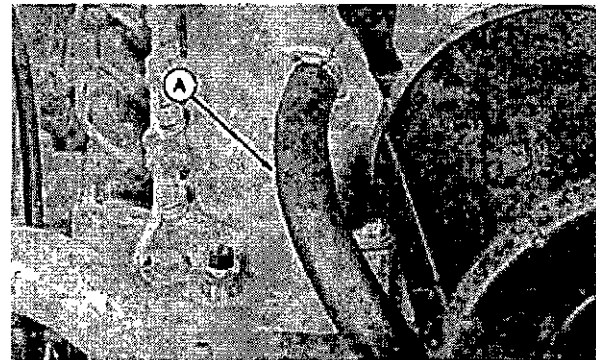

Crankcase Vent Tube

RG6005 -JUN-27JAN92

RG.RG34710,5069 -19-30JAN98-1/1

CHECKING AIR INTAKE SYSTEM

IMPORTANT: The air intake system must not leak. Any leak, no matter how small, may result in engine failure due to abrasive dirt and dust entering the intake system.

1. Inspect all intake hoses (piping) for cracks. Replace as necessary.
2. Check clamps (A) on piping which connect the air cleaner, engine, and, if present, turbocharger. Tighten clamps as necessary. This will help prevent dirt from entering the air intake system through loose connections causing internal engine damage.
3. If engine has a rubber dust unloader valve (B), inspect the valve on bottom of air cleaner for cracks or plugging. Replace as necessary.

IMPORTANT: ALWAYS REPLACE primary air cleaner element when air restriction indicator is red or shows a vacuum of at least 3.5 kPa (14 in.) H₂O, is torn, or visibly dirty.

4. Test air restriction indicator (C) for proper operation. Replace indicator as necessary.

IMPORTANT: If not equipped with air restriction indicator, replace air cleaner elements at 600 Hours or 12 Months, whichever occurs first.

5. Remove and inspect primary air cleaner element. Service as necessary. (See INSPECTING PRIMARY FILTER ELEMENT and REPLACING AIR CLEANER ELEMENTS in Service As Required Section.)

A—Clamps
B—Unloader Valve
C—Restriction Indicator

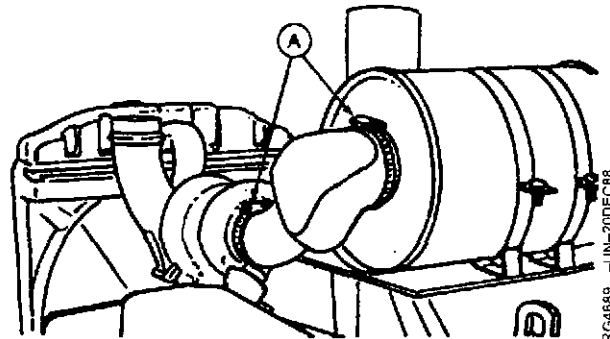

Air Cleaner Clamps

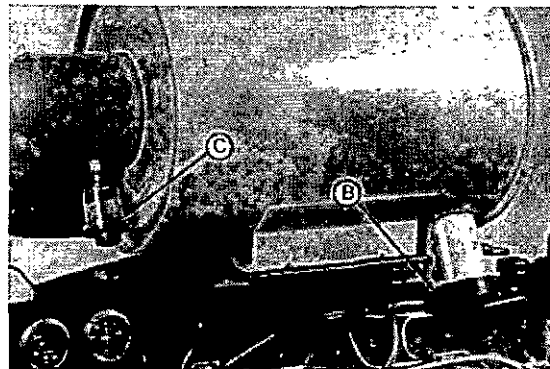

North American Air Cleaner

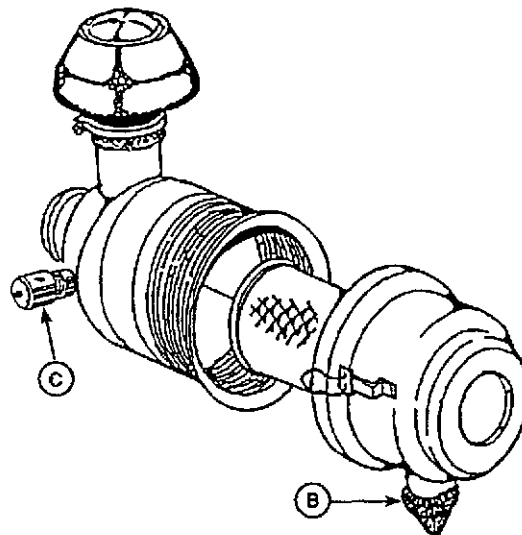

European Air Cleaner

REPLACING FUEL FILTER ELEMENT

⚠ CAUTION: Escaping fluid under pressure can penetrate the skin causing serious injury. Relieve pressure before disconnecting fuel or other lines. Tighten all connections before applying pressure. Keep hands and body away from pinholes and nozzles which eject fluids under high pressure. Use a piece of cardboard or paper to search for leaks. Do not use your hand.

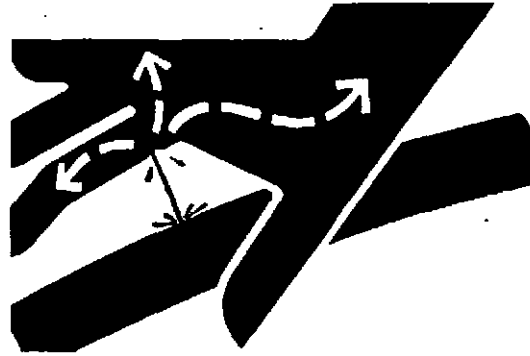

Beware of High-Pressure Fluids

If any fluid is injected into the skin, it must be surgically removed within a few hours by a doctor familiar with this type injury or gangrene may result. Doctors unfamiliar with this type of injury may call the Deere & Company Medical Department in Moline, Illinois, or other knowledgeable medical source.

1. Close fuel shut-off valve at tank, if equipped.
2. Thoroughly clean fuel filter assembly and surrounding area.
3. Loosen filter drain plug (C) and air bleed plug (D). Drain fuel into a suitable container. Dispose of fuel in an environmentally safe manner.

NOTE: Lifting up on retaining ring as it is rotated helps to get it past raised locators.

4. Firmly grasp the retaining ring (A), lift up and rotate it clockwise 1/4 turn. Remove ring with filter element (B).
5. Save retaining ring and (if equipped) water separator bowl for reuse.
6. Remove red plug from new filter and install into removed filter to protect the environment from leaking fuel.
7. Inspect filter mounting base for cleanliness. Clean as required.

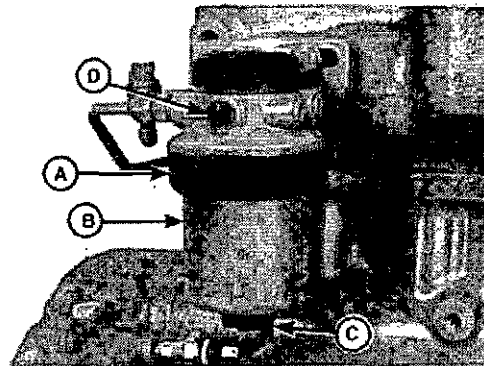

Fuel Filter

- A—Retaining Ring
- B—Filter Element
- C—Filter Drain Plug
- D—Air Bleed Plug

X9811 -UN-23AUG88

RG11570 -UN-01DEC00

8. Inspect condition of dust seal (C). Replace if necessary. Install dust seal as shown.

NOTE: Proper installation is indicated when a "click" is heard and a release of pressure on the ring is felt.

9. Align keys on filter element with slots in filter base, then tighten retaining ring counterclockwise 1/4 turn until it "snaps" into the detent. DO NOT overtighten.
10. If equipped with water separator, remove water separator bowl from removed filter element. Drain and clean separator bowl. Dry with compressed air. Install water separator bowl onto new element. Tighten securely.
11. Leave fuel shut-off valve open and bleed the fuel system. (See BLEED FUEL SYSTEM in Service As Required Section.) Tighten bleed plug.

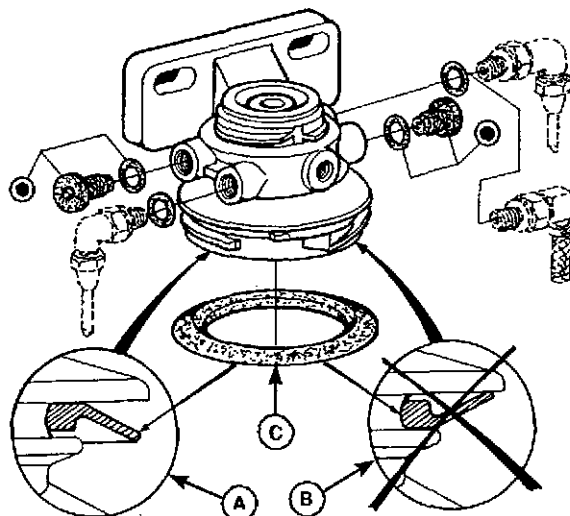

Fuel Filter Dust Seal Installation

- A—Correct Installation
- B—Incorrect Installation
- C—Seal

RG8187 -JUN-01DEC00

RG, RG34710, 5071 -19-30, JAN98-2/2

CHECKING COOLING SYSTEM

⚠ CAUTION: Explosive release of fluids from pressurized cooling system can cause serious burns.

Shut off engine. Only remove filler cap when cool enough to touch with bare hands. Slowly loosen cap to first stop to relieve pressure before removing completely.

IMPORTANT: Air must be expelled from cooling system when system is refilled. Loosen temperature sending unit fitting at rear of cylinder head to allow air to escape when filling system. Retighten fitting when all the air has been expelled.

1. Check entire cooling system for leaks. Tighten all clamps securely.
2. Thoroughly inspect all cooling system hoses. Replace hoses when hardened, softened, or cracked.
3. If coolant must be added, use mixture as recommended in Fuels, Lubricants and Coolant section.



Beware of Pressurized Fluids

TS281 -JUN-23AUC88

RG, RG34710, 5073 -19-30JAN98-1/1

TESTING DIESEL ENGINE COOLANT

Maintaining adequate concentrations of glycol and inhibiting additives in the coolant is critical to protect the engine and cooling system against freezing, corrosion, and cylinder liner erosion and pitting.

Test the coolant solution at intervals of 12 months or less and whenever excessive coolant is lost through leaks or overheating.

Coolant Test Strips

Coolant test strips are available from your John Deere dealer. These test strips provide a simple, effective method to check the freeze point and additive levels of your engine coolant.

Compare the results to the supplemental coolant additive (SCA) chart to determine the amount of inhibiting additives in your coolant and whether more John Deere COOLANT CONDITIONER should be added.

COOLSCAN

For a more thorough evaluation of your coolant, perform a COOLSCAN analysis. See your John Deere dealer for information about COOLSCAN.

DX.COOL9 -19-17FEB99-1/1

REPLENISHING SUPPLEMENTAL COOLANT ADDITIVES (SCAs) BETWEEN COOLANT CHANGES

IMPORTANT: Do not add supplemental coolant additives when the cooling system is drained and refilled with John Deere COOL-GARD®

NOTE: If system is to be filled with coolant that does not contain SCAs, the coolant must be precharged. Determine the total system capacity and premix with 3% John Deere Coolant Conditioner.

Through time and use, the concentration of coolant additives is gradually depleted during engine operation. Periodic replenishment of inhibitors is required, even when John Deere COOL-GARD® is used. The cooling system must be recharged with additional supplemental coolant additives available in the form of liquid coolant conditioner.

Maintaining the correct coolant conditioner concentration (SCAs) and freeze point is essential in your cooling system to protect against rust, liner pitting and corrosion, and freeze-ups due to incorrect coolant dilution.

John Deere LIQUID COOLANT CONDITIONER is recommended as a supplemental coolant additive in John Deere engines.

DO NOT mix one brand of SCA with a different brand.

Test the coolant solution at 600 hours or 12 months of operation using either John Deere coolant test strips or a COOLSCAN® analysis. If a COOLSCAN® analysis is not available, recharge the system per instructions printed on label of John Deere Liquid Coolant Conditioner.

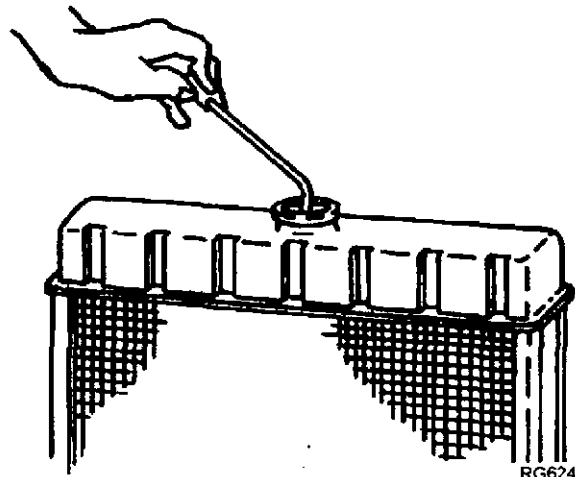

Radiator Coolant Check

RG6241

RG6261 -UN-08DEC97

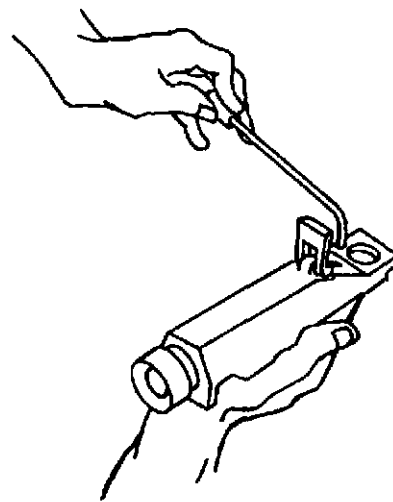

JTO7298 Coolant/Battery Tester

RG6262

RG6262 -UN-05DEC97

COOL-GARD is a registered trademark of Deere & Company
COOLSCAN is a registered trademark of Deere & Company

Continued on next page

DPSG,OUOD002,1921 -19-12DEC00-1/2

IMPORTANT: ALWAYS maintain coolant at correct level and concentration. DO NOT operate engine without coolant even for a few minutes.

If frequent coolant makeup is required, the glycol concentration should be checked with JTO7298 Coolant/Battery Tester to ensure that the desired freeze point is maintained. Follow manufacturer's instructions provided with Coolant/Battery Tester.

Add the manufacturer's recommended concentration of supplemental coolant additive. DO NOT add more than the recommended amount.

The use of non-recommended supplemental coolant additives may result in additive drop-out and gelation of the coolant.

If other coolants are used, consult the coolant supplier and follow the manufacturer's recommendation for use of supplemental coolant additives.

See DIESEL ENGINE COOLANTS AND SUPPLEMENTAL ADDITIVE INFORMATION for proper mixing of coolant ingredients before adding to the cooling system.

DPSG,OUOD002,1921 -19-12DEC00-2/2

PRESSURE TESTING COOLING SYSTEM

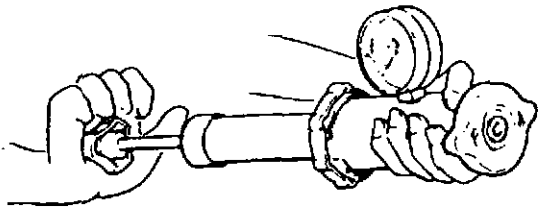

Pressure Testing Radiator Cap

RG6557 -JUN-20JAN93

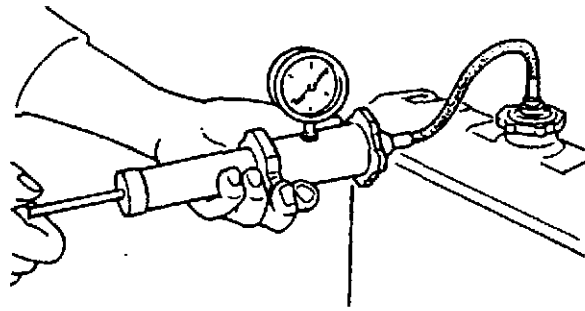

Pressure Testing Cooling System

RG6558 -JUN-20JAN93

CAUTION: Explosive release of fluids from pressurized cooling system can cause serious burns.

Shut off engine. Only remove filler cap when cool enough to touch with bare hands. Slowly loosen cap to first stop to relieve pressure before removing completely.

Test Radiator Cap

1. Remove radiator cap and attach to D05104ST Tester as shown.
2. Pressurize cap to 70 kPa (0.7 bar) (10 psi)¹. Gauge should hold pressure for 10 seconds within the normal range if cap is acceptable.

If gauge does not hold pressure, replace radiator cap.

3. Remove the cap from gauge, turn it 180°, and retest cap. This will verify that the first measurement was accurate.

Test Cooling System

NOTE: Engine should be warmed up to test overall cooling system.

1. Allow engine to cool, then carefully remove radiator cap.
2. Fill radiator with coolant to the normal operating level.

IMPORTANT: DO NOT apply excessive pressure to cooling system, doing so may damage radiator and hoses.

3. Connect gauge and adapter to radiator filler neck. Pressurize cooling system to 70 kPa (0.7 bar) (10 psi)¹.
4. With pressure applied, check all cooling system hose connections, radiator, and overall engine for leaks.

If leakage is detected, correct as necessary and pressure test system again.

If no leakage is detected, but the gauge indicated a drop in pressure, coolant may be leaking internally within the system or at the block-to-head gasket. Have your servicing dealer or distributor correct this problem immediately.

¹Test pressures recommended are for all Deere OEM cooling systems. On specific-vehicle applications, test cooling system and pressure cap according to the recommended pressure for that vehicle.

Lubrication & Maintenance / 1200 Hour / 24 Month

CHECKING AND ADJUSTING ENGINE VALVE CLEARANCE

NOTE: Adjust engine valve clearance after the first 400 hours of engine operation and then at the normal 1200 Hour/24 Month interval thereafter.

If desired, have your authorized servicing dealer or engine distributor adjust the engine valve clearance.

CAUTION: To prevent accidental starting of engine while performing valve adjustments, always disconnect **NEGATIVE (-)** battery terminal.

IMPORTANT: Engine valve clearance **MUST BE** checked and adjusted with engine **COLD**.

1. Remove rocker arm cover and crankcase ventilator tube.

IMPORTANT: Visually inspect contact surfaces of wear caps and rocker arm wear pads. Check all parts for excessive wear, breakage, or cracks. Replace parts that show visible damage.

Rocker arms that exhibit excessive valve clearance should be inspected more thoroughly to identify damaged parts.

2. Remove plastic plugs or cover plate from flywheel housing timing holes (A).

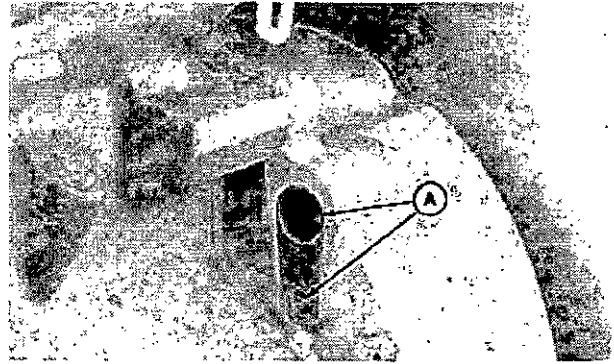

Flywheel Housing Timing Holes

A—Timing Holes

RG6305 -JUN-03AUG92

Continued on next page

RG.RG34710.5067 -19-30JAN98-1/3

- Using JDE83 Engine Rotation Tool and JDE81-4 Timing Pin, rotate engine in running direction (clockwise viewed from front) until Number 1 (front) cylinder is at Top Dead Center (TDC) Compression stroke. Insert timing pin in flywheel.

If Number 1 cylinder rocker arms are loose, the engine is at Number 1 "TDC-Compression".

If Number 1 cylinder rocker arms are not loose, rotate engine one full revolution (360°) to Number 1 "TDC-Compression".

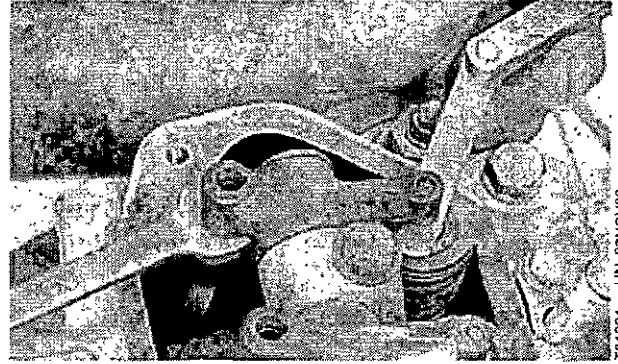

Checking Valve Clearance

NOTE: Firing order is 1-2-3.

- With engine lock-pinned at "TDC" of Number 1 piston's compression stroke (B), check valve clearance using a feeler gauge on Number 1 and 2 exhaust valves and Number 1 and 3 intake valves.

Specification

Intake Valve Clearance Checking (Rocker Arm-to-Valve Tip) (Engine Cold)—Specification—	
Clearance	0.31—0.38 mm (0.012—0.015 in.)
Exhaust Valve Clearance Checking (Rocker Arm-to-Valve Tip) (Engine Cold)—	
Specification—Clearance	0.41—0.48 mm (0.016—0.019 in.)

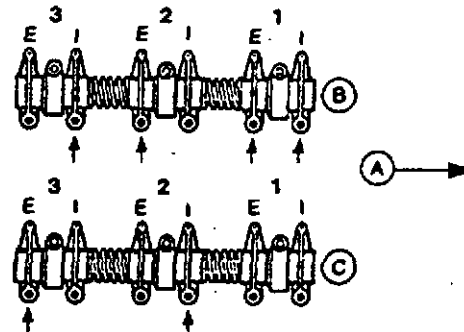

Valve Adjusting Order

- A—Front of Engine
- B—Number 1Piston at TDC Compression Stroke
- C—Number 1 Piston at TDC Exhaust Stroke
- E—Exhaust Valve
- I—Intake Valve

- Rotate flywheel 360 degrees and lock Number 1 piston at "TDC" exhaust stroke (C).
- Check valve clearance on Number 3 exhaust valve and Number 2 intake valve.
- If valves need adjusting, use following valve clearance adjustment procedure and specifications. Loosen the locknut on rocker arm adjusting screw. Turn adjusting screw until feeler gauge slips with a slight drag. Hold the adjusting screw from turning with screwdriver and tighten locknut to specifications. Recheck clearance again after tightening locknut. Readjust clearance as necessary.

Specification

Intake Valve Clearance
Adjustment (Rocker Arm-to-Valve
Tip) (Engine Cold)—
Specification—Clearance 0.36 mm (0.014 in.)
Exhaust Valve Clearance
Adjustment (Rocker Arm-to-Valve
Tip) (Engine Cold)—
Specification—Clearance 0.46 mm (0.018 in.)
Rocker Arm Adjusting Screw Jam
Nut—Specification—Torque 27 N·m (20 lb-ft)

8. Replace rocker arm cover and crankcase vent tube.

RG.RG34710,5067 -19-30JAN98-3/3

ADJUSTING VARIABLE SPEED (DROOP) ON GENERATOR SET ENGINES (STANADYNE INJECTION PUMPS ONLY)

⚠ CAUTION: Statutes providing severe penalties for tampering with emissions controls may apply at the user's location.

1. Warm engine to normal operating temperature.
2. If necessary, disconnect throttle linkage or cable.
3. Run engine at fast idle. Check and adjust fast idle speed when necessary.
4. Apply full load.
5. Check power. Adjust with knob or screw (A) if needed.
6. Remove load.
7. Check and adjust fast idle if knob or screw (A) has been turned.
8. Repeat procedure until both the engine power and fast idle speed are correct.
9. Connect throttle linkage if previously removed.

A—Screw

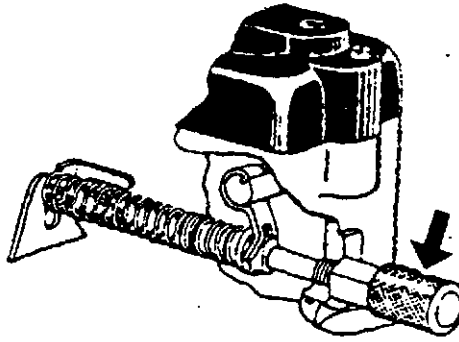

Droop Adjusting Knob

T86735 -UN-23FEB89

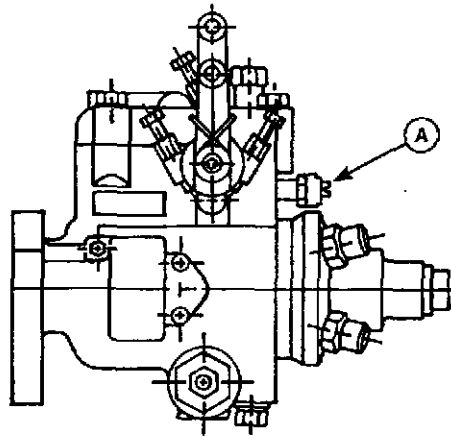

Droop Adjusting Screw

RG8418 -UN-01DEC00

RG.RG34710,5076 -19-30JAN98-1/1

FLUSHING AND REFILLING COOLING SYSTEM

⚠ CAUTION: Explosive release of fluids from pressurized cooling system can cause serious burns.

Shut off engine. Only remove filler cap when cool enough to touch with bare hands. Slowly loosen cap to first stop to relieve pressure before removing completely.

NOTE: Drain the initial factory fill engine coolant after the first 2000 hours or 24 months of operation. Subsequent drain intervals are determined by the coolant used for service.

When John Deere COOL-GARD[®] is used, the drain interval is 3000 hours or 36 months. The drain interval may be extended to 5000 hours or 60 months of operation provided that the coolant is tested annually AND additives are replenished as needed, by adding a supplemental cooling additive (SCA).

If COOL-GARD[®] is not used, the drain interval is reduced to 2000 hours or 24 months of operation.

Drain old coolant, remove thermostat, flush the entire cooling system, install thermostat, and fill with recommended clean coolant. For correct coolant mixture, refer to Fuels, Lubricants and Coolant section.

Perform these procedures as follows:

1. Pressure test entire cooling system and pressure cap if not previously done. (See PRESSURE TESTING COOLING SYSTEM, earlier in this section.)
2. Slowly open the engine cooling system filler cap or radiator cap to relieve pressure and allow coolant to drain faster.



Beware of High Pressure Fluids

TS281 -UN-23AUG88

3. Open engine block drain valve or plug (A) on left side of engine. Drain all coolant from engine block.
4. Open radiator drain valve. Drain all coolant from radiator.
5. Remove thermostat at this time, if not previously done. Install cover (B) (without thermostat) and tighten cap screws to specification.

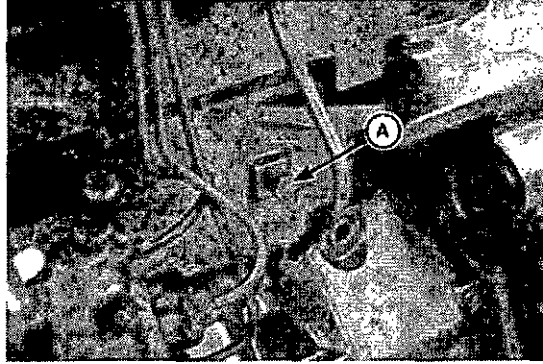

RG7315 -UN-01DEC00

Engine Block Drain Valve

Specification
Capscrews—Torque..... 47 N•m (35 lb ft)

6. Test thermostat opening temperature. (See TEST THERMOSTAT OPENING TEMPERATURE following in this Section.)
7. Close all drain valves after coolant has drained.

⚠ CAUTION: Do not run engine longer than 5 minutes (at low idle) with water as coolant. Doing so may cause engine to overheat which may cause burns when water is draining.

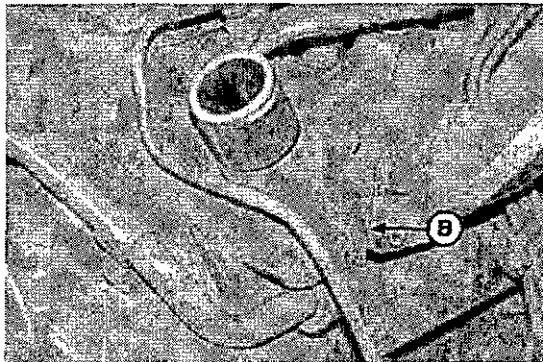

RG11997 -UN-08DEC00

Thermostat Housing

8. Fill the cooling system with clean water. Run the engine about 5 minutes at low idle to stir up possible rust or sediment.
9. Stop engine, pull off lower radiator hose and remove radiator cap to immediately drain the water from the system before rust and sediment settle.
10. After draining water, close drain valves. Install radiator cap, radiator hose and clamp. Fill the cooling system with clean water and a heavy duty cooling system cleaner such as FLEETGUARD® RESTORE™ or RESTORE PLUS™. Follow manufacturer's directions on label.

A—Plug
B—Cover

FLEETGUARD is a trademark of Cummins Engine Company, Inc.
RESTORE is a trademark of Fleetguard Inc.
RESTORE PLUS is a trademark of Fleetguard Inc.

Continued on next page

RG, RG34710, 5079 -19-30JAN98-2/3

- After cleaning the cooling system, drain cleaner and fill with water to flush the system. Run the engine about 5 minutes, remove radiator cap and pull off lower radiator hose, immediately draining out flushing water.

IMPORTANT: Air must be expelled from cooling system when system is refilled. Loosen temperature sending unit fitting at rear of cylinder head to allow air to escape when filling system. Retighten fitting when all the air has been expelled.

- Close all drain valves on engine and radiator. Install lower radiator hose and tighten clamp.

NOTE: Install thermostat with jiggle wire (A) at top position.

- Install thermostat and cover using a new gasket. Tighten cap screws to specification.

Specification

Capscrews—Torque..... 47 N•m (35 lb ft)

- Add coolant to radiator until coolant touches bottom of filler neck¹. (See ADDING COOLANT in Service As Required Section.)

- Run engine until it reaches operating temperature. This mixes the solution uniformly and circulates it through the entire system. The normal engine coolant temperature range is 82°–94°C (180°–202°F).

- After running engine, check coolant level and entire cooling system for leaks.

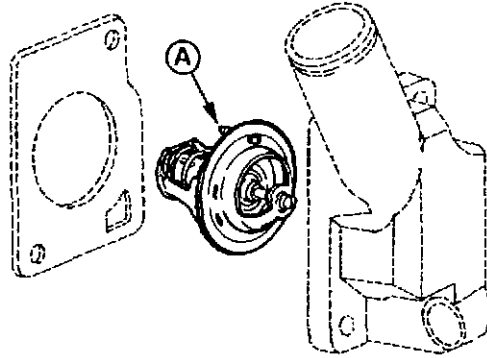

Jiggle Wire

A—Jiggle Wire

RG11605 -UN-24JAN01

¹Cooling system capacity for the Saran-sourced 3029 L engine factory generator set package is 12 L (11.5 qt). Refer to OEM manufacturer for capacities of cooling systems not supplied by John Deere.

TESTING THERMOSTAT OPENING TEMPERATURE

1. Remove thermostat.
2. Visually inspect thermostat for corrosion or damage.

⚠ CAUTION: DO NOT allow thermostat or thermometer to rest against the side or bottom of container when heating water. Either may rupture if overheated.

3. Suspend thermostat and a thermometer in a container of water.
4. Stir the water as it heats. Observe opening action of thermostat and compare temperatures with specification given in chart below.

NOTE: Due to varying tolerances of different suppliers, initial opening and full open temperatures may vary slightly from specified temperatures.

THERMOSTAT TEST SPECIFICATIONS

Rating	Initial Opening (Range)	Full Open (Nominal)
82°C (180°F)	80-84°C (175-182°F)	94°C (202°F)

5. Remove thermostat and observe its closing action as it cools. In ambient air the thermostat should close completely. Closing action should be smooth and slow.
6. Replace thermostat if opening temperature is not within specification.

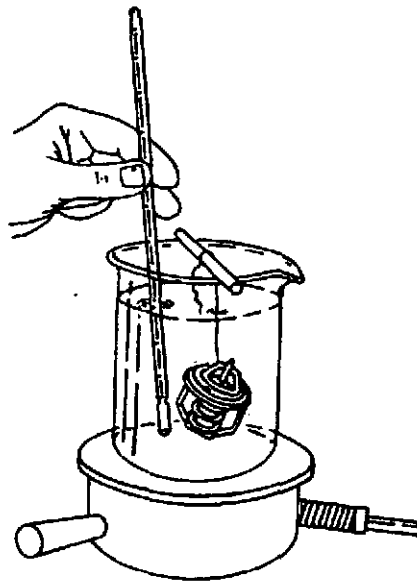

Testing Thermostats

RG5971 -JUN-23NOV87

RG, RG34710, 5083 -19-30JAN98-1/1

Service As Required

ADDITIONAL SERVICE INFORMATION

This is not a detailed service manual. If you want more detailed service information, see John Deere Service Literature Available later in this manual to order the Component Technical Manuals for "Repair" and "Operation and Diagnosis".

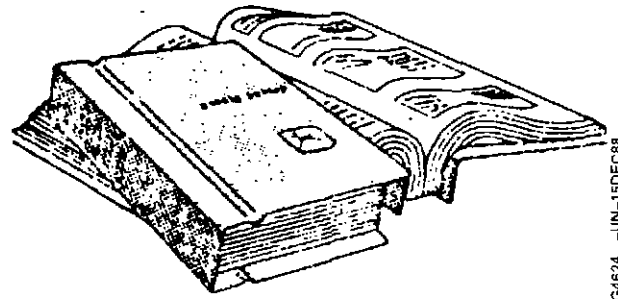

John Deere Service Manuals

RG4624 -UN-15DEC88

RG.RG34710,5080 -19-30JAN98-1/1

DO NOT MODIFY FUEL SYSTEM

IMPORTANT: Modification or alteration of the injection pump, the injection pump timing, or the fuel injectors in ways not recommended by the manufacturer will terminate the warranty obligation to the purchaser.

In addition, tampering with fuel system which alters emission-related equipment on engines may result in fines or other penalties, per EPA regulations or other local emission laws.

Do not attempt to service injection pump or fuel injectors yourself. Special training and special tools are required. (See your authorized servicing dealer or engine distributor.)



T81389 -19-

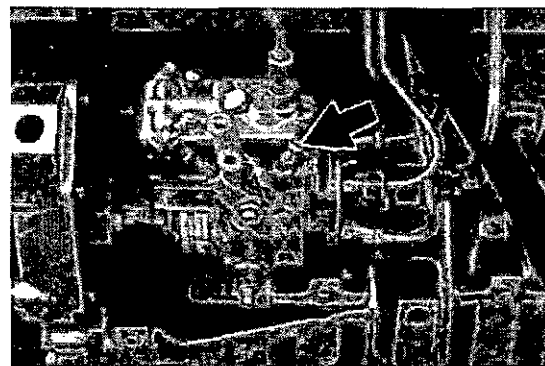

Fuel Injection Pump

RG11546 -UN-01DEC00

RG.RG34710,5081 -19-30JAN98-1/1

ADDING COOLANT

⚠ CAUTION: Explosive release of fluids from pressurized cooling system can cause serious burns.

Shut off engine. Only remove filler cap when cool enough to touch with bare hands. Slowly loosen cap to first stop to relieve pressure before removing completely.

IMPORTANT: Never pour cold liquid into a hot engine, as it may crack cylinder head or block. NEVER operate engine without coolant.

John Deere TY15161 Cooling System Sealer may be added to the radiator to stop leaks on a temporary or emergency basis only. DO NOT use any other stop-leak additives in the cooling system. Leaks should be permanently repaired as quickly as possible.

Air must be expelled from cooling system when coolant is added.

1. Loosen temperature sending unit fitting (A) at rear of cylinder head to allow air to escape when filling system.

IMPORTANT: When adding coolant to the system, use the appropriate coolant solution. (See ENGINE COOLANT SPECIFICATIONS in Fuels, Lubricants, and Coolant Section for mixing of coolant ingredients before adding to cooling system.)

Do not overfill cooling system. A pressurized system needs space for heat expansion without overflowing at top of radiator.

2. Fill until coolant level touches bottom of radiator filler neck.
3. Tighten fitting when air has been expelled from system.

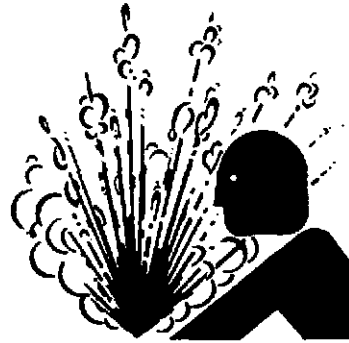

High Pressure Fluids

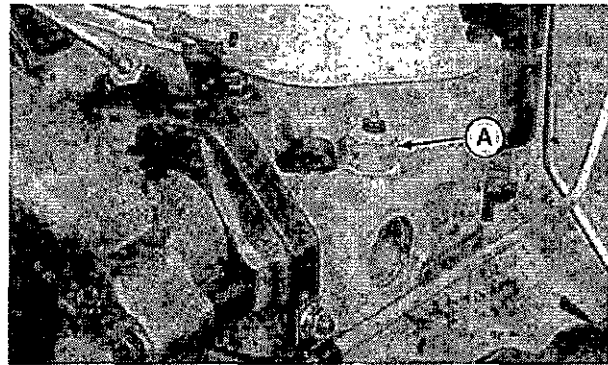

Sending Unit Fitting

A—Sending Unit Fitting

TS2281 -JUN-23AUG88

RG11607 -JUN-25JAN01

BLEEDING THE FUEL SYSTEM

CAUTION: Escaping fluid under pressure can penetrate the skin causing serious injury. Relieve pressure before disconnecting fuel or other lines. Tighten all connections before applying pressure. Keep hands and body away from pinholes and nozzles which eject fluids under high pressure. Use a piece of cardboard or paper to search for leaks. Do not use your hand.

If ANY fluid is injected into the skin, it must be surgically removed within a few hours by a doctor familiar with this type injury or gangrene may result. Doctors unfamiliar with this type of injury may call the Deere & Company Medical Department in Moline, Illinois, or other knowledgeable medical source.

Whenever the fuel system has been opened up for service (lines disconnected or filters removed), it will be necessary to bleed air from the system.

1. Loosen the air bleed vent screw (A) two full turns.
2. On mechanical supply pumps, operate supply pump primer lever (B) until fuel flow is free from air bubbles.
3. On electric supply pumps, turn key switch to "ON" position until fuel flow is free from air bubbles.
4. Tighten bleed plug securely by hand. Continue operating hand primer until pumping action is not felt. When finished, pull hand primer outward (away from engine) as far as it will go.
5. Start engine and check for leaks.

If engine will not start, it may be necessary to bleed air from fuel system at fuel injection pump or injection nozzles as explained next.

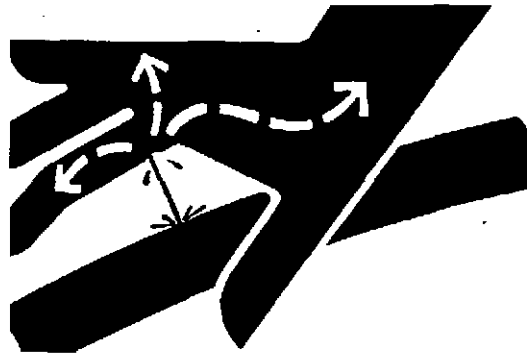

Keep Skin Away from High Pressure Fluids

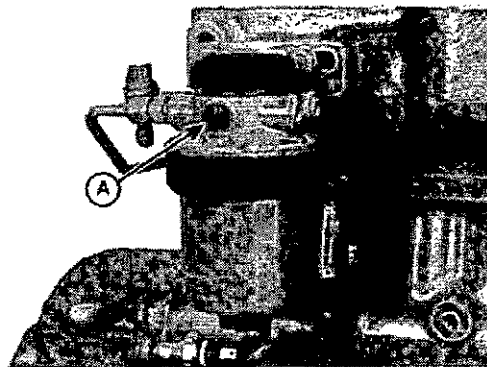

Fuel Filter Air Bleed Vent Screw

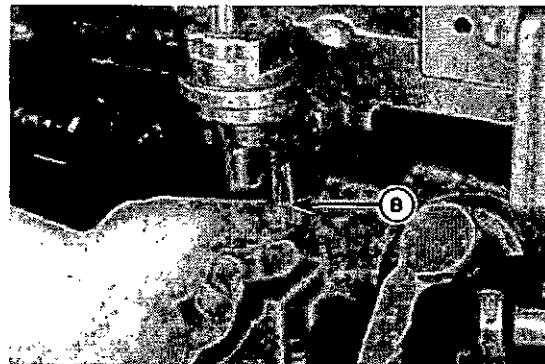

Fuel Supply Pump Primer Lever

A—Vent Screw
B—Primer Lever

X9611 -JUN-23AUG88

RG11544 -JUN-01DEC00

RG11545 -JUN-01DEC00

At Fuel Injection Pump

1. Slightly loosen fuel supply line connector (A) at injection pump.
2. On mechanical supply pumps, operate fuel supply pump primer lever until fuel, without air bubbles, flows from fuel line connection.
3. On electric supply pumps, turn key switch to "ON" position until fuel, without air bubbles, flows from fuel line connection.
4. Tighten fuel supply line connector to specification.

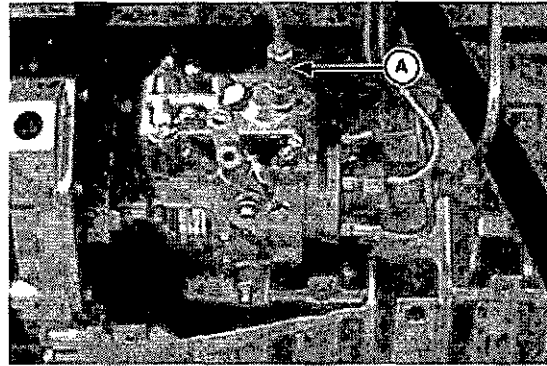

RG7316 -JUN-01DEC00

Fuel Supply Line Connector at Injection Pump

A—Connector

Specification

Connector—Torque 16 N·m (12 lb ft)

5. Leave hand primer in the outward position away from cylinder block.

RG, RG34710, 5084 -19-30JAN98-2/3

At Fuel Injection Nozzles

1. Move the speed control lever to half throttle position. On engines equipped with electronic fuel shut-off solenoid, energize solenoid.
2. Using two open-end wrenches, loosen fuel line connection at injection nozzle.
3. Crank engine over with starting motor, (but do not start engine), until fuel free from air bubbles flows out of loosened connection. Tighten connection to specification.



T92924 -JUN-01NOV88

Bleeding Fuel System at Injection Nozzle

Specification

Connection—Torque 27 N·m (20 lb ft)

4. Repeat procedure for remaining injection nozzles (if necessary) until all air has been removed from fuel system.

If engine still will not start, see your authorized servicing dealer or engine distributor.

RG, RG34710, 5084 -19-30JAN98-3/3

REPLACING AIR CLEANER FILTER ELEMENTS

IMPORTANT: ALWAYS REPLACE primary air cleaner element when air restriction indicator shows a vacuum of at least 3.5 kPa (14 in.) of H₂O, is torn, or visibly dirty.

NOTE: This procedure applies to John Deere air cleaner kits. Refer to manufacturers' instructions for servicing air cleaners not supplied by John Deere.

North American Air Cleaners

1. Remove wing nut and remove canister cover shown in small illustration inset.
2. Remove wing nut (A) and remove primary element (B) from canister.
3. Thoroughly clean all dirt from inside canister.

NOTE: Some engines may have a dust unloader valve (C) on the air cleaner. If equipped, squeeze valve tip to release any trapped dirt particles.

IMPORTANT: Remove secondary (safety) element (E) ONLY for replacement. DO NOT attempt to clean, wash, or reuse secondary element. Replacement of secondary element is usually necessary ONLY when primary element has a hole in it.

4. To replace secondary element, remove retaining nut (D) and secondary element (E). Immediately replace secondary element with new element to prevent dust from entering air intake system.

5. Install new primary element and tighten wing nut securely. Install cover assembly and tighten retaining wing nut securely.

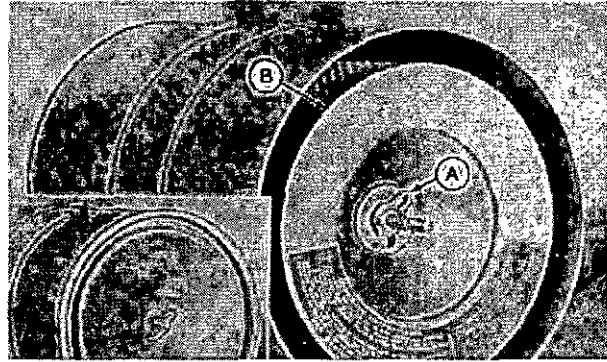

Air Cleaner Primary Element (North American)

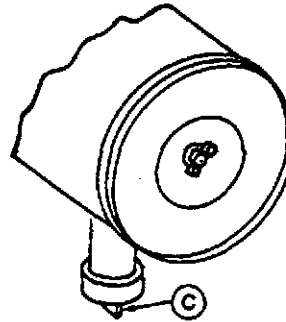

Dust Unloader Valve

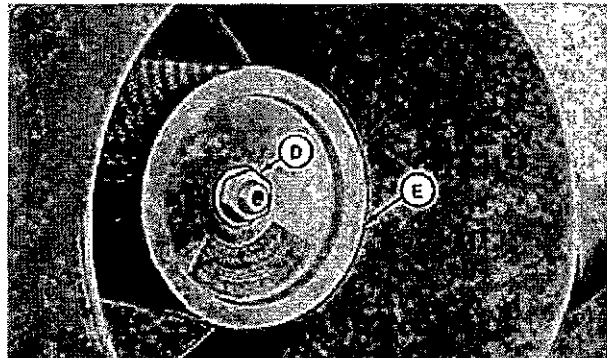

Air Cleaner Secondary Element

- A—Wing Nut
- B—Primary Element
- C—Unloader Valve
- D—Retaining Nut
- E—Secondary Element

Continued on next page

DPSG,OUOD002,1580 -19-21JUN00-1/2

IMPORTANT: Whenever the air cleaner has been serviced or had cover removed, **ALWAYS** fully depress the air restriction indicator reset button (if equipped) to assure accurate readings.

6. If equipped, fully depress air restriction indicator reset button and release to reset indicator.

On European Sourced Air Cleaner Kits:

Clean filter element when air restriction indicator (A) is red. Replace filter element every 6 cleanings or once every 12 months.

1. Remove cover (B).
2. Remove filter element (C).
3. Thoroughly clean all dirt from inside filter housing.
4. Squeeze dust unloader valve (D) to remove dust deposits. If clogged, remove and clean the dust unloader valve. Replace if damaged.
5. Clean filter element using compressed air.
6. Reinstall the filter element and cover.
7. Depress air restriction indicator (A) button and release to reset indicator.

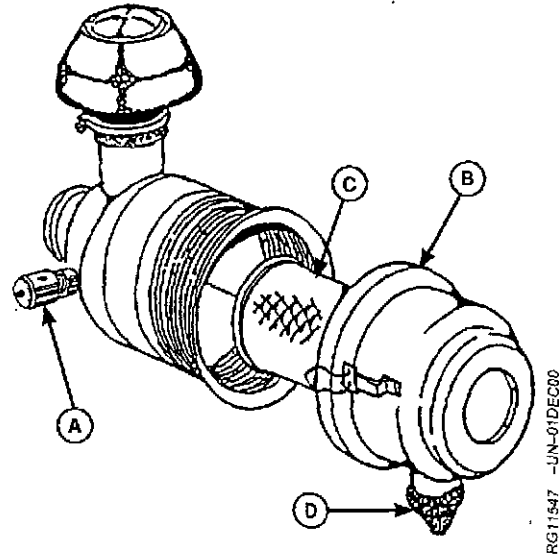

Air Cleaner Components (European Sourced)

- A—Restriction Indicator
- B—Cover
- C—Filter Element
- D—Dust Unloader Valve

RG11547 -JN-01DEC00

INSPECTING PRIMARY FILTER ELEMENT

Inspect filter to determine if it is practical to clean or for damage after cleaning filter.

1. Hold a bright light (A) inside element and check carefully for holes. Discard any element which shows the smallest hole or rupture.
2. Be sure outer screen (B) is not dented. Vibration would quickly wear a hole in filter.
3. Be sure filter gasket (C) is in good condition. If gasket is damaged or missing, replace element.

IMPORTANT: Air cleaner MUST BE DRY before storing in plastic bag.

If the filter is to be stored for later use, place it in a plastic bag to protect it from dust and damage.

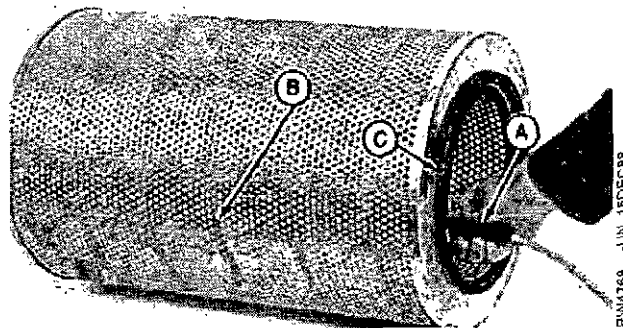

Inspecting Primary Air Filter Element

A—Light
B—Outer Screen
C—Gasket

RG, RG34710, 3598 -19-30AUG96-1/1

CLEANING PRIMARY FILTER ELEMENT

IMPORTANT: Always replace secondary (safety) filter elements. DO NOT attempt to clean them.

Do not blow air from outside portion of filter with air nozzle. Wear safety glasses and remove bystanders.

1. Gently pat sides of element with palm of hand to loosen dirt. DO NOT tap element against a hard surface.

Continued on next page

RG, RG34710, 3599 -19-30AUG96-1/2

CAUTION: Only a special air cleaning gun (A) should be used. Concentrated air pressure from an ordinary air nozzle may severely damage filter element. Do not exceed 210 kPa (2.1 bar) (30 psi) when cleaning filter element.

2. Insert the cleaning gun into element, hold air nozzle about 25.4 mm (1.0 in.) from perforated metal retainer. Force air through filter from inside to outside and move air gun up and down pleats to remove as much dirt as possible.
3. Repeat steps 1 and 2 to remove additional dirt.
4. Inspect element for damage after cleaning. Replace element if any damage is found.

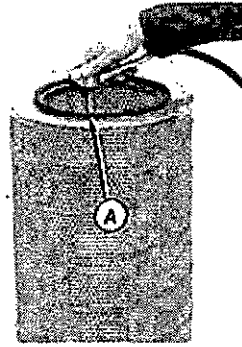

Cleaning Primary Element

A—Air Cleaning Gun

RG11065 -JUN-26JUN00

RG, RG34710.3599 -19-30AUG96-2/2

ELEMENT STORAGE

IMPORTANT: Air cleaner element **MUST BE DRY** before storing in plastic bag.

Seal element in a plastic bag and store in shipping container to protect against dust and damage.

RG, RG34710.3601 -19-30AUG96-1/1

REPLACE FAN AND ALTERNATOR BELTS

Inspect belts for cracks, fraying, or stretched out areas. Replace if necessary. (See CHECKING FAN AND ALTERNATOR V-BELT TENSION in Lubrication and Maintenance/250 Hour Section.)

RG, RG34710.5086 -19-30JAN98-1/1

POWER TAKE-OFF (PTO) CLUTCH

⚠ CAUTION: Entanglement in rotating driveline can cause serious injury or death. Keep shield on PTO drive shaft (A) between the clutch housing and the engine driven equipment at all times during engine operation. Wear close fitting clothing. Stop the engine and be sure PTO driveline is stopped before making adjustments.

Proper performance of the power take-off unit will be related to the care it is given. Lubricate it periodically and keep the clutch properly adjusted. (See LUBRICATION AND MAINTENANCE/250 HOUR Section.)

If the power take-off does not work properly after adjustment and lubrication, contact your authorized servicing dealer or engine distributor.

A—PTO Driveshaft



Beware of Rotating Drivelines

TS188 -JUN-23AUG88

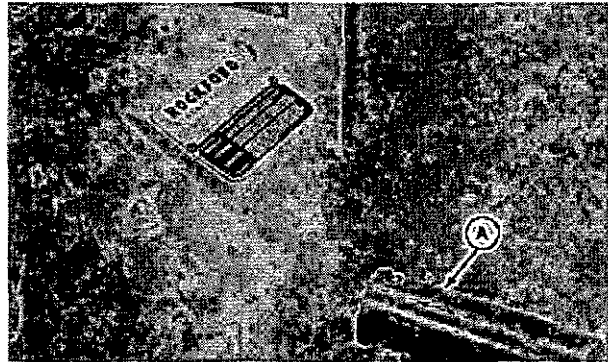

PTO Drive Shaft

RC24833 -JUN-14DEC88

RG.RG34710,5087 -19-30JAN98-1/1

CHECKING FUSES

The following instructions apply to engines equipped with a John Deere instrument panel.

On North American Instrument Panels:

1. Check the fuse (A) and replace as necessary with an equivalent 14-amp fuse.

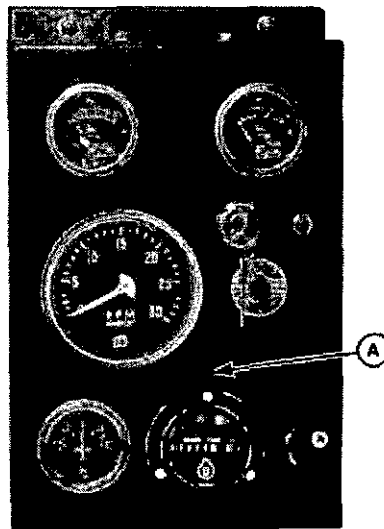

North American Instrument Panel

RG11548 -JUN-01DEC00

Continued on next page

OJODD13.0000003 -19-28NOV00-1/3

On AEZ Instrument Panels (Except North America):

1. Remove the four cap screws (B) holding the instrument panel board.
2. Open fuse holder (C).
3. Replace as necessary with an equivalent 16-amp fuse (D).

IMPORTANT: Always replace a blown fuse with a fuse of the same amperage.

4. Reinstall the instrument panel board.

- B—Cap Screws
- C—Fuse Holder
- D—16-Amp Fuse

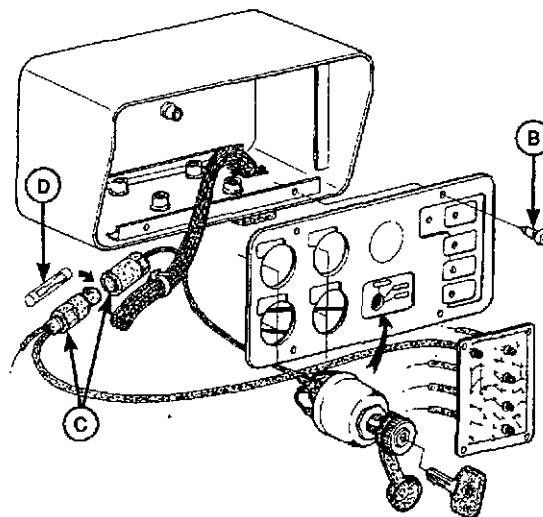

AEZ Instrument Panel (Except North America)

RG8149 -UN-01DEC00

OUID013.0000003 -19-28NOV00-2/3

On VDO Instrument Panels (Except North America):

5. The fuse is located on the electronic control card inside the panel's rear access cover. Remove cover and check fuse. If defective, replace with a 10 amp fuse. There is a spare fuse available on the card in the "SPARE" terminal.

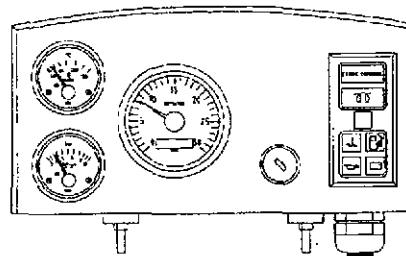

VDO Instrument Panel (Except North America)

RG10606A -UN-19JUN00

OUID013.0000003 -19-28NOV00-3/3

Troubleshooting

GENERAL TROUBLESHOOTING INFORMATION

Troubleshooting engine problems can be difficult. An engine wiring diagram is provided in this section to help isolate electrical problems on power units using John Deere wiring harness and instrument (gauge) panel.

Later in this section is a list of possible engine problems that may be encountered accompanied by possible causes and corrections. The illustrated diagrams and troubleshooting information are of a general nature, final design of the overall system for your engine application may be different. See your engine distributor or servicing dealer if you are in doubt.

A reliable program for troubleshooting engine problems should include the following basic diagnostic thought process:

- Know the engine and all related systems.
- Study the problem thoroughly.
- Relate the symptoms to your knowledge of engine and systems.
- Diagnose the problem starting with the easiest things first.
- Double-check before beginning the disassembly.
- Determine cause and make a thorough repair.
- After making repairs, operate the engine under normal conditions to verify that the problem and cause were corrected.

RG, RG34710, 5089 -19-30JAN98-1/1

NORTH AMERICAN WIRING DIAGRAM

S1 KEY SWITCH					
	B	G	ACC.	ON	ST.
OFF					
ACC.	•		•		
ON	•		•	•	
START	•	•		•	•

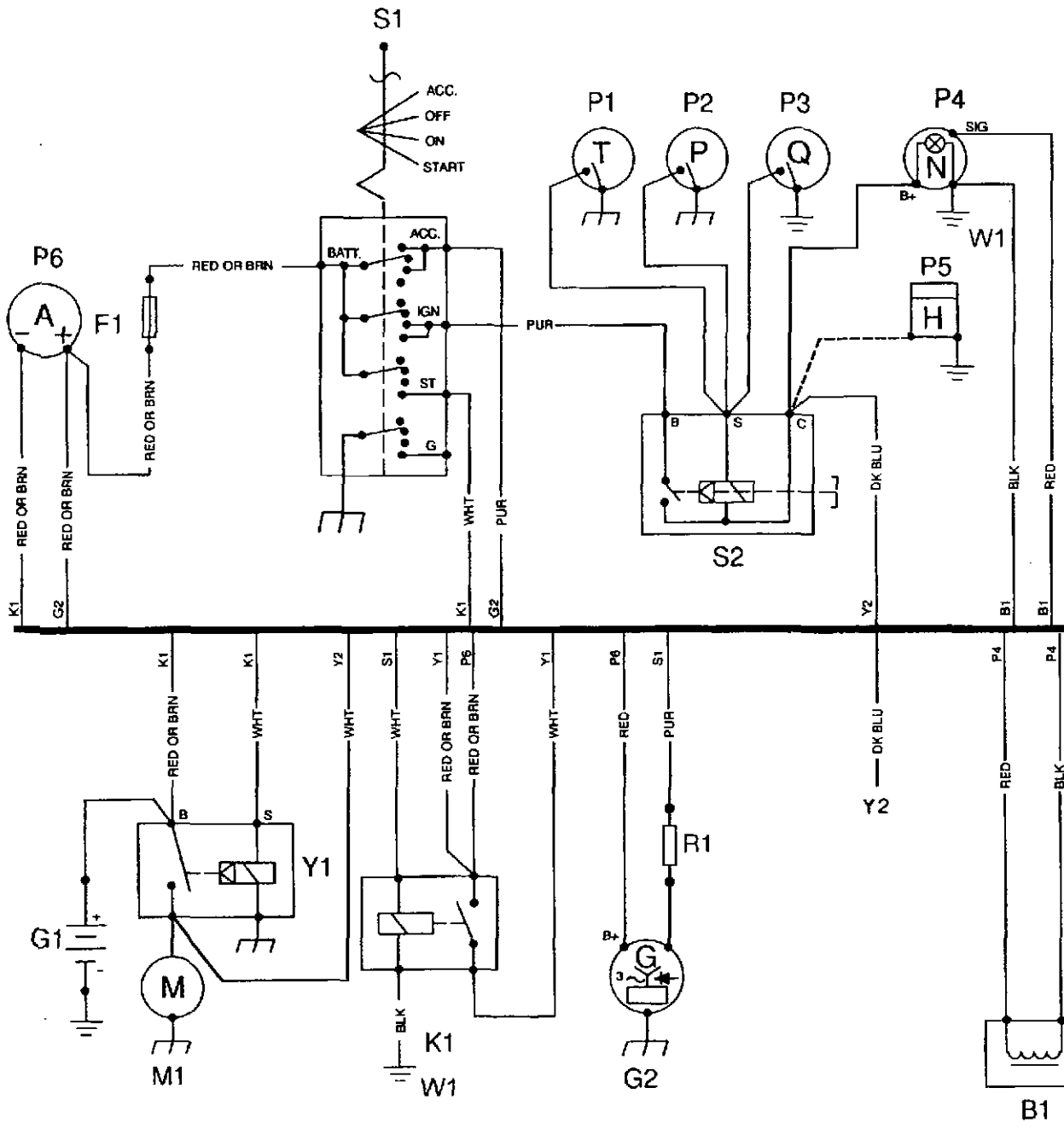

North American Wiring Diagram

Continued on next page

RG, RG34710, 5091 -19-30JAN98-1/2

Troubleshooting

A1—Speed Control Unit	H2—Oil Pressure Indicator Lamp	P6—Ammeter	Y2—Fuel Shut-Off Solenoid
B1—Magnetic Speed Sensor	K1—Starter Relay	R1—Resistor (48 ohm)	BLK—Black
B2—Coolant Temperature Sensor	M1—Starter Motor	S1—Key Switch	BLU—Blue
B3—Oil Pressure Sensor	P1—Coolant Temperature Gauge	S2—Magnetic Safety Switch— North American, Auto Override Module— European (Saran)	BRN—Brown
F1—Starting Circuit Fuse (14 Amp)	P2—Oil Pressure Gauge	W1—Ground on K1 Starter Relay Mounting Stud	DK BLU—Dark Blue
F3—Fuse (Early Models) ¹	P3—Crankcase Oil Level Switch/Gauge	Y1—Starter Solenoid	GRN—Green
G1—Battery	P4—Tachometer ¹		ORG—Orange
G2—Alternator	P5—Hourmeter ²		PUR—Purple
H1—Coolant Temperature Indicator Light			RED—Red
			YEL—Yellow

¹P4 tachometer has a built-in hourmeter. On some earlier engines, a separate hourmeter (P5) and fuse (F3) are used.

²P4 tachometer has a built-in hourmeter. On some engines, a separate hourmeter (P5) and fuse (F3) are used.

RG.RG34710,5091 -19-30.JAN98-2/2

ENGINE TROUBLESHOOTING

Symptom	Problem	Solution
Engine Will Not Crank	Weak battery	Replace battery.
	Corroded or loose battery connections	Clean battery terminals and connections.
	Defective main switch or start safety switch	Repair switch as required.
	Starter solenoid defective	Replace solenoid.
	Starter defective	Replace starter.
Engine cranks but will not start	Incorrect starting procedure.	Verify correct starting procedure.
	No fuel.	Check fuel in tank and manual shut-off valve.
	Exhaust restricted.	Check and correct exhaust restriction.
	Fuel filter plugged or full of water.	Replace fuel filter or drain water from filter.
	Injection pump not getting fuel or air in fuel system.	Check fuel flow at supply pump or bleed fuel system.
	Faulty injection pump or nozzles.	Consult authorized diesel repair station for repair or replacement.

Continued on next page

RG, RG34710, 5092 -19-30JAN98-1/8

Troubleshooting

Symptom	Problem	Solution
Engine hard to start or will not start	Engine starting under load.	Disengage PTO.
	Improper starting procedure.	Review starting procedure.
	No fuel.	Check fuel tank.
	Air in fuel line.	Bleed fuel line.
	Cold weather.	Use cold weather starting aids.
	Slow starter speed.	See "Starter Cranks Slowly".
	Crankcase oil too heavy.	Use oil of proper viscosity.
	Improper type of fuel.	Consult fuel supplier; use proper type fuel for operating conditions.
	Water, dirt, or air in fuel system.	Drain, flush, fill, and bleed system.
	Clogged fuel filter.	Replace filter element.
	Dirty or faulty injection nozzles.	Have authorized servicing dealer or engine distributor check injectors.
	Injection pump shut-off not reset.	Turn key switch to "OFF" then to "ON".
	Poor fuel quality	Drain fuel and replace with quality fuel of the proper grade.
	Slow cranking speed	Check for problem in the charging/starting system.
	Engine knocks	Low engine oil level.
Injection pump out of time.		See your authorized servicing dealer or engine distributor.
Low coolant temperature.		Remove and check thermostat.
Engine overheating.		See "Engine Overheats".

Continued on next page

RG, RG34710, 5092 -19-30, JAN98-2/8

Troubleshooting

Symptom	Problem	Solution
Engine runs irregularly or stalls frequently	Low coolant temperature.	Remove and check thermostat.
	Clogged fuel filter.	Replace fuel filter element.
	Water, dirt, or air in fuel system.	Drain, flush, fill, and bleed system.
	Dirty or faulty injection nozzles.	Have authorized servicing dealer or engine distributor check injectors.
Below normal engine temperature	Defective thermostat.	Remove and check thermostat.
	Defective temperature gauge or sender.	Check gauge, sender, and connections.

Continued on next page

RG, RG34710.5092 -19-30JAN98-3/8

Troubleshooting

Symptom	Problem	Solution
Lack of power	Engine overloaded.	Reduce load.
	Intake air restriction.	Service air cleaner.
	Clogged fuel filter.	Replace filter elements.
	Improper type of fuel.	Use proper fuel.
	Poor fuel quality	Drain fuel and replace with quality fuel of the proper grade.
	Overheated engine.	See "Engine Overheats".
	Below normal engine temperature.	Remove and check thermostat.
	Improper valve clearance.	See your authorized servicing dealer or engine distributor.
	Dirty or faulty injection nozzles.	Have authorized servicing dealer or engine distributor check injectors.
	Injection pump out of time.	See your authorized servicing dealer or engine distributor.
	Turbocharger not functioning. (Turbocharged engines only.)	See your authorized servicing dealer or engine distributor.
	Leaking exhaust manifold gasket.	See your authorized servicing dealer or engine distributor.
	Defective aneroid control line.	See your authorized servicing dealer or engine distributor.
	Restricted fuel hose.	Clean or replace fuel hose.
Engine idles poorly	Low fast idle speed.	See your authorized servicing dealer or engine distributor.
	Poor fuel quality	Drain fuel and replace with quality fuel of the proper grade.
	Engine out of time	See your authorized servicing dealer or engine distributor.
	Air leak on suction side of air intake system.	Check hose and pipe connections for tightness; repair as required.

Continued on next page

RG.RG34/10.5092 -19-30JAN98-4/8

Troubleshooting

Symptom	Problem	Solution
Low oil pressure	Low oil level.	Add oil.
	Improper type of oil.	Drain, fill crankcase with oil of proper viscosity and quality.
High oil consumption	Crankcase oil too light.	Use proper viscosity oil.
	Oil leaks.	Check for leaks in lines, gaskets, and drain plug.
	Restricted crankcase vent tube.	Clean vent tube.
	Defective turbocharger.	See your authorized servicing dealer or engine distributor.
Engine emits white exhaust smoke	Improper type of fuel.	Use proper fuel.
	Low engine temperature.	Warm up engine to normal operating temperature.
	Defective thermostat.	Remove and check thermostat.
	Defective injection nozzles.	See your authorized servicing dealer or engine distributor.
	Engine out of time (retarded).	See your authorized servicing dealer or engine distributor.
	Coolant entering combustion chamber (failed cylinder head gasket or cracked cylinder head)	Repair or replace as required. See your John Deere engine distributor or servicing dealer.
	Engine compression too low	Determine cause of low compression and repair as required. See your John Deere engine distributor or servicing dealer.

Continued on next page

RG, RG34710, 5092 -19-30 JAN98-5/8

Troubleshooting

Symptom	Problem	Solution
Engine emits black or gray exhaust smoke	Improper type of fuel.	Use proper fuel.
	Clogged or dirty air cleaner.	Service air cleaner.
	Engine overloaded.	Reduce load.
	Injection nozzles dirty.	See your authorized servicing dealer or engine distributor.
	Engine out of time.	See your authorized servicing dealer or engine distributor.
	Turbocharger not functioning.	See your authorized servicing dealer or engine distributor.
	Engine burning oil	See LUBRICATION SYSTEM TROUBLESHOOTING, later in this section.
	Defective muffler/exhaust piping (causing back-pressure)	Replace muffler or defective piping.
Engine Overheats	Engine overloaded.	Reduce load.
	Low coolant level.	Fill radiator to proper level, check radiator and hoses for loose connections or leaks.
	Faulty radiator cap.	Have technician check.
	Loose or defective fan belts.	Adjust belt tension. Replace as required.
	Low engine oil level.	Check oil level. Add oil as required.
	Cooling system needs flushing.	Flush cooling system.
	Defective thermostat.	Remove and check thermostat.
	Defective temperature gauge or sender.	Check coolant temperature with thermometer and replace, if necessary.
	Incorrect grade of fuel.	Use correct grade of fuel.

Continued on next page

RG, RG34710, 5092 -19-30JAN98-6/8

Troubleshooting

Symptom	Problem	Solution
High fuel consumption	Improper type of fuel.	Use proper type of fuel.
	Clogged or dirty air cleaner.	Service air cleaner.
	Engine overloaded.	Reduce load.
	Improper valve clearance.	See your authorized servicing dealer or engine distributor.
	Injection nozzles dirty.	See your authorized servicing dealer or engine distributor.
	Engine out of time.	See your authorized servicing dealer or engine distributor.
	Defective turbocharger.	See your authorized servicing dealer or engine distributor.
	Low engine temperature.	Check thermostat.
Compression too low.	Determine cause of low compression and repair as needed.	
Fuel in Oil	Cracked cylinder head	Locate crack, repair/replace components as required. See your John Deere engine distributor or servicing dealer.

Continued on next page

RG.RG34710.5092 -19-30JAN98-7/8

Troubleshooting

Symptom	Problem	Solution
Abnormal Engine Noise	Worn main or connecting rod bearings	Determine bearing clearance. See your John Deere engine distributor or servicing dealer.
	Excessive crankshaft end play	Check crankshaft end play. See your John Deere engine distributor or servicing dealer.
	Loose main bearing caps	Check bearing clearance; replace bearings and bearing cap screws as required. See your John Deere engine distributor or servicing dealer.
	Worn connecting rod bushings and piston pins	Inspect piston pins and bushings. See your John Deere engine distributor or servicing dealer.
	Scored pistons	Inspect pistons. See your John Deere engine distributor or servicing dealer.
	Worn timing gears or excess backlash	Check timing gear back lash. See your John Deere engine distributor or servicing dealer.
	Excessive valve clearance	Check and adjust valve clearance. See your John Deere engine distributor or servicing dealer.
	Worn camshaft lobes	Inspect camshaft. See your John Deere engine distributor or servicing dealer.
	Worn rocker arm shaft(s)	Inspect rocker arm shafts. See your John Deere engine distributor or servicing dealer.
	Insufficient engine lubrication	See LUBRICATION SYSTEM TROUBLESHOOTING, later in this section.
Turbocharger noise	See AIR INTAKE SYSTEM TROUBLESHOOTING, later in this section.	

ELECTRICAL TROUBLESHOOTING

Symptom	Problem	Solution
Undercharged system	Excessive electrical load from added accessories.	Remove accessories or install higher output alternator.
	Excessive engine idling.	Increase engine rpm when heavy electrical load is used.
	Poor electrical connections on battery, ground strap, starter, or alternator.	Inspect, clean and tighten as necessary.
	Defective battery.	Test battery.
Battery used too much water	Defective alternator.	Test charging system.
	Cracked battery case.	Check for moisture and replace as necessary.
	Defective battery.	Test battery.
Batteries will not charge	Battery charging rate too high.	Test charging system.
	Loose or corroded connections.	Clean and tighten connections.
	Sulfated or worn-out batteries.	See your authorized servicing dealer or engine distributor.
Starter will not crank	Loose or defective alternator belt.	Adjust belt tension or replace belts.
	PTO engaged.	Disengage PTO.
Starter will not crank	Loose or corroded connections.	Clean and tighten loose connections.
	Low battery output voltage.	See your authorized servicing dealer or engine distributor.
	Faulty start circuit relay.	See your authorized servicing dealer or engine distributor.
	Blown fuse.	Replace fuse.

Continued on next page

RG, RG34710, 5093 -19-30JAN98-1/2

Troubleshooting

Symptom	Problem	Solution
Starter cranks slowly	Low battery output.	See your authorized servicing dealer or engine distributor.
	Crankcase oil too heavy.	Use proper viscosity oil.
	Loose or corroded connections.	Clean and tighten loose connections.
Entire electrical system does not function	Faulty battery connection.	Clean and tighten connections.
	Sulfated or worn-out batteries.	See your authorized servicing dealer or engine distributor.
	Blown fuse.	Replace fuse.

RG, RG34710, 5093 -19-30JAN98-2/2

LUBRICATION SYSTEM TROUBLESHOOTING

Symptom	Problem	Solution
Low Oil Pressure	Low crankcase oil level	Fill crankcase to proper oil level.
	Clogged oil cooler or filter	Remove and inspect oil cooler. See your John Deere engine distributor or servicing dealer.
	Excessive oil temperature	Remove and inspect oil cooler. See your John Deere engine distributor or servicing dealer.
	Defective oil pump	Remove and inspect oil pump. See your John Deere engine distributor or servicing dealer.
	Incorrect oil	Drain crankcase and refill with correct oil.
	Oil pressure regulating valve failure	Remove and inspect oil pressure regulating valve. See your John Deere engine distributor or servicing dealer.
	Clogged oil pump screen or cracked pick-up tube	Remove oil pan and clean screen/replace pick-up tube.
High Oil Pressure	Excessive main or connecting rod bearing clearance	Determine bearing clearance. See your John Deere engine distributor or servicing dealer.
	Improper oil classification	Drain crankcase and refill with correct oil.
	Oil pressure regulating valve failure	Remove and inspect oil pressure regulating valve. See your John Deere engine distributor or servicing dealer.
	Stuck or damaged filter bypass valve	Remove and inspect filter bypass valve. See your John Deere engine distributor or servicing dealer.
	Stuck or damaged oil cooler bypass valve	Remove and inspect oil cooler bypass valve. See your John Deere engine distributor or servicing dealer.

Troubleshooting

Symptom	Problem	Solution
Excessive Oil Consumption	Too low viscosity crankcase oil	Drain crankcase and refill with correct viscosity oil.
	Crankcase oil level too high	Drain oil until oil level is correct.
	External oil leak(s)	Determine source of oil leak(s) and repair as required.
	Oil control rings worn or broken	Replace piston rings. See your John Deere engine distributor or servicing dealer.
	Scored cylinder liners or pistons	Remove and inspect cylinders and liners; replace as required. See your John Deere engine distributor or servicing dealer.
	Worn valve guides or stems	Inspect and measure valve stems and valve guides; repair as required. See your John Deere engine distributor or servicing dealer.
	Excessive oil pressure	See High Oil Pressure.
	Piston ring grooves excessively worn	Remove and inspect pistons. See your John Deere engine distributor or servicing dealer.
	Piston rings sticking in ring grooves	Remove and inspect pistons. See your John Deere engine distributor or servicing dealer.
	Insufficient piston ring tension	Remove and inspect pistons. See your John Deere engine distributor or servicing dealer.
	Piston ring gaps not staggered	Remove and inspect pistons. See your John Deere engine distributor or servicing dealer.
	Front and/or rear crankshaft oil seal faulty	Replace oil seals. See your John Deere engine distributor or servicing dealer.

Continued on next page

RG, RG34710, 7600 -19-38JUN97-2/3

Troubleshooting

Symptom	Problem	Solution
		See LOW PRESSURE SYSTEM-FUEL PRESSURE LOW TROUBLESHOOTING earlier in this section.
Fuel in Oil		See FUEL IN OIL TROUBLESHOOTING earlier in this section.
Coolant in Oil		See COOLING SYSTEM TROUBLESHOOTING later in this section.

RG, RG34710, 7600 -19-30JUN97-3/3

COOLING SYSTEM TROUBLESHOOTING

Symptom	Problem	Solution
Engine Overheats	Lack of coolant in cooling system	Fill cooling system to proper level.
	Radiator core dirty	Clean radiator as required.
	Engine overloaded	Reduce engine load.
	Too low crankcase oil level	Fill crankcase to proper oil level.
	Loose or defective fan belt	Replace fan belt as required. Check belt tensioner. (See Lubrication and Maintenance 600 Hour/12 Month Section.)
	Defective thermostat	Test thermostat opening temperature; replace thermostat as required.
	Damaged cylinder head gasket	Replace cylinder head gasket. See your John Deere engine distributor or servicing dealer.
	Defective coolant pump	Replace coolant pump. See your John Deere engine distributor or servicing dealer.
	Defective radiator cap	Replace radiator cap as required.

Continued on next page

RG, RG34710, 7601 -19-30JUN97-1/2

Troubleshooting

Symptom	Problem	Solution
Coolant in Oil	Cylinder head gasket defective	Replace cylinder head gasket. See your John Deere engine distributor or servicing dealer.
	Cylinder head or block cracked	Locate crack, repair/replace components as required.
	Cylinder liner seals leaking	Remove and inspect cylinder liners. See your John Deere engine distributor or servicing dealer.
	Leaking oil cooler	Pressure test oil cooler; repair/replace as required. See your John Deere engine distributor or servicing dealer.
	Defective oil cooler O-rings	Remove and inspect oil cooler O-rings; replace as required. See your John Deere engine distributor or servicing dealer.
	Faulty coolant pump seal; weep hole plugged; coolant leaking through bearing	Replace coolant pump seals. See your John Deere engine distributor or servicing dealer.
Coolant Temperature Below Normal	Defective thermostat(s)	Test thermostats; replace thermostats as required.

RG.RG34710,7601 -19-30JUN97-2/2

AIR INTAKE SYSTEM TROUBLESHOOTING

If turbocharger requires replacement, determine what caused the failure of the defective unit, and correct the condition. This will prevent an immediate repeat failure of the replacement unit.

NOTE: Turbochargers are equipped on 3029T engines only.

Symptom	Problem	Solution
Hard to Start or Will Not Start		See ENGINE TROUBLESHOOTING earlier in this section.
Engine Misfiring or Runs Irregularly		See ENGINE TROUBLESHOOTING earlier in this section.
Black or Grey Exhaust Smoke		See ENGINE TROUBLESHOOTING earlier in this section.
Lack of Engine Power		See ENGINE TROUBLESHOOTING earlier in this section.
Turbocharger "Screams"	Air leak in intake manifold.	Check intake manifold gasket and manifold; repair as required. See your John Deere engine distributor or servicing dealer.
Turbocharger Noise or Vibration	Bearings not lubricated (insufficient oil pressure)	Determine cause of lack of lubrication; repair as required. See your John Deere engine distributor or servicing dealer.
	Air leak in engine intake or exhaust manifold	Check intake and exhaust manifold gaskets and manifolds; repair as required. See your John Deere engine distributor or servicing dealer.
	Improper clearance between turbine wheel and turbine housing	Inspect turbocharger; repair/replace as required. See your John Deere engine distributor or servicing dealer.
	Broken blades (or other wheel failures)	Inspect turbocharger; repair/replace as required. See your John Deere engine distributor or servicing dealer.

NOTE: Do not confuse the whine heard during run down with noise which indicates a bearing failure.

Troubleshooting

Symptom	Problem	Solution
Oil on Turbocharger Compressor Wheel or in Compressor Housing (Oil Being Pushed or Pulled Through Center Housing)	Excessive crankcase pressure.	Determine cause of excessive crankcase pressure; repair as required. See your John Deere engine distributor or servicing dealer.
	Air intake restriction	Determine cause of intake restriction; repair as required. See your John Deere engine distributor or servicing dealer.
	Drain tube restriction	Determine cause of drain tube restriction; repair as required. See your John Deere engine distributor or servicing dealer.
Oil in Intake Manifold or Dripping from Turbocharger Housing	Excessive crankcase pressure	Determine cause of excessive crankcase pressure; repair as required. See your John Deere engine distributor or servicing dealer.
	Air intake restriction	Determine cause of intake restriction; repair as required. See your John Deere engine distributor or servicing dealer.
	Drain tube restriction	Determine cause of drain tube restriction; repair as required. See your John Deere engine distributor or servicing dealer.
	Damaged or worn housing bearings	Inspect turbocharger; repair/replace as required. See your John Deere engine distributor or servicing dealer.
	Imbalance of rotating assembly	Inspect turbocharger; repair/replace as required. See your John Deere engine distributor or servicing dealer.
	Damage to turbine or compressor wheel or blade	Inspect turbocharger; repair/replace as required. See your John Deere engine distributor or servicing dealer.
	Dirt or carbon build-up on wheel or blade	Inspect turbocharger; repair/replace as required. See your John Deere engine distributor or servicing dealer.

Continued on next page

RG.RG34/10.7602 -19-30JUN97-2/3

Troubleshooting

Symptom	Problem	Solution
	Bearing wear	Inspect turbocharger; repair/replace as required. See your John Deere engine distributor or servicing dealer.
	Oil starvation or insufficient lubrication	Determine cause of lack of lubrication; repair as required. See your John Deere engine distributor or servicing dealer.
	Shaft seals worn	Inspect turbocharger; repair/replace as required. See your John Deere engine distributor or servicing dealer.
Turbocharger Turbine Wheel Drag	Carbon build-up behind turbine wheel caused by coked oil or combustion deposits	Inspect turbocharger; repair/replace as required. See your John Deere engine distributor or servicing dealer.
	Dirt build-up behind compressor wheel caused by air intake leaks.	Inspect turbocharger; repair/replace as required. See your John Deere engine distributor or servicing dealer.
	Bearing seizure or dirty, worn bearings	Inspect turbocharger; repair/replace as required. See your John Deere engine distributor or servicing dealer.

RG, RG34710, 7602 -19-30JUN97-3/3

Storage

ENGINE STORAGE GUIDELINES

1. John Deere engines can be stored outside for up to three (3) months with no long term preparation IF COVERED BY WATERPROOF COVERING.
2. John Deere engines can be stored in a standard overseas shipping container for up to three (3) months with no long term preparation.
3. John Deere engines can be stored inside, warehoused, for up to six (6) months with no long term preparation.
4. John Deere engines expected to be stored more than six (6) months, long term storage preparation **MUST BE** taken. (See PREPARING ENGINE FOR LONG TERM STORAGE, later in this section.)
5. For John Deere engines not yet installed in machines, run a line from a container of AR41937 Nucle Oil to the fuel transfer pump intake, and another line from the fuel return manifold to the tank, so that Nucle Oil is circulated through the injection system during cranking.

RG, RG34710, 5094 -19-30JAN98-1/1

USE AR41785 ENGINE STORAGE KIT

IMPORTANT: Inhibitors can easily change to gas.
Seal or tape each opening immediately
after adding inhibitor.

See your John Deere servicing dealer or engine distributor for an AR41785 Engine Storage Kit. Closely follow instructions provided with this kit.



AR41785 Engine Storage Kit

RG, RG34710, 5095 -19-30JAN98-1/1

PREPARING ENGINE FOR LONG TERM STORAGE

The following storage preparations are good for long term engine storage up to one year. After that, the engine should be started, warmed up, and retreated for an extended storage period.

IMPORTANT: Any time your engine will not be used for over six (6) months, the following recommendations for storing it and removing it from storage will help to minimize corrosion and deterioration. Use the AR41785 Engine Storage Kit. Follow recommended service procedure included with storage kit.

1. Change engine oil and replace filter. Used oil will not give adequate protection. (See CHANGING ENGINE OIL AND FILTER in Lubrication and Maintenance/250 Hour Section.)
2. Service air cleaner. (See REPLACING AIR CLEANER FILTER ELEMENT in Service As Required Section.)
3. Draining and flushing of cooling system is not necessary if engine is to be stored only for several months. However, for extended storage periods of a year or longer, it is recommended that the cooling system be drained, flushed, and refilled. Refill with appropriate coolant. (See RECOMMENDED ENGINE COOLANT in Fuels, Lubricants, and Coolant Section and ADDING COOLANT in Service As Required Section.)
4. Drain fuel tank and add 30 ml (1 oz) of inhibitor to the fuel tank for each 15 L (4 U.S. gal) of tank capacity. Completely drain fuel filter and close fuel valve, if equipped.
5. Add 30 ml (1 oz) of inhibitor to the engine crankcase for each 0.95 L (1 qt) of crankcase oil.
6. Disconnect air intake piping from the manifold. Pour 90 ml (3 oz) of inhibitor into intake system and reconnect the piping.
7. Crank the engine several revolutions with starter (do not allow the engine to start).
8. Remove fan/alternator belt, if desired.
9. Remove and clean batteries. Store them in a cool, dry place and keep them fully charged.
10. Disengage the PTO clutch.
11. Clean the exterior of the engine with salt-free water and touchup any scratched or chipped painted surfaces with a good quality paint.
12. Coat all exposed (machined) metal surfaces with grease or corrosion inhibitor if not feasible to paint.
13. Seal all openings on engine with plastic bags and tape supplied in storage kit. Follow instructions supplied in kit.
14. Store the engine in a dry protected place. If engine must be stored outside, cover it with a waterproof canvas or other suitable protective material and use a strong waterproof tape.

RG.RG34710,5096 -19-30JAN98-1/1

REMOVING ENGINE FROM LONG TERM STORAGE

Refer to the appropriate section for detailed services listed below or have your authorized servicing dealer or engine distributor perform services that you may not be familiar with.

1. Remove all protective coverings from engine. Unseal all openings in engine and remove covering from electrical systems.
2. Remove the batteries from storage. Install batteries (fully charged) and connect the terminals.
3. Install fan/alternator belt if removed.
4. Fill fuel tank.
5. Perform all appropriate prestarting checks. (See DAILY PRESTARTING CHECKS in Lubrication and Maintenance/Daily Section.)
6. Crank engine for 20 seconds with starter (do not allow the engine to start). Wait 2 minutes and crank engine an additional 20 seconds to assure bearing surfaces are adequately lubricated.
7. Start engine and run at low idle and no load for several minutes. Warm up carefully and check all gauges before placing engine under load.
8. On the first day of operation after storage, check overall engine for leaks and check all gauges for correct operation.

IMPORTANT: DO NOT operate starter more than 30 seconds at a time. Wait at least 2 minutes for starter to cool before trying again.

RG.RG34710.5087 -19-30JAN98-1/1

Specifications

GENERAL OEM ENGINE SPECIFICATIONS

ITEM	3029DF120	3029DF150	3029DF160	3029DF180	3029TF120	3029TF150	3029TF160	3029TF180
Number of Cylinders	3	3	3	3	3	3	3	3
Fuel	Diesel	Diesel	Diesel	Diesel	Diesel	Diesel	Diesel	Diesel
Bore	106.5 mm (4.19 in.)	106.5 mm (4.19 in.)	106.5 mm (4.19 in.)	106.5 mm (4.19 in.)	106.5 mm (4.19 in.)	106.5 mm (4.19 in.)	106.5 mm (4.19 in.)	106.5 mm (4.19 in.)
Stroke	110 mm (4.33 in.)	110 mm (4.33 in.)	110 mm (4.33 in.)	110 mm (4.33 in.)	110 mm (4.33 in.)	110 mm (4.33 in.)	110 mm (4.33 in.)	110 mm (4.33 in.)
Displacement	2.9 L (179 cu in.)	2.9 L (179 cu in.)	2.9 L (179 cu in.)	2.9 L (179 cu in.)	2.9 L (179 cu in.)	2.9 L (179 cu in.)	2.9 L (179 cu in.)	2.9 L (179 cu in.)
Compression Ratio	17.8:1	17.8:1	17.8:1	17.8:1	17.8:1	17.8:1	17.8:1	17.8:1
Physical Dimensions:								
Width	519 mm (20.4 in.)	519 mm (20.4 in.)	528 mm (20.8 in.)	528 mm (20.8 in.)	519 mm (20.4 in.)	519 mm (20.4 in.)	528 mm (20.8 in.)	528 mm (20.8 in.)
Height	819 mm (32.2 in.)	819 mm (32.2 in.)	819 mm (32.2 in.)	819 mm (32.2 in.)	928 mm (36.5 in.)	928 mm (36.5 in.)	928 mm (36.5 in.)	928 mm (36.5 in.)
Length	716 mm (28.2 in.)	716 mm (28.2 in.)	716 mm (28.2 in.)	716 mm (28.2 in.)	716 mm (28.2 in.)	716 mm (28.2 in.)	716 mm (28.2 in.)	716 mm (28.2 in.)
Basic Dry Weight	316 kg (696 lb)	316 kg (696 lb)	317 kg (698 lb)	317 kg (698 lb)	328 kg (722 lb)	328 kg (722 lb)	329 kg (724 lb)	329 kg (724 lb)

NOTE: Engine models listed above with numbers ending in "120" and "160" are emission non-certified. Engines with model numbers ending in "150" and "180" are emission certified, as explained later in this manual.

RG, RG34710, 5098 -19-30JAN98-1/1

Specifications

FUEL INJECTION PUMP SPECIFICATIONS¹—EMISSION CERTIFIED ENGINES

ENGINE MODEL	OPTION CODES	FUEL INJECTION PUMP PART NUMBER	POWER RATING @RATED SPEED ² kW (hp)	RATED SPEED ³ (rpm)	SLOW IDLE (rpm)	FAST IDLE ⁴ (rpm)
CD3029DF150	16DP	RE502217	43 (58)	2500	850	2700
	16EG	RE501983	43 (58)	2500	850	2700
	16EQ	RE502509	43 (58)	2500	1700	2700
	16HW	RE501259	36 (48)	2500	850	2700
	16PN	RE502217	43 (58)	2500	850	2700
CD3029DF151	16DZ	RE501258	43 (58)	2500	850	2700
CD3029DF152	16KZ	RE502217	43 (58)	2500	850	2700
CD3029DF180	16DR	RE502217	43 (58)	2500	850	2700
	16EH	RE501983	43 (58)	2500	850	2700
	16NP	RE502217	43 (58)	2500	850	2700
CD3029TF150	16DE	RE502218	59 (79)	2500	850	2700
	16DF	RE502238	52 (70)	2500	850	2700
CD3029TF152	16EA	RE501218	59 (79)	2500	850	2700
CD3029TF180	16DG	RE502218	59 (79)	2500	850	2700
	16DH	RE502238	52 (70)	2500	850	2700
	16EL	RE501985	59 (79)	2500	850	2700
	16EM	RE501986	52 (70)	2500	850	2700
PE3029DF150	16DP	RE502217	43 (58)	2500	850	2700
	16EG	RE501983	43 (58)	2500	850	2700
	16EQ	RE502182	43 (58)	2500	850	2700
	16HW	RE501259	36 (49)	2500	850	2700
	16PH	RE501259	36 (49)	2500	850	2700
PE3029TF150	16DE	RE502218	59 (79)	2500	850	2700
	16DF	RE502238	52 (69)	2500	850	2700
	16EJ	RE501985	59 (79)	2500	850	2700
	16EK	RE502986	52 (69)	2500	850	2700
	16TR	RE506877	48 (64)	1800	—	1890
	16TS	RE506878	48 (64)	1800	—	1890

¹Power ratings are for a bare engine without the drag effect of accessories like fans, transmission, and auxiliary drives.

²Generator set engines (3-5% governor) usually run at 1500 rpm (50 Hz) or 1800 (60 Hz) when operating under load depending on cycles of AC current.

³For engines with standard governor, fast idle is 7-10% above rated speed. For engines with generator set governors, fast idle is 3-5% above rated speed.

⁴Engine speeds listed are preset to factory specification. Slow idle speed may be reset depending upon specific vehicle application requirements. Refer to your machine operator's manual for engine speeds that are different from those preset at the factory.

FUEL INJECTION PUMP SPECIFICATIONS¹—EMISSION NON-CERTIFIED ENGINES

ENGINE MODEL	OPTION CODES	FUEL INJECTION PUMP PART NUMBER	POWER RATING @RATED SPEED ^a kW (hp)	RATED SPEED ^b (rpm)	SLOW IDLE (rpm)	FAST IDLE ^c (rpm)
CD3029DF120	1602	RE53785	43 (58)	2500	850	2700
	1603	RE53786	35 (47)	1800	—	1890
	1641	RE53787	31 (41)	1500	—	1560
	1642	RE67271	43 (58)	2500	850	2700
	1644	RE41939	34 (46)	1800	—	1890
	1648	RE64242	30 (40)	1500	—	1560
	1650	RE41938	43 (58)	2500	850	2700
	1655	RE53785	43 (58)	2500	850	2700
CD3029DF121	1602	RE53785	43 (58)	2500	800	2700
	1650	RE41938	43 (58)	2500	800	2700
CD3029DF122	1603	RE53786	35 (47)	1800	—	1890
	1641	RE53787	31 (41)	1500	—	1560
	1644	RE41939	34 (46)	1800	—	1890
	1648	RE64272	30 (40)	1500	—	1560
CD3029DF123	16BS	RE53785	43 (58)	2500	800	2700
CD3029DF124	1641	RE53787	31 (41)	1500	—	1560
CD3029DF160	1602	RE53785	43 (58)	2500	850	2700
	1632	RE51940	37 (50)	2200	850	2400
	1643	RE67271	43 (58)	2500	850	2700
	1650	RE41938	43 (58)	2500	850	2700
CD3029DF162	16YG	RE51940	37 (50)	2200	800	2400
CD3029DF163	1654	RE63523	41 (55)	2400	800	2600
CD3029DF164	16DV	RE53785	43 (58)	2500	850	2700
CD3029DF165	16TH	RE53785	43 (48)	2500	850	2700
CD3029TF120	1602	RE53783	59 (79)	2500	800	2700
	1632	RE58903	59 (79)	2500	800	2700
	1640	RE53958	59 (79)	2500	800	2700
CD3029TF121	1602	RE53783	59 (79)	2500	800	2700
	1632	RE58903	59 (79)	2500	800	2700

^aPower ratings are for a bare engine without the drag effect of accessories like fans, transmission, and auxiliary drives.

^bGenerator set engines (3-5% governor) usually run at 1500 rpm (50 Hz) or 1800 (60 Hz) when operating under load depending on cycles of AC current.

^cFor engines with standard governor, fast idle is 7-10% above rated speed. For engines with generator set governors, fast idle is 3-5% above rated speed.

¹Engine speeds listed are preset to factory specification. Slow idle speed may be reset depending upon specific vehicle application requirements. Refer to your machine operator's manual for engine speeds that are different from those preset at the factory.

Specifications

	1640	RE53958	59 (79)	2500	800	2700
CD3029TF123	16BT	RE53783	59 (79)	2500	800	2700
CD3029TF160	1602	RE53783	59 (79)	2500	800	2700
	1632	RE58903	59 (79)	2500	800	2700
	1633	RE51979	46 (62)	2200	800	2400
	1634	RE53783	59 (79)	2500	800	2700
	1640	RE53958	59 (79)	2500	800	2700
CD3029TF161	16EV	RE53958	59 (79)	2500	800	2700
CD3029TF162	1633	RE51979	46 (62)	2200	800	2700
CD3029TF163	1602	RE53783	59 (79)	2500	800	2700
PE3029DF120	1602	RE53785	43 (58)	2500	850	2700
	1603	RE53786	35 (47)	1800	—	1890
	1641	RE64241	43 (58)	2500	850	2700
	1642	RE67271	43 (58)	2500	850	2700
	1644	RE41939	35 (47)	1800	—	1890
	1648	RE64242	31 (41)	1500	—	1560
	1650	RE41938	43 (58)	2500	850	2700
	1655	RE53785	43 (58)	2500	850	2700
	PE3029TF120	16TT	RE506879	42 (56)	1500	—
16TU		RE506880	42 (56)	1500	—	1560
1602		RE53783	59 (79)	2500	850	2700
1632		RE58903	59 (79)	2500	850	2700
1640		RE53958	59 (79)	2500	850	2700

OUOD002.000002A -19-18JAN01-2/2

ENGINE CRANKCASE OIL FILL QUANTITIES

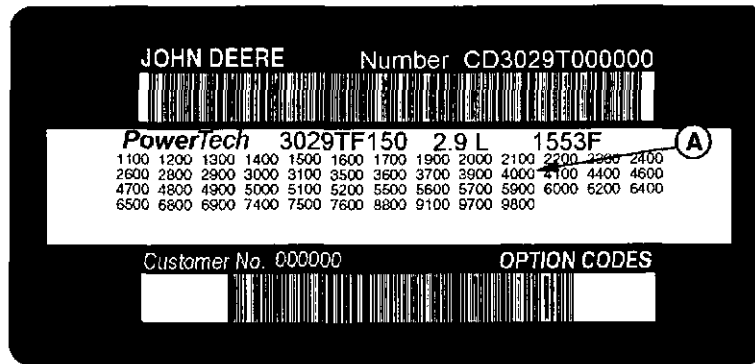

Option Code Label (3029TF150 Shown)

A—Dipstick Tube Option (used to determine crankcase oil fill quantity)

To determine the option code for the oil fill quantity of your engine, refer to the engine option code label affixed to the rocker arm cover (shown above). The first two digits of the code (40) (see A) identify the dipstick tube group. The last two digits of the code identify the specific dipstick and tube assembly on your engine.

Listed on next page are engine crankcase oil fill quantities:

Continued on next page

RG.RG34710,5100 -19-30JAN98-1/3

Specifications

Engine Model	Dipstick Tube Option Code(s)	Crankcase Oil Capacity
CD3029DF120	4002, 4003, 4004, 4005 4006	6.0 L (6.5 qt) 8.0 L (8.5 qt)
CD3029DF121	4004, 4005	6.0 L (6.5 qt)
CD3029DF122	4004	6.0 L (6.5 qt)
CD3029DF123	4004	6.0 L (6.5 qt)
CD3029DF124	4004	6.0 L (6.5 qt)
CD3029DF150	4004, 4005, 4024 4022	6.0 L (6.5 qt) 7.0 L (7.5 qt)
CD3029DF151	4004	6.0 L (6.5 qt)
CD3029DF152	4004	6.0 L (6.5 qt)
CD3029DF160	4024 4022 4033	6.0 L (6.5 qt) 7.0 L (7.5 qt) 8.0 L (8.5 qt)
CD3029DF161	4024	6.0 L (6.5 qt)
CD3029DF162	4006	8.0 L (8.5 qt)
CD3029DF163	4024	6.0 L (6.5 qt)
CD3029DF164	4033	8.0 L (8.5 qt)
CD3029DF165	4024	6.0 L (6.5 qt)
CD3029DF180	4022 4033	7.0 L (7.5 qt) 8.0 L (8.5 qt)
CD3029TF120	4006, 4025 4023 4024	8.0 L (8.5 qt) 9.0 L (9.5 qt) 6.0 L (6.5 qt)
CD3029TF121	4006, 4024	8.0 L (8.5 qt)
CD3029TF123	4006	8.0 L (8.5 qt)
CD3029TF150	4006, 4025 4023 4024	8.0 L (8.5 qt) 9.0 L (9.5 qt) 6.0 L (6.5 qt)
CD3029TF152	4006	8.0 L (8.5 qt)
CD3029TF160	4024 4026 4033	6.0 L (6.5 qt) 8.5 L (9.0 qt) 8.0 L (8.5 qt)
CD3029TF161	4024	6.0 L (6.5 qt)
CD3029TF162	4006 4026	8.0 L (8.5 qt) 8.5 L (9.0 qt)

Continued on next page

RG, RG34710, 5100 -19-30JAN98-2/3

Specifications

Engine Model	Dipstick Tube Option Code(s)	Crankcase Oil Capacity
CD3029TF163	4024	6.0 L (6.5 qt)
CD3029TF180	4023	9.0 L (9.5 qt)
	4024	6.0 L (6.5 qt)
	4026	8.5 L (9.0 qt)
	4033	8.0 L (8.5 qt)
PE3029DF120	4004, 4005	6.0 L (6.5 qt)
	4006	8.0 L (8.5 qt)
	4022	7.0 L (7.5 qt)
PE3029DF150	4004	6.0 L (6.5 qt)
PE3029TF120	4025	8.0 L (8.5 qt)
PE3029TF150	4006, 4025	8.0 L (8.5 qt)
	4023	9.0 L (9.5 qt)

Crankcase oil capacity may vary slightly from amount shown. ALWAYS fill crankcase to full mark or within

crosshatch, or between arrows on dipstick, whichever is present. DO NOT overfill.

RG.RG34710.5100 -19-30JAN98-3/3

UNIFIED INCH BOLT AND CAP SCREW TORQUE VALUES

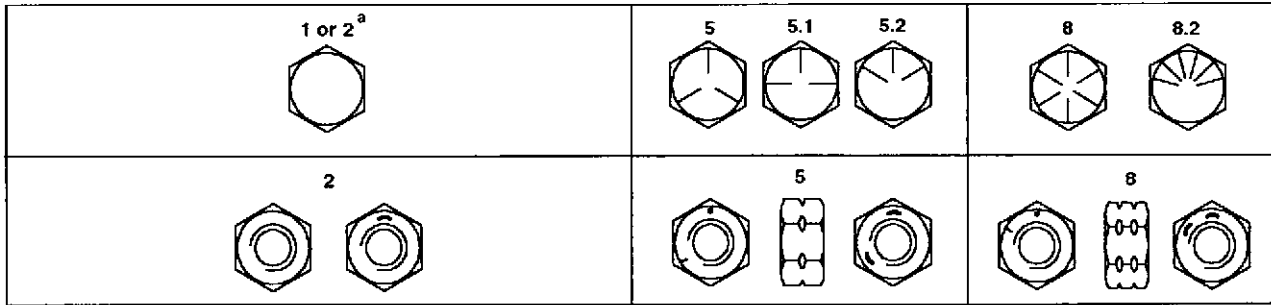

Top, SAE Grade and Head Markings; Bottom, SAE Grade and Nut Markings

Size	Grade 1 (No Mark)		Grade 2 ^a (No Mark)		Grade 5, 5.1 or 5.2		Grade 8 or 8.2	
	Lubricated ^b N·m(lb-ft)	Dry ^c N·m(lb-ft)	Lubricated ^b N·m(lb-ft)	Dry ^c N·m(lb-ft)	Lubricated ^b N·m(lb-ft)	Dry ^c N·m(lb-ft)	Lubricated ^b N·m(lb-ft)	Dry ^c N·m(lb-ft)
1/4	3.8 (2.8)	4.7 (3.5)	6 (4.4)	7.5 (5.5)	9.5 (7)	12 (9)	13.5 (10)	17 (12.5)
5/16	7.7 (5.7)	9.8 (7.2)	12 (9)	15.5 (11.5)	19.5 (14.5)	25 (18.5)	28 (20.5)	35 (26)
3/8	13.5 (10)	17.5 (13)	22 (16)	27.5 (20)	35 (26)	44 (32.5)	49 (36)	63 (46)
7/16	22 (16)	28 (20.5)	35 (26)	44 (32.5)	56 (41)	70 (52)	80 (59)	100 (74)
1/2	34 (25)	42 (31)	53 (39)	67 (49)	85 (63)	110 (80)	120 (88)	155 (115)
9/16	48 (35.5)	60 (45)	76 (56)	95 (70)	125 (92)	155 (115)	175 (130)	220 (165)
5/8	67 (49)	85 (63)	105 (77)	135 (100)	170 (125)	215 (160)	240 (175)	305 (225)
3/4	120 (88)	150 (110)	190 (140)	240 (175)	300 (220)	380 (280)	425 (315)	540 (400)
7/8	190 (140)	240 (175)	190 (140)	240 (175)	490 (360)	615 (455)	690 (510)	870 (640)
1	285 (210)	360 (265)	285 (210)	360 (265)	730 (540)	920 (680)	1030 (760)	1300 (960)
1-1/8	400 (300)	510 (375)	400 (300)	510 (375)	910 (670)	1150 (850)	1450 (1075)	1850 (1350)
1-1/4	570 (420)	725 (535)	570 (420)	725 (535)	1280 (945)	1630 (1200)	2050 (1500)	2600 (1920)
1-3/8	750 (550)	950 (700)	750 (550)	950 (700)	1700 (1250)	2140 (1580)	2700 (2000)	3400 (2500)
1-1/2	990 (730)	1250 (930)	990 (730)	1250 (930)	2250 (1650)	2850 (2100)	3600 (2650)	4550 (3350)

^a Grade 2 applies for hex cap screws (not hex bolts) up to 6 in. (152 mm) long. Grade 1 applies for hex cap screws over 6 in. (152 mm) long, and for all other types of bolts and screws of any length.

^b "Lubricated" means coated with a lubricant such as engine oil, or fasteners with phosphate and oil coatings.

^c "Dry" means plain or zinc plated without any lubrication.

DO NOT use these values if a different torque value or tightening procedure is given for a specific application. Torque values listed are for general use only. Check tightness of fasteners periodically.

Shear bolts are designed to fail under predetermined loads. Always replace shear bolts with identical grade.

Fasteners should be replaced with the same or higher grade. If higher grade fasteners are used, these should only be tightened to the strength of the original.

Make sure fastener threads are clean and that you properly start thread engagement. This will prevent them from failing when tightening.

Tighten plastic insert or crimped steel-type lock nuts to approximately 50 percent of the dry torque shown in the chart, applied to the nut, not to the bolt head. Tighten toolbed or serrated-type lock nuts to the full torque value.

TORQ1A -UN-27SEP99

METRIC BOLT AND CAP SCREW TORQUE VALUES

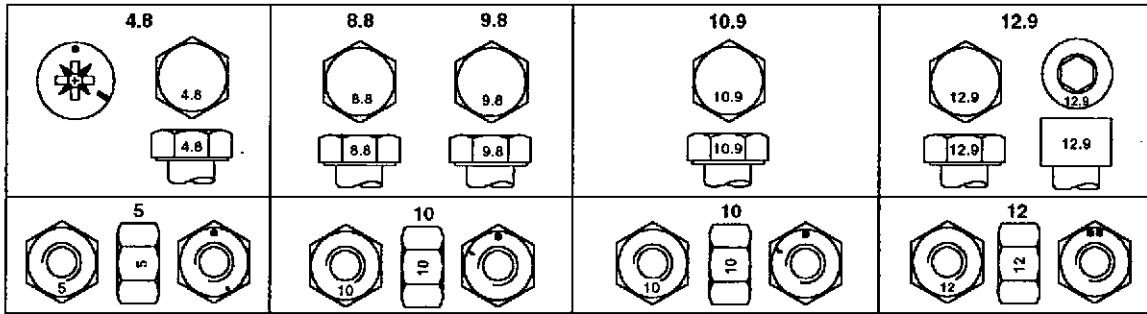

Top, Property Class and Head Markings; Bottom, Property Class and Nut Markings

TORQ2 -UN-07SEP99

Size	Class 4.8		Class 8.8 or 9.8		Class 10.9		Class 12.9	
	Lubricated ^a N·m(lb-ft)	Dry ^b N·m(lb-ft)	Lubricated ^a N·m(lb-ft)	Dry ^b N·m(lb-ft)	Lubricated ^a N·m(lb-ft)	Dry ^b N·m(lb-ft)	Lubricated ^a N·m(lb-ft)	Dry ^b N·m(lb-ft)
M6	4.7 (3.5)	6 (4.4)	9 (6.6)	11.5 (8.5)	13 (9.5)	16.5 (12.2)	15.5 (11.5)	19.5 (14.5)
M8	11.5 (8.5)	14.5 (10.7)	22 (16)	28 (20.5)	32 (23.5)	40 (29.5)	37 (27.5)	47 (35)
M10	23 (17)	29 (21)	43 (32)	55 (40)	63 (46)	80 (59)	75 (55)	95 (70)
M12	40 (29.5)	50 (37)	75 (55)	95 (70)	110 (80)	140 (105)	130 (95)	165 (120)
M14	63 (46)	80 (59)	120 (88)	150 (110)	175 (130)	220 (165)	205 (150)	260 (190)
M16	100 (74)	125 (92)	190 (140)	240 (175)	275 (200)	350 (255)	320 (235)	400 (300)
M18	135 (100)	170 (125)	265 (195)	330 (245)	375 (275)	475 (350)	440 (325)	560 (410)
M20	190 (140)	245 (180)	375 (275)	475 (350)	530 (390)	675 (500)	625 (460)	790 (580)
M22	265 (195)	330 (245)	510 (375)	650 (480)	725 (535)	920 (680)	850 (625)	1080 (800)
M24	330 (245)	425 (315)	650 (480)	820 (600)	920 (680)	1150 (850)	1080 (800)	1350 (1000)
M27	490 (360)	625 (460)	950 (700)	1200 (885)	1350 (1000)	1700 (1250)	1580 (1160)	2000 (1475)
M30	660 (490)	850 (625)	1290 (950)	1630 (1200)	1850 (1350)	2300 (1700)	2140 (1580)	2700 (2000)
M33	900 (665)	1150 (850)	1750 (1300)	2200 (1625)	2500 (1850)	3150 (2325)	2900 (2150)	3700 (2730)
M36	1150 (850)	1450 (1075)	2250 (1650)	2850 (2100)	3200 (2350)	4050 (3000)	3750 (2770)	4750 (3500)

^a "Lubricated" means coated with a lubricant such as engine oil, or fasteners with phosphate and oil coatings.

^b "Dry" means plain or zinc plated without any lubrication.

DO NOT use these values if a different torque value or tightening procedure is given for a specific application. Torque values listed are for general use only. Check tightness of fasteners periodically.

Make sure fastener threads are clean and that you properly start thread engagement. This will prevent them from failing when tightening.

Shear bolts are designed to fail under predetermined loads. Always replace shear bolts with identical property class.

Tighten plastic insert or crimped steel-type lock nuts to approximately 50 percent of the dry torque shown in the chart, applied to the nut, not to the bolt head. Tighten toothed or serrated-type lock nuts to the full torque value.

Fasteners should be replaced with the same or higher property class. If higher property class fasteners are used, these should only be tightened to the strength of the original.

Lubrication and Maintenance Records

USING LUBRICATION AND MAINTENANCE RECORDS

Refer to specific Lubrication and Maintenance Section for detailed service procedures.

1. Keep a record of the number of hours you operate your engine by regular observation of hour meter.
2. Check your record regularly to learn when your engine needs service.
3. DO ALL the services within an interval section. Write the number of hours (from your service records) and the date in the spaces provided. For a complete listing of all items to be performed and the service intervals required, refer to the quick-reference chart near the front of the Lubrication and Maintenance Section.

IMPORTANT: The service recommendations covered in this manual are for the accessories that are provided by John Deere. Follow manufacturer's service recommendations for servicing engine driven equipment not supplied by Deere.

RG, RG34710.5103 -19-30JAN98-1/1

DAILY (PRESTARTING) SERVICE

Check engine oil level.

Check coolant level.

Lubricate PTO release bearing.

Check air cleaner dust unloader valve and air restriction indicator, if equipped.

Visual walkaround inspection.

Check fuel filter.

RG, RG34710.5104 -19-30JAN98-1/1

Lubrication and Maintenance Records

250 HOUR/6 MONTH SERVICE

Check engine mounts.

Lubricate PTO clutch shaft bearings.

Service fire extinguisher.

Service battery.

Change engine oil and filter.

Check fan and alternator belt tension.

Check PTO clutch adjustment.

Hours									
Date									
Hours									
Date									
Hours									
Date									
Hours									
Date									
Hours									
Date									
Hours									
Date									

RG.RG34710,5105 -19-30JAN98-1/1

Lubrication and Maintenance Records

400 HOUR SERVICE

Initial valve clearance adjustment.¹

Hours									
Date									

¹Have your authorized servicing dealer or engine distributor adjust valve clearance after the first 400 hours of operation. Thereafter, have the valve clearance adjusted at 1200 Hour/24 Month intervals.

RG, RG34710, 5107 -19-30JAN98-1/1

600 HOUR/12 MONTH SERVICE

Lubricate PTO clutch internal levers and linkage.

Coolant solution analysis - add SCAs as needed.

Clean crankcase vent tube.

Check air intake hoses, connections, and system.

Pressure test cooling system.

Replace air cleaner element.

Check cooling system.

Hours									
Date									
Hours									
Date									
Hours									
Date									
Hours									
Date									
Hours									
Date									

RG, RG34710, 5108 -19-30JAN98-1/1

Lubrication and Maintenance Records

1200 HOUR/24 MONTH SERVICE

Check and adjust engine valve clearance.

Test thermostat opening temperature.

Adjust variable speed on generator set engines.

Flush and refill cooling system.¹

Hours									
Date									
Hours									
Date									
Hours									
Date									
Hours									
Date									

¹If John Deere COOL-GARD is used, the flushing interval may be extended to 3000 hours or 36 months. If John Deere COOL-GARD is used, and the coolant is tested annually AND additives are replenished by adding supplemental coolant additives (SCA's), the flushing interval may be extended to 5000 hours or 60 months, whichever occurs first.

RG.RG34710,5109 -19-30JAN98-1/1

SERVICE AS REQUIRED

Replace air cleaner elements.

Replace belts.

Bleed fuel system.

Add coolant.

Check fuses.

Inspect PTO clutch.

Hours									
Date									
Hours									
Date									
Hours									
Date									
Hours									
Date									

RG, RG34710, 5110 -19-30JAN98-1/1

Emission System Warranty

EMISSIONS CONTROL SYSTEM CERTIFICATION LABEL

CAUTION: Statutes providing severe penalties for tampering with emissions controls may apply at the user's location.

The emissions warranty described below applies only to those engines marketed by John Deere that have been certified by the United States Environmental Protection Agency (EPA) and/or California Air Resources Board (CARB); and used in the United States and Canada in non-road mobile (self-propelled or portable/transportable¹) equipment. The presence of an emissions label like the one shown signifies that the engine has been certified with the EPA and/or CARB. The EPA and CARB warranties only apply to new engines having the certification label affixed to the engine and sold as stated above in the geographic areas. The presence of an EU number in the third line of the label signifies that the engine has been certified with the European Union countries per Directive 97/68/EC. The emissions warranty does not apply to the EU countries.

NOTE: The hp/kW rating on the engine emissions certification label specifies the gross engine hp/kW, which is flywheel power without fan. In most applications this will not be the same rating as the advertised vehicle hp/kW rating.

¹Equipment moved at least once every 12 months.

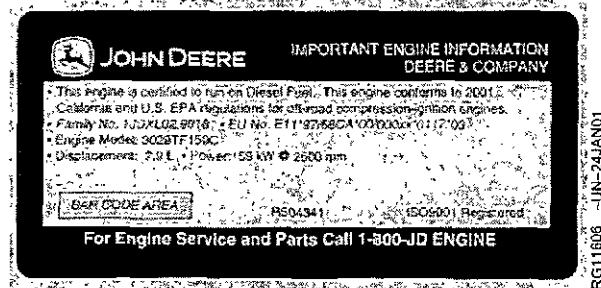

Emissions Label

U.S. Emissions Control Warranty Statement (United States Only)

Emissions control-related parts and components are warranted by John Deere for five years or 3000 hours of operation, whichever occurs first. John Deere further warrants that the engine covered by this warranty was designed, built, and equipped so as to conform at the time of sale with all U.S. emissions standards at the time of manufacture, and that it is free of defects in materials and workmanship which would cause it not to meet these standards within the period of five years or 3000 hours of operation, whichever occurs first.

Warranties stated in this manual refer only to emissions-related parts and components of your engine. The complete engine warranty, less emissions-related parts and components, is provided separately as the "John Deere New Off-Highway Engine Warranty".

RG, RG34710, 5112 -19-30JAN98-1/1

John Deere Service Literature Available

TECHNICAL INFORMATION

Technical information is available from John Deere. Some of this information is available in electronic as well as printed form. Order from your John Deere dealer or call **1-800-522-7448**. Please have available the model number, serial number, and name of the product.

Available information includes:

- **PARTS CATALOGS** list service parts available for your machine with exploded view illustrations to help you identify the correct parts. It is also useful in assembling and disassembling.
- **OPERATOR'S MANUALS** providing safety, operating, maintenance, and service information. These manuals and safety signs on your machine may also be available in other languages.
- **OPERATOR'S VIDEO TAPES** showing highlights of safety, operating, maintenance, and service information. These tapes may be available in multiple languages and formats.
- **TECHNICAL MANUALS** outlining service information for your machine. Included are specifications, illustrated assembly and disassembly procedures, hydraulic oil flow diagrams, and wiring diagrams. Some products have separate manuals for repair and diagnostic information. Some components, such as engines, are available in separate component technical manuals
- **FUNDAMENTAL MANUALS** detailing basic information regardless of manufacturer:
 - Agricultural Primer series covers technology in farming and ranching, featuring subjects like computers, the Internet, and precision farming.
 - Farm Business Management series examines "real-world" problems and offers practical solutions in the areas of marketing, financing, equipment selection, and compliance.
 - Fundamentals of Services manuals show you how to repair and maintain off-road equipment.
 - Fundamentals of Machine Operation manuals explain machine capacities and adjustments, how to improve machine performance, and how to eliminate unnecessary field operations.

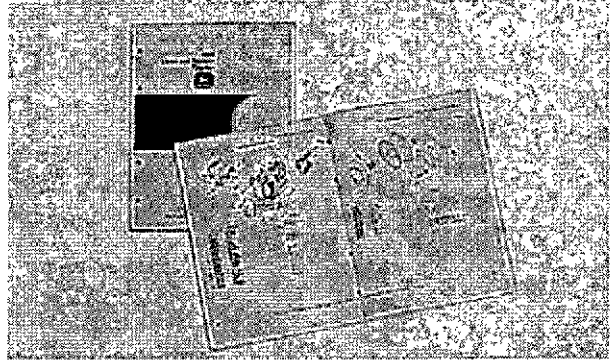

TS189 -UN-17JAN89



TS191 -UN-02DEC88

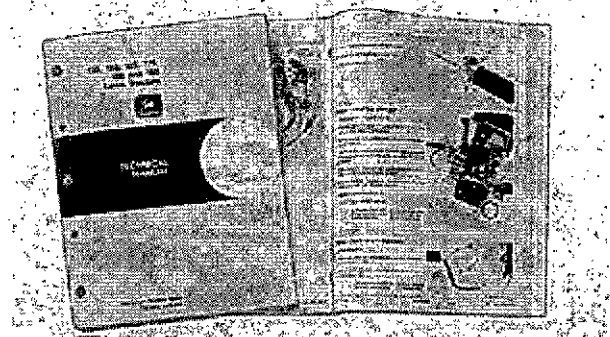

TS224 -UN-17JAN89



TS1663 -UN-10OCT97

DX,SERVLIT -19-11NOV97-1/1

PUBLICATIONS FOR THIS ENGINE

Technical information is available from John Deere in support of our products. Some of this information is available in electronic as well as printed form. Order from your John Deere dealer or call **1-800-522-7448**. Please have available the model number and serial number, and name of your John Deere engine.

Title	Order Number
POWERTeCH 2.9 L OEM Engines	
Operation and Maintenance Manual (English)	OMRG27897
Parts Catalog (Emission Certified Engines)	PC3213
Parts Catalog (Emission Non-Certified Engines)	PC3202
Component Technical Manual (All 2.9 L Engines)	
Repair, Operation and Diagnostics	CTM125
OEM Engine Accessories	CTM67
Alternators and Starter Motors	CTM77

QUOD013,0000005 -19-28NOV00-1/1

Index

	Page		Page
A			
Air cleaner		Troubleshooting	55-16
Cleaning element	50-7	Crankcase vent tube, clean	40-1
Element storage	50-8		
Inspect element	50-7	D	
Air filter, replace	50-5	Diesel engine oil	10-5
Air filter, service	50-7	Diesel fuel	10-1
Air intake system		Storage	10-2
Troubleshooting	55-18		
Air intake system, check	40-2	E	
Alternator belt	30-7	Electrical system diagram (North American)	55-2
Ammeter	15-1	Electrical system troubleshooting	55-12
Auxiliary gear drive, limitations	15-12	Emissions	
		EPA statement	75-2
B			
Batteries, Service	30-2	Warranty label	75-1
Belts, fan and alternator		Engine	
Checking tension	30-7	Add coolant	50-2
Replacing	30-7, 50-8	Break-in	15-8
Bleeding fuel system	50-3	Idling	15-17
Break-in engine oil	10-4	Operation	15-7
Break-in, engine	15-8	Starting	15-12
		Stopping	15-18
C			
Chart, service interval, prime power	20-3	Storage kit	60-1
Chart, service interval, standby power	20-5	Troubleshooting	55-1
Checking fuses	50-9	Warming	15-16
Clutch adjustment	30-9	Engine electrical system	
Cold weather aids	10-3, 15-15	Troubleshooting	55-12
Coolant		Wiring diagram (North American)	55-2
Adding	50-2	Engine oil	
Additional information	10-10	Break-In	10-4
Additives	10-12	Change	30-4
Diesel engine	10-9	Diesel	10-5
Disposing	10-13	Oil filter change	30-4
Replenishing supplemental additives	40-7	Engine speed, changing	15-17
Supplemental additives (SCAs)	10-12	Droop	45-4
Testing	10-11, 40-6	Extended diesel engine oil service intervals	10-6
Warm temperature climates	10-13		
Coolant temperature gauge	15-1	F	
Cooling system		Fan belts	30-7
Adding coolant	50-2	Filter, replace	
Check	40-5	Air	50-5
Flush and refill	45-5	Fuel	40-3
Pressure test	40-9	Oil	30-4
Pressure test radiator cap	40-9	Filters, air, service	50-7
		Fire extinguisher, service	30-1

Index

	Page		Page
Fuel		Lubricity of diesel fuel	10-1
Diesel	10-1		
Lubricity	10-1		
Fuel filter		M	
Check	25-5		
Replace	40-3	Metric torque values	65-9, 70-1
Fuel storage	10-2	Mixing lubricants	10-6
Fuel system			
Bleeding	50-3	O	
		Oil	
G		Checking and adding	25-1
Gauge panel		Fill quantity	65-5
North American	15-1	Filter, change	30-4
Grease		Refilling crankcase	30-4
Extreme pressure and multipurpose	10-8	Specifications for dipstick options	65-5
		Oil pressure gauge	15-1
H		Operating engine	
Hour meter	15-1	Break-in	15-8
		Cold weather	10-3, 15-15
		Normal operation	15-7
I		P	
Idling engine	15-17	Power take-off (PTO)	
Inch torque values	65-8	Clutch, lubricate	50-9
Instrument panel		Levers and linkages, lubricate	40-1
North American	15-1	Shaft bearings, lubricate	30-1
Intake and exhaust system		PTO clutch adjustment	30-9
Troubleshooting	55-18		
		R	
K		Radiator shutters	10-3
Kit, engine storage	60-1		
		S	
L		Service	
Lubricant		Fire extinguisher	30-1
Mixing	10-6	Intervals - prime power	20-3
Storage	10-8	Intervals - standby power	20-5
Lubrication and maintenance		Specifications	
Service interval chart - prime power	20-3	Engine crankcase oil fill	65-5
Service interval chart - standby power	20-5	Fuel injection pump-emission certified engines	65-2
Lubrication system			
Troubleshooting	55-14		

Index

	Page
Fuel injection pump-emission non-certified engines	65-3
General OEM	65-1
Torque values, metric	70-1
Standby power units	15-12
Starting engine	15-12
Stopping engine	15-18
Storage	
Air cleaner element	50-8
Fuel	10-2
Storing lubricants	10-8
Supplemental coolant additives	
Replenishing	40-7
Supplemental coolant additives (SCAs)	10-12

T

Tachometer	15-1
Temperature gauge (coolant)	15-1
Thermostat, test opening temperature	45-8
Torque values	
Inch.	65-8
Metric	65-9, 70-1
Troubleshooting	
Air intake	55-18
Cooling	55-16
Electrical	55-12
General	55-1
Lubrication	55-14
Turbocharger	55-18

W

Warming engine	15-16
Warranty	
Emission system	75-1
EPA emissions statement	75-2
Winterfronts	10-3
Wiring diagram	
North American	55-2

Index

Index-4

021201
PN=4

