

**Engine OM 904 LA, OM 906 LA
(Mod. des. 904.9, 906.9)**

Order No. 6517 5124 02

Printed in Germany

0700 0,10/0402 0,20 ff

	Contents	Part 1
--	-----------------	---------------

Title	Validity	Page
Technical data of complete engine	ENGINE 904.9, 906.9	3
Disconnecting, connecting engine wiring harness	ENGINE 906.920 /921 /922 /923 /925 /926 /927 /928 /942 /943	21
Removing, installing engine	ENGINES 904.909 /910 /911 /915 /916 /917 /922, 906.910 /911 /915 /916	26
Removing, installing engine	ENGINES 906.920 /921 /922 /923 /925 /926 /927 /928 /942 /943	34
Removing, installing engine with transmission	ENGINES 904.905 /906 /907 /921	42
Removing, installing engine with transmission	ENGINES 904.909 /910 /911 /915 /916 /917 /922, 906.910 /911 /915 /916	47
Inspecting engine for dust damage	ENGINE 541, 542, 904, 906	53
Inspecting cylinders with light probe	ENGINE 904.905 /906 /907 /908 /909 /910 /911 /915 /916 /917 /921 /922 /923, 906.910 /911 /915 /916 /919 /920 /921 /922 /923 /925 /926 /927 /928 /939 /940 /941 /942 /943 /951 /952	55
Testing compression pressure	ENGINE 904.905 /906 /907 /908 /909 /910 /911 /921 /922 /923, 906.910 /911 /920 /921 /922 /923 /940 /941 /942 /943 /951 /952	58
Removing, installing cylinder head cover	ENGINE 904.905 /906 /907 /908 /909 /910 /911 /915 /916 /917 /921 /922 /923, 906.910 /911 /915 /916 /919 /920 /921 /922 /923 /925 /926 /927 /928 /939 /940 /941 /942 /943 /951 /952	61
Removing, installing oil separator	ENGINE 904.905 /906 /907 /910 /921 ENGINE 904.908 /923 in MODEL 668, 670 ENGINE 904.909 /911 /922 ## up to 040652 ENGINE 906.910 /911 /919 /920 /921 /922 /923 ## up to 047608 ENGINE 906.940 /941 ## up to 047608 in MODEL 957	63
Removing, installing oil separator	ENGINE 904.909 /911 /922 ## as of 040653 ENGINE 906.910 /911 /920 /921 /922 /923 /940 /941 ## as of 047609 ENGINE 904.915 /916 /917, 906.915 /916 /919 /925 /926 /927 /928 /939 /942 /943	64
Removing, installing protective sleeve	ENGINE 904.905 /906 /907 /908 /909 /910 /911 /915 /916 /917 /921 /922 /923, 906.910 /911 /915 /916 /919 /920 /921 /922 /923 /925 /926 /927 /928 /939 /940 /941 /942 /943 /951 /952	65
Removing, installing cylinder head	ENGINE 904.905 /906 /907 /909 /910 /911 /915 /916 /917 /921 /922, 906.910 /911 /915 /916 /919 /920 /921 /922 /923 /925 /926 /927 /928 /939 /940 /941 /942 /943 /951 /952	69
Removing, installing decompression brake valve	ENGINE 904.905 /906 /907 /909 /910 /911 /915 /916 /917 /921 /922, 906.910 /911 /915 /916 /919 /920 /921 /922 /923 /925 /926 /927 /928 /939 /940 /941 /942 /943 /951 /952 ENGINE 904.908 /923 with CODE (MB1) Engine brake with constant throttle	76
Checking, facing cylinder head contact surface	ENGINE 904.905 /906 /907 /908 /909 /910 /911 /915 /916 /917 /921 /922 /923, 906.910 /911 /915 /916 /919 /920 /921 /922 /923 /925 /926 /927 /928 /939 /940 /941 /942 /943 /951 /952	78
Cleaning main oil gallery	ENGINE 904.905 /906 /907 /908 /909 /910 /911 /915 /916 /917 /921 /922 /923, 906.910 /911 /915 /916 /919 /920 /921 /922 /923 /925 /926 /927 /928 /939 /940 /941 /942 /943 /951 /952	83
Measuring cylinder bores	ENGINE 904.905 /906 /907 /908 /909 /910 /911 /915 /916 /917 /921 /922 /923, 906.910 /911 /915 /916 /919 /920 /921 /922 /923 /925 /926 /927 /928 /939 /940 /941 /942 /943 /951 /952	84
Flex-honing cylinder wall	ENGINE 904.905 /906 /907 /909 /910 /911 /915 /916 /917 /921 /922, 906.910 /911 /915 /916 /919 /920 /921 /922 /923 /925 /926 /927 /928 /939 /942 /943 ENGINE 904.908 /923 in MODEL 668, 670 ENGINE 906.940 /941 /951 /952 in MODEL 957	86
Widening cylinder bore in crankcase	ENGINE 904.905 /906 /907 /909 /910 /911 /915 /916 /917 /921 /922, 906.910 /911 /915 /916 /919 /920 /921 /922 /923 /925 /926 /927 /928 /939 /942 /943 ENGINE 904.908 /923 in MODEL 668, 670 ENGINE 906.940 /941 /951 /952 in MODEL 957 ENGINE 904.941 in MODEL 684	88
Removing cylinder liner	ENGINE 904.905 /906 /907 /909 /910 /911 /915 /916 /917 /921 /922, 906.910 /911 /915 /916 /919 /920 /921 /922 /923 /925 /926 /927 /928 /939 /942 /943 ENGINE 904.908 /923 in MODEL 668, 670 ENGINE 906.940 /941 /951 /952 in MODEL 957	90
Installing cylinder liner	ENGINE 904.905 /906 /907 /909 /910 /911 /915 /916 /917 /921 /922, 906.910 /911 /915 /916 /919 /920 /921 /922 /923 /925 /926 /927 /928 /939 /942 /943 ENGINE 904.908 /923 in MODEL 668, 670 ENGINE 906.940 /941 /951 /952 in MODEL 957	92



Title	Validity	Page
Removing and installing oil pan	ENGINE 904.905 /906 /907 /921	97
Removing and installing oil pan	ENGINE 904.909 /910 /911 /915 /916 /917 /922, 906.910 /911 /915 /916 /919 /920 /921 /922 /923 /925 /926 /927 /928 /939 /942 /943	99
Removing, installing timing case	ENGINE 904.905 /906 /907 /909 /910 /911 /915 /916 /917 /921 /922, 906.910 /911 /915 /916 /920 /921 /922 /923 /925 /926 /927 /928 /939 /942 /943 ENGINE 904.908 /923 in MODEL 668, 670 ENGINE 906.940 /941 /951 /952 in MODEL 957	101
Removing, installing timing case	ENGINE 906.920 /921 /922 /923 /925 /926 /927 /928 timing case SAE 1 or 2, readied for engine output or installed engine output	103

	Contents	Part 2
--	-----------------	---------------

Title	Validity	Page
Removing and installing pistons	ENGINE 904.905 /906 /907 /909 /910 /911 /915 /916 /917 /921 /922, 906.910 /911 /915 /916 /919 /920 /921 /922 /923 /925 /926 /927 /928 /939 /942 /943 ENGINE 904.908 /923 in MODEL 668, 670 ENGINE 906.940 /941 /951 /952 in MODEL 957	3
Removing and installing piston rings	ENGINE 904.905 /906 /907 /909 /910 /911 /915 /916 /917 /921 /922, 906.910 /911 /915 /916 /919 /920 /921 /922 /923 /925 /926 /927 /928 /939 /942 /943 ENGINE 904.908 /923 in MODEL 668, 670 ENGINE 906.940 /941 /951 /952 in MODEL 957	13
Testing, repairing connecting rod	ENGINE 904.905 /906 /907 /908 /909 /910 /911 /915 /916 /917 /921 /922 /923, 906.910 /911 /915 /916 /919 /920 /921 /922 /923 /925 /926 /927 /928 /939 /940 /941 /942 /943 /951 /952	15
Replacing front crankshaft radial seal	ENGINE 904.905 /906 /907 /909 /910 /911 /915 /916 /917 /921 /922, 906.910 /911 /915 /916 /919 /920 /921 /922 /923 /925 /926 /927 /928 /939 /942 /943 ENGINE 904.908 /923 in MODEL 668, 670 ENGINE 906.940 /941 /951 /952 in MODEL 957	25
Replacing rear crankshaft radial seal	ENGINE 904.905 /906 /907 /909 /910 /911 /915 /916 /917 /921 /922, 906.910 /911 /915 /916 /919 /920 /921 /922 /923 /925 /926 /927 /928 /939 /942 /943 ENGINE 904.908 /923 in MODEL 668, 670 ENGINE 906.940 /941 /951 /952 in MODEL 957	27
Removing and installing crankshaft	ENGINE 904.905 /906 /907 /908 /909 /910 /911 /915 /916 /917 /921 /922 /923, 906.910 /911 /915 /916 /919 /920 /921 /922 /923 /925 /926 /927 /928 /939 /940 /941 /942 /943 /951 /952	29
Measuring and mounting crankshaft	ENGINE 904.905 /906 /907 /908 /909 /910 /911 /915 /916 /917 /921 /922 /923, 906.910 /911 /915 /916 /919 /920 /921 /922 /923 /925 /926 /927 /928 /939 /940 /941 /942 /943 /951 /952	36
Removing and installing crankshaft gear	ENGINE 904.905 /906 /907 /909 /910 /911 /915 /916 /917 /921 /922, 906.910 /911 /915 /916 /919 /920 /921 /922 /923 /925 /926 /927 /928 /939 /942 /943 ENGINE 904.908 /923 in MODEL 668, 670 ENGINE 906.940 /941 /951 /952 in MODEL 957	44
Removing, installing drive gear for oil pump on crankshaft	ENGINE 904.905 /906 /907 /909 /910 /911 /915 /916 /917 /921 /922, 906.910 /911 /915 /916 /919 /920 /921 /922 /923 /925 /926 /927 /928 /939 /942 /943 ENGINE 904.908 /923 in MODEL 668, 670 ENGINE 906.940 /941 /951 /952 in MODEL 957	45
Removing and installing belt pulley/vibration damper	ENGINE 904.905 /906 /907 /909 /910 /911 /915 /916 /917 /921 /922, 906.910 /911 /915 /916 /919 /920 /921 /922 /923 /925 /926 /927 /928 /939 /940 /941 /942 /943 /951 /952	46
Removing, installing flywheel	ENGINE 904.905 /906 /907 /909 /910 /911 /915 /916 /917 /921 /922, 906.910 /911 /915 /916 /919 /920 /921 /922 /923 /925 /926 /927 /928 /939 /942 /943 ENGINE 904.908 /923 in MODEL 668, 670 ENGINE 906.940 /941 /951 /952 in MODEL 957	49
Checking and re-machining flywheel	ENGINE 904.905 /906 /907 /909 /910 /911 /915 /916 /917 /921 /922, 906.910 /911 /915 /916 /919 /920 /921 /922 /923 /925 /926 /927 /928 /939 /942 /943 ENGINE 904.908 /923 in MODEL 668, 670	52
Replacing ring gear of flywheel	ENGINE 904.905 /906 /907 /909 /910 /911 /915 /916 /917 /921 /922, 906.910 /911 /915 /916 /919 /920 /921 /922 /923 /925 /926 /927 /928 /939 /942 /943 ENGINE 904.908 /923 in MODEL 668, 670	55
Removing, installing guide bearing in flywheel	ENGINE 904.905 /906 /907 /909 /910 /911 /921 /922 ## up to 106313 ENGINE 906.910 /911 /920 /921 /922 /923 ## up to 106161 ENGINE 904.908 /923 in MODEL 668, 670	57
Removing, installing guide bearing in flywheel	ENGINE 904.905 /906 /907 /909 /910 /911 /921 /922 /926 /932 ## as of 106314 ENGINE 906.910 /911 /920 /921 /922 /923 /929 /932 /933 ## as of 106162 ENGINE 904.915 /916 /917, 906.915 /916 /925 /926 /927 /928 /939 /942 /943	60
Checking valve lift	ENGINE 904.905 /906 /907 /909 /910 /911 /915 /916 /917 /921 /922, 906.910 /911 /915 /916 /919 /920 /921 /922 /923 /925 /926 /927 /928 /939 /942 /943 ENGINE 904.908 /923 in MODEL 668, 670 ENGINE 906.940 /941 /951 /952 in MODEL 957	62
Removing, installing rocker arm assembly	ENGINE 904.905 /906 /907 /908 /921 ## up to 39739	64

Title	Validity	Page
Removing, installing rocker arm assembly	ENGINE 904.905 /906 /907 /908 /921 ## as of 039740 ENGINE 904.909 /910 /911 /915 /916 /917 /922 /923, 906.910 /911 /915 /916 /919 /920 /921 /922 /923 /925 /926 /927 /928 /939 /940 /941 /942 /943 /951 /952	67
Disassembling, assembling rocker arm assembly	ENGINE 904.905 /906 /907 /908 /909 /910 /911 /915 /916 /917 /921 /922 /923, 906.910 /911 /915 /916 /919 /920 /921 /922 /923 /925 /926 /927 /928 /939 /940 /941 /942 /943 /951 /952	69
Removing and installing valves	ENGINE 904.905 /906 /907 /909 /910 /911 /915 /916 /917 /921 /922, 906.910 /911 /915 /916 /919 /920 /921 /922 /923 /925 /926 /927 /928 /939 /942 /943 ENGINE 904.908 /923 in MODEL 668, 670 ENGINE 906.940 /941 /951 /952 in MODEL 957	71
Replace valve guide	ENGINE 904.905 /906 /907 /909 /910 /911 /915 /916 /917 /921 /922, 906.910 /911 /915 /916 /919 /920 /921 /922 /923 /925 /926 /927 /928 /939 /942 /943 ENGINE 904.908 /923 in MODEL 668, 670 ENGINE 906.940 /941 /951 /952 in MODEL 957	82
Replacing valve stem seals	ENGINE 904.905 /906 /907 /908 /909 /910 /911 /915 /916 /917 /921 /922 /923, 906.910 /911 /915 /916 /919 /920 /921 /922 /923 /925 /926 /927 /928 /939 /940 /941 /942 /943 /951 /952	87
Replacing valve seat rings	ENGINE 904.905 /906 /907 /909 /910 /911 /915 /916 /917 /921 /922, 906.910 /911 /915 /916 /919 /920 /921 /922 /923 /925 /926 /927 /928 /939 /942 /943 ENGINE 904.908 /923 in MODEL 668, 670 ENGINE 906.940 /941 /951 /952 in MODEL 957	89

Title	Validity	Page
Machining valve seat rings	ENGINE 904.905 /906 /907 /909 /910 /911 /915 /916 /917 /921 /922, 906.910 /911 /915 /916 /919 /920 /921 /922 /923 /925 /926 /927 /928 /939 /942 /943 ENGINE 904.908 /923 in MODEL 668, 670 ENGINE 906.940 /941 /951 /952 in MODEL 957	3
Grinding valves	ENGINE 904.905 /906 /907 /909 /910 /911 /915 /916 /917 /921 /922, 906.910 /911 /915 /916 /919 /920 /921 /922 /923 /925 /926 /927 /928 /939 /942 /943 ENGINE 904.908 /923 in MODEL 668, 670 ENGINE 906.940 /941 /951 /952 in MODEL 957	16
Removing and installing camshaft	ENGINE 904.905 /906 /907 /909 /910 /911 /915 /916 /917 /921 /922, 906.910 /911 /915 /916 /919 /920 /921 /922 /923 /925 /926 /927 /928 /939 /942 /943 ENGINE 904.908 /923 in MODEL 668, 670 ENGINE 906.940 /941 /951 /952 in MODEL 957	19
Removing, installing MR/PLD control unit	ENGINE 904.905 /906 /907 /909 /910 /911 /915 /916 /917 /921 /922, 906.910 /911 /915 /916 /919 /920 /921 /922 /923 /925 /926 /927 /928 /939 /942 /943	24
Removing, installing MR/PLD injection lines	ENGINE 904.905 /906 /907 /909 /910 /911 /915 /916 /917 /921 /922, 906.910 /911 /915 /916 /919 /920 /921 /922 /923 /925 /926 /927 /928 /939 /942 /943 ENGINE 904.908 /923 in MODEL 668, 670 ENGINE 906.940 /941 /951 /952 in MODEL 957	27
Removing and installing nozzle holder combination	ENGINE 904.905 /906 /907 /921 ## up to 40487 ENGINE 904.908 ## up to 40487 in MODEL 668, 670	31
Removing and installing nozzle holder combination	ENGINE 904.905 /906 /907 /921 ## as of 040488 ENGINE 904.908 ## as of 040488 in MODEL 668, 670 ENGINE 904.923 in MODEL 668, 670 ENGINE 904.909 /910 /911 /915 /916 /917 /922, 906.910 /911 /915 /916 /920 /921 /922 /923 /925 /926 /927 /928 /939 /940 /941 /942 /943 /951 /952	34
Removing, installing MR/PLD unit pump	ENGINE 904.905 /906 /907 /908 /909 /910 /911 /915 /916 /917 /921 /922 /923, 906.910 /911 /915 /916 /919 /920 /921 /922 /923 /925 /926 /927 /928 /939 /940 /941 /942 /943 /951 /952	37
Removing, adjusting and installing crankshaft angle position sensor bracket	ENGINE 904.905 /906 /907 /908 /909 /910 /911 /921 /922 /923 ## up to 082245 ENGINE 906.910 /911 /919 /920 /921 /922 /923 /940 /941 ## up to 082652	40
Testing low pressure fuel circuit	ENGINE 904.905 /906 /907 /921 ## up to 040487	43
Testing low pressure fuel circuit	ENGINE 904.905 /906 /907 /921 ## as of 040488 ENGINE 904.909 /910 /911 /915 /916 /917 /922, 906.910 /911 /915 /916 /919 /920 /921 /922 /923 /925 /926 /927 /928 /939 /940 /941 /942 /943 /951 /952	60
Inspecting turbocharger	ENGINE 904.905 /906 /907 /909 /910 /911 /915 /916 /917 /921 /922, 906.910 /911 /915 /916 /919 /920 /921 /922 /923 /925 /926 /927 /928 /939 /940 /941 /942 /943 /951 /952	68
Removing and installing exhaust gas turbocharger	ENGINE 904.905 /906 /907 /909 /910 /911 /915 /916 /917 /921 /922, 906.910 /911 /915 /916 /919 /920 /921 /922 /923 /925 /926 /927 /928 /939 /940 /941 /942 /943 /951 /952	71
Removing, installing boost air pipe	ENGINE 904.905 /906 /907 /921	76
Removing and installing charge air pipe	ENGINE 904.909 /910 /911 /915 /916 /917 /922, 906.910 /911 /915 /916 /919 /920 /921 /922 /923 /925 /926 /927 /928 /939 /940 /941 /942 /943 /951 /952 From turbocharger to charge air cooler	77
Removing and installing charge air pipe	ENGINE 904.909 /910 /911 /915 /916 /917 /922, 906.910 /911 /915 /916 /919 /920 /921 /922 /923 /925 /926 /927 /928 /939 /942 /943 From charge air cooler to charge air manifold	79
Removing and installing boost air manifold	ENGINE 904.905 /906 /907 /921	81
Removing, installing boost air manifold	ENGINE 904.909 /910 /911 /915 /916 /917 /922, 906.910 /911 /915 /916 /919 /920 /921 /922 /923 /925 /926 /927 /928 /939 /940 /941 /942 /943 /951 /952	83
Removing, installing boost pressure, boost air temperature sensor	ENGINE 904.905 /906 /907 /921 /908 ## as of 040488, 904.909 /910 /911 /915 /916 /917 /922 /923, 906.910 /911 /915 /916 /919 /920 /921 /922 /923 /925 /926 /927 /928 /939 /942 /943	84
Testing charge air cooler and charge air hoses for leaks	ENGINE 904.909 /910 /911 /915 /916 /917 /922, 906.910 /911 /915 /916 /919 /920 /921 /922 /923 /925 /926 /927 /928 /939 /942 /943	85

Title	Validity	Page
Removing and installing poly-V-belt	ENGINE 904.905 /906 /907 /909 /910 /911 /915 /916 /917 /921 /922, 906.910 /911 /915 /916 /919 /920 /921 /922 /923 /925 /926 /927 /928 /939 /942 /943	87
Removing and installing poly-V-belt tensioning device	ENGINE 904.905 /906 /907 /909 /910 /911 /915 /916 /917 /921 /922, 906.910 /911 /915 /916 /919 /920 /921 /922 /923 /925 /926 /927 /928 /939 /942 /943 ENGINE 904.908 /923 in MODEL 668, 670	89
Removing, installing compressor	ENGINES 904.905 /906 /907 /908 /909 /910 /911 /915 /916 /917 /921 /922 /923, 906.910 /911 /915 /916 /919 /920 /921 /922 /923 /925 /926 /927 /928 /939 /942 /943 with single-cylinder compressor	90

Title	Validity	Page
Removing and installing exhaust manifold	ENGINE 904.905 /906 /907 /909 /910 /911 /915 /916 /917 /921 /922, 906.910 /911 /915 /916 /919 /920 /921 /922 /923 /925 /926 /927 /928 /939 /940 /941 /942 /943 /951 /952	3
Removing, installing engine brake flap connection	ENGINE 904.905 /906 /907 /909 /910 /911 /915 /916 /917 /921 /922	10
Removing, installing engine brake flap connection	ENGINE 906.910 /911 /915 /916 /919 /920 /921 /922 /923 /925 /926 /927 /928 /939 /940 /941 /942 /943 /951 /952	12
Repairing engine brake flap connection	ENGINE 904.905 /906 /907 /908 /909 /910 /911 /915 /916 /917 /921 /922 /923	14
Repairing engine brake flap connection	ENGINE 906.910 /911 /915 /916 /919 /920 /921 /922 /923 /925 /926 /927 /928 /939 /940 /941 /942 /943	17
Removing and installing starter	ENGINE 904.905 /906 /907 /909 /910 /911 /915 /916 /917 /921 /922, 906.910 /911 /915 /916 /919 /920 /921 /922 /923 /925 /926 /927 /928 /939 /940 /941 /942 /943 /951 /952	20
Removing and installing generator	ENGINE 904.905 /906 /907 /909 /910 /911 /915 /916 /917 /921 /922, 906.910 /911 /915 /916 /919 /920 /921 /922 /923 /925 /926 /927 /928 /939 /942 /943	22
Removing and installing the generator poly-V-pulley	ENGINE 904.905 /906 /907 /909 /910 /911 /915 /916 /917 /921 /922, 906.910 /911 /915 /916 /919 /920 /921 /922 /923 /925 /926 /927 /928 /939 /942 /943	24
Removing and installing oil pump	ENGINE 904.905 /906 /907 /909 /910 /911 /915 /916 /917 /921 /922, 906.910 /911 /915 /916 /919 /920 /921 /922 /923 /925 /926 /927 /928 /939 /942 /943 /951 /952 ENGINE 904.908 /923 in MODEL 668, 670 ENGINE 906.940 /941 in MODEL 957	26
Removing and installing the oil/water heat exchanger	ENGINE 904.905 /906 /907 /909 /910 /911 /915 /916 /917 /921 /922, 906.910 /911 /915 /916 /919 /920 /921 /922 /923 /925 /926 /927 /928 /939 /940 /941 /942 /943 /951 /952	29
Removing and installing oil filter housing	ENGINE 904.905 /906 /907 /909 /910 /911 /915 /916 /917 /921 /922, 906.910 /911 /915 /916 /919 /920 /921 /922 /923 /925 /926 /927 /928 /939 /940 /941 /942 /943 /951 /952	34
Removing, installing oil filter bypass valve	ENGINE 904.905 /906 /907 /921 ## up to 16109 ENGINE 904.908 ## up to 16109 in MODEL 668, 670	37
Removing, installing oil pressure, oil temperature sensor	ENGINE 904.905 /906 /907 /908 /921 ## as of 040488 ENGINE 904.915 /916 /917 /909 /910 /911 /922 /923, 906.910 /911 /915 /916 /919 /920 /921 /922 /923 /925 /926 /927 /928 /939 /940 /941 /942 /943 /951 /952	40
Removing and installing oil level sensor	ENGINE 904.909 /910 /911 /915 /916 /917 /922, 906.910 /911 /915 /916 /919 /920 /921 /922 /923 /925 /926 /927 /928 /939 /940 /941 /951 /952 /942 /943	42
Removing and installing oil spray nozzles (pistons)	ENGINE 904.908 /923 in MODEL 668, 670 ENGINE 904.905 /906 /907 /909 /910 /911 /921 /922 ## up to 066192 ENGINE 906.910 /911 /920 /921 /922 /923 ## up to 067198 ENGINE 906.940 /941 ## up to 067198 in MODEL 957	44
Removing and installing oil spray nozzles (pistons)	ENGINE 904.909 /910 /911 /922 ## as of 066193 ENGINE 906.910 /911 /920 /921 /922 /923 /940 /941 ## as of 067199 ENGINE 904.915 /916 /917, 906.915 /916 /925 /926 /927 /928 /939 /942 /943 /951 /952	46
Filling engine oil circuit	ENGINE 904.905 /906 /907 /909 /910 /911 /915 /916 /917 /921 /922, 906.910 /911 /915 /916 /919 /920 /921 /922 /923 /925 /926 /927 /928 /939 /942 /943 ENGINE 904.908 /923 in MODEL 668, 670 ENGINE 906.940 /941 /951 /952 in MODEL 957	48
Removing and installing engine coolant pump	ENGINE 904.905 /906 /907 /909 /910 /911 /915 /916 /917 /921 /922, 906.910 /911 /915 /916 /919 /920 /921 /922 /923 /925 /926 /927 /928 /939 /940 /941 /942 /943 /951 /952	50
Disassembling, assembling coolant pump	ENGINE 904.905 /906 /907 /909 /910 /911 /915 /916 /917 /921 /922, 906.910 /911 /915 /916 /919 /920 /921 /922 /923 /925 /926 /927 /928 /939 /942 /943 ENGINE 904.908 /923 in MODEL 668, 670 ENGINE 906.940 /941 /951 /952 in MODEL 957	52
Removing and installing engine coolant thermostat	ENGINE 904.905 /906 /907 /909 /910 /911 /915 /916 /917 /921 /922, 906.910 /911 /915 /916 /919 /920 /921 /922 /923 /925 /926 /927 /928 /939 /942 /943 ENGINE 904.908 /923 in MODEL 668, 670 ENGINE 906.940 /941 /951 /952 in MODEL 957	55
Testing coolant thermostat	ENGINE 904.9, 906.9 ENGINE 541.9, 542.9	57

Title	Validity	Page
Removing and installing fan shroud	ENGINE 904.909 /910 /911 /915 /916 /917 /922, 906.910 /911 /915 /916 /939 /942 /943	59
Removing and installing fan	ENGINE 904.909 /910 /911 /915 /916 /917 /922, 906.910 /911 /915 /916 /919 /920 /921 /922 /923 /925 /926 /927 /928 /939 /942 /943	61
Removing, installing radiator	ENGINE 904.905 /906 /907 /921	63
Removing and installing radiator	ENGINE 904.909 /910 /911 /915 /916 /917 /922	65
Removing and installing radiator	ENGINE 906.920 /921 /922 /923 /925 /926 /927 /928 /942 /943	67
Removing and installing expansion tank	ENGINE 904.909 /910 /911 /915 /916 /917 /922, 906.910 /911 /915 /916 with BODY 972.899	70
Removing grease and scale in cooling system	ENGINE 904.905 /906 /907 /909 /910 /911 /915 /916 /917 /921 /922, 906.910 /911 /915 /916 /919 /920 /921 /922 /923 /925 /926 /927 /928 /939 /942 /943 ENGINE 904.908 /923 in MODEL 668, 670 ENGINE 906.940 /941 /951 /952 in MODEL 957	72
Checking cooling system for leaks	ENGINES 904.909 /910 /911 /915 /916 /917 /922, 906.910 /911 /915 /916 /940 /941 /942 /943 /951 /952	75
Removing and installing coolant level sensor	ENGINE 904.909 /910 /911 /915 /916 /917 /922, 906.910 /911 /915 /916 /939 /942 /943	77
Removing and installing power steering pump	STEERING 765.602 /604 /605 /820 /821 /830 /840 /844 /861 /865 /889 with ENGINE 904.905 /906 /907 /909 /910 /911 /915 /916 /917 /921 /922, 906.910 /911 /915 /916 /919 /920 /921 /922 /923 /925 /926 /927 /928 /939 /940 /941 /942 /943 /951 /952	78
Removing, installing fuel full-flow filter	ENGINE 904.905 /906 /907 /921 ## up to 33991 ENGINE 904.908 ## up to 33991 in MODEL 668, 670	80
Removing and installing fuel full-flow filter	ENGINE 904.905 /906 /907 /908 /921 ## as of 033992 ENGINE 904.909 /910 /911 /915 /916 /917 /922 /923, 906.910 /911 /915 /916 /919 /920 /921 /922 /923 /925 /926 /927 /928 /939 /940 /941 /942 /943 /951 /952	82
Removing, installing fuel heat exchanger	ENGINE 904.905 /906 /907 /921 ## up to 33991 ENGINE 904.908 ## up to 33991 in MODEL 668, 670	84
Removing and installing fuel pumps	ENGINE 904.905 /906 /907 /909 /910 /911 /915 /916 /917 /921 /922, 906.910 /911 /915 /916 /919 /920 /921 /922 /923 /925 /926 /927 /928 /939 /942 /943 ENGINE 904.908 /923 in MODEL 668, 670 ENGINE 906.940 /941 /951 /952 in MODEL 957	86

Part 1

ENGINE 904.9, 906.9

Technical data engine	OM 904LA (engine 904.905)	Page 3
	OM 904LA (engine 904.906/908)	Page 4
	OM 904LA (engine 904.907)	Page 5
	OM 904LA (engine 904.909)	Page 6
	OM 904LA (engine 904.915)	Page 7
	OM 904LA (engine 904.911)	Page 8
	OM 904LA (engine 904.921/922/923)	Page 9
	OM 904LA (engine 904.916)	Page 10
	OM 906LA (engine 906.910/920/922)	Page 11
	OM 906LA (engine 906.940)	Page 12
	OM 906LA (engine 906.915/925/927/951)	Page 13
	OM 906LA (engine 906.911/921/923)	Page 14
	OM 906LA (engine 906.941)	Page 15
	OM 906LA (engine 906.916/926/928/952)	Page 17
	OM 906LA (engine 906.939)	Page 18
OM 906LA (engine 906.920/922)	Page 19	

- P* Engine output
- M* Engine torque
- n* Rated speed
- b* Specific fuel consumption

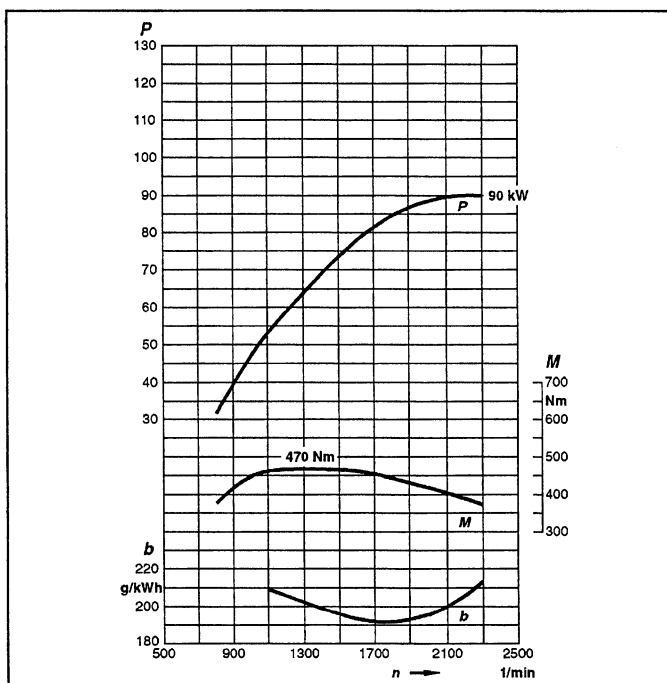

W01.00-0002-12

Engine model designation		904.905
Engine type		OM 904LA I/1
Engine power (P)	kW/HP	90 (122)
	rpm	2300
Engine torque (M) max.	Nm	470
	rpm	1200 – 1500
Rated speed	rpm	2300
Bore	mm	102
Stroke	mm	130
Total displacement	cm ³	4250
Compression ratio	ϵ	17,4
Firing order		1-3-4-2
Number and arrangement of cylinders		4 inline
Valves	Inlet	2
	Exhaust	1
Working method	4-stroke diesel with direct injection	
Combustion method	Exhaust turbocharger and intercooler	
Injection method	Single unit pump with pump-line-nozzle system (PLD)	
Timing	Electronic engine management with solenoid valve-controlled fuel injection	
Specific fuel consumption (b)	g/kWh (see diagram)	

GF01.00-W-1000-01B	Technical data engine	Engine 904.906/908	
--------------------	-----------------------	--------------------	--

- P* Engine output
- M* Engine torque
- n* Rated speed
- b* Specific fuel consumption

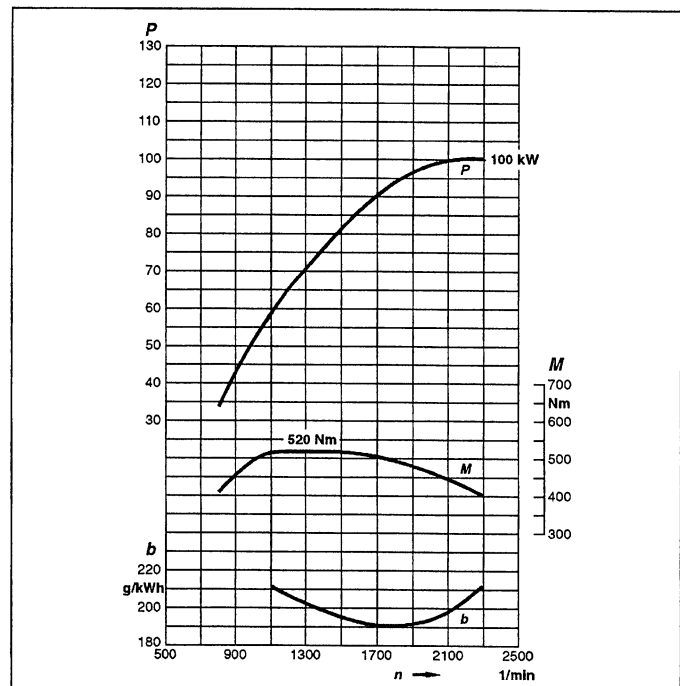

W01.00-0003-12

Engine model designation		904.906/908
Engine type		OM 904LA II/1
Engine power (P)	kW/HP	100 (136)
	rpm	2300
Engine torque (M) max.	Nm	520
	rpm	1200 – 1500
Rated speed	rpm	2300
Bore	mm	102
Stroke	mm	130
Total displacement	cm ³	4250
Compression ratio	ϵ	17,4
Firing order		1-3-4-2
Number and arrangement of cylinders		4 inline
Valves	Inlet	2
	Exhaust	1
Working method	4-stroke diesel with direct injection	
Combustion method	Exhaust turbocharger and intercooler	
Injection method	Single unit pump with pump-line-nozzle system (PLD)	
Timing	Electronic engine management with solenoid valve-controlled fuel injection	
Specific fuel consumption (b)	g/kWh (see diagram)	

GF01.00-W-1000-01C	Technical data engine	Engine 904.907	
--------------------	-----------------------	----------------	---

- P* Engine output
- M* Engine torque
- n* Rated speed
- b* Specific fuel consumption

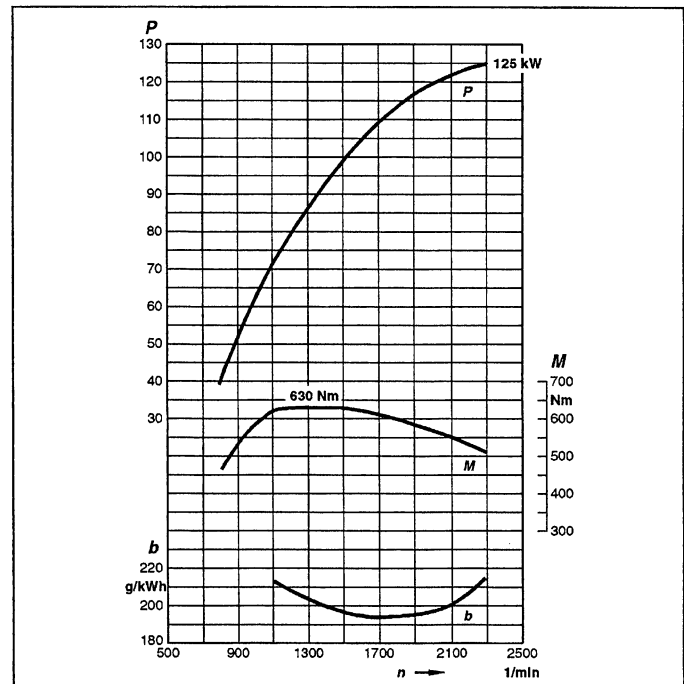

W01.00-0004-12

Engine model designation		904.907
Engine type		OM 904LA III/3
Engine power (P)	kW/HP	125 (170)
	rpm	2300
Engine torque (M) max.	Nm	630
	rpm	1200 – 1500
Rated speed	rpm	2300
Bore	mm	102
Stroke	mm	130
Total displacement	cm ³	4250
Compression ratio	ϵ	17,4
Firing order		1-3-4-2
Number and arrangement of cylinders		4 inline
Valves	Inlet	2
	Exhaust	1
Working method	4-stroke diesel with direct injection	
Combustion method	Exhaust turbocharger and intercooler	
Injection method	Single unit pump with pump-line-nozzle system (PLD)	
Timing	Electronic engine management with solenoid valve-controlled fuel injection	
Specific fuel consumption (b)	g/kWh (see diagram)	

GF01.00-W-1000-01K	Technical data - engine	Engine 904.909	
--------------------	-------------------------	----------------	--

- P* Engine output
- M* Engine torque
- n* Rated speed
- b* Specific fuel consumption

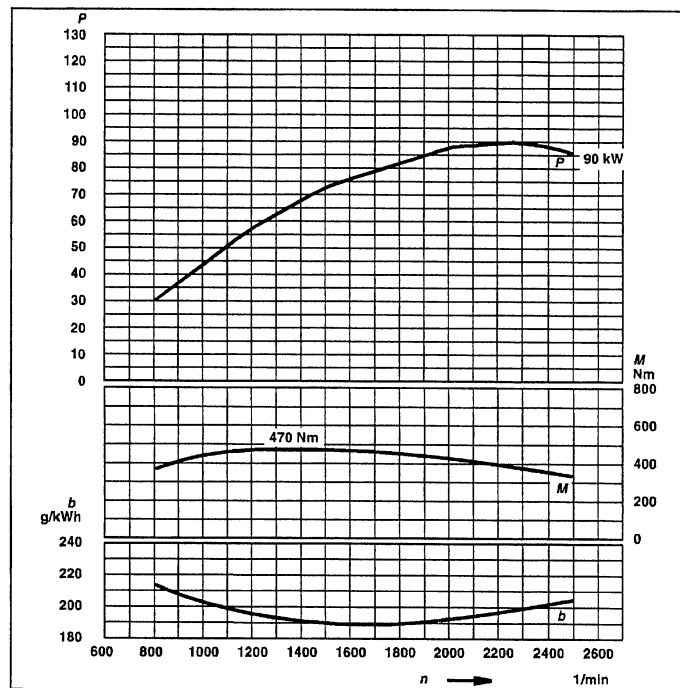

W01.00-0023-12

Engine model designation		904.909
Engine type		OM 904 LA II/2
Engine output (P)	kW/hp	90/122
	min ⁻¹	2300
Engine torque (M) max.	Nm	470
	min ⁻¹	1200-1500
Rated speed/upper load speed	min ⁻¹	2300/2500
Bore	mm	102
Stroke	mm	130
Total displacement	cm ³	4250
Compression ratio	ϵ	17.4
Firing order		1-3-4-2
Number/arrangement of cylinders		4 inline
Valves	inlet	2
	Exhaust	1
Working method	4-stroke diesel with direct injection	
Combustion method	Exhaust gas turbocharging and charge air cooling	
Injection method	Single unit pump with pump-line-nozzle system (PLD)	
Timing	Electronic engine management with solenoid valve-controlled fuel injection	
Spec. fuel consumption (b)	g/kWh (see chart)	

GF01.00-W-1000-01KA	Technical data - engine	Engine 904.915	
---------------------	-------------------------	----------------	---

- P* Engine output
- M* Engine torque
- n* Rated speed
- b* Specific fuel consumption

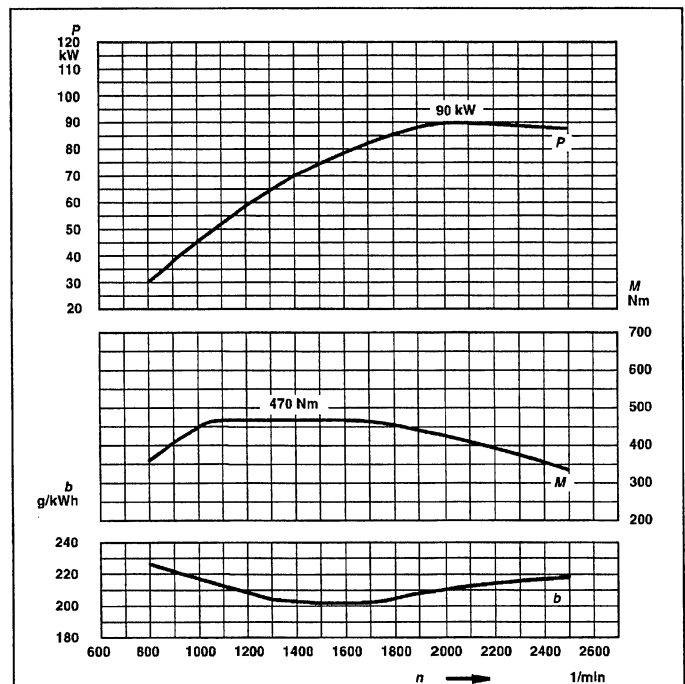

W01.00-1015-12

Engine model designation		904.915
Engine type		OM 904 LA III/1
Engine output (P)	kW/hp	90/122
	rpm	2200
Engine torque (M) max.	Nm	470
	rpm	1200-1600
Rated speed/upper load speed	rpm	2200/2500
Bore	mm	102
Stroke	mm	130
Total displacement	cm ³	4250
Compression ratio	ϵ	18.0
Firing order		1-3-4-2
Number/arrangement of cylinders		4 inline
Valves	inlet	2
	Exhaust	1
Working method	4-stroke diesel with direct injection	
Combustion method	Exhaust turbocharging and charge air cooling	
Injection method	Single unit pump with pump-line-nozzle system (PLD)	
Engine management	Electronic engine management with solenoid valve-controlled fuel injection	
Specific fuel consumption (b)	g/kWh (see chart)	

GF01.00-W-1000-01L	Technical data - engine	Engine 904.911	
--------------------	-------------------------	----------------	--

- P* Engine output
- M* Engine torque
- n* Rated speed
- b* Specific fuel consumption

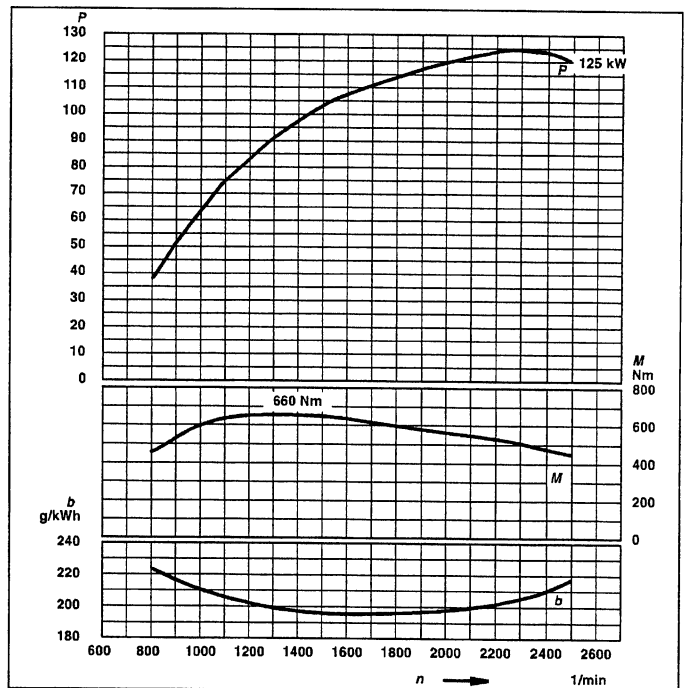

W01.00-0025-12

Engine model designation		904.911
Engine type		OM 904 LA II/4
Engine output (P)	kW/hp	125/170
	min ⁻¹	2300
Engine torque (M) max.	Nm	660
	min ⁻¹	1200-1500
Rated speed/upper load speed	min ⁻¹	2300/2500
Bore	mm	102
Stroke	mm	130
Total displacement	cm ³	4250
Compression ratio	ϵ	17.4
Firing order		1-3-4-2
Number/arrangement of cylinders		4 inline
Valves	inlet	2
	Exhaust	1
Working method	4-stroke diesel with direct injection	
Combustion method	Exhaust gas turbocharging and charge air cooling	
Injection method	Single unit pump with pump-line-nozzle system (PLD)	
Timing	Electronic engine management with solenoid valve-controlled fuel injection	
Spec. fuel consumption (b)	g/kWh (see chart)	

GF01.00-W-1000-01M	Technical data - engine	Engine 904.921/922/923	
--------------------	-------------------------	------------------------	---

- P* Engine output
- M* Engine torque
- n* Rated speed
- b* Specific fuel consumption

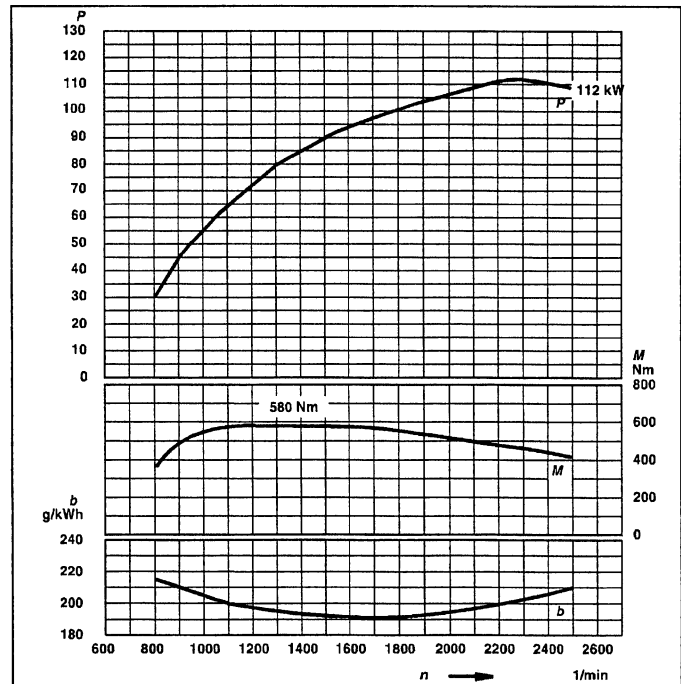

W01.00-0020-12

Engine model designation		904.921/922/923
Engine type		OM 904 LA II/8
Engine output (P)	kW/hp	112/152
	min ⁻¹	2300
Engine torque (M) max.	Nm	580
	min ⁻¹	1200-1500
Rated speed/upper load speed	min ⁻¹	2300/2500
Bore	mm	102
Stroke	mm	130
Total displacement	cm ³	4250
Compression ratio	ϵ	17.4
Firing order		1-3-4-2
Number/arrangement of cylinders		4 inline
Valves	inlet	2
	Exhaust	1
Working method	4-stroke diesel with direct injection	
Combustion method	Exhaust gas turbocharging and charge air cooling	
Injection method	Single unit pump with pump-line-nozzle system (PLD)	
Timing	Electronic engine management with solenoid valve-controlled fuel injection	
Spec. fuel consumption (b)	g/kWh (see chart)	

GF01.00-W-1000-01MA	Technical data - engine	Engine 904.916	
---------------------	-------------------------	----------------	--

- P* Engine output
M Engine torque
n Rated speed
b Specific fuel consumption

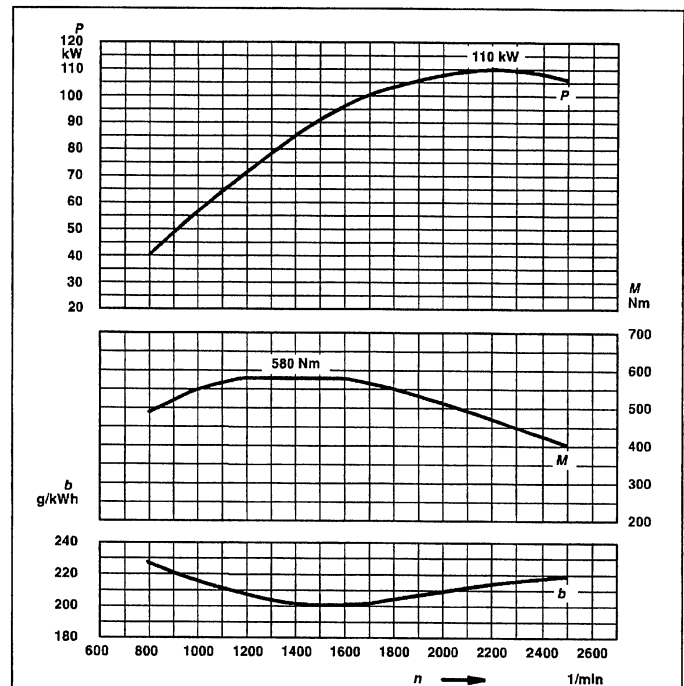

W01.00-1016-12

Engine model designation		904.916
Engine type		OM 904 LA III/2
Engine output (P)	kW/hp	110/150
	rpm	2200
Engine torque (M) max.	Nm	580
	rpm	1200-1600
Rated speed/upper load speed	rpm	2200/2500
Bore	mm	102
Stroke	mm	130
Total displacement	cm ³	4250
Compression ratio	ϵ	18.0
Firing order		1-3-4-2
Number/arrangement of cylinders		4 inline
Valves	inlet	2
	Exhaust	1
Working method	4-stroke diesel with direct injection	
Combustion method	Exhaust turbocharging and charge air cooling	
Injection method	Single unit pump with pump-line-nozzle system (PLD)	
Engine management	Electronic engine management with solenoid valve-controlled fuel injection	
Specific fuel consumption (b)	g/kWh (see chart)	

GF01.00-W-1000-01N	Technical data - engine	Engine 906.910/920/922	
--------------------	-------------------------	------------------------	---

- P* Engine output
- M* Engine torque
- n* Rated speed
- b* Specific fuel consumption

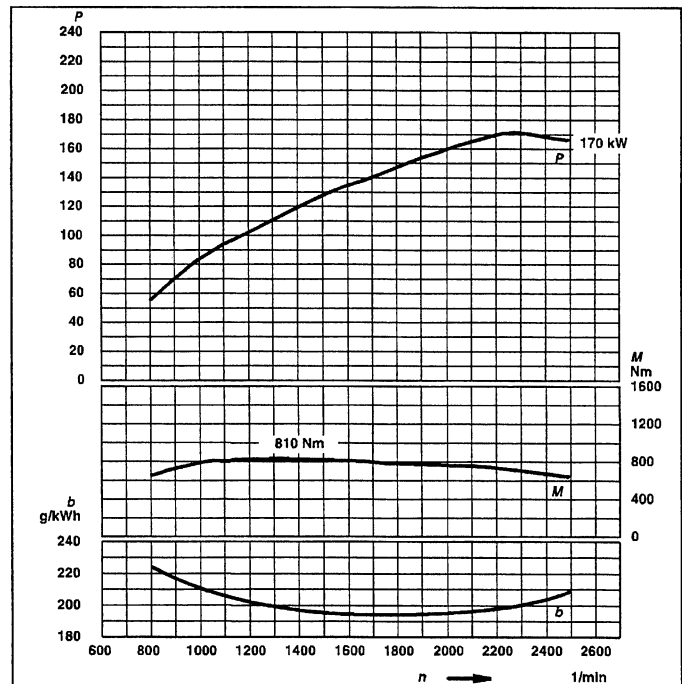

W01.00-0026-12

Engine model designation		906.910/920/922
Engine type		OM 906 LA II/1
Engine output (P)	kW/hp	170/231
	min ⁻¹	2300
Engine torque (M) max.	Nm	810
	min ⁻¹	1200-1500
Rated speed/upper load speed	min ⁻¹	2300/2500
Bore	mm	102
Stroke	mm	130
Total displacement	cm ³	6370
Compression ratio	ϵ	17.4
Firing order		1-5-3-6-2-4
Number/arrangement of cylinders		6 inline
Valves	inlet	2
	Exhaust	1
Working method	4-stroke diesel with direct injection	
Combustion method	Exhaust gas turbocharging and charge air cooling	
Injection method	Single unit pump with pump-line-nozzle system (PLD)	
Timing	Electronic engine management with solenoid valve-controlled fuel injection	
Spec. fuel consumption (b)	g/kWh (see chart)	

GF01.00-W-1000-01P	Technical data - engine	Engine 906.940	
--------------------	-------------------------	----------------	---

- P Engine output
- M Engine torque
- n Rated speed
- b Specific fuel consumption

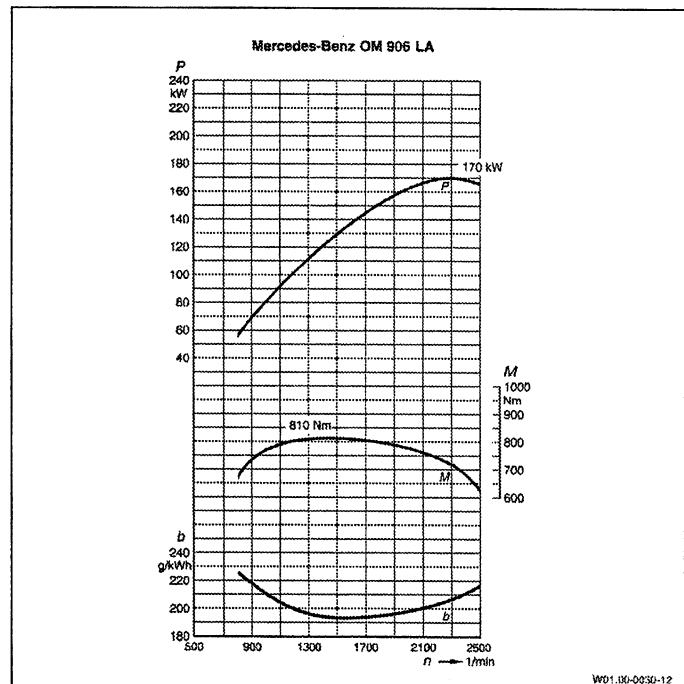

Engine model designation		906.940
Engine type		OM 906 LA
Engine output (P)	kW/hp	170/231
	min ⁻¹	2300
Engine torque (M) max.	Nm	810
	min ⁻¹	1300
Rated speed/upper load speed	min ⁻¹	2300
Bore	mm	102
Stroke	mm	130
Total displacement	cm ³	6370
Compression ratio	ε	17.4
Firing order		1-5-3-6-2-4
Number/arrangement of cylinders		6 inline
Valves	inlet	2
	Exhaust	1
Working method	4-stroke diesel with direct injection	
Combustion method	Exhaust gas turbocharging and charge air cooling	
Injection method	Single unit pump with pump-line-nozzle system (PLD)	
Timing	Electronic engine management with solenoid valve-controlled fuel injection	
Spec. fuel consumption (b)	g/kWh (see chart)	

GF01.00-W-1000-01NA	Technical data - engine	Engine 906.915/925/927/951	
---------------------	-------------------------	----------------------------	---

- P* Engine output
M Engine torque
n Rated speed
b Specific fuel consumption

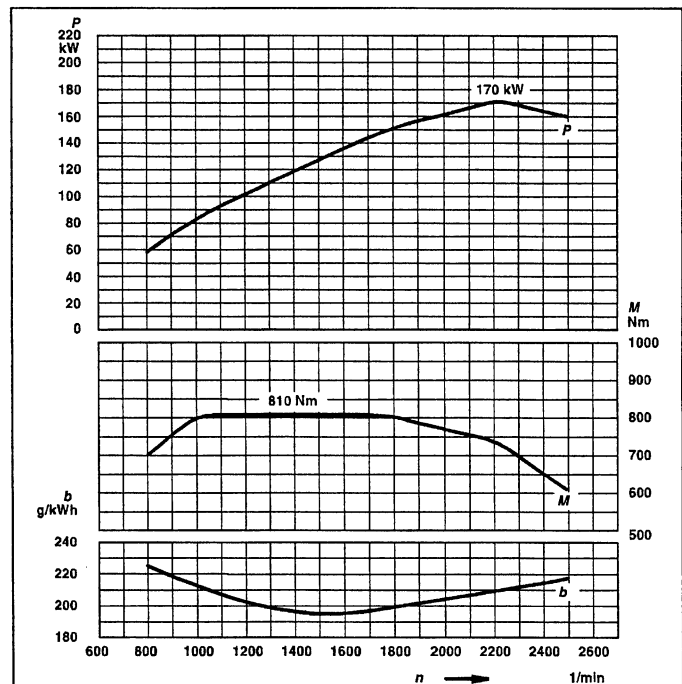

W01.00-1017-12

Engine model designation		906.915/925/927/951
Engine type		OM 906 LA III/2
Engine output (P)	kW/hp	170/231
	rpm	2200
Engine torque (M) max.	Nm	810
	rpm	1200-1600
Rated speed/upper load speed	rpm	2200/2500
Bore	mm	102
Stroke	mm	130
Total displacement	cm ³	6370
Compression ratio	ϵ	18.0
Firing order		1-5-3-6-2-4
Number/arrangement of cylinders		6 inline
Valves	inlet	2
	Exhaust	1
Working method	4-stroke diesel with direct injection	
Combustion method	Exhaust turbocharging and charge air cooling	
Injection method	Single unit pump with pump-line-nozzle system (PLD)	
Engine management	Electronic engine management with solenoid valve-controlled fuel injection	
Specific fuel consumption (b)	g/kWh (see chart)	

GF01.00-W-1000-010	Technical data - engine	Engine 906.911/921/923	
--------------------	-------------------------	------------------------	--

- P* Engine output
- M* Engine torque
- n* Rated speed
- b* Specific fuel consumption

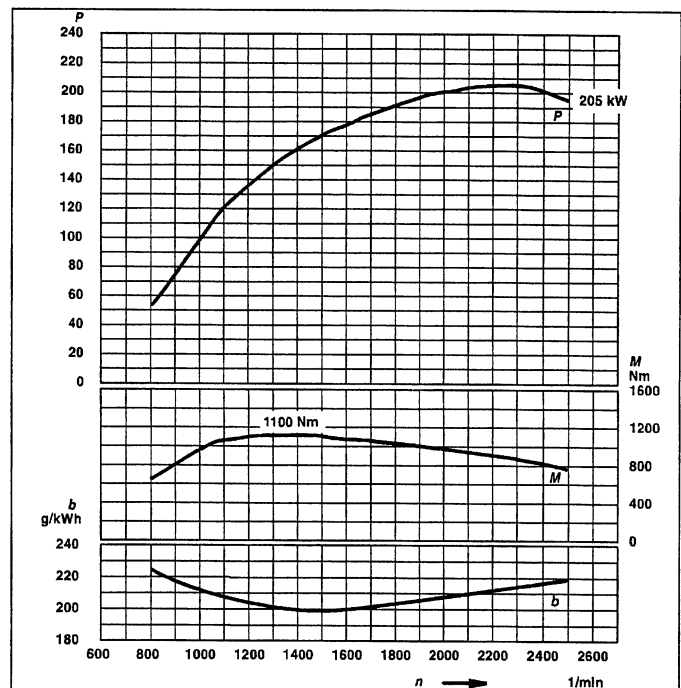

W01.00-0027-12

Engine model designation		906.911/921/923
Engine type		OM 906 LA II/3
Engine output (P)	kW/hp	205/280
	min ⁻¹	2300
Engine torque (M) max.	Nm	1100
	min ⁻¹	1260-1500
Rated speed/upper load speed	min ⁻¹	2300/2500
Bore	mm	102
Stroke	mm	130
Total displacement	cm ³	6370
Compression ratio	ϵ	17.4
Firing order		1-5-3-6-2-4
Number/arrangement of cylinders		6 inline
Valves	inlet	2
	Exhaust	1
Working method	4-stroke diesel with direct injection	
Combustion method	Exhaust gas turbocharging and charge air cooling	
Injection method	Single unit pump with pump-line-nozzle system (PLD)	
Timing	Electronic engine management with solenoid valve-controlled fuel injection	
Spec. fuel consumption (b)	g/kWh (see chart)	

GF01.00-W-1000-01Q	Technical data - engine	Engine 906.941	 GF
--------------------	-------------------------	----------------	--

- P* Engine output
M Engine torque
n Rated speed
b Specific fuel consumption

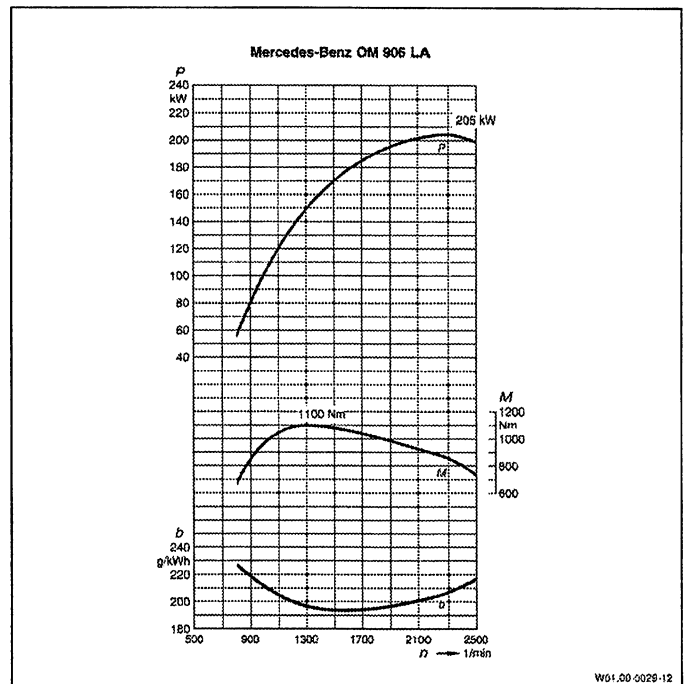

W01.00-0029-12

Engine model designation		906.941
Engine type		OM 906 LA
Engine output (P)	kW/hp	205/280
	min ⁻¹	2300
Engine torque (M) max.	Nm	1100
	min ⁻¹	1300
Rated speed/upper load speed	min ⁻¹	2300
Bore	mm	102
Stroke	mm	130
Total displacement	cm ³	6370
Compression ratio	ϵ	17.4
Firing order		1-5-3-6-2-4
Number/arrangement of cylinders		6 inline
Valves	inlet	2
	Exhaust	1
Working method	4-stroke diesel with direct injection	
Combustion method	Exhaust gas turbocharging and charge air cooling	
Injection method	Single unit pump with pump-line-nozzle system (PLD)	
Timing	Electronic engine management with solenoid valve-controlled fuel injection	
Spec. fuel consumption (b)	g/kWh (see chart)	

Engine 906 longitudinal section

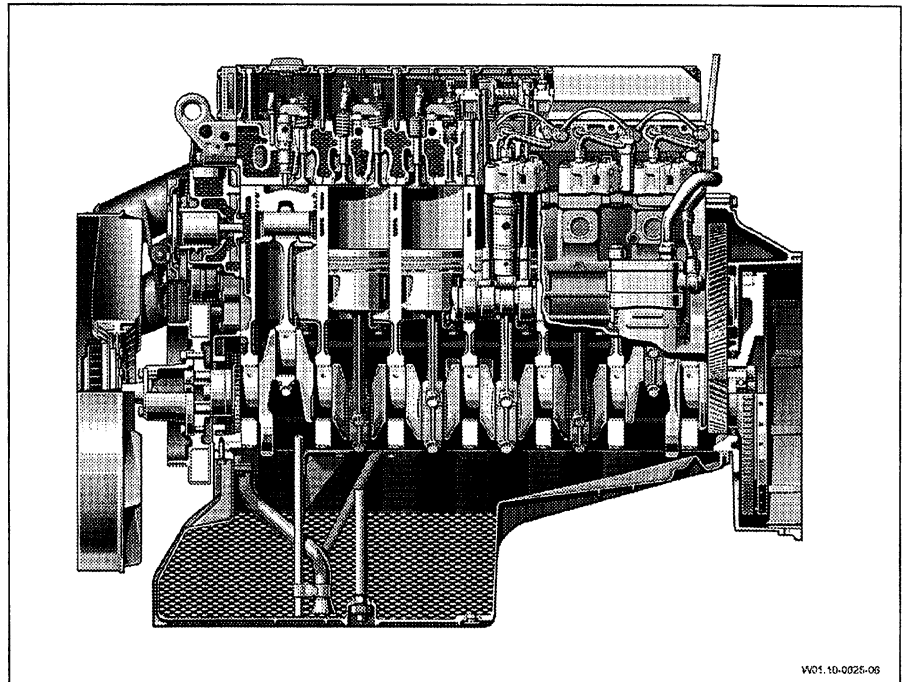

W01.10-0025-06

W01.10-0025-06

Engine 906 transverse section

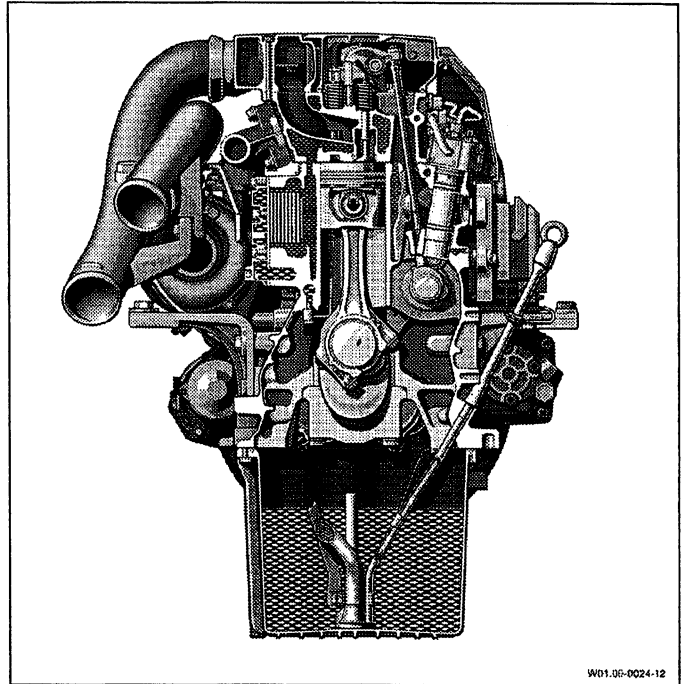

W01.05-0024-12

W01.10-0024-12

GF01.00-W-1000-010A	Technical data - engine	Engine 906.916/926/928/952	GF
---------------------	-------------------------	----------------------------	----

- P* Engine output
- M* Engine torque
- n* Rated speed
- b* Specific fuel consumption

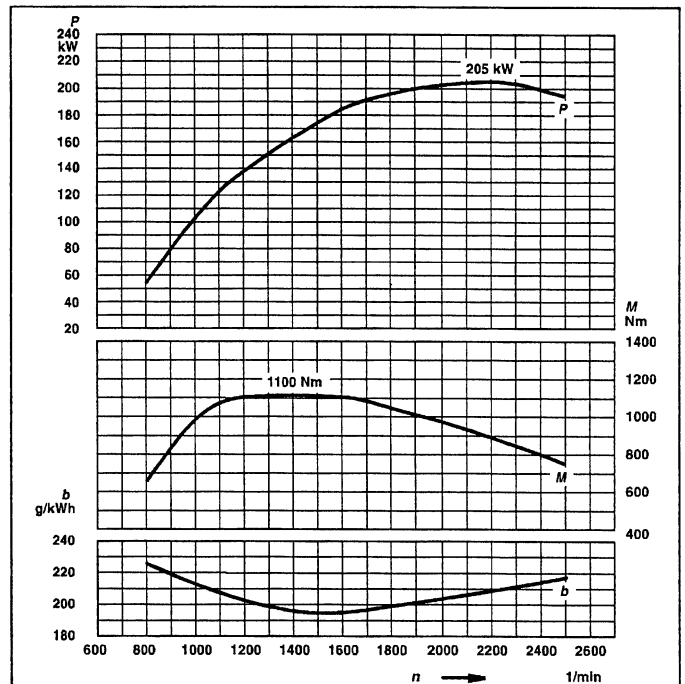

W01.00-1019-12

Engine model designation		906.916/926/928/952
Engine type		OM 906 LA III/4
Engine output (P)	kW/hp	205/280
	rpm	2200
Engine torque (M) max.	Nm	1100
	rpm	1200-1600
Rated speed/upper load speed	rpm	2200/2500
Bore	mm	102
Stroke	mm	130
Total displacement	cm ³	6370
Compression ratio	ϵ	18.0
Firing order		1-5-3-6-2-4
Number/arrangement of cylinders		6 inline
Valves	inlet	2
	Exhaust	1
Working method	4-stroke diesel with direct injection	
Combustion method	Exhaust turbocharging and charge air cooling	
Injection method	Single unit pump with pump-line-nozzle system (PLD)	
Engine management	Electronic engine management with solenoid valve-controlled fuel injection	
Specific fuel consumption (b)	g/kWh (see chart)	

GF01.00-W-1000-01SA	Technical data - engine	Engine 906.939	
---------------------	-------------------------	----------------	--

- P* Engine output
- M* Engine torque
- n* Rated speed
- b* Specific fuel consumption

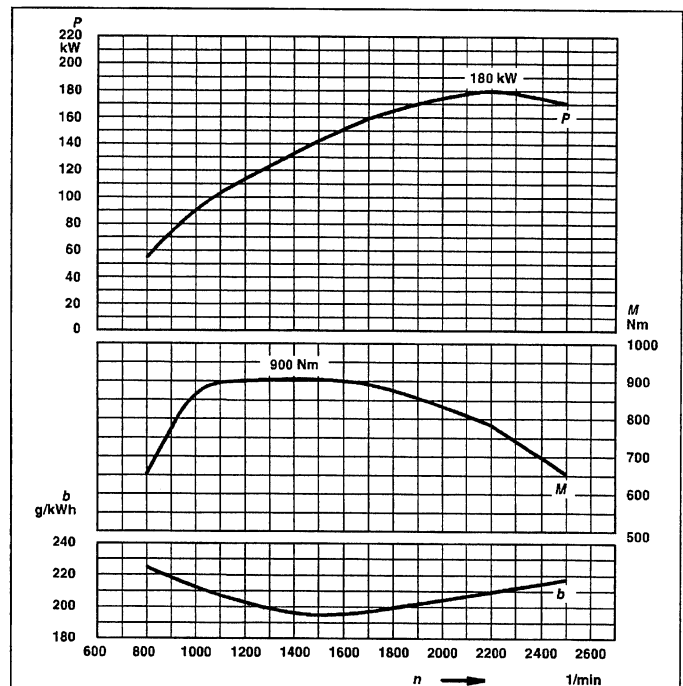

W01.00-1018-12

Engine model designation		906.939
Engine type		OM 906 LA III/3
Engine output (P)	kW/hp	180/245
	rpm	2200
Engine torque (M) max.	Nm	1100
	rpm	1260-1500
Rated speed/upper load speed	rpm	2200/2500
Bore	mm	102
Stroke	mm	130
Total displacement	cm ³	6370
Compression ratio	ϵ	18.0
Firing order		1-5-3-6-2-4
Number/arrangement of cylinders		6 inline
Valves	inlet	2
	Exhaust	1
Working method	4-stroke diesel with direct injection	
Combustion method	Exhaust turbocharging and charge air cooling	
Injection method	Single unit pump with pump-line-nozzle system (PLD)	
Engine management	Electronic engine management with solenoid valve-controlled fuel injection	
Specific fuel consumption (b)	g/kWh (see chart)	

GF01.00-W-1000-01R	Technical data - engine	Engine 906.920/ 922	
--------------------	-------------------------	---------------------	---

- P* Engine output
- M* Engine torque
- n* Rated speed
- b* Specific fuel consumption

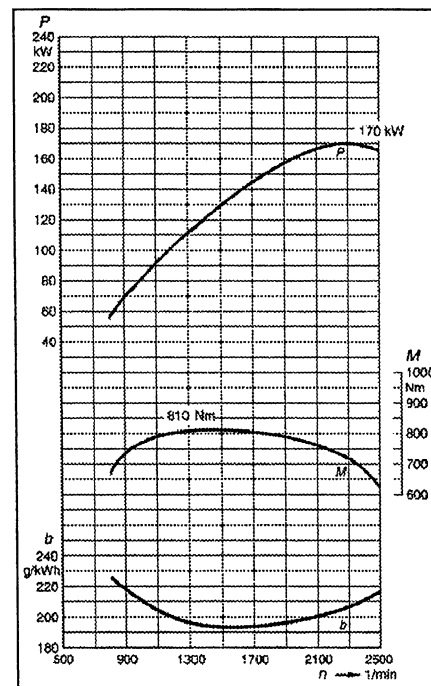

W01.00-0032-03

Engine model designation		906.920/922
Engine type		OM 906 LA
Engine output (P)	kW/hp	170/231
	rpm	2300
Engine torque (M) max.	Nm	810
	rpm	1300
Rated speed/upper load speed	rpm	2300
Bore	mm	102
Stroke	mm	130
Total displacement	cm ³	6370
Compression ratio	ϵ	17.4
Firing order		1-5-3-6-2-4
Number/arrangement of cylinders		6 inline
Valves, number / play (inspection tolerance)	inlet	2 / 0.40 mm (+ 20/-10 mm)
	Exhaust	1 / 0.60 mm (+ 20/-10 mm)
Working method	4-stroke diesel with direct injection	
Combustion method	Exhaust turbocharging and charge air cooling	
Injection method	Single unit pump with pump-line-nozzle system (PLD)	
Engine management	Electronic engine management with solenoid valve-controlled fuel injection	
Specific fuel consumption (b)	g/kWh (see chart)	
Oil filling capacity	max.	29 l
	min.	24 l

ENGINE 906.920 /921 /922 /923 /925 /926 /927 /928 /942 /943

- 1 Cab-chassis plug connection
 2 Cover
 3 Red cable
 4 Engine wiring harness

- X.2.1 Plug connector
 X.2.2 Plug connector
 X.2.3 Plug connector

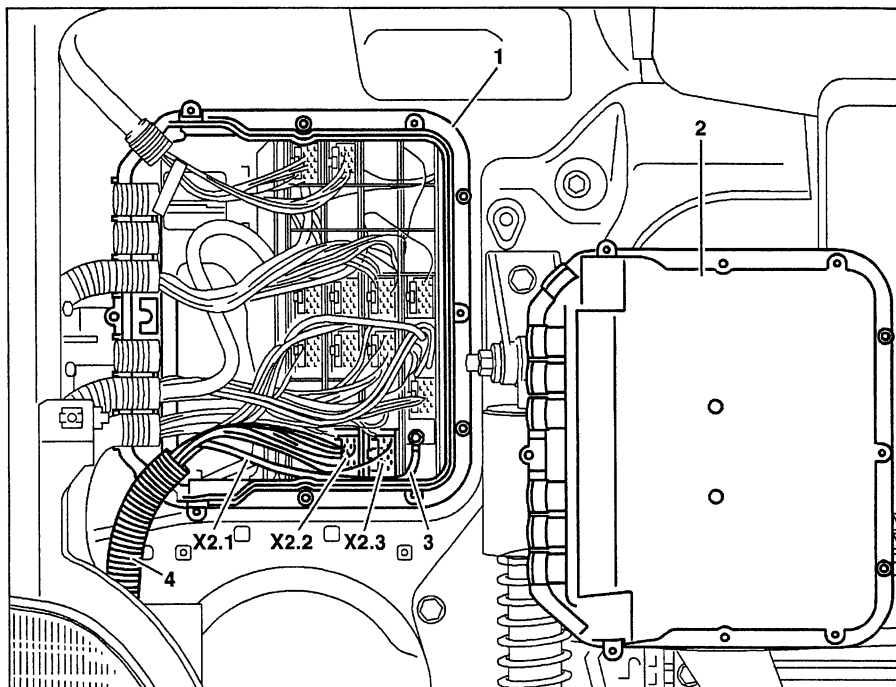

W01.00-1001-06

	Removal, installation		
Danger!	Risk of explosion from explosive gas. Risk of poisoning and caustic burns from swallowing battery electrolyte. Risk of injury from caustic burns to eyes and skin from battery electrolyte or from handling damaged lead acid batteries.	No fire, sparks, naked flames or smoking. Wear acid-protective gloves, clothing and eye protection. Pour battery electrolyte only into suitable and appropriately marked containers.	Page 22
1	Disconnect battery		
	Notes on battery	All models	Page 24
2	Open service flap		
3	Remove front grille		000 589 01 10 00
4	Take off cover (2) at cab-chassis plug connection (1)	Installation: Cover of cab-chassis plug connection must be closed leaktight. 	000 589 01 10 00
5	Separate red cable (3) and plug connector (X.2.1 to X.2.3) at cab-chassis connection point (1)		
6	Unclip engine wiring harness (4) and place down	Do not damage engine wiring harness.	
Danger!	Risk of injury from hand being jammed and bruised when tilting cab	No person must be within the tilting range of the cab when the cab is tilted. Always tilt cab as far as the end position and secure with safety prop.	Page 24
N	Tilt cab		
	Notes on tilting cab	Model 375, 950, 952, 953, 954	Page 25

8	Detach engine wiring harness (4) at the fixture of the right frame longitudinal member and tie up at engine	ⓘ Do not damage engine wiring harness.	
9	Install in the reverse order		
10	Set time at tachograph		

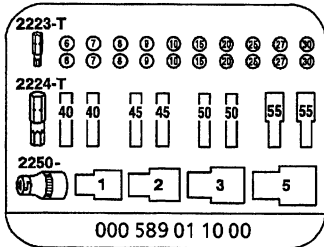

Torx bit set

AS54.10-Z-0001-01A	Explosion hazard from explosive gas. Danger of poisoning and acid burns when battery acid is swallowed. Danger of acid burns to skin and eyes from battery acid or when handling damaged lead-acid batteries.	Flames, sparks, open light and smoking prohibited. Wear acid resistant gloves, clothing and goggles. Store battery acid only in suitable, appropriately marked containers.	⚠ Danger!
--------------------	---	--	-----------

Possible dangers

Explosion hazard

A highly explosive gas mixture is generated when lead-acid batteries are charged

Poisoning hazard

When battery acid is taken orally toxic symptoms can occur such as headache, dizziness, stomach pain, paralysis of the respiratory system, unconsciousness, vomiting, acid burns and cramps. Battery acid vapor can burn eyes. Inhalation can result in burns to mucous membranes and respiratory paths. Lead in the body can damage blood, nerves and kidneys; moreover, lead compounds pose a hazard for the reproduction organs.

Injury hazard

Battery acid contains sulfuric acid, which can cause severe burns to skin and eyes. When handling damaged lead-acid batteries (removing from accident vehicle) increased care is necessary due to the sharp edges on the broken housing and direct contact with the lead plates.

Rules of behavior/protective measures

- Charge lead-acid batteries only in well ventilated rooms.
- Fire, sparks, open light and smoking prohibited.
- Do not lay tools or other conductive items on lead-acid batteries (danger of short circuiting).
- Disconnect and remove lead-acid batteries for charging.
- Always disconnect negative pole first; always connect positive pole first.
- Switch on charger only after connecting to poles; switch off before disconnecting.

- Keep lead-acid batteries and battery acid away from unauthorized persons.
- Store battery acid only in suitable, appropriately marked containers.
- Store lead-acid batteries only in upright position.
- Ensure that gassing line is properly connected.
- Check gassing line for kinks and proper passage.
- Observe instructions for applicable lead-acid battery and vehicle operating instructions.
- Wear acid protective clothing and protective goggles with side guard.

First-aid measures

Eye contact

- Rinse eyes immediately with large quantities of water.

Skin contact

- Remove affected clothing.
- Neutralize acid on skin or clothing immediately with acid neutralizer or soap solution and rinse with large quantities of water.

Inhalation of battery acid vapor

- Move affected person to fresh air

Swallowing battery acid

- Have person drink large quantities of water containing activated charcoal.

Generally medical services or a physician should be contacted after administering first aid.

Fire protection measures

Suitable extinguishing agents

- CO₂ and dry extinguishing agents.

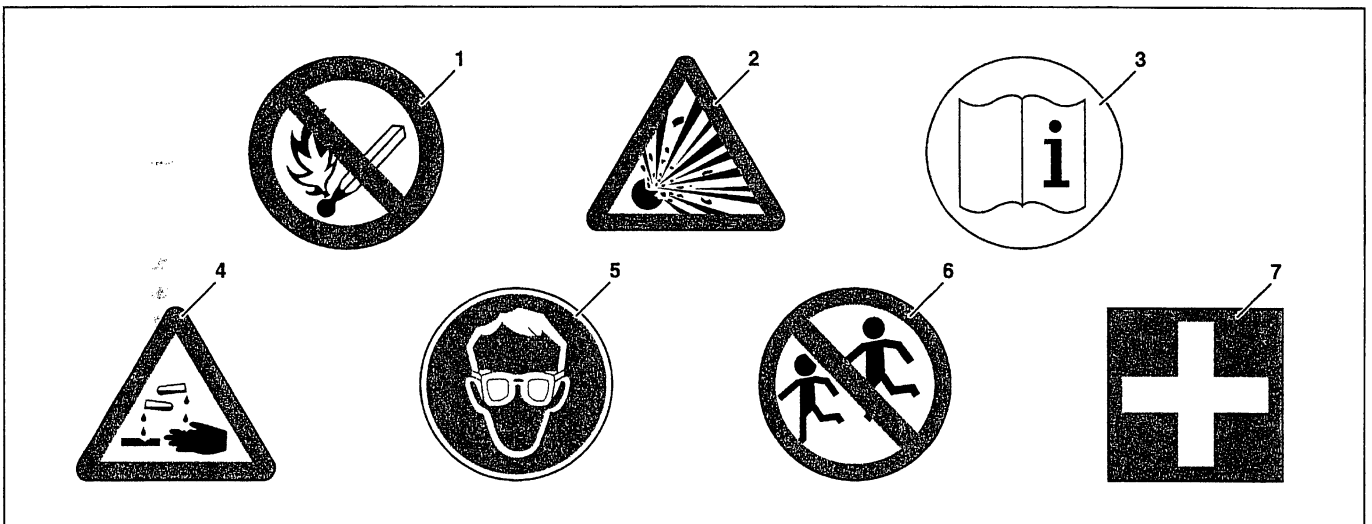

P54.10-0270-08

Warning notes on lead acid batteries

- | | | | | | |
|---|---|---|--------------------------------|---|-------------------------|
| 1 | Fire, sparks, open light and smoking prohibited | 3 | Observe operating instructions | 6 | Keep away from children |
| 2 | Explosion hazard | 4 | Danger of acid burns | 7 | First aid |
| | | 5 | Wear eye protection | | |

AH54.10-P-0001-01A	Notes on battery	All models	
--------------------	------------------	------------	---



- Do not store lead-acid batteries for extended periods of time in a place where they are exposed to direct sunlight.
- Always store lead-acid batteries horizontally to prevent acid from escaping; do not tilt them when they are being transported.
- Discharged or faulty lead-acid batteries can freeze up; therefore, ensure that they are stored at temperatures above freezing level.
- Do not place any tools or other electrically conductive objects on a lead-acid battery (risk of short-circuit!).
- Avoid mixing up positive and negative poles and avoid short-circuits.
- Before removing or installing a lead-acid battery, switch off all electrical consumers where possible, and switch off the engine, so as to minimize the possibility of creating sparks.
- Always disconnect the negative pole first; always connect the positive pole first.

- Do not switch on battery chargers until they have been connected to the battery poles; switch them off before disconnecting.
- Only charge lead-acid batteries with direct current. For the charging current we recommend 10% of capacity for normal charging and 50% of capacity for rapid charging.
- During rapid charging it must be insured that the casing of the lead-acid battery does not warm up excessively (< 55 °C).
- Lead-acid batteries should be kept clean and dry as far as possible.
- It is advisable to grease the poles lightly with battery pole grease.
- Lead-acid batteries should not be stored for extended periods without being recharged.
- If a lead-acid battery is to remain in a vehicle which is not in use for an extended period, the negative terminal clamp should be disconnected.

AS60.80-Z-0001-01A	Injury hazard from pinching and crushing when cab is tilted	When tilting ensure that no one is present in the tilting area of the cab. Always tilt cab to end position and secure with safety brace.	 Danger!
--------------------	---	--	--

Injury hazard

A damaged tilting mechanism or improper handling of the tilting mechanism can lead to severe injuries when tilting the cab.

Rules of behavior/protective measures

Before tilting cab:

- Shut off engine.
- Apply parking brake.
- Secure vehicle against rolling.
- On vehicles with manual transmission, move shift lever to neutral position.
- On vehicles with automatic transmission, move selection lever to position "N":

When tilting the cab:

- Protect tilting area and particularly tilting device against unauthorized access, e.g. by blocking off or with human guard.
- Attach safety cable before tilting when so specified in the vehicle operating instructions.
- Never work under cab when partially tilted.
- Always tilt cab to end position and secure with safety brace.

AH60.80-N-0003-01A	Notes on tilting cab	Model 375, 673, 674, 675, 676, 677, 678, 679, 684, 950, 952, 953, 954, 957, 970, 971, 972, 973, 974, 975, 976	
--------------------	----------------------	---	---

Prior to tilting cab:

- Switch off engine
- Apply parking brake
- Secure vehicle to prevent it moving off
- Remove all loose objects (e.g. cans, bottles, tools, bags etc.) from the cab
- Models fitted with manual transmission: move shift lever into Neutral
- Model 957: unlock steering column and open front flap.

Models fitted with refrigeration compartment

- The refrigeration compartment must be switched off before tilting the cab.
- The refrigeration compartment must not be switched on again until 10 minutes after tilting back the cab.
 Refer also to operating instructions of refrigeration compartment manufacturer and red information sticker on the refrigeration compartment.

The front coupling pin must be correctly inserted.



- Always tilt cab as far as the end position.
- After tilting cab, support with a prop.
- If no resistance can be felt when operating the cab tilting pump, check whether sufficient oil is present in the tilting pump.
- If a firm resistance can be felt when operating the cab tilting pump, check whether the valve lever at the tilting pump is in the desired tilting direction.

30

ENGINES 904.909 /910 /911 /915 /916 /917 /922, 906.910 /911 /915 /916

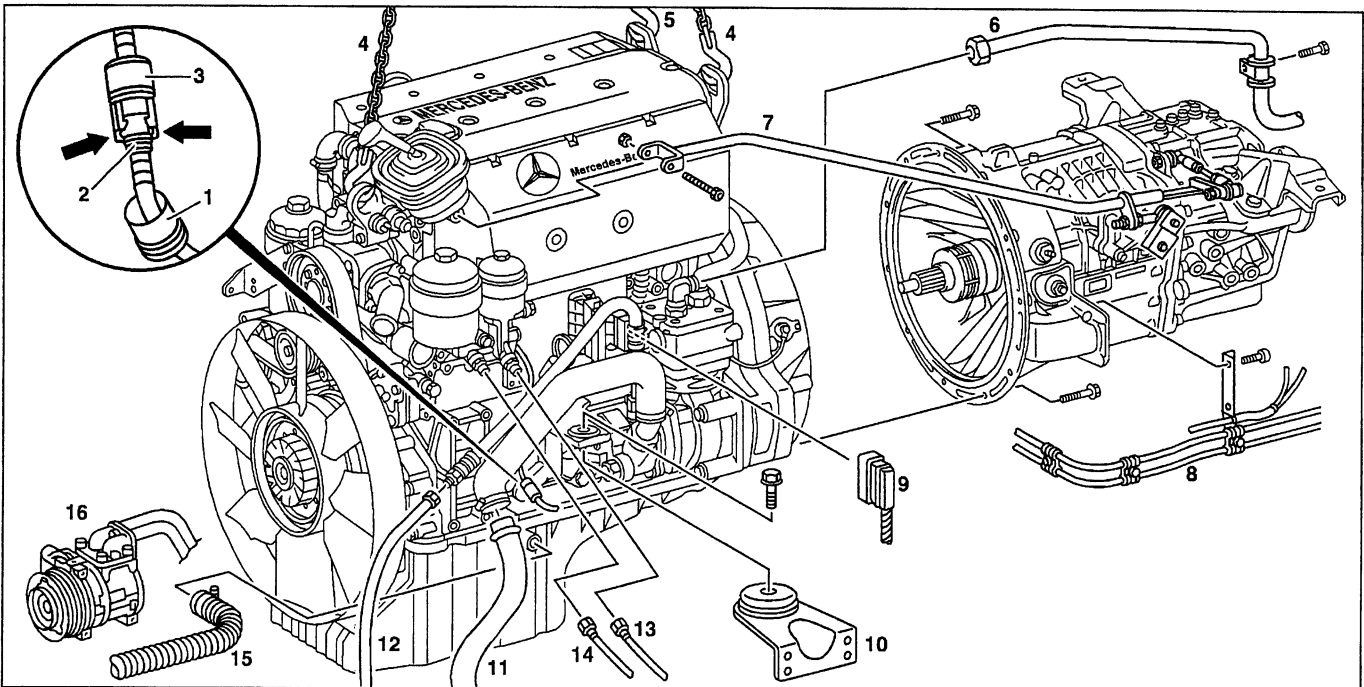

W01.10-0014-09

- | | | | |
|---|--|----|----------------------------------|
| 1 | Cap (on engines 904.909- 911/915-917/922) | 8 | Cable harness, cable and bracket |
| 2 | Coupling, compressed air line
(on engines 904.909- 911/915-917/922) | 9 | Connector (control module) |
| 3 | Plug, compressed air line
(on engines 904.909- 911/915-917/922) | 10 | Engine mount |
| 4 | Engine hoist | 11 | Steering line (return flow) |
| 5 | Chain tackle | 12 | Steering line (pressure) |
| 6 | Compressed-air line (compressor) | 13 | Fuel line (feed) |
| 7 | Shift rod (on engines 904.909- 911/915-917/922) | 14 | Fuel line (return flow) |
| | | 15 | Oil filler pipe |
| | | 16 | Refrigerant compressor |

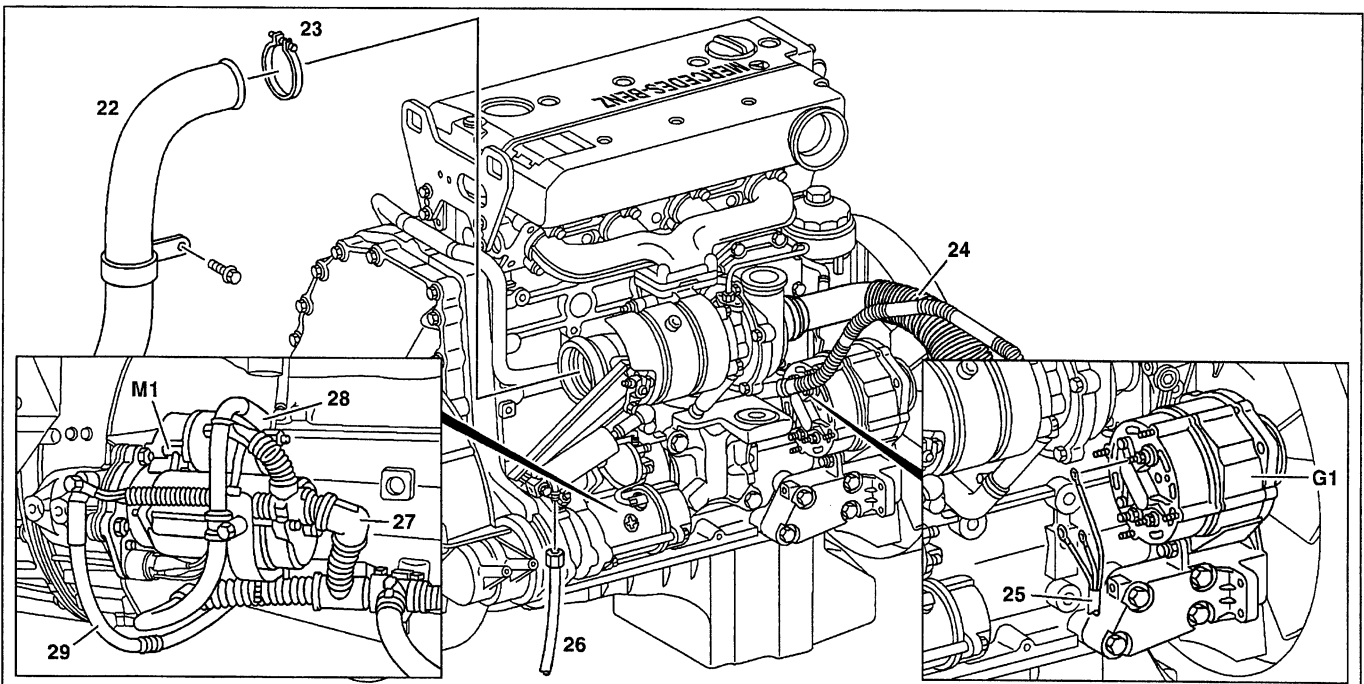

W01.10-0012-09

- 22 Exhaust pipe
- 23 Clamp
- 24 Air intake house
- 25 Electric cable (generator)
- 26 Compressed air line (engine brake cylinder)
- 27 Cable harness

- 28 Starter cable
- 29 Ground cable

- G1 Generator
- M1 Starter

On engines 906.910/911/915/916



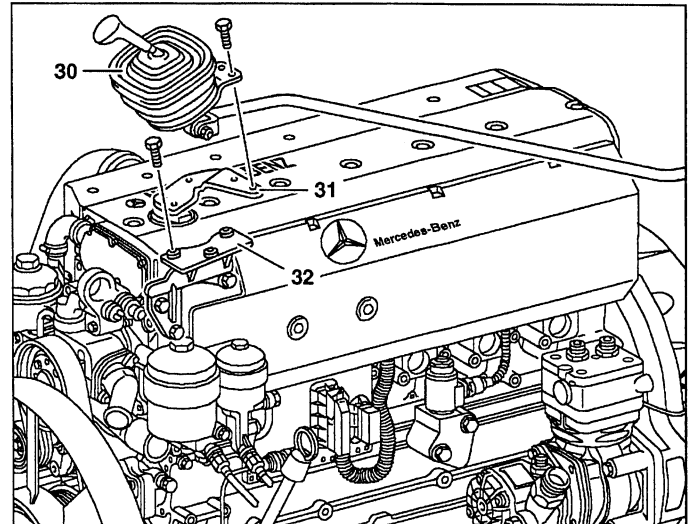





- 30 Gearshift lever with gearshift linkage
- 31 Bracket
- 32 Support















W01.10-0017-11

Modification notes

10.11.99	Set time at tachograph	Step 31 added	
----------	------------------------	---------------	--

	Removing, installing		
	Replace all self-locking nuts and bolts		
 Danger!	Risk of explosion from explosive gas. Risk of poisoning and caustic burns from swallowing battery electrolyte. Risk of injury from caustic burns to eyes and skin from battery electrolyte or from handling damaged lead acid batteries.	No fire, sparks, naked flames or smoking. Wear acid-protective gloves, clothing and eye protection. Pour battery electrolyte only into suitable and appropriately marked containers.	Page 22
1	Disconnect battery		
	Notes on battery	All models	Page 24
 Danger!	Risk of injury from hand being jammed and bruised when tilting cab	No person must be within the tilting range of the cab when the cab is tilted. Always tilt cab as far as the end position and secure with safety prop.	Page 24
2	Tilt cab into repair position		
	Notes on tilting cab	Models 375, 970- 976	Page 25
3	Remove noise encapsulation panels		
4	Remove charge air pipe from charge air cooler to charge air manifold		AR09.41-W-1311D
5	Remove charge air pipe from turbocharger to charge air cooler		AR09.41-W-1311C
6	Remove fan shroud		AR20.40-W-6800A
7	Detach oil filler line (15) at oil pan and tie up at frame		
8	Detach exhaust pipe (22) at engine brake flap connection and at transmission	 Secure exhaust pipe on frame.  Installation: Clean sealing surfaces	

9	Detach compressed air line (26) at engine brake cylinder		
10	Detach air intake hose (24) at air cleaner housing		
11	Disconnect electrical cable at flame glow plug and at solenoid valve		
12	Disconnect electric cable (28) at starter (M1) and wiring harness (27) at bracket		
13	Disconnect electric cable (25) at generator (G1) and at bracket	 Pay attention to color coding	
14	Disconnect ground cable (29) and wiring harness at timing case		
15	Unbolt compressed air line (6) at compressor and inspect for carbon deposits	 If carbon deposits are present, the compressed-air line between compressor and compressed-air drier and the four-circuit protection valve must additionally be inspected. Replace parts with carbon deposits.  Installation: Inspect compressed air line for leaks.	
16.1	Detach shift linkage (7) at shift lever	Only with engines 904.909-911/915-917/922	
16.2	Detach shift lever together with shift linkage (30) and bracket (31) at carrier (32)	Only with motors 906.910/911/915/916	
 Danger!	Risk of explosion from ignition, risk of poisoning from inhaling and swallowing fuel as well as risk of injury from skin and eye contact with fuel.	No fire, sparks, naked flames or smoking. Pour fuels only into suitable and appropriately marked containers. Wear protective clothing when handling fuel.	Page 30
17	Separate fuel lines (13, 14) at fuel filter	 Collect fuel which flows out. Mark fuel lines.	
18	Slacken poly V-belt and take off	 Only on models fitted with air conditioning.	AR13.22-W-1202A
19	Detach refrigerant compressor (16) together with bracket at engine	 Do not separate refrigerant lines.	
20	Separate compressed air lines (2, 3) of constant throttle	 On engines 904.909-911/915-917/922 with constant throttle only. Pull off cap (1), press clamp apart using pliers and pull connector out of socket.	
 Danger!	Risk of injury to skin or eyes from hydraulic fluid spraying out under pressure. Risk of poisoning from swallowing hydraulic fluid.	Render the hydraulic system pressureless before commencing work on system. Wear protective clothing and eye protection.	Page 31
21	Separate both hoses at the steering lines (11, 12)	 Collect hydraulic oil which flows out  Installation: Top up hydraulic fluid and if necessary ↓ bleed steering.	AP46.00-W-4611A AR46.25-W-3300A
22	Release and separate connector of cable harness (9) on MR/PLD control unit		
23	Attach transmission or support		
24	Unscrew bolts at transmission	 Transmissions 710.621/622/623/626/627  Transmissions 715.050/060/320	BA26.10-N-1006-01B BA26.10-N-1001-01C

25	Remove bolts at both engine mounts (10)	Inspect engine mounts for wear, replace if necessary.	
26	Remove engine with removal fixture		Page 31 WH58.30-Z-1001-07A BR00.45-Z-1002-06A
27	Install in the reverse order		
28	Reprogram transponder key (also spare key)	Only if a reconditioned engine or a new MR/PLD control unit is installed	AR80.57-W-0010A
29	Check engine-oil level via electrical indicator and if necessary correct	See operating instructions part 3	
30	Check coolant level and if necessary adjust to correct level		AP20.00-W-2010A
Danger!	Risk of accident from vehicle starting off by itself when engine running. Risk of injury from bruises and burns if you hold your hand into engine when it is started or when it is running.	Secure vehicle to prevent it moving off by itself. Wear closed and close-fitting work clothes. Do not grasp hot or rotating parts.	Page 33
31	Start engine	Do not rev up engine as long as no oil pressure is indicated The oil pressure gage must indicate oil pressure after about 10 seconds	BE18.00-N-1001-01C
32	Switch off engine		
33	Inspect engine, cooling system and steering hydraulics for leaks	Visual check.	
34	Set time at tachograph		
35	Enter engine number in FDOK "Screen 1111"	Only if reconditioned engine is installed.	

Test data of engine oil pressure

Number	Designation	Engines 904.9, 906.9
BE18.00-N-1001-01C	Engine oil pressure at	Idle speed bar ≥ 0.5
		Maximum speed bar ≥ 2.5

Manual transmission complete

Number	Designation	Transmissions 710.621/622/623/626/627/68
BA26.10-N-1006-01B	Transmission to flywheel housing	Nm 45

Manual transmission complete

Number	Designation	Trans- mission 715.050	Trans- mission 715.060	Trans- missions 715.320/ 715.321
BA26.10-N-1001-01C	Transmission to flywheel housing	Nm 45	45	45

Commercially available tools (see Workshop Equipment Manual)

Number	Designation	Make (e. g.)	Order no.
WH58.30-Z-1001-07A	Engine hoist (self-locking)	Bäcker Herderstraße D-42853 Remscheid	3 188

Repair products

Number	Designation	Order no.
BR00.45-Z-1002-06A	MB long-term grease	000 989 63 51

AS47.00-Z-0001-01A	Fuel vapors present an explosion hazard. Fuel is toxic when inhaled or swallowed. Contact with fuel can cause skin and eye injury.	No fire, sparks, naked flames or smoking. Pour fuels only into suitable and appropriately marked containers. Wear protective clothing when handling fuel.	 Danger!
--------------------	--	--	--

Possible hazards

Risk of explosion, poisoning and injury

Fuels are easily flammable and poisonous when swallowed. Fuel can cause skin damage. For example, contact with gasoline fuel removes the natural oils of the skin. Fuel vapors are explosive, invisible and disperse on the ground. They are poisonous if inhaled and have a narcotic effect if they are present in high concentrations.

- Store drained fuel in suitable and sealed containers.
- Immediately eliminate fuel which has poured out.

Carrying out work on a vehicle with a naked flame (e.g. welding, etc.)

- Before commencing such work, remove the relevant parts of the fuel system and seal any open fuel lines with plugs.

Protective measures/rules of conduct

- Observe the safety precautions and regulations applicable in the specific country.
- No fire, sparks, naked flames or smoking.
- Ensure that the work place is adequately ventilated.
- Never drain or pour in fuels above assembly pits.

First-aid measures

- Clean moistened skin with soap and water.
- Change moistened clothing as rapidly as possible
- If fuel gets into the eyes, immediately rinse out the eyes with water; contact a doctor, if necessary.

AS00.00-Z-0013-01A	Risk of injury to skin or eyes from pressurized hydraulic fluid spraying out. Risk of poisoning from swallowing hydraulic fluid	Before starting work on the hydraulic system, depressurize the system. Wear protective clothing and safety glasses.	 Danger!
--------------------	--	---	---

Potential danger

Risk of injury

Serious injuries can be caused to the skin or eyes when loosening hydraulic lines without depressurizing the system beforehand, due to the very high pressures (above 200 bar). Damage to the skin may be caused if unprotected skin comes into contact with hydraulic fluid, particularly central hydraulic fluid (this is especially harmful to health).

Risk of poisoning

Anyone who swallows hydraulic fluid can expect to suffer symptoms of poisoning including headaches, dizziness, stomach ache, vomiting, diarrhoea, cramps and unconsciousness

Safety measures/operating instructions

- Before starting work on hydraulic systems they should be depressurized and the system must be emptied if necessary.
- Do not pour hydraulic fluid into drinking containers.
- Ensure adequate ventilation, particularly in the case of central hydraulic fluid.

- Ensure only authorized persons have access to hydraulic fluid.
- Seal disconnected lines and hoses and connections on the subassemblies immediately with blind plugs.
- Wear safety gloves, protective clothing and safety glasses. If it is not possible to wear safety gloves, the following points are to be observed:
 - Only allow hydraulic fluid to come into contact with the skin for as short a time as possible, wash fluid off skin with soap and water.
 - Change wet clothing as quickly as possible

First aid

- Have the casualty drink plenty of water with activated charcoal additive.
- After swallowing larger quantities, consult a doctor.
- If hydraulic fluid gets into the eyes, rinse out the eyes immediately with plenty of clean water/using a eye rinsing glass.
- In the event of injuries to skin or eyes from a jet of hydraulic fluid, consult a doctor immediately.

AR01.10-W-2400-01B	Removing and installing engine with removal fixture	Engine without transmission	
--------------------	---	-----------------------------	--

Commercially available tools (see Workshop Equipment Manual)

Number	Designation	Make (e. g.)	Order no.
WH58.30-Z-1001-07A	Engine hoist (self-locking)	Bäcker Herderstraße D-42853 Remscheid	3188

Repair products

Number	Designation	Order no.
BR00.45-Z-1001-06A	MB long-term grease	000 989 63 51

- 1 Attach engine hoist (1) to the lifting eyes (2 and 3).
- 2 Attach chain block (4) at the rear right of the lifting eye (3) and tension chains at engine hoist (1) and at chain block. Secure engine to prevent it tilting.
- 3 Push engine sufficiently far away from transmission until the transmission shaft is pulled out of the clutch plate.
- 4 Lift out engine.

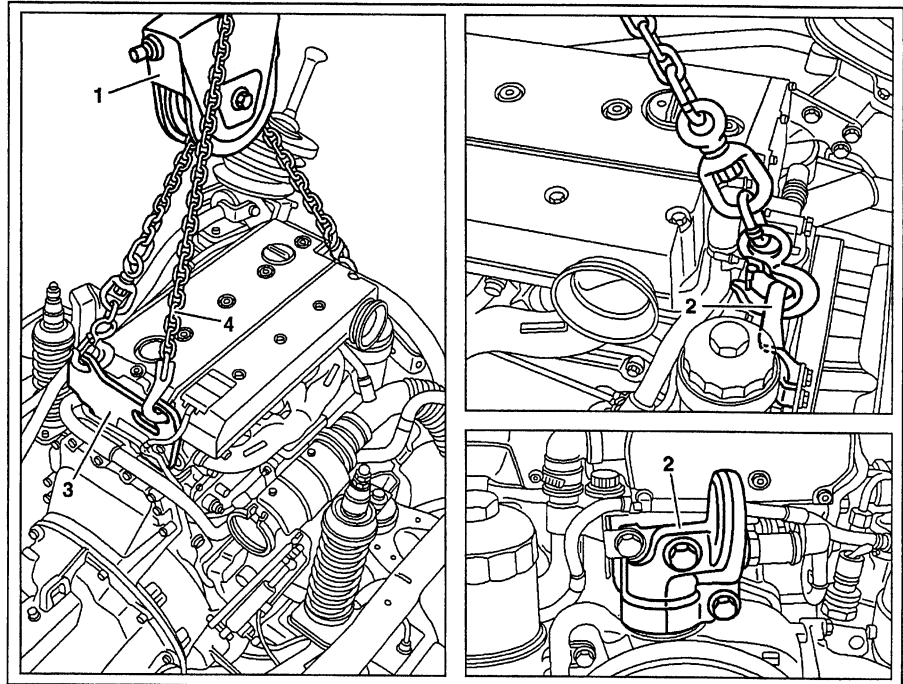

W01.10-0011-06

- 5 Before installing engine, lightly grease transmission shaft.
- 6 Lift engine into the frame and align relative to transmission
- 7 Attach engine to the transmission.

i Ensure that the internal spline of the clutch plate is matched up with the spline of the transmission shaft, rotate starter ring gear, if necessary.

AS00.00-Z-0005-01A	Risk of accident as a result of vehicle starting off when engine is running. Risk of injury as a result of bruises and burns if you insert your hands into engine when it is being started or when it is running.	Secure vehicle to prevent it from moving off. Wear closed and close-fitting work clothes. Do not grasp hot or rotating parts.	 Danger!
--------------------	---	---	--

Possible dangers

Risk of accident

from vehicle starting off during starting operation (e.g. when testing compression pressure) as a result of gear engaged or when engine running and vehicles with automatic transmission as a result of selector lever position "P" or "N" not engaged (exception: some vehicles do not have a selector lever position "P").

Risk of injury

Severe injuries may be caused by freely rotating parts in the area of the running engine. The heat produced by the engine when it is operating can result in severe burns if contact is made with individual, unshielded parts.

Rules of conduct / Protective measures

- As a general rule, carry out work on the running engine only if this is absolutely essential.
- Before starting the engine, apply parking brake.
- On models with manual transmission, move gearshift lever into Neutral position.
- On models with automatic transmission, move selector lever into position "P" or "N" (exception: some vehicles do not have a selector lever position "P").
- On models which do not have selector lever position "P", secure selector lever to prevent it from being operated unintentionally.
- Wear closed and close-fitting work clothes.
- Take off any jewelry, such as chains, rings etc.
- If you have long hair, wear a suitable head cover.
- Before commencing work on the running engine, check to obtain a general picture of the positioning of parts which may be hot.
- When carrying out work when starting the engine or when engine is running, do not touch any hot and rotating parts.

First aid measures in the event of burns

- Do not rub the skin areas affected; flush with plenty of cold water and cover skin with sterile bandages.
- Immediately consult a physician.

ENGINES 906.920 /921 /922 /923 /925 /926 /927 /928 /942 /943

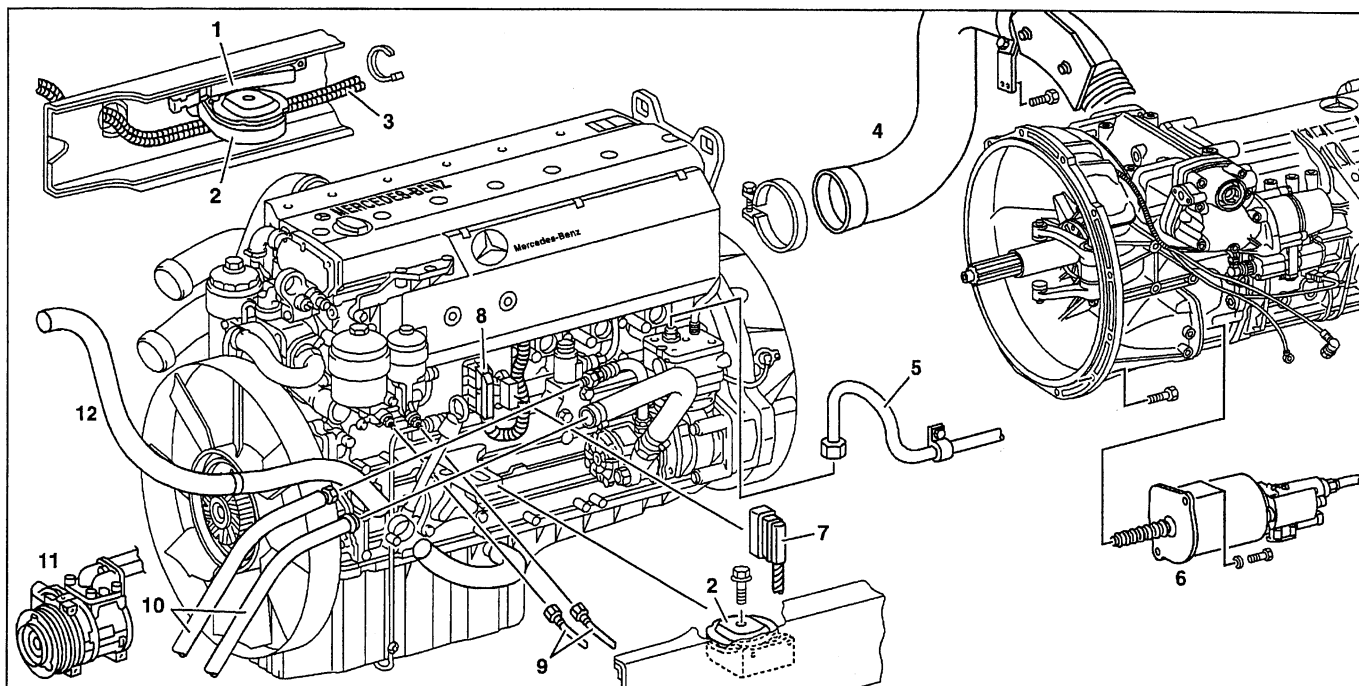

W01.10-1002-09

- | | |
|------------------------------------|--|
| 1 Bracket in frame | 7 Plug connector (cable harness) |
| 2 Engine mount | 8 Plug connector (engine cable harness) |
| 3 Cable harness | 9 Fuel line |
| 4 Exhaust pipe | 10 Hydraulic oil line (steering system) |
| 5 Compressed air line (compressor) | 11 Refrigerant compressor (air conditioning) |
| 6 Clutch servo unit | 12 Oil filler line |

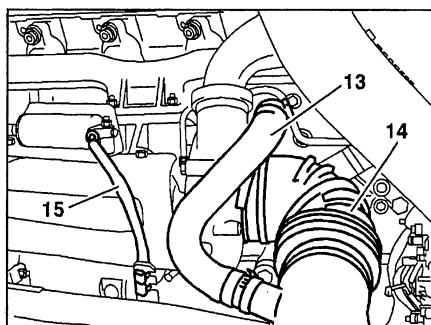

W01.10-1003-01

- | |
|---|
| 13 Crankcase ventilation hose |
| 14 Air intake hose with air intake line |
| 15 Compressed-air line (engine brake) |

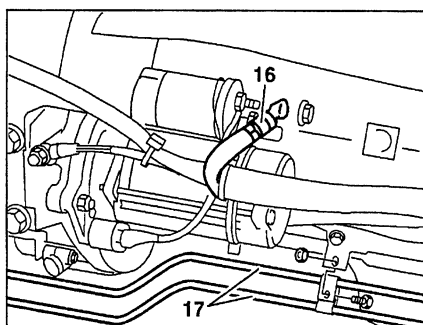

W01.10-1004-01

- | |
|--------------------------|
| 16 Starter cable |
| 17 Transmission oil line |

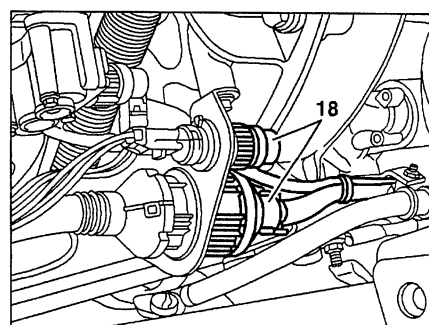

W26.19-1001-01















- | |
|---|
| 18 Plug connector
(transmission cable harness) |
|---|





Modification notes

11.4.00	Value changed from 57 Nm to 60 Nm	Value changed in BA26.60-N-1009-01D on transmission 715.060 with code G53	BA26.60-N-1009-01D
---------	-----------------------------------	---	--------------------

	Removal, installation		
	Installation	Replace all self-locking nuts and bolts	

<p>⚠ Danger!</p> <p>1</p> <p>Ⓢ</p>	<p>Risk of explosion from explosive gas. Risk of poisoning and caustic burns from swallowing battery electrolyte. Risk of injury from caustic burns to eyes and skin from battery electrolyte or from handling damaged lead acid batteries.</p> <p>Disconnect battery</p> <p>Notes on battery</p>	<p>No fire, sparks, naked flames or smoking. Wear acid-protective gloves, clothing and eye protection. Pour battery electrolyte only into suitable and appropriately marked containers.</p> <p>All models</p>	<p>Page 22</p> <p>Page 24</p>
<p>2</p>	<p>Separate engine wiring harness at plug connection of cab-chassis</p>		<p>Page 21</p>
<p>3</p>	<p>Remove radiator</p>		<p>AR20.20-W-3865F</p>
<p>4</p>	<p>Remove noise encapsulation panels</p>		
<p>5</p>	<p>Remove hydraulic pump or propeller shaft on engine power take-off</p>	<p>Only on rear engine power take-off.</p>	
<p>6</p>	<p>Remove trim panel above transmission</p>		
<p>7.1</p>	<p>Detach hydraulic lines from engine and transmission as well as hydraulic gear and gate shift cylinders at transmission</p>	<p>Models 950.5/6, 952.5/6, 953.6, 954.5, 970-976 with code (GS3) gearshift "hydraulic"</p> <p>i Do not disconnect hydraulic lines. Lay gear and gate shift cylinders to one side with lines connected.</p> <p>Nm Gear hydraulic cylinder to shift shaft</p> <p>Nm Bearing bracket to transmission housing</p> <p>Nm Gate hydraulic cylinder to transmission housing</p> <p>Nm Gate hydraulic cylinder to shift shaft</p> <p>Nm Gear hydraulic cylinder to transmission housing</p> <p>Nm Compressed-air line to control valve/gearshift cylinder</p>	<p>Page 38</p> <p>BA26.60-N-1009-01D</p> <p>BA26.60-N-1010-01D</p> <p>BA26.60-N-1011-01D</p> <p>BA26.60-N-1012-01D</p> <p>BA26.60-N-1024-01D</p> <p>BA26.60-N-1005-01F</p>
<p>7.2</p>	<p>Detach shift rod from deflection pulley retainer</p>	<p>i Model 375</p>	
<p>8</p>	<p>Remove air intake hose (14) between air intake line and turbocharger</p>		
<p>9</p>	<p>Detach crankcase ventilation hose (13) at crankcase ventilation line</p>		
<p>10</p>	<p>Remove exhaust pipe (4) at engine brake flap connection and at rear lifting eye</p>	<p>i Installation: Check clamp for wear, replace if necessary.</p>	
<p>11</p>	<p>Disconnect wiring harness (3) at bracket (1) in right frame longitudinal</p>		
<p>12</p>	<p>Disconnect compressed air line (15) of engine brake</p>		
<p>13</p>	<p>Separate plug connector (18) at transmission and take off fixture</p>		
<p>14</p>	<p>Separate starter cables (16) at starter</p>		
<p>15</p>	<p>Slacken poly V-belt and take off</p>	<p>i Only on models fitted with air conditioning.</p>	<p>AR13.22-W-1202A</p>
<p>16</p>	<p>Disconnect refrigerant compressor (11) together with bracket at engine</p>	<p>i Do not separate refrigerant lines.</p>	

			BA01.40-N-1005-01C
⚠ Danger!	Risk of explosion from ignition, risk of poisoning from inhaling and swallowing fuel as well as risk of injury from skin and eye contact with fuel.	No fire, sparks, naked flames or smoking. Pour fuels only into suitable and appropriately marked containers. Wear protective clothing when handling fuel.	Page 30
17	Open cap at fuel tank		
18	Separate fuel lines (9) at fuel filter	 Collect fuel which flows out. Mark fuel lines and tie up.	
19	Remove oil filler line (12)	 Seal opening at oil filler hose	
⚠ Danger!	Risk of injury to skin or eyes from hydraulic fluid spraying out under pressure. Risk of poisoning from swallowing hydraulic fluid.	Render the hydraulic system pressureless before commencing work on system. Wear protective clothing and eye protection.	Page 31
20	Separate both hoses at hydraulic oil lines (10) of steering system	 Collect hydraulic oil which flows out	
21	Release and separate plug connector (7) of cable harness at MR/PLD control module	 Tie up plug connector on frame so that it is not damaged when lifting out engine.	
22	Release and separate plug connector (8) of engine cable harness at MR/PLD control module	 Do not damage plug connector when lifting out engine.	
23	Disconnect compressed air line (5) at compressor and at brackets of transmission and inspect for carbon deposits	 Counterhold connection at compressor.  If carbon deposits are present, the compressed-air line between compressor and compressed-air drier and the four-circuit protection valve must additionally be inspected.	
24	Detach transmission oil lines (17) at engine	 Collect transmission oil which flows out	
25	Remove clutch booster (6) at transmission and secure to frame	 With transmission 715.5 only Do not separate hydraulic line. Separate electric cable and compressed air line. Grease plunger head.	BR00.45-Z-1031-06A
26	Unscrew bolts at both engine mounts (2)		
27	Attach engine to removal device		Page 40 WH58.30-Z-1001-07A
28	Attach transmission or support		
29	Unscrew bolts at transmission housing		BA26.10-N-1001-01C
30	Remove engine with removal fixture		Page 40 WH58.30-Z-1001-07A BR00.45-Z-1031-06A
31	Inspect engine mounts (2) for wear	 If wear present ↓ Replace engine mounts	
32	Install in the reverse order		
33	Reprogram transponder key (also spare key)	 Only if a reconditioned engine or a new MR/PLD control unit is installed	AR80.57-W-0010A
34	Check engine-oil level via electrical indicator and if necessary correct	Models 950 - 957	AP18.00-W-0101-07A
35	Inspect coolant level and if necessary adjust to correct level		AP20.00-W-2010A

36	 Danger!	Risk of accident from vehicle starting off by itself when engine running. Risk of injury from bruises and burns if you hold your hand into engine when it is started or when it is running.	Secure vehicle to prevent it moving off by itself. Wear closed and close-fitting work clothes. Do not grasp hot or rotating parts.	Page 33 BE18.00-N-1001-01C	
		Start engine	 Do not rev up engine as long as no oil pressure is indicated  The oil pressure gage must indicate oil pressure after about 10 seconds		
	37	Bleed steering			AR46.25-W-3300C
	38	Switch off engine			
	39	Inspect engine, cooling system and steering hydraulics for leaks	 Visual check.		
40	Set time at tachograph				
41	Enter engine number in FDOK "Screen 1111"		 Only if reconditioned engine is installed.		

Test data of engine oil pressure

Number	Designation	Engine 904.9, 906.9	
		BE18.00-N-1001-01C	Engine oil pressure at
		Maximum speed	bar ≥ 2.5

 **Crankcase, timing case cover, end cover**

Number	Designation	Engines 904.9, 906.9	
BA01.40-N-1005-01C	Bolt of refrigerant compressor carrier to crankcase	Nm	55

 **Manual transmission complete**

Number	Designation		Trans- mission	Trans- missions	Trans- missions
			715.060	715.320/ 715.321	715.500/ 510/520/ 540
BA26.10-N-1001-01C	Transmission to flywheel housing	Nm	45	45	50

Nm Shift mechanism

Number	Designation		Transmission 715.060 with code GS3	Transmission 715.320 with code GS3	Transmissions 715.500/510/520/ 540 with code GS3
BA26.60-N-1009-01D	Gear hydraulic cylinder to shift shaft	Nm	60	70	50
BA26.60-N-1010-01D	Bearing bracket to transmission housing	Nm	-	-	80
BA26.60-N-1011-01D	Gate hydraulic cylinder to transmission housing	Nm	25	25	50
BA26.60-N-1012-01D	Gate hydraulic cylinder to shift shaft	Nm	35	-	50
BA26.60-N-1024-01D	Gear hydraulic cylinder to transmission housing	M10 Nm	-	45	-
		M12 Nm	-	80	-
		M14 Nm	140	-	-

Nm Shift mechanism

Number	Designation		Transmissions 715.320/321
BA26.60-N-1005-01F	Compressed-air line to control valve/gearshift cylinder	M10 Nm	20
		M12 Nm	30

Commercially available tools (see Workshop Equipment Manual)

Number	Designation	Make (e. g.)	Order no.
WH58.30-Z-1001-07A	Engine hoist (self-locking)	Bäcker Herderstraße D-42853 Remscheid	3188

Repair products

Number	Designation	Order no.
BR00.45-Z-1031-06A	Olista Longtime 3 E P	001 989 36 51 10

AR26.60-W-7000-01A	Detaching, attaching shift cylinder with hydraulic line	Transmission 715.060/320/5	
--------------------	---	----------------------------	--

Modification notes

10.4.00	Figure modified from 57 Nm to 60 Nm	Figure in BA26.60-N-1009-01D for transmission 715.060 with code GS3 modified	BA26.60-N-1009-01D
---------	-------------------------------------	--	--------------------

Nm Shift mechanism

Number	Designation		Transmission 715.060 with code GS3	Transmission 715.320 with code GS3	Transmission 715.500/510/520/ 540 with code GS3
BA26.60-N-1009-01D	Gear hydraulic cylinder to shift shaft	Nm	60	70	50
BA26.60-N-1010-01D	Bearing bracket to transmission housing	Nm	-	-	80
BA26.60-N-1011-01D	Gate hydraulic cylinder to transmission housing	Nm	25	25	50
BA26.60-N-1012-01D	Gate hydraulic cylinder to shift shaft	Nm	35	-	50

Nm Shift mechanism

Number	Designation			Transmission 715.060 with code GS3	Transmission 715.320 with code GS3	Transmission 715.500/510/520/ 540 with code GS3
BA26.60-N-1024-01D	Gear hydraulic cylinder to transmission housing	M10	Nm	-	45	-
		M12	Nm	-	80	-
		M14	Nm	140	-	-

Nm Shift mechanism

Number	Designation			Transmission 715.320/321
BA26.60-N-1005-01F	Compressed air line to control valve/gear shift cylinder	M10	Nm	20
		M12	Nm	30

- 1 Detach both securing clamps (2) at the hydraulic lines (1).
- 2 Detach mounting plate (4) for the hydraulic lines (1) at engine; unscrew bolts (3) for this step.

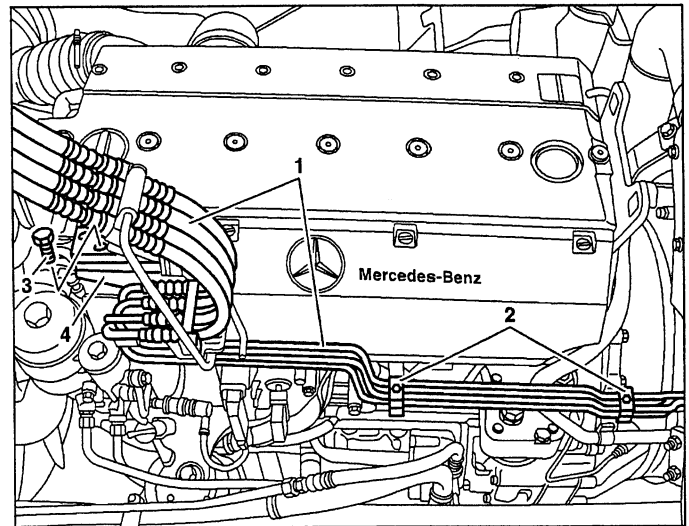

W26.60-1005-11

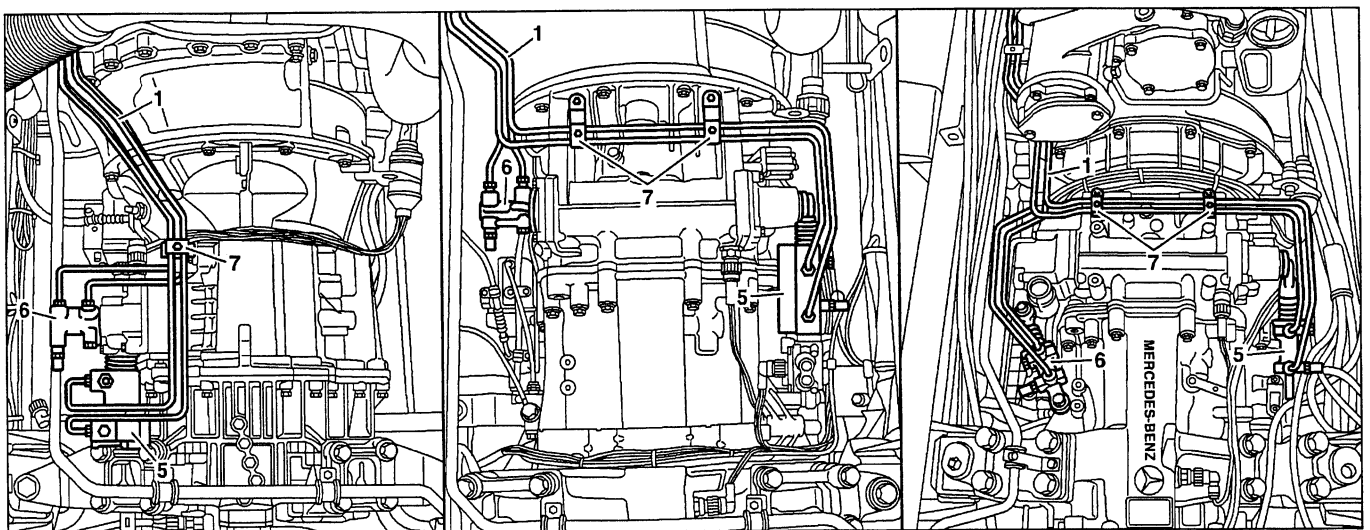

W26.60-1006-08

Hydraulic lines to transmission
Transmission 715.060

Transmission 715.320

Transmission 715.5

3 Detach line attachment (7) together with hydraulic lines (1) at transmission.
i Do not open the securing clamp.

4 Detach hydraulic gate shift cylinder (6) with connected hydraulic lines (1) at transmission.
i Transmission 715.320: push shift cylinder forward and lift out to the rear.

5 Detach hydraulic gate shift cylinder (5) with connected hydraulic lines (1) at transmission.
i Transmission 715.320: additionally detach compressed air line and electrical plug connection at shift cylinder. Transmission 715.510: detach shift cylinder together with bearing bracket.

6 Reinstall in opposite order.
 ⚙️ Replace self-locking nuts.

AR01.10-W-2400-01F	Removing and installing engine with removal fixture		
--------------------	---	--	--

Commercially available tools (see Workshop Equipment Manual)

Number	Designation	Make (e. g.)	Order no.
WH58.30-Z-1001-07A	Engine hoist (self-locking)	Bäcker Herderstraße D-42853 Remscheid	3188

Repair products

Number	Designation	Order no.
BR00.45-Z-1031-06A	Olista Longtime 3 E P	001 989 36 51 10

- 1 Attach engine hoist (2) to the lifting eyes (1 and 4).
- 2 Attach chain tackle (3) at the lifting eye (4) and tension chains at the engine hoist (2) and at the chain tackle. Secure engine to prevent it tilting.
- 3 Push engine sufficiently far away from transmission until the transmission shaft is pulled out of the clutch plate.
- 4 Lift engine up and out.

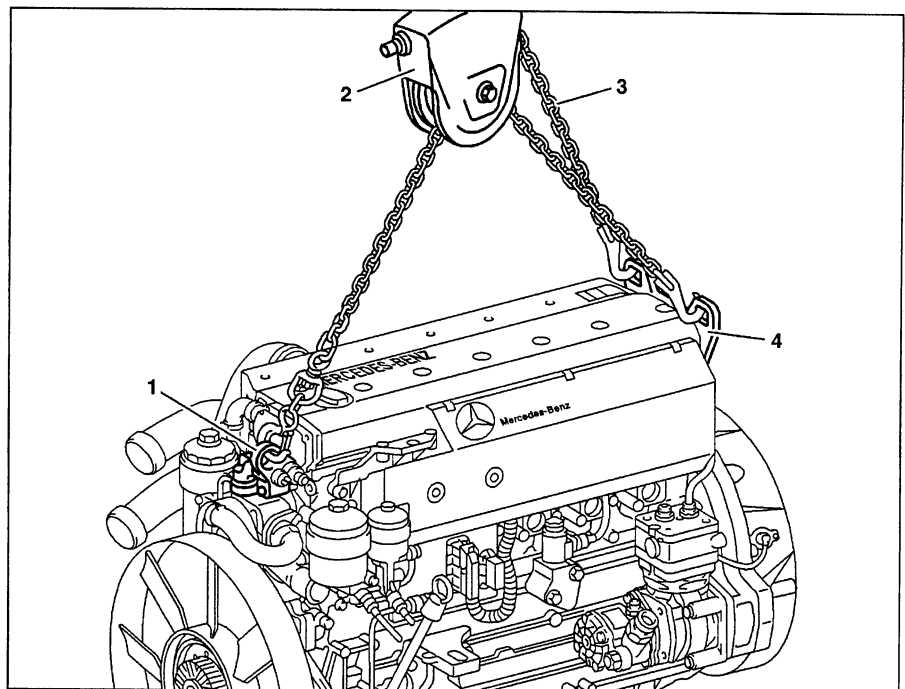

W01.10-1001-06

i Steps 5, 6 and 7 only for transmission 715.5

5 Before installing the engine, lightly grease the transmission shaft and the sliding sleeve in the release (5) with Olista Longtime 3 E P.

6 Rotate release (5) until the tensioning pin (5.1) is positioned horizontally.

7 Position release lever in the correct installation position relative to release (5).

8 Lift engine into the frame and align relative to transmission.

i Do not damage cables, plug connectors and attached parts.

9 Attach engine to transmission.

i Ensure that the internal splines of the clutch plate are aligned with the splines of the transmission shaft; rotate starter ring gear, if necessary.

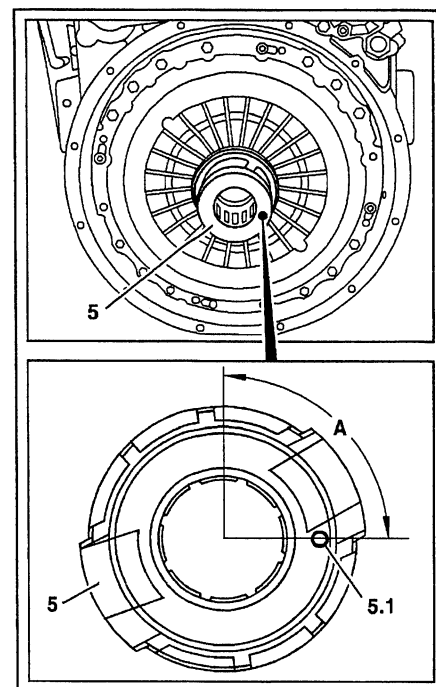

W01.10-1005-03

ENGINES 904.905/906/907/921

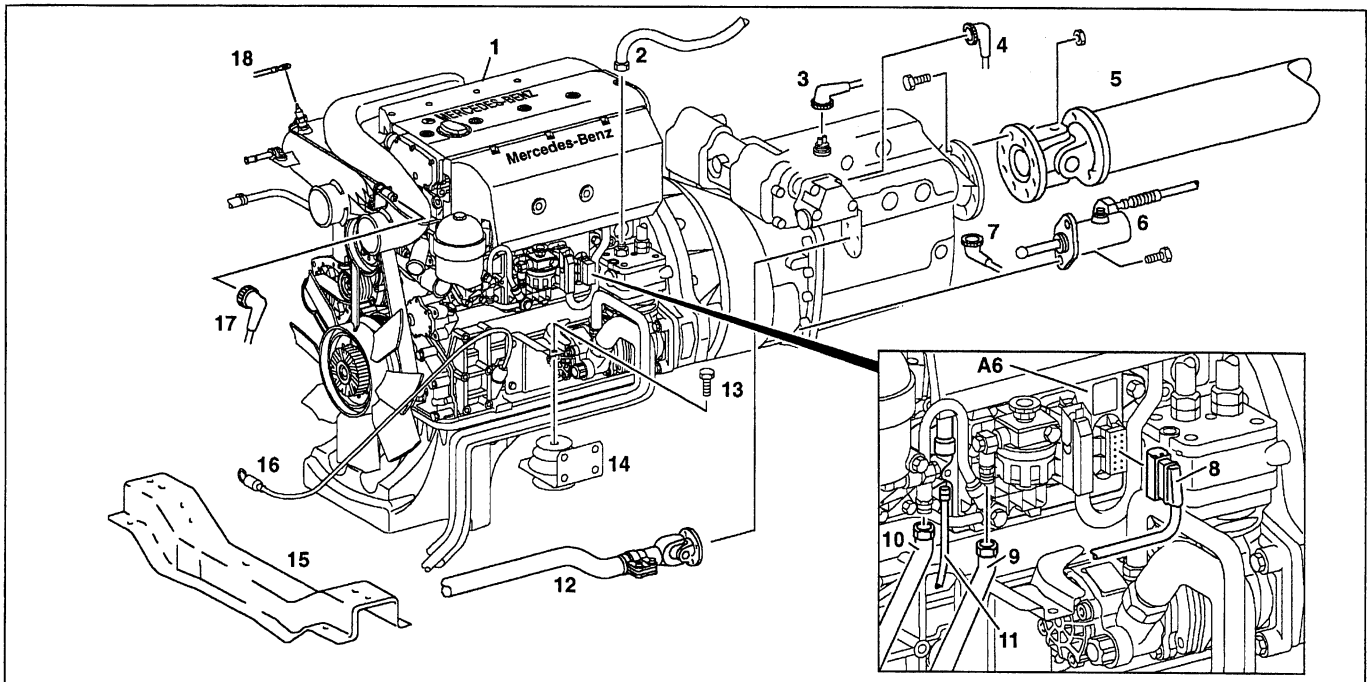

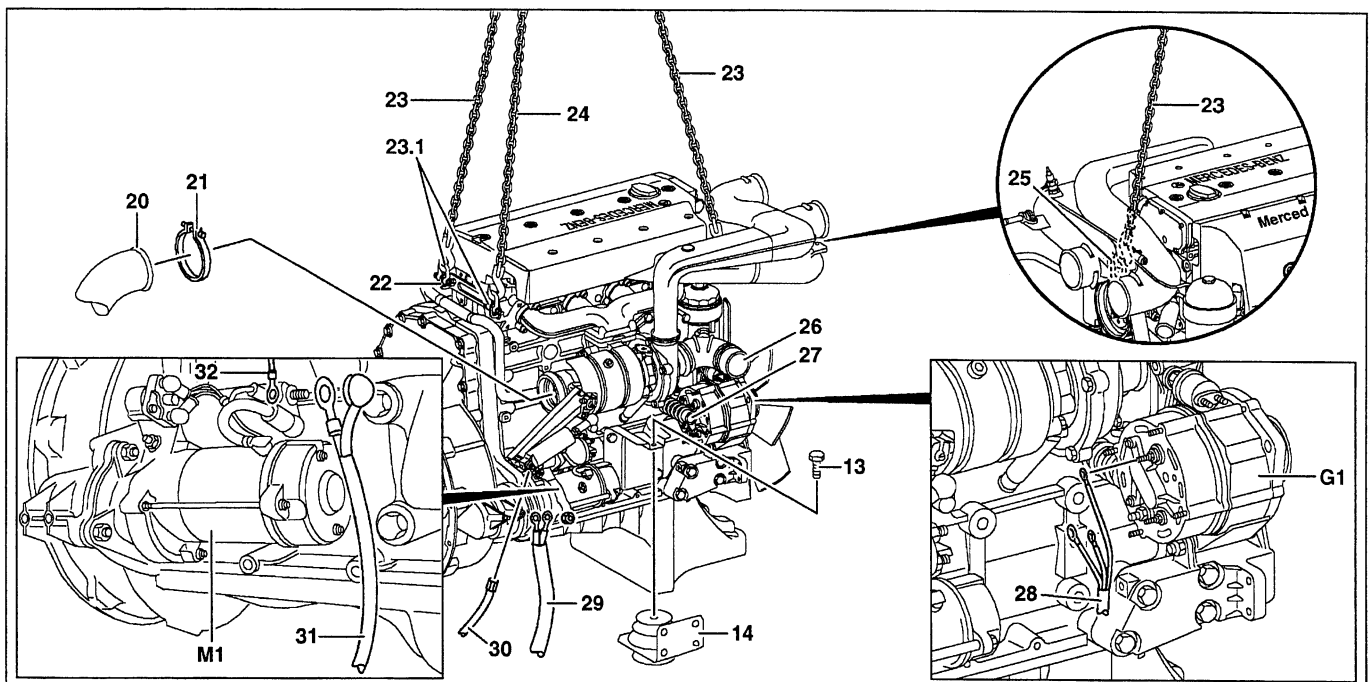

W01.10-0001-09

- | | | | |
|----|---|----|---|
| 2 | Compressed air line (compressor) | 12 | Shift linkage |
| 3 | Plug connector (transmission) | 13 | Bolt |
| 4 | Plug connector (transmission) | 14 | Engine mounting |
| 5 | Propeller shaft | 15 | Frame crossmember |
| 6 | Clutch slave cylinder | 16 | Oil dipstick guide tube |
| 7 | Connector (speedo drive) | 17 | Engine wiring harness (solenoid valve) |
| 8 | Connector (control module) | 18 | Engine wiring harness (flame glow plug) |
| 9 | Fuel line (manual fuel feed pump) | | |
| 10 | Fuel line (fuel filter) | A6 | PLD control module |
| 11 | Compressed air line (constant throttle) | | |



W01.10-0016-09

- 13 Bolt
- 14 Engine mount
- 20 Exhaust pipe
- 21 Clamp
- 22 Rear lifting eyes
- 23  Engine hoist
- 23.1  Shackle
- 24  Chain tackle
- 25 Front lifting eye (coolant pump)
- 26 Air intake hose (turbocharger)

- 27 Air intake hose (compressor)
- 28 Wiring harness (generator)
- 29 Ground cable
- 30 Compressed air line (exhaust brake cylinder)
- 31 Starter cable
- 32 Electric control cable (starter)

- M1 Starter
- G1 Generator

- 5 Propeller shaft
- 7 Plug connection (speedo drive)
- 33 Bolt
- 34 Nut
- 35 Rear transmission mounting

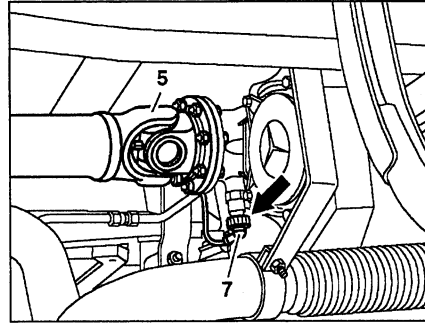



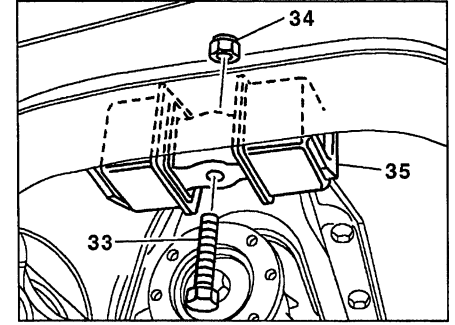



W01.10-0003-01





















W01.10-0004-01

Modification notes

6.7.98	Enter engine number in FDOK after replacing engine	Step 36 added	
--------	--	---------------	--

		Removing, installing	
	Danger!	<p>Risk of explosion from explosive gas. Risk of poisoning and caustic burns from swallowing battery electrolyte. Risk of injury from caustic burns to eyes and skin from battery electrolyte or from handling damaged lead acid batteries.</p>	Page 22
1		<p>Disconnect battery</p> <p>Notes on battery</p>	Page 24
2		<p>Risk of injury from hand being jammed and bruised when tilting cab</p> <p>Tilt cab</p> <p>Notes on tilting cab</p>	Page 24
3		Tilt cab into repair position	Page 25
4		Remove rear cab mounting	
5		Remove noise encapsulation panels	AR60.80-W-0010A
6		Remove radiator and charge air cooler	AR20.20-W-3865A
7		Tie up dipstick guide tube (16) at engine	
8		Detach exhaust pipe (20) at engine brake flap connection	 Installation: Clean sealing surfaces
9		Detach compressed air line (30) at engine brake cylinder	 Engines fitted with engine brake
10		Detach air intake hoses (26, 27) for turbocharger and compressor at air cleaner	
11		Separate electric cables (17, 18) at flame glow plug and at solenoid valve	 Engines fitted with flame starting system

12	Separate starter cable (31) and control cable (32) at starter (M1)		
13	Separate wiring harness (28) at generator (G1)	 Pay attention to color coding	
14	Separate ground cable (29) at timing case		
15	Detach shift linkage (12) at transmission shift mechanism		
16	Remove clutch slave cylinder (6)	 Installation: Grease thrust pin.	
17	Unbolt compressed air line (2) at compressor and inspect for carbon deposits	 If carbon deposits are present, the compressed air line between compressor and compressed air drier with integrated pressure regulator and the four-circuit protection valve must additionally be inspected. Replace parts with carbon deposits.  Installation: Inspect compressed air line for leaks.	
 Danger!	Risk of explosion from ignition, risk of poisoning from inhaling and swallowing fuel, as well as risk of injury from skin and eye contact with fuel.	No fire, sparks, naked flames or smoking. Pour fuels only into suitable and appropriately marked containers. Wear protective clothing when handling fuel.	Page 30
18	Separate fuel lines (9, 10)	 At fuel priming pump and at fuel filter. Collect fuel which flows out.	
19	Separate pressure line (11) of constant throttle	 Engines fitted with constant throttle	
20	Release and separate connector (8) at PLD control module (A6)		
 Danger!	Risk of injury to skin or eyes from hydraulic fluid spraying out under pressure. Risk of poisoning from swallowing hydraulic fluid.	Render the hydraulic system pressureless before commencing work on system. Wear protective clothing and eye protection.	Page 31
21	Separate both hoses at steering lines	 Collect hydraulic oil which flows out  Installation: Top up hydraulic fluid and bleed steering.	WH4611
22	Remove frame crossmember (15)	 Below radiator and engine	
23	Attach engine hoist (23) at the front to lifting eye (25) of coolant pump and guide up	 Engine hoist	WH58.30-Z-1001-07A
24	Attach engine hoist (23) at rear left to lifting eye (22)	 Insert shackle (23.1) as intermediate piece so that engine hoist does not run across the cylinder cover.  Shackle	WH58.30-Z-1002-07A
25	Attach chain tackle (24) at rear right to lifting eye (22) and tension chains at engine hoist and at chain tackle	 Insert shackle (23.1) as intermediate piece so that engine hoist does not run across the charge air manifold. Secure engine to prevent it tilting.  Shackle	WH58.30-Z-1002-07A
26	Separate connectors (3, 4, 7) at transmission	 Installation: Replace anti-tamper seal (arrow) at connector (7).	
27	Detach propeller shaft (5) at transmission and attach to frame		BA41.10-N-1002-01F

28	Unscrew bolt (33) at rear transmission mounting (35)	Installation: Replace nut (34).	
29	Unscrew bolts (13) on both sides at engine mountings (14)	Inspect engine mountings for wear, replace engine mountings if necessary.	
30	Lift out engine together with transmission	Max. 30° tilt of engine with transmission when lifting out or inserting.	
31	Detach transmission from engine	Transmission 710.620 Transmission 715.050	BA26.10-N-1003-01B BA26.10-N-1006-01C
32	Install in the reverse order		
33	Check engine oil level with dipstick		WH0101.40
34	Start engine and observe oil pressure gage at idle speed	Start engine with starter for max. 90 seconds. Wait about 2 minutes before repeating start operation. Motor nicht hochdrehen solange noch kein Öldruck angezeigt wird. The oil pressure gage must indicate oil pressure after about 10 seconds.	BE18.00-N-1001-01C
35	Switch off engine and inspect for leaks		
36	Enter engine number in FDOC "Screen 1111"	Only if reconditioned engine is installed	

Test data of engine oil pressure

Number	Designation	Engines 904.9, 906.9
BE18.00-N-1001-01C	Engine oil pressure at	Idle speed bar ≥ 0.5
		Maximum speed bar ≥ 2.5

Manual transmission complete

Number	Designation	Transmission
BA26.10-N-1003-01B	Transmission to engine	Nm 51

Manual transmission complete

Number	Designation	Transmission
BA26.10-N-1006-01C	Transmission to engine	Nm 51

Propeller shaft

Number	Designation	Models 673, 674, 675, 676, 677, 679
BA41.10-N-1002-01F	Bolt/nut of propeller shaft to transmission/rear axle (flange connection)	M10 Nm 60
		M12 Nm 100



Commercially available tools (see Workshop Equipment Manual)

Number	Designation	Make (e. g.)	Order no.
WH58.30-Z-1001-07A	Engine hoist (self-locking)	Bäcker Herderstraße D-42853 Remscheid	3188
WH58.30-Z-1002-07A	Shackle		C1 DIN 82101

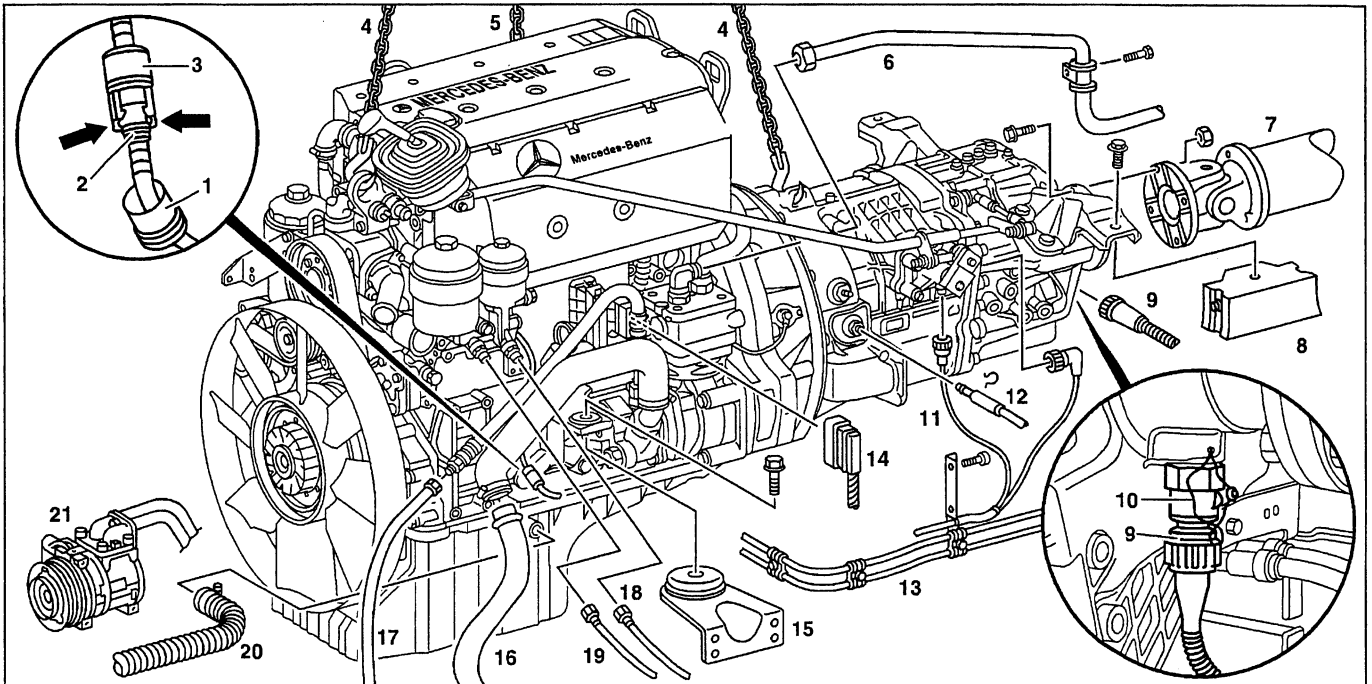
ENGINES 904.909 /910 /911 /915 /916 /917 /922, 906.910 /911 /915 /916



W01.10-0013-09

- | | | | |
|----|--|----|----------------------------------|
| 1 | Cap (on engines 904.909-911/915-917/922) | 11 | Plug connector (transmission) |
| 2 | Coupling, compressed-air line
(on engines 904.909- 911/915-917/922) | 12 | Clutch line |
| 3 | Plug, compressed-air line
(on engines 904.909-911/915-917/922) | 13 | Cable harness, cable and bracket |
| 4 |  Engine hoist | 14 | Connector (control module) |
| 5 |  Chain tackle | 15 | Engine mount |
| 6 | Compressed air line (compressor) | 16 | Steering line (return flow) |
| 7 | Propeller shaft | 17 | Steering line (pressure) |
| 8 | Transmission bearing | 18 | Fuel line (feed) |
| 9 | Connector (speedo drive) | 19 | Fuel line (return flow) |
| 10 | Lead seal | 20 | Oil filler pipe |
| | | 21 | Refrigerant compressor |

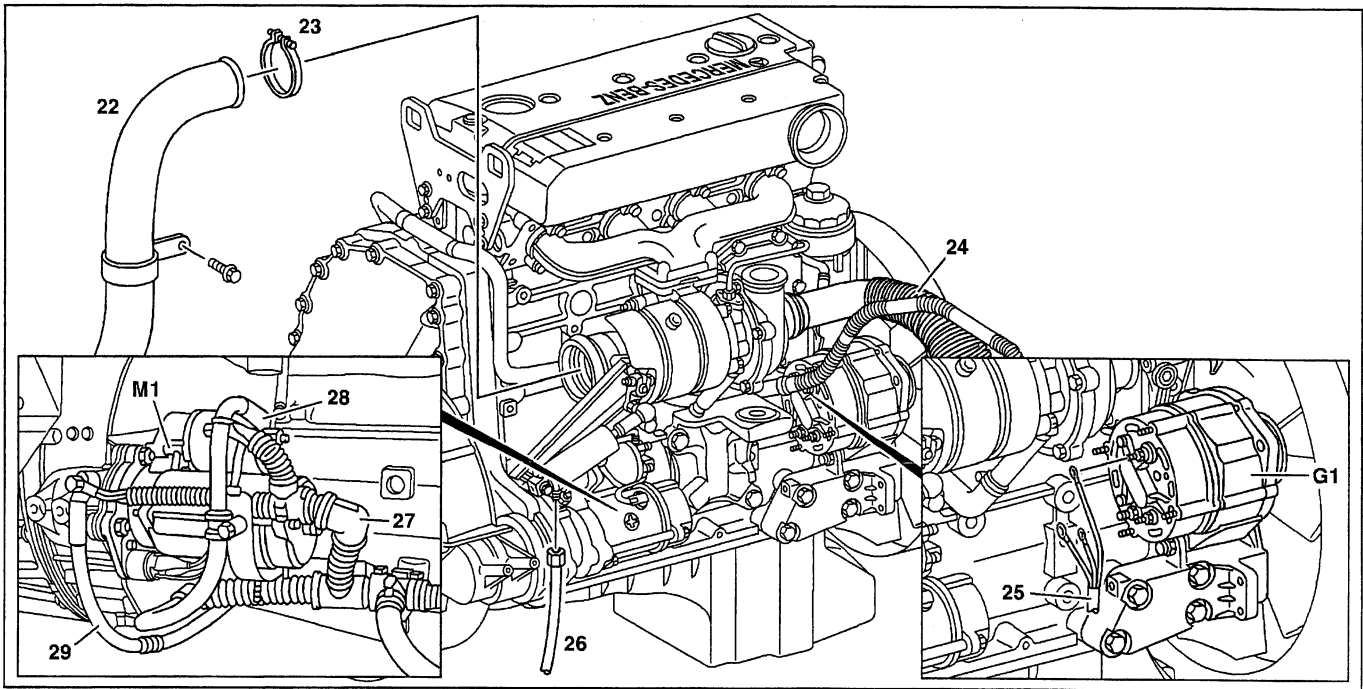

W01.10-0012-09

- 22 Exhaust pipe
- 23 Clamp
- 24 Air intake house
- 25 Electric cable (generator)
- 26 Compressed air line (engine brake cylinder)
- 27 Electric cable harness
- 28 Starter cable
- 29 Ground cable
- G1 Generator
- M1 Starter

Modification notes

10.12.99	Set time at tachograph	Step 34 added
----------	------------------------	---------------

	Removing, installing		
☒ ☒			
ⓘ Installation	Replace all self-locking nuts and bolts		
⚠ Danger!	Risk of explosion from explosive gas. Risk of poisoning and caustic burns from swallowing battery electrolyte. Risk of injury from caustic burns to eyes and skin from battery electrolyte or from handling damaged lead acid batteries.	No fire, sparks, naked flames or smoking. Wear acid-protective gloves, clothing and eye protection. Pour battery electrolyte only into suitable and appropriately marked containers.	Page 22
1	Disconnect battery		
ⓘ	Notes on battery	All models	Page 24
⚠ Danger!	Risk of injury from hand being jammed and bruised when tilting cab	No person must be within the tilting range of the cab when the cab is tilted. Always tilt cab as far as the end position and secure with safety prop.	Page 24
2	Tilt cab into repair position		
ⓘ	Notes on tilting cab	Models 375, 970-976	Page 25
3	Remove noise encapsulation panels		
4	Remove charge air pipe from charge air cooler to charge air manifold		AR09.41-W-1311D
5	Remove charge air pipe from turbocharger to charge air cooler		AR09.41-W-1311C

6	Remove fan shroud		AR20.40-W-6800A
7	Detach oil filler line (20) at oil pan and secure on frame	Plug opening on sump.	
8	Detach exhaust pipe (22) at engine brake flap connection and at transmission	Secure exhaust pipe on frame.	
9	Detach compressed air line (26) at engine brake cylinder		
10	Detach air intake hose (24) at air cleaner housing		
11	Detach cable at flame glow plug and at solenoid valve		
12	Disconnect electric cable (28) at starter (M1) and wiring harness (27) at bracket		
13	Detach electric cable (25) at generator (G1) and at bracket	Pay attention to color coding	
14	Disconnect ground cable (29) and wiring harness at timing case	On side and at bottom	
15	Unbolt compressed air line (6) at compressor and inspect for carbon deposits	If carbon deposits are present, the compressed-air line between compressor and compressed-air drier and the four-circuit protection valve must additionally be inspected. Replace parts with carbon deposits. Installation: Inspect compressed air line for leaks.	
Danger!	Risk of explosion from ignition, risk of poisoning from inhaling and swallowing fuel as well as risk of injury from skin and eye contact with fuel.	No fire, sparks, naked flames or smoking. Pour fuels only into suitable and appropriately marked containers. Wear protective clothing when handling fuel.	Page 30
16	Separate fuel lines (18, 19) at fuel filter	Mark fuel lines and collect fuel which flows out.	
17	Slacken poly V-belt and take off	Only on models fitted with air conditioning.	AR13.22-W-1202A
18	Detach refrigerant compressor (21) at engine	Do not separate refrigerant lines.	
19	Separate compressed air lines (2, 3) of constant throttle	Engines 904.909-911/915-917/922 with constant throttle, pull off cap (1), press clamp apart using pliers and pull connector out of socket.	
20	Release and separate connector of cable harness (14) at MR/PLD control unit		
Danger!	Risk of injury to skin or eyes from hydraulic fluid spraying out under pressure. Risk of poisoning from swallowing hydraulic fluid.	Render the hydraulic system pressureless before commencing work on system. Wear protective clothing and eye protection.	Page 31
21	Separate both hoses at the steering lines (16, 17)	Collect escaping hydraulic fluid.	
22	Remove locking element and pull out clutch line (12) at transmission	Collect escaping brake fluid. Installation: Bleed clutch actuation.	AR25.20-W-0070C
	Notes on brake fluid	All models	Page 51

23	Separate connectors (9, 11) at transmission	Installation: Replace anti-tamper seal (10) at connector (9).	
24	Detach propeller shaft (7) at transmission and attach to frame		BA41.10-N-1002-01F
25	Remove bolts of transmission bracket to transmission mounting (8)	Inspect transmission mounting for wear, replace if necessary.	
26	Remove bolts at both engine mounts (15)	Inspect engine mounts for wear, replace if necessary.	
27	Remove engine with removal fixture		Page 51 WH58.30-Z-1001-07A
28	Detach transmission from engine	Transmissions 710.621/622/623/ 626/627 Transmissions 715.050/060/320	BA26.10-N-1006-01B BA26.10-N-1001-01C
29	Install in the reverse order		
30	Reprogram transponder key (also spare key)	Only if a reconditioned engine or a new MR/PLD control unit is installed.	AR80.57-W-0010A
31	Check engine-oil level via electrical indicator and if necessary correct	See operating instructions part 3.	
32	Inspect coolant level and if necessary adjust to correct level		AP20.00-W-2010A
Danger!	Risk of accident from vehicle starting off by itself when engine running. Risk of injury from bruises and burns if you hold your hand into engine when it is started or when it is running.	Secure vehicle to prevent it moving off by itself. Wear closed and close-fitting work clothes. Do not grasp hot or rotating parts.	Page 33
33	Start engine	Do not rev up engine as long as no oil pressure is indicated The oil pressure gage must indicate oil pressure after about 10 seconds	BE18.00-N-1001-01C
34	Switch off engine		
35	Top up hydraulic fluid of steering and bleed steering.		AP46.00-W-4611A
36	Inspect engine, cooling system and steering hydraulics for leaks	Visual check.	
37	Set time at tachograph		
38	Enter engine number in FDOK "Screen 1111"	Only if reconditioned engine is installed.	

Test data of engine oil pressure

Number	Designation	Engines 904.9, 906.9	
BE18.00-N-1001-01C	Engine oil pressure at	Idle speed	bar ≥ 0.5
		Maximum speed	bar ≥ 2.5

Nm Manual transmission complete

Number	Designation	Transmissions 710.621/622/ 623/626/627/68
BA26.10-N-1006-01B	Transmission to flywheel housing	Nm 45

Nm Manual transmission complete

Number	Designation	Trans- mission 715.050	Trans- mission 715.060	Trans- missions 715.320/ 715.321
BA26.10-N-1001-01C	Transmission to flywheel housing	Nm 45	45	45

Nm Propeller shaft

Number	Designation	Models 970, 972, 974, 975, 976
BA41.10-N-1002-01F	Bolt/nut of propeller shaft to transmission/rear axle (flange connection)	M10 Nm 60
		M12 Nm 100

Commercially available tools (see Workshop Equipment Manual)

Number	Designation	Make (e. g.)	Order no.
WH58.30-Z-1001-07A	Engine hoist (self-locking)	Bäcker Herderstraße D-42853 Remscheid	3188

AH42.50-P-0001-01A	Notes on brake fluid	All models	
--------------------	----------------------	------------	---

- Do not allow brake fluid to come into contact with vehicle paintwork, as it contains ingredients that act as solvents on the paint. If, in spite of taking appropriate care, brake fluid does come into contact with the paintwork, the affected surface must immediately be rinsed with copious amounts of water (do not rub off brake fluid).
- Brake fluid is highly hygroscopic, i.e. it absorbs humidity which reduces its boiling point. Brake fluid must therefore only be kept in closed, well-sealed storage containers (original container).
- Used brake fluid must not be re-used.
- Brake fluid is colorless to yellow colored and is therefore easily confused with mineral oil products. Brake fluid must therefore always be taken only from original containers and stored separately from mineral oil and other fluids.
- For disposal information for the Federal Republic of Germany, see:
"Umweltschutz-Handbuch für Kfz-Reparaturbetriebe"
Publisher: Verband der Automobilindustrie e.V. (VDA)
60625 Frankfurt am Main, Westendstraße 61

AR01.10-W-2400-01A	Removing and installing engine with removal fixture	Engine with transmission	
--------------------	--	--------------------------	--

Commercially available tools (see Workshop Equipment Manual)

Number	Designation	Make (e. g.)	Order no.
WH58.30-Z-1001-07A	Engine hoist (self-locking)	Bäcker Herderstraße D-42853 Remscheid	3188

- 1 Attach engine hoist (1) to the lifting eyes (2 and 3).
- 2 Attach chain block (4) at the rear right of the exhaust manifold and tension chains at engine hoist (1) and at chain block. Secure engine to prevent it tilting.
- 3 Lift out engine together with transmission.
- 4 When installing, align engine and transmission at the engine and transmission mounts.

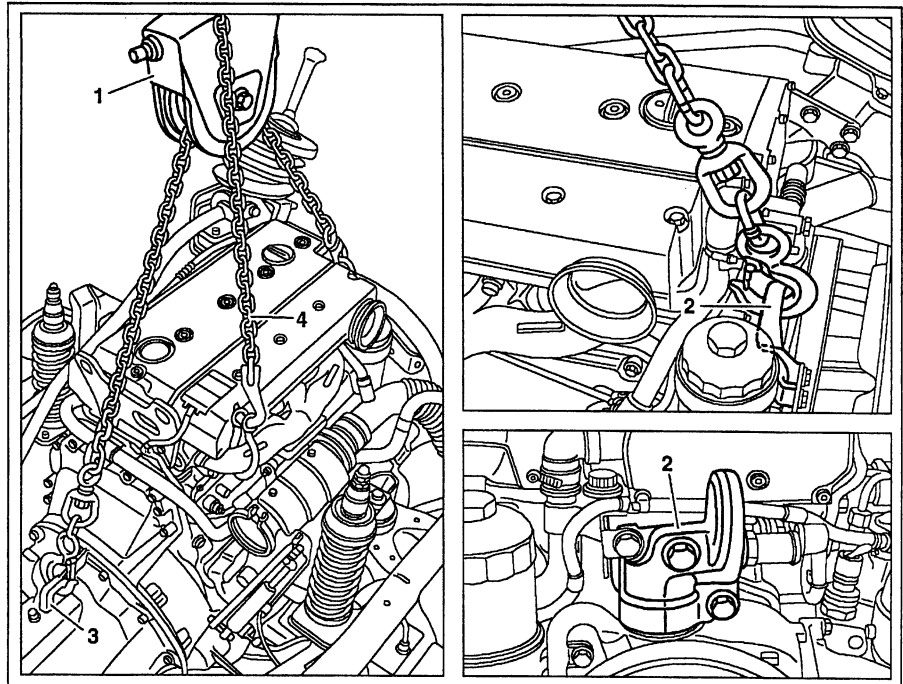

W01.10-0010-06

ENGINE 541, 542, 904, 906

	Removing		
		If oil consumption is high or if engine has failed, it is often unclear whether dust damage or normal wear exists.	
1	Remove pistons	Engine 904, 906 Engine 541, 542	AR03.10-W-7021A AR03.10-W-7021B
	Inspecting		
2	Inspect intake passage between air cleaner and engine for dust deposits	Severe dust deposits in the elbows of the intake pipes and hoses are a clear indication of dust damage. On engines fitted with oil bath air cleaner, a very fine film is permissible.	
3	Inspect pistons and cylinder walls for wear (dust damage)	The stem contact patterns of the pistons and the honing patterns of the cylinders indicate damage caused by increased presence of dust. If wear present, ↓ Install new cylinder liner Engine 904, 906 Replace cylinder liner Engine 541, 542 Replace pistons, engine 904, 906 Replace pistons, engine 541, 542	Page 92 AR01.40-W-9324A AR03.10-W-7021A AR03.10-W-7021B
		Notes for assessing wear to cylinder wall in the case of dust damage	Page 53
		Notes for assessing wear of pistons in the case of dust damage	Page 54

AH01.40-N-0001-01A	Notes for assessing wear of cylinder wall if dust damage present	Engine 904, 906, 541, 542	
--------------------	--	---------------------------	--

Cylinder walls or cylinder liners without dust damage

The honing is more or less clearly recognizable over the entire contact surface. The honing may be partially worn off at the reversal point of the first piston ring.

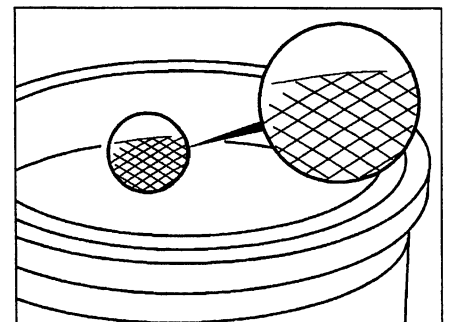

W03.10-0014-01

Cylinder walls or cylinder liners with dust damage

The traces of machining from honing are only still weakly visible or not at all. If wear is at an advanced stage, a wear step can be felt at the reversal point of the first piston ring.



Dust damage is caused by poor seal, splits or chafing of the inlet lines, seals and hoses. When carrying out maintenance and repair work, inspect all the inlet lines, seals and hoses carefully, even at points which are not easily accessible.

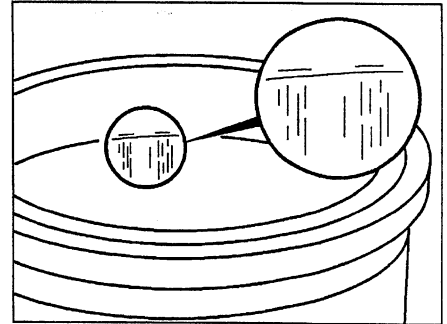

W03.10-0015-01

AH03.10-N-0001-01A	Notes for assessing wear to pistons in the case of dust damage	Engine 541, 542, 904, 906	
--------------------	--	---------------------------	--

Pistons without dust damage

The contact surface of the piston stem is visible over a large area and the machining grooves can still be recognized within this area.



The machining grooves at the circumference are intentional recesses which are filled with oil and contribute to better lubrication.

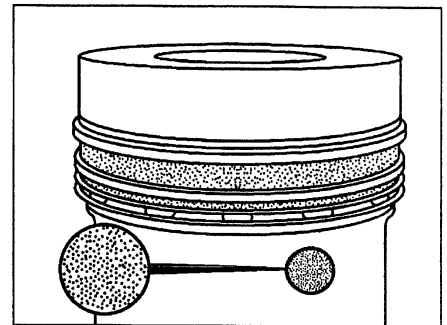

W03.10-0012-01

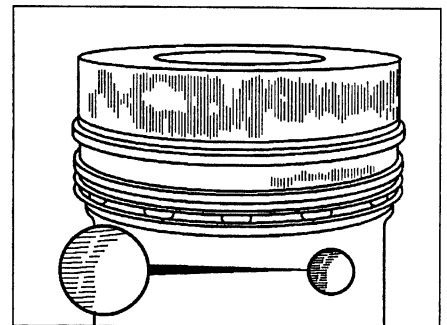

Pistons with dust damage

The contact pattern at the stem has a mat (pumiced) appearance and the machining grooves are completely worn away within the contact surface. In the advanced stage of wear, slight traces of seizure are already present on the stem and the piston rings are sharp-edged.







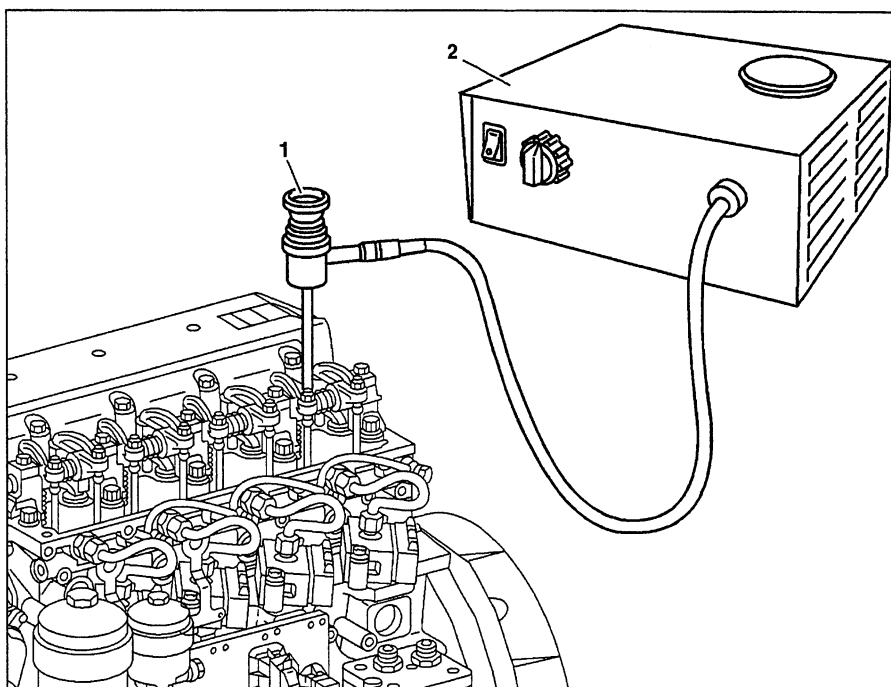

W03.10-0013-01

ENGINE 904.905 /906 /907 /908 /909 /910 /911 /915 /916 /917 /921 /922 /923, 906.910 /911 /915 /916 /919 /920 /921 /922 /923 /925 /926 /927 /928 /939 /940 /941 /942 /943 /951 /952

- 1  Inspection probe
2  Cylinder inspection equipment



W01.00-0018-06

	Removing, installing		
1	Attach cranking device to timing case	  Bolt of end cover to timing case	<p align="right">Page 56</p> 904 589 04 63 00 BA01.60-N-1002-01A
2	Remove nozzle holder combination	Engine 904.905-908/921 up to end no. 040487 Engine 904.905-908/921 as of end no. 040488, 904.909-911/915-917/922/923, 906.910/911/915/916/919-923/925-928/ 939/940/941/942/943/951/952	AR07.03-W-6831A AR07.03-W-6831C
3	Rotate crankshaft with cranking device	Position piston of cylinder to be inspected to BDC	
4	Connect cylinder inspection equipment (2) and insert inspection probe (1) through the hole of the protective sleeve into the cylinder	  Connection of cylinder inspection equipment, see operating instructions of equipment manufacturer	WH58.30-Z-1028-05A
	Inspecting		
5	Inspect cylinder wall and piston crown	 Cylinder wall must not have any scorch streaks and rubbing streaks. Individual slight drawing scores are not critical. Inspect condition of piston crown, if necessary ↓ Remove cylinder head	Page 53

		Engine 904.905-907/909-911/915-917/ 921/922, 906.910/911/915/916/919-923/ 925-928/939/940/941/942/943/951/952 Engine 904.908/923	Page 69 AR01.30-D-5800D
6	Inspect the remaining cylinders in the same way		
N	Install in the reverse order		

Nm Timing case

Number	Designation	Engine 904.9, 906.9
BA01.60-N-1002-01A	End cover of inspection hole to timing case	Nm 25

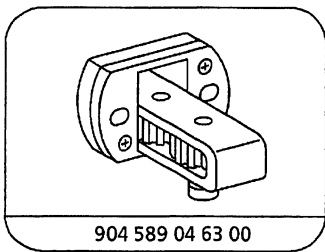

904 589 04 63 00

Cranking device

Commercially available tools (see Workshop Equipment Manual)

Number	Designation	Make (e. g.)	Order no.
WH58.30-Z-1028-05A	Cylinder inspection equipment Motoskop TW (dichroic light) with lens probes 103 26 CW (570 mm) and 103 26 CT (210 mm)	Karl Storz GmbH D-78532 Tuttlingen	

AR03.30-W-1600-03A	Attaching, detaching cranking/blocking device for engine		
--------------------	--	--	--

Nm Timing case

Number	Designation	Engine 904.9, 906.9
BA01.60-N-1002-01A	End cover of inspection hole to timing case	Nm 25

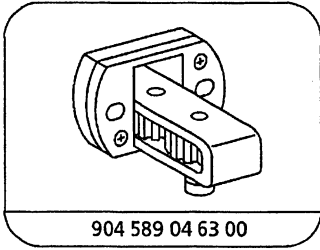



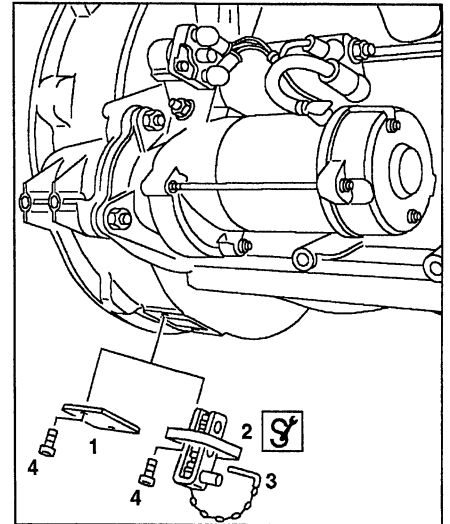

Cranking device

- 1 Remove noise encapsulation below flywheel housing.
- 2 Remove cover (1) at flywheel housing (if fitted).
- 3 Attach cranking and blocking device (2) tight to flywheel housing with bolts (4).
- Cranking and blocking device (2) can be blocked by inserting the pin (3).
- Cranking and blocking device (2) must be removed before starting the engine.



W03.30-0001-02

ENGINE 904.905 /906 /907 /908 /909 /910 /911 /921 /922 /923, 906.910 /911 /920 /921 /922 /923 /940 /941 /942 /943 /951 /952



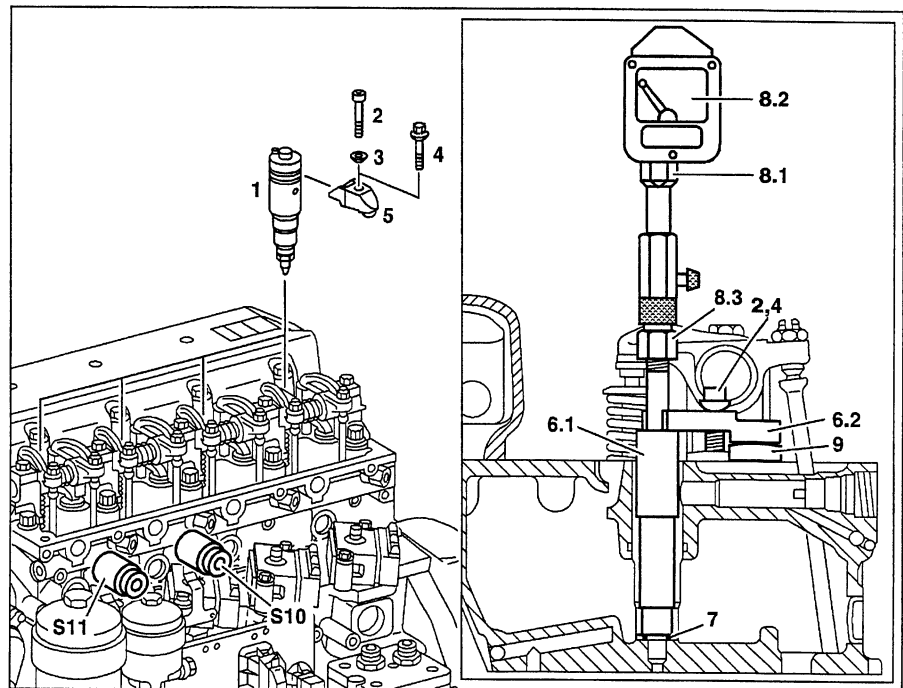

- 1 Nozzle holder combination
 2 Bolt (up to engine end no. 046892)
 3 Spherical washer
 (up to engine end no. 046892)
 4 Bolt with spherical collar
 (as of engine end no. 046893)
 5 Tensioning arm
 6.1  Connection piece
 6.2  Tensioning arm
 7 Seal
 8.1  Compression recorder
 8.2  Diagram chart
 8.3  Intermediate piece
 9 End cover of constant throttle
 S10 Start switch
 S11 Stop switch











W01.00-1006-06

Modification notes

10.11.99	Modified attachment of enlarged special tool, connection piece clamped tight with tensioning arm supplied	Step 5	
----------	---	--------	--

	Removing		
 Danger!	Risk of injury from hand being jammed and bruised when tilting cab	No person must be within the tilting range of the cab when the cab is tilted. Always tilt cab as far as the end position and secure with safety prop.	Page 24
1.1	Tilt cab		
	Notes on tilting cab	Model 375, 673- 679, 950- 954, 957, 970- 976	Page 25
1.2	Take off service cover	Model 668, 670	
2	Set valve clearance	 Perform setting only when engine cold, or thoroughly warmed through. Wait at least 30 minutes after switching off engine. Engine 904.905- 907/921 Engine 904.905- 907/909- 911/915- 917/ 921/922, Engine 906.910/911/915/916/919- 923/ 925- 928/939/940/941/942/943/951/952 Engine 904.908/923	0560.30 AP05.30-W-0560B AP05.30-D-0560A
3	Warm engine up to operating temperature	 Coolant temperature approx. 70 to 95 °C	

4	Remove nozzle holder combinations (1)	Engine 904.905- 908/921 up to end no. 040487 Engine 904.905- 908/921 as of end no. 040488 Engine 904.909- 911/915- 917/922/923 Engine 906.910/911/915/916/919- 923/ 925- 928/939/940/941/942/943/951/952	AR07.03-W-6831A AR07.03-W-6831C
5	Install connection piece (6.1), tensioning arm (6.2) with bolt (2) and spherical washer (3) or with bolt with spherical collar (4)	 Stick seal (7) with grease to the connection piece.  	BA07.15-N-1003-01A 904 589 01 21 00
6	Attach compression recorder (8.1) to the connection piece (6.1)	 Connection of compression recorder, see operating instructions 	001 589 78 21 00 904 589 01 21 00
N	Insert diagram chart (8.2) into the compression recorder (8.1)		001 589 78 21 00
	Inspecting		
 Danger!	Risk of accident from vehicle starting off by itself when engine running. Risk of injury from bruises and burns if you hold your hand into engine when it is started or when it is running.	Secure vehicle to prevent it moving off by itself. Wear closed and close-fitting work clothes. Do not grasp hot or rotating parts.	Page 33
8	Crank engine with the starter by pressing the start switch (S10) and stop switch (S11) at the same time	 at least 8 engine revolutions	
9	Test the remaining cylinders in the same way.		
10	Compare the measurements recorded on the chart (8.2) with the permissible specifications	Compression pressure at starter speed Permissible difference between individual cylinders If variations exist, remove cylinder head ↓ Engine 904.905- 907/909- 911/ 915-917/921/922 Engine 906.910/911/915/916/919- 923/ 925- 928/939/940/941/942/943/951/952 Engine 904.908/923	BE01.00-N-1001-01E BE01.00-N-1002-01E Page 69 AR01.30-D-5800D
11	Take off compression recorder (8.1) and connection piece (6.1) together with seal (7)		
	Installing		
12	Install nozzle holder combinations (1)	Engine 904.905- 908/921 up to end no. 040487 Engine 904.905- 908/921 as of end no. 040488. Engine 904.909- 911/915- 917/922/923 Engine 906.910/911/915/916/919- 923/ 925- 928/939/940/941/942/943/951/952.	AR07.03-W-6831A AR07.03-W-6831C

Test data of compression pressure

Number	Designation	Engine 904.9, 906.9
BE01.00-N-1001-01E	Compression pressure at starter speed	bar ≥ 28
BE01.00-N-1002-01E	Permissible difference between individual cylinders	bar ≥ 4

Nm Diesel injection system with unit pumps (PLD)

Number	Designation	Engine 904.9, 906.9
BA07.15-N-1003-01A	Screw of clamp of nozzle holder combination to cylinder head	Hexagon socket Nm 30
		Twelve-point with spherical collar 35

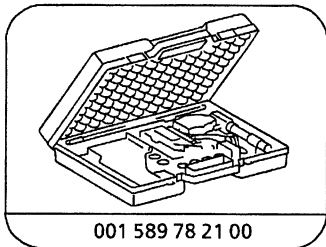

001 589 78 21 00

Compression recorder

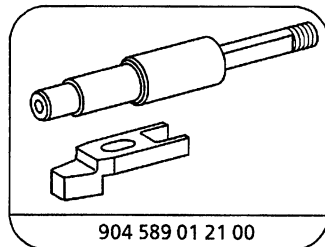

904 589 01 21 00

Connection piece

ENGINE 904.905 /906 /907 /908 /909 /910 /911 /915 /916 /917 /921 /922 /923, 906.910 /911 /915 /916 /919 /920 /921 /922 /923 /925 /926 /927 /928 /939 /940 /941 /942 /943 /951 /952

- 1 Hexagon socket bolt
- 2 Sealing washer
- 3 Gasket
- 4 Crankcase ventilation hose
- 5 Cylinder head cover
- 6 Gasket
- 7 Engine trim panel

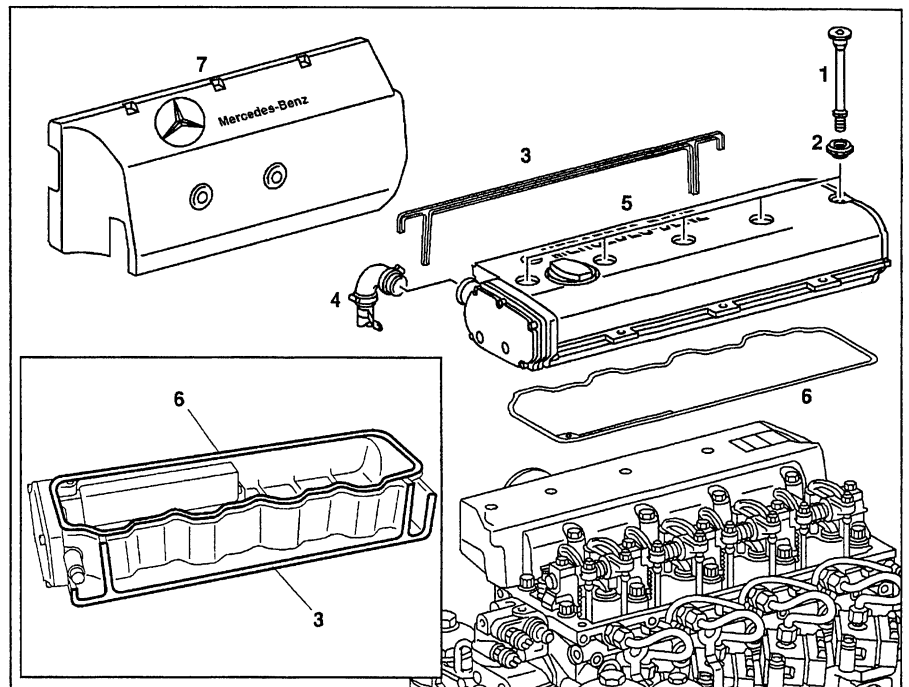



W01.20-0004-06

Engine 906 with code (GS3) "hydraulic" transmission shift

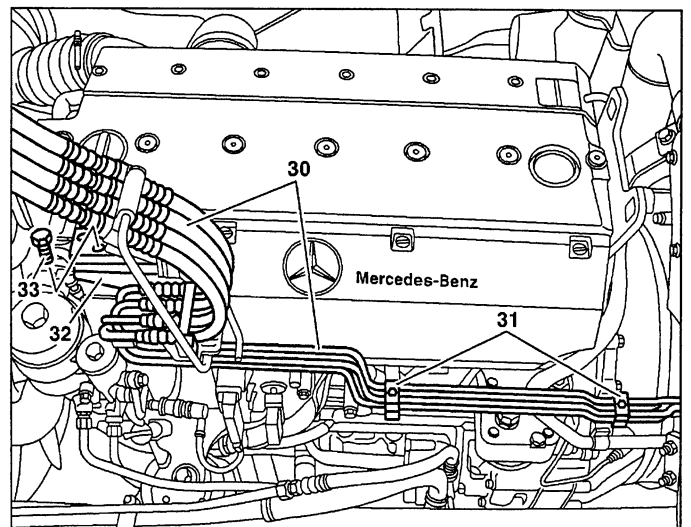
- 30 Hydraulic lines
- 31 Securing clamps
- 32 Securing plate
- 33 Bolt



W26.60-1011-11

	Removing, installing		
 Danger!	Risk of injury from hand being jammed and bruised when tilting cab	No person must be within the tilting range of the cab when the cab is tilted. Always tilt cab as far as the end position and secure with safety prop.	Page 24
1.1 	Tilt cab Notes on tilting cab	Model 375, 673-679, 950-954, 957, 970-976	Page 25
1.2	Remove service cover	Model 668, 670	
2	Remove engine trim panel (7)		

3	Detach hydraulic lines (30) together with the securing plate (32) and the securing clamps (31) at the engine, and place to the side	Engine 906.920-923/925-928/939 with code (GS3) "hydraulic" transmission shift i Do not separate hydraulic lines	
4	Detach crankcase ventilation hose (4) at cylinder head cover (5)		
5	Take off cylinder head cover (5)	i Installation: Replace seals (2) and gasket (6) of cylinder head cover. Inspect gasket (3) between cylinder head cover and charge air manifold, replace gasket (3) if necessary. Nm	BA01.20-N-1001-01B
6	Install in the reverse order		

Nm Crankcase ventilation, cylinder head cover

Number	Designation	Engine 904.9, 906.9
BA01.20-N-1001-01B	Bolt of cylinder head cover to cylinder head	Nm 30

ENGINE 904.905 /906 /907 /910 /921

ENGINE 904.908 /923 in MODEL 668, 670

ENGINE 904.909 /911 /922 ## up to 040652



ENGINE 906.910 /911 /919 /920 /921 /922 /923 ## up to 047608

ENGINE 906.940 /941 ## up to 047608 in MODEL 957

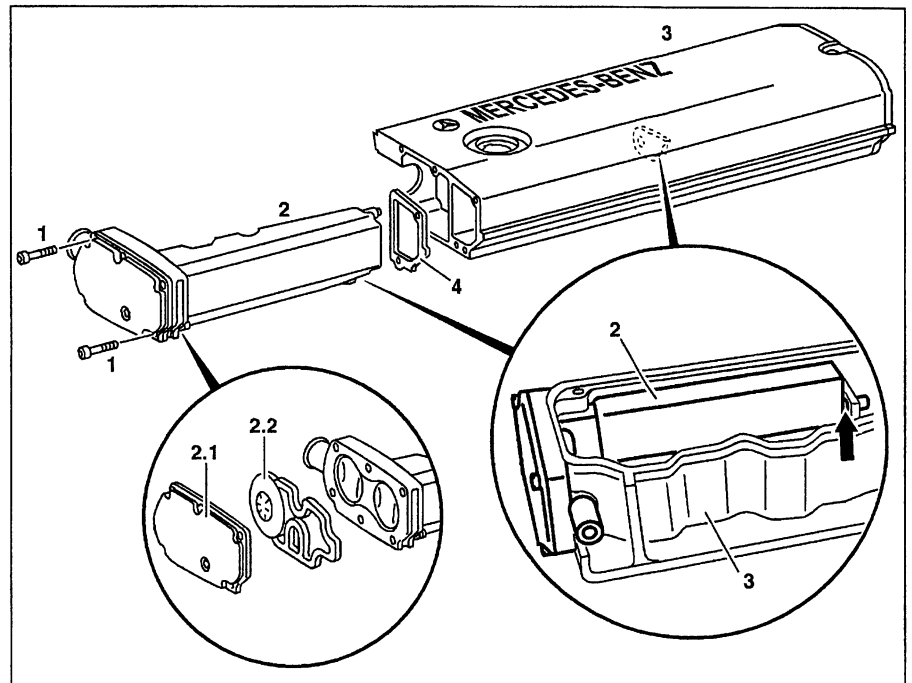
- 1 Bolt
- 2 Oil separator
- 2.1 Cover
- 2.2 Diaphragm
- 3 Cylinder head cover
- 4 Gasket



W01.20-0005-06

	Removing, installing		
1	Remove cylinder head cover (3)		Page 61
2	Detach oil separator (2) from cylinder head cover (3)	 Pull cover (2.1) off oil separator and remove diaphragm (2.2). Inspect diaphragm for damage, replace if necessary.	
3	Take off gasket (4) at oil separator (2)	 Installation: Install new gasket.	
4	Install in the reverse order		

ENGINE 904.909 /911 /922 ## as of 040653

ENGINE 906.910 /911 /920 /921 /922 /923 /940 /941 ## as of 047609

ENGINE 904.915 /916 /917, 906.915 /916 /919 /925 /926 /927 /928 /939 /942 /943

- 1 Cover
- 2 Diaphragm
- 3 Spring
- 4 Gasket

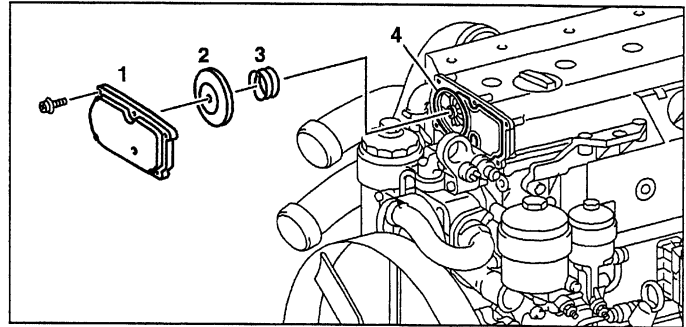

W01.20-1007-10

☒ ☒	Removing, installing		
1	Unclip engine wiring harness at cover (1)		
2	Take off cover (1) at cylinder head cover		
3	Remove diaphragm (2), spring (3) and gasket (4)	<input type="checkbox"/> i Inspect removed parts, replace if necessary.	
4	Install in the reverse order		

ENGINE 904.905 /906 /907 /908 /909 /910 /911 /915 /916 /917 /921 /922 /923, 906.910 /911 /915 /916 /919 /920 /921 /922 /923 /925 /926 /927 /928 /939 /940 /941 /942 /943 /951 /952



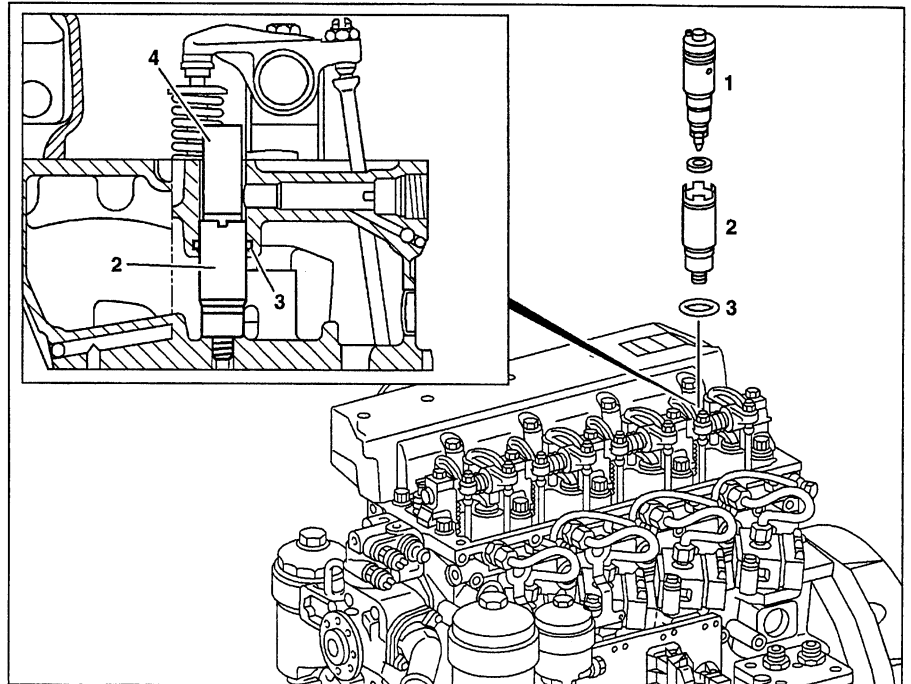

- 1 Nozzle holder combination
- 2 Protective sleeve
- 3 O-ring
- 4  Pronged wrench





W01.30-0015-06

Modification notes

7.7.98	Tightening torque and thread diameter of protective sleeve at cylinder head added	Step 3	
--------	---	--------	--

	Removing, installing		
 Danger!	Risk of injury to skin and eyes from scalding with hot coolant which splashes out. Risk of poisoning from swallowing coolant.	Do not open cooling system unless coolant temperature is below 90 °C. Open cap slowly and release the pressure. Do not pour coolant into beverage bottles. Wear protective gloves, protective clothing and eye protection.	Page 67
1	Drain coolant and collect	Engine 904.905- 907/921 Engine 904.908/923 Engine 904.909-911/915-917/922 Engine 906.910/911/915/916/919-923/ 925-928/939/940/941/942/943/951/952	WH2080 AP20.00-D-2080A AP20.00-W-2080A
	Notes on coolant		Page 67
2	Remove nozzle holder combination (1)	Engine 904.905-908/921 up to end no.040487 Engine 904.905-908/921 as of end no.040488, 904.909-911/915-917/921/922/923 Engine 906.910/911/915/916/919-923/ 925-928/939/940/941/942/943/951/952	AR07.03-W-6831A AR07.03-W-6831C
3	Use pronged wrench (4) to remove protective sleeve (2) from cylinder head		904 589 00 07 00

		 Installation: Clean sealing surfaces of protective sleeves (2) and of cylinder head. 	BA01.30-N-1001-01C
4	Remove O-ring (3) from cylinder head		BR00.45-Z-1018-06A
5	Install in the reverse order		
6	Inspect coolant level	Engine 904.905- 907/921 Engine 904.908/923 Engine 904.909-911/915-917/922 Engine 906.910/911/915/916/919-923/ 925-928/939/940/941/942/943/951/952	WH2080 AP20.00-D-2080A AP20.00-W-2080A

 **Cylinder head**

Number	Designation	Engine 904.9, 906.9		
BA01.30-N-1001-01C	Protective sleeve to cylinder head	M 12x1	Nm	40
		M 14x1	Nm	45

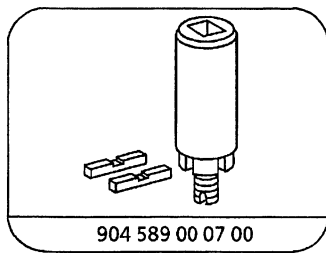

Pronged wrench

Repair products

Number	Designation	Order no.
BR00.45-Z-1018-06A	ATE grease	-

AS20.00-Z-0001-01A	Risk of injury to skin and eyes from scalding from hot coolant which splashes out..Risk of poisoning from swallowing coolant.	Do not open the cooling system unless the coolant temperature is below 90 °C. Open cap slowly and allow the pressure to release. Do not pour coolant into containers for drinks. Wear protective gloves, protective clothes, and eye protection.	⚠ Danger!
--------------------	---	--	-----------

Possible dangers

Risk of injury

The cooling system is pressurized when the engine is warm. Risk of scalding from hot coolant which splashes out if the cooling system is opened suddenly.

Risk of poisoning

If coolant is swallowed, the person affected is likely to show signs of poisoning such as headaches, giddiness and stomach aches, paralysis of the respiratory system, unconsciousness, nausea, and convulsions.

Protective measures/rules of conduct

- Allow cooling system to cool down to a coolant temperature of less than 90 °C.
- Open coolant system cap slowly; open a conventional type of coolant system cap to the first detent and open a screw-type coolant system cap about 1/2 turn, and allow the pressure to release.
- Wear protective gloves, protective clothes, and eye protection.
- Do not pour coolant into containers for drinks.

First aid measures

- Pour large quantities of cold water over the affected area of skin and cover over with sterile bandages.
- Have person affected drink plenty of water to which medicinal carbon has been added.
- Consult a doctor if the person affected has severe burns or has swallowed considerable quantities.

AH20.00-N-2080-01A	Instructions re coolant	All engines	ⓘ
--------------------	-------------------------	-------------	---

Coolant composition

Passenger car and commercial vehicle engine (normal case):
50 % by volume water and
50 % by volume anticorrosion/antifreeze agent.
See **MB Specifications for Service Products** for differing coolant composition for commercial vehicle engines.

Purposes of anticorrosion/antifreeze agent

- Corrosion and cavitation protection for all components in the cooling system
- Antifreeze protection
- Increasing boiling point so that the coolant does not evaporate so rapidly. Ejection of coolant is avoided at high coolant temperatures.

Antifreeze protection

50 % by volume of anticorrosion/antifreeze concentration offers antifreeze protection down to approx. **-37 °C**.
A higher concentration is only practical at even lower ambient temperatures.
55 % by volume of anticorrosion/antifreeze concentration offers antifreeze protection down to approx. **-45 °C**.

ⓘ A concentration of anticorrosion/antifreeze agent higher than 55 % by volume should not be used as the maximum antifreeze protection is thus reached. An even higher concentration again reduces the antifreeze protection and impairs heat dissipation.

Water

Use water which is clean and not too hard. Drinking water frequently, but not always, satisfies the requirements. The contents of dissolved substances in the water can be of importance for the occurrence of corrosion. In cases of doubt, analyze the water. See **MB Specifications for Service Products** for fresh water regulations.

Operation of monitoring of coolant

Inspect coolant for resistance to low temperatures before the start of the cold season of the year.
In countries with high ambient temperatures, inspect the anticorrosion/antifreeze concentration once a year.
The corrosion protection in the coolant is reduced during operation. Such coolants have a severely corrosive effect. The maximum permissible period of use of the coolant is for passenger car and commercial vehicle engines (normal case) **3 years**.
See **MB Specifications for Service Products** for the period of use for differing coolant composition for commercial vehicle engines.

ⓘ Before pouring fresh coolant into the system, flush the used coolant out of the cooling system. Clean cooling system if severe soiling or oil contamination exist.

Disposing of coolants

Observe legal regulations and local wastewater regulations.

For workshops located in the Federal Republic of Germany see:

"Umweltschutz-Handbuch für Kfz-Reparaturbetriebe"
(*Environmental protection manual for vehicle repair workshops*)

Publisher: Verband der Automobilindustrie e.V. (VDA)
D-60625 Frankfurt am Main, Westendstraße 61

ENGINE 904.905 /906 /907 /909 /910 /911 /915 /916 /917 /921 /922, 906.910 /911 /915 /916 /919 /920 /921 /922 /923 /925 /926 /927 /928 /939 /940 /941 /942 /943 /951 /952

- 1 Noise encapsulation
- 2 Charge air manifold
- 3 Injection line
- 4 Rocker arm assembly
- 5 Valve bridge
- 6 Tappet rod
- 7 Gasket
- 8 Connection piece
- 9 Bolt
- 10 Connection fitting
- 11 Engine wiring harness
- 12 Coolant line

B8 Coolant temperature sensor

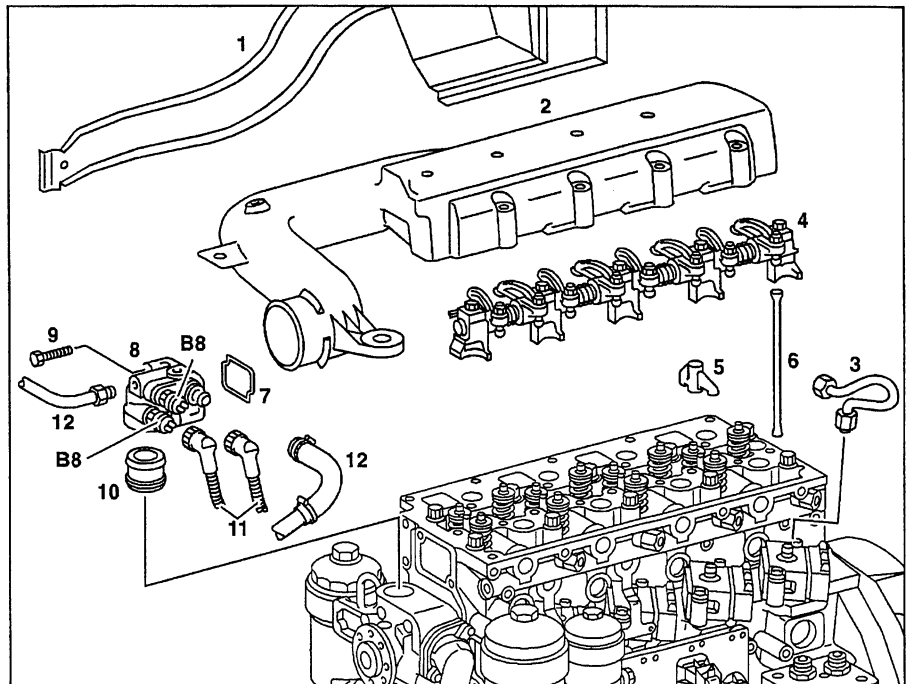

W01.30-0016-06

- 13 Exhaust manifold with turbocharger
- 14 Constant throttle line
- 15 Compressor coolant line
- 16 Leak fuel line
- 17 Cylinder head bolt
- 18 Cylinder head
- 19 Cylinder head gasket
- 20 Centering sleeve

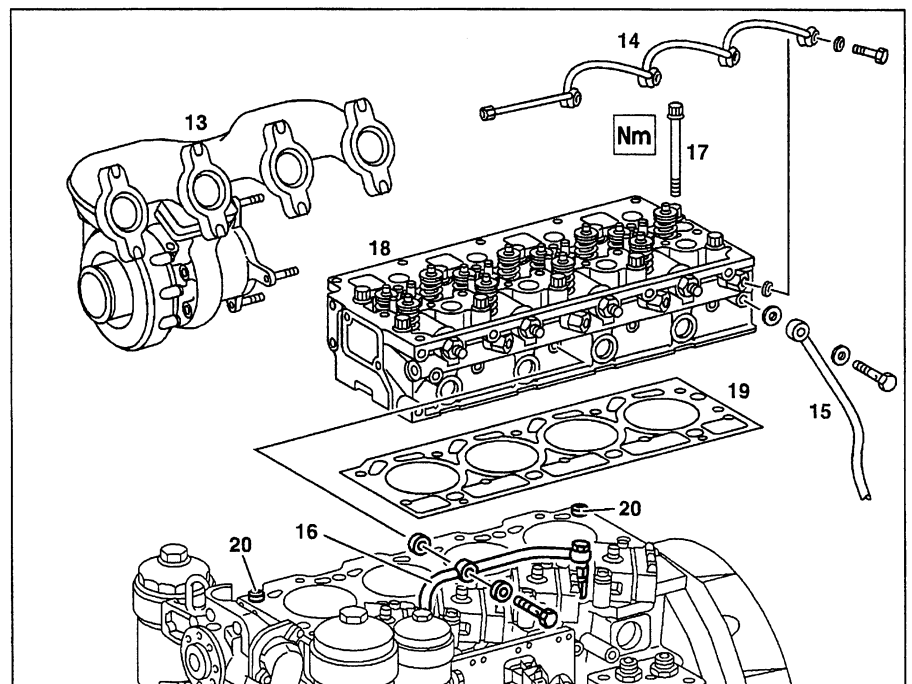



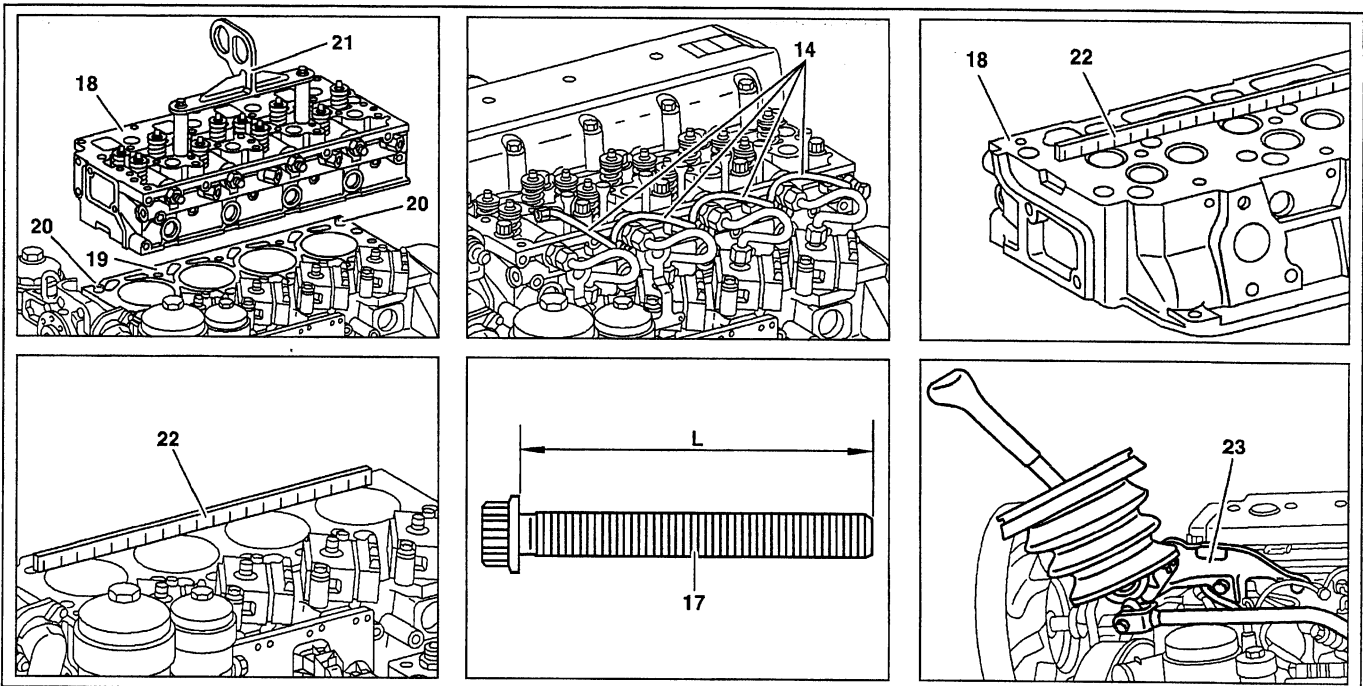









W01.30-0017-06



W01.30-0018-09

- 14 Constant throttle line
- 17 Cylinder head bolt shank length (L)
- 18 Cylinder head
- 19 Cylinder head gasket
- 20 Centering sleeve
- 21 Lifting device
- 22 Knife-edge straightedge
- 23 Shift lever with bracket

	Removing, installing		
⚠ Danger!	Risk of injury to skin and eyes from scalding with hot coolant which splashes out. Risk of poisoning from swallowing coolant.	Do not open cooling system unless coolant temperature is below 90 °C. Open cap slowly and release the pressure. Do not pour coolant into beverage bottles. Wear protective gloves, protective clothing and eye protection.	Page 67
1	Drain coolant	Engine 904.905- 907/921 Engine 904.909-911/915-917/922 Engine 906.910/911/915/916/919-923/ 925-928/939/940/941/951/952	WH2080 AP20.00-W-2080A
	Notes on coolant		Page 67
2	Remove noise encapsulation (1)		
3	Detach shift lever with bracket (23) at cylinder head (18)		
4	Remove charge air manifold (2)	Engine 904.905- 907/921 Engine 904.909-911/915-917/922 Engine 906.910/911/915/916/919-923/ 925-928/939/940/941/942/943/951/952	AR09.41-W-8681A AR09.41-W-8681C
5	Detach exhaust manifold (13) at cylinder head (18)		AR14.10-W-3915A
6	Take off bracket for hydraulic lines at cylinder head (18)	Engine 906.920-923/925-928/939 with code (GS3) "hydraulic" transmission shift	
N	Remove injection lines (3)		AR07.15-W-9235A
8	Detach constant throttle lines (14) at cylinder head (18)		

9	Detach leak fuel line (16) at cylinder head (18)		
10	Detach coolant line of compressor (15) at cylinder head (18)		
11	Separate engine wiring harness (11) at both coolant temperature sensors (B8)		
12	Remove connection piece (8) at cylinder head (18) and at coolant pump	 Installation: Replace connection fitting (10) and gasket (7). 	Page 73 BA20.10-N-1003-01C
13	Remove rocker arm assembly (4)	Engine 904.905- 907/921 Engine 904.909-911/915-917/922 Engine 906.910/911/915/916/919-923/ 925-928/939/940/941/942/943/951/952	AR05.00-W-5521A AR05.00-W-5521C
14	Remove tappet rods (6)	 Installation: Ensure tappet rods are correctly installed in the tappets.	
15	Unscrew cylinder head bolts (17)	 Installation: Pay attention to tightening instruction for cylinder head bolts.  	Page 74 BA01.30-N-1002-01C 422 589 02 09 00
16	Lift off cylinder head with the lifting device (21) and take off cylinder head gasket (19)	  Do not damage the installed nozzle holder combinations.  Seal oil and coolant drillings at crankcase. Clean crankcase contact surface and inspect.  Installation: Use new cylinder head gasket. Pay attention to installation position.	904 589 01 63 00
17	Clean threaded holes and oil and coolant drillings in crankcase		
	Inspecting		
18	Measure shank length of cylinder head bolts (17)	If the max. shank length (L) has been exceeded, replace cylinder head bolt.	BE01.30-N-1001-01B
19	Inspect cylinder head (18) for cracks and damage	 If cracks or damage present, replace cylinder head	
20	Use a knife-edge straightedge to inspect flatness of cylinder head (18) and crankcase contact surface	  If flatness of cylinder head is not to specification ↓ Machine cylinder head contact surface	BE01.30-N-1002-02B BE01.40-N-1013-02B WH58.30-Z-1002-12A Page 78
21	Install in the reverse order		
22	Fill engine oil circuit		AR18.00-W-1600A
23	Check engine oil level with dipstick	Engine 904.905- 907/921	WH0101.40
24	Inspect coolant level	Engine 904.905- 907/921	WH2080

		Engine 904.909-911/915-917/921/922 Engine 906.910/911/915/916/919-923/ 925-928/939/940/941/942/943/951/952	AP20.00-W-2080A
25	<p>⚠ Danger!</p> <p>Risk of accident from vehicle starting off by itself when engine running. Risk of injury from bruises and burns if you hold your hand into engine when it is started or when it is running.</p> <p>Start engine and observe oil pressure gage at idle speed</p>	<p>Secure vehicle to prevent it moving off by itself.</p> <p>Wear closed and close-fitting work clothes. Do not grasp hot or rotating parts.</p> <p>ⓘ Start engine with the starter for not more than 90 s. Wait about 2 min. before repeating start operation. Do not rev up engine so long as no oil pressure is indicated.</p> <p>ⓘ The oil pressure gage must indicate oil pressure after about 10 s.</p>	<p>Page 33</p> <p>BE18.00-N-1001-01C</p>
26	Switch off engine and inspect for leaks		
27	Inspect engine oil level at the electric gage	Model 950 - 957	AP18.00-W-0101-07A

Inspection data of cylinder head bolts

Number	Designation	Engine 904.9, 906.9
BE01.30-N-1001-01B	Cylinder head bolt	Thread diameter M 16×2
		Shank length when new mm 149.0
		Shank length mm ≤ 151.0

Test values for cylinder head

Number	Designation	Engine 904.9	Engine 906.9
BE01.30-N-1002-02B	Permissible variation of flatness of bottom contact surface in longitudinal direction	Over entire length mm 0.05	0.07
		Over a length of 150 mm mm 0.02	0.02

Inspection data of crankcase

Number	Designation	Engine 904.9, 906.9
BE01.40-N-1013-02B	Crankcase - flatness of contact surface	Over entire length mm 0.030
		Over a length of 150 mm mm 0.015 in longitudinal and transverse direction

Test data of engine oil pressure

Number	Designation	Engine 904.9, 906.9
BE18.00-N-1001-01C	Engine oil pressure at	Idle speed bar ≥ 0.5
		Maximum speed bar ≥ 2.5

Nm Cylinder head

Number	Designation	Engine 904.9, 906.9	
BA01.30-N-1002-01C	Cylinder head bolts to crankcase	1st stage	Nm 20
		2nd stage	Nm 70
		3rd stage	Nm 170
		4th stage	Nm 280
		5th stage	∠° 90
		6th stage	∠° 90

Nm Coolant pump, coolant thermostat

Number	Designation	Engine 904.9, 906.9	
BA20.10-N-1003-01C	Bolt of connection piece of coolant pump to cylinder head	Nm	25

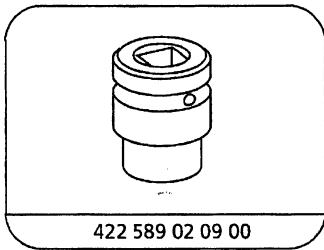

422 589 02 09 00

Wrench socket

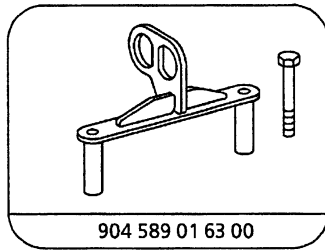

904 589 01 63 00

Lifting device

Commercially available tools (see Workshop Equipment Manual)

Number	Designation	Make (e. g.)	Order no.
WH58.30-Z-1002-12A	Knife-edge straightedge	Hahn and Kolb Borsigstr. 50 D-70469 Stuttgart	37 550 050

AR20.10-W-1290-02A	Removing, installing connection piece of coolant pump to cylinder head		
--------------------	--	--	--

Nm Coolant pump, coolant thermostat

Number	Designation	Engine 904.9, 906.9	
BA20.10-N-1003-01C	Bolt of connection piece of coolant pump to cylinder head	Nm	25

- 1 Disconnect coolant lines (1, 2) at connection piece (3).
- 2 Unscrew bolts (4) and take off crankcase ventilation line (5).
- 3 Pull connection piece (3) up and out of connection fitting (6).
- 4 Replace gasket (7) and connection fitting (6).

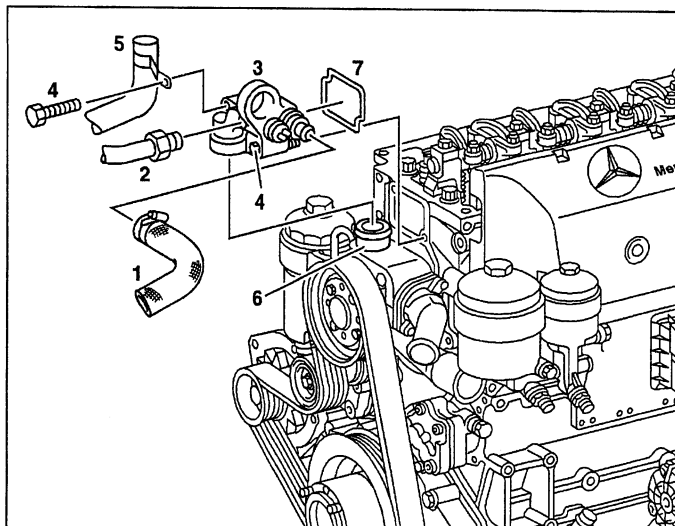

W20.10-0014-11

AR01.30-W-5800-07A	Tightening specification of cylinder head bolts		
--------------------	---	--	--

Nm Cylinder head

Number	Designation	Engine 904.9, 906.9	
BA01.30-N-1002-01C	Cylinder head bolts to crankcase	1st stage	Nm 20
		2nd stage	Nm 70
		3rd stage	Nm 170
		4th stage	Nm 280
		5th stage	Δ° 90
		6th stage	Δ° 90

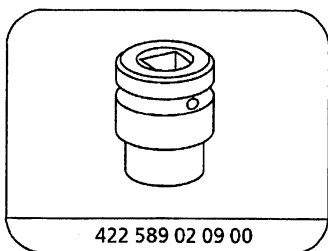

422 589 02 09 00

Wrench socket

Oil cylinder head bolts with engine oil and tighten fully with the  wrench socket.

 It is important to observe all the tightening torque stages and the correct order (refer to tightening diagram) in order to achieve uniform contact pressure of the cylinder head gasket.



If the tightening torque is exceeded at a cylinder head bolt, unscrew all the cylinder head bolts, inspect the shank length of the cylinder head bolt in question (replace if necessary) and tighten all bolts again, beginning with stage 1.

 The cylinder head bolts must not be re-tightened.

Tightening diagram

Engine 904

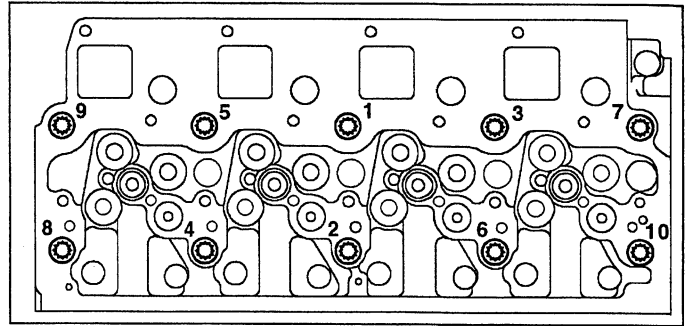

W01.30-0005-10

Engine 906

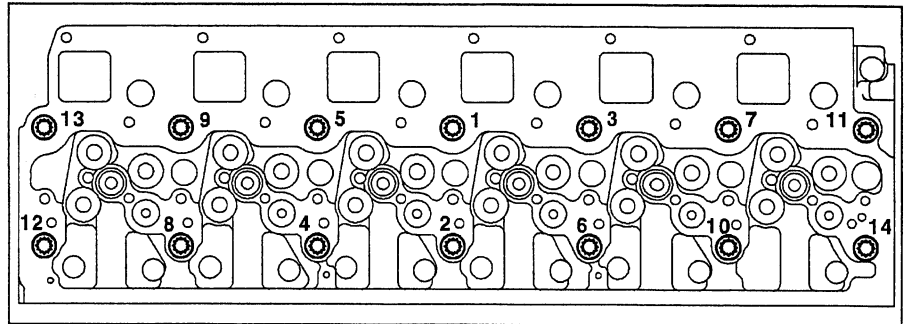

W01.30-0020-04



ENGINE 904.905 /906 /907 /909 /910 /911 /915 /916 /917 /921 /922, 906.910 /911 /915 /916 /919 /920 /921 /922 /923 /925 /926 /927 /928 /939 /940 /941 /942 /943 /951 /952

ENGINE 904.908 /923 with CODE (MB1) Engine brake with constant throttle

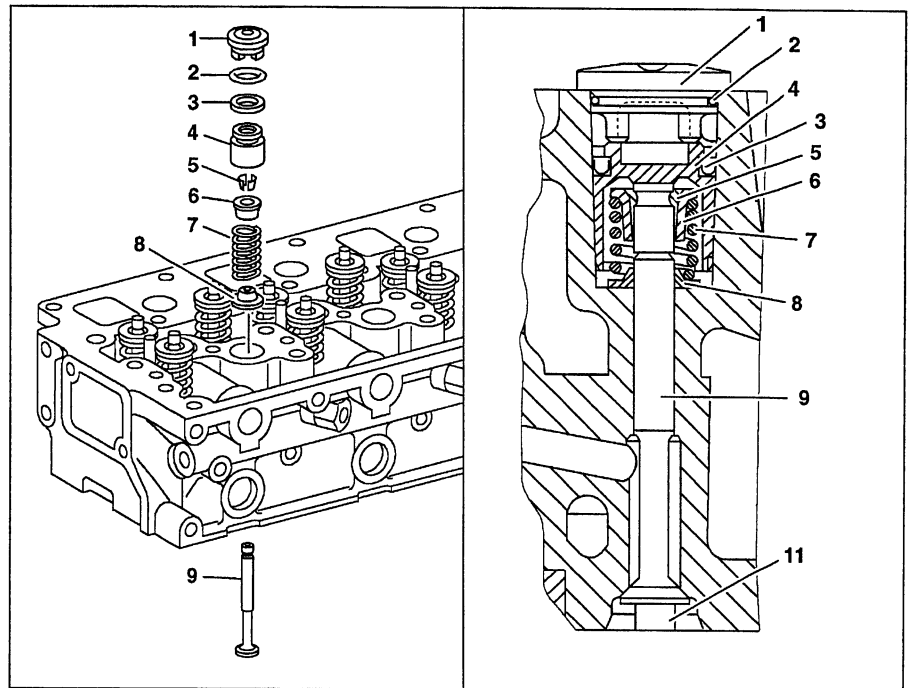
- 1 End cover
- 2 O-ring.
- 3 Seal
- 4 Pistons
- 5 Locking wedge
- 6 Top spring retainer
- 7 Spring
- 8 Bottom spring retainer
- 9 Valve
- 11 Spacer



W01.50-0001-06

- 4 Pistons
- 5 Locking wedge
- 6 Top spring retainer
- 7 Spring
- 12  Pliers
- 13  Spring retainer compressor
- 15  Magnetic pin

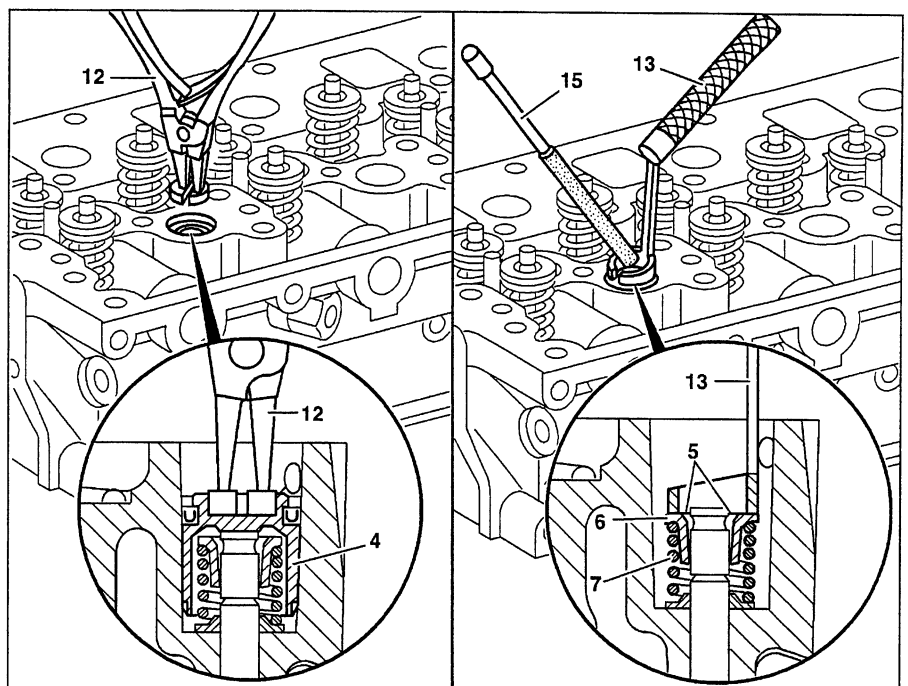

W01.50-0010-06

	Removing, installing		
1	Remove cylinder head	Engine 904.905-907/909-911/915-917/921/922, Engine 906.910/911/915/916/919-923/925-928/939/940/941/942/943/951/952 Engine 904.908/923	Page 69 AR01.30-D-5800D

2	Remove nozzle holder combinations	Engine 904.905- 908/921 up to end no. 040487 Engine 904.905-908/921 as of end no. 040488, 904.909-911/915-917/922/923 Engine 906.910/911/915/916/919-923/925-928/939/940/941/942/943/951/952	AR07.03-W-6831A AR07.03-W-6831C
3	Remove end cover (1) at cylinder head (10)	i Installation: Replace O-ring (2).	
4	Insert a suitable spacer (11) between valve disk and base	i Height of spacer approx. 5.3 mm	
5	Use pliers (12) to remove piston (4)	S i Installation: Oil piston and seal (3) and do not damage.	442 589 00 37 00
6	Inspect seal (3) at piston (4)	i If wear or damage present ↓ Replace piston and seal.	
7	Remove locking wedges (5)	Compress spring with spring retainer compressor (13) and take out locking wedges with magnetic pin (15). i Installation: Locking wedges must lock in place. S S	210 589 00 40 00 442 589 05 63 00
8	Relieve pressure on spring (7), take out top spring retainer (6), spring and bottom spring retainer (8)	i Do not mix up top spring retainer and spring guide. i Installation: Place spring guide, spring and spring retainer onto the stem of the valve of the constant throttle.	
9	Turn cylinder head (10) and pull out valve (9)	Mark valve. i Installation: Oil valve stem, push in valve and place spacer (11) (height approx. 5.3 mm) below the valve disk.	
10	Install in the reverse order		

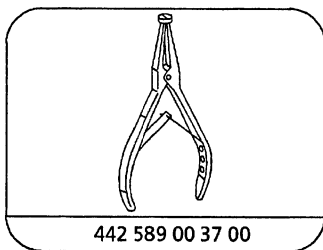

Pliers

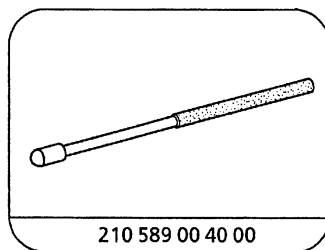

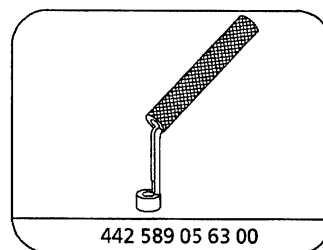

Magnetic pin



Spring disk compressor



ENGINE 904.905 /906 /907 /908 /909 /910 /911 /915 /916 /917 /921 /922 /923, 906.910 /911 /915 /916 /919 /920 /921 /922 /923 /925 /926 /927 /928 /939 /940 /941 /942 /943 /951 /952



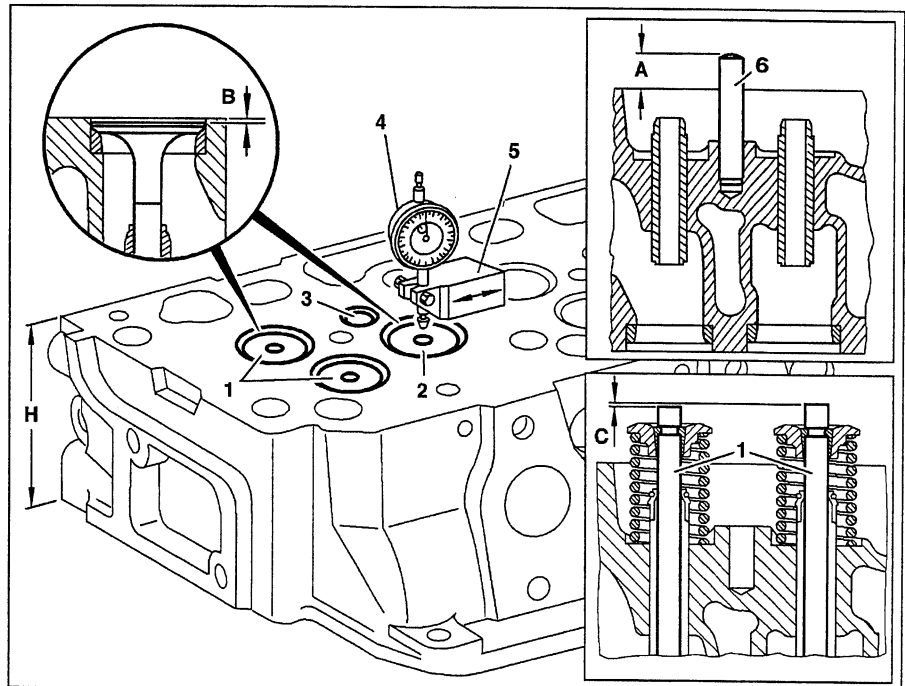



- 1 Inlet valve
 2 Exhaust valve
 3 Constant throttle valve
 4  Dial gage
 5  Dial gage holder
 6 Guide pin
 (engine 904.905-908/921 up to end no. 039739)

- A Projection of guide pin
 (engine 904.905-908/921 up to end no. 039739)
 B Valve setback
 C Difference between both inlet valve stem ends
 (engine 904.905-908/921 as of end no. 039740, 904.909-911/915-917/922/923, 906.910/911/915/916/919-923/925-928/939/940/941/942/943/951/952)
 H Height of cylinder head



W01.30-0019-06

	Removing		
1	Remove cylinder head	Engine 904.905-907/909-911/915-917/921/922 Engine 906.910/911/915/916/919-923/925-928/939/940/941/942/943/951/952 Engine 904.908/923	Page 69 AR01.30-D-5800D
2	Remove nozzle holder combinations	Engine 904.905-908/921 up to end no. 040487 Engine 904.905-908/921 as of end no. 040488, Engine 904.909- 911/915- 917/921/922/923, 906.910/911/915/916/919-923/925-928/939/940/941/942/943/951/952	AR07.03-W-6831A AR07.03-W-6831C
3	Remove valves (1, 2)		AR05.30-W-3511A
4	Remove constant throttle valve (3)	Engine 904.905-907/909-911/915-917/921/922 Engine 906.910/911/915/916/919-923/925-928/939/940/941/942/943/951/952 Engine 904.908/923	Page 76
	Inspecting		
5	Measure cylinder head overall height (H) and variation of parallelism from top to bottom contact surface	 If the height is less than the permissible minimum height, replace cylinder head.	BE01.30-N-1001-02B
6	Inspect flatness of cylinder head contact surface (combustion chamber side)	Permissible variation of flatness of bottom contact surface in longitudinal direction	BE01.30-N-1002-02B
	Machining		

N	Machine cylinder head contact surface (combustion chamber side)	<p>Ⓛ Surface finish (peak-to-valley height R_{3z}/ waviness W_t) of cylinder head contact surface must be maintained.</p> <p>i Only machine cylinder head contact surface if an impermissible variation of the flatness is measured in longitudinal direction, or if porous or damaged points are present. The stock removal at the cylinder head must be such that the permissible minimum height (H) is maintained.</p>	BE01.30-N-1003-02B BE01.30-N-1002-02B
8	Clean cylinder head		
	Measuring		
9	Once again measure cylinder head overall height and variation of parallelism from top to bottom contact surface		BE01.30-N-1001-02B
10	Insert valves (1, 2) into the cylinder head	i Pay attention to marking of valves.	
11.1	Measure valve setback (B) to cylinder head	<p>Engine 904.905-908/921 up to end no. 039739</p> <p>Measure valve setback at both inlet valves and at exhaust valve and note</p> <p></p> <p></p> <p>i If the measurement obtained is not within the permissible tolerance ↓</p> <p>Machine valve seat rings.</p>	<p>Page 81</p> <p>BE05.30-N-1001-01B</p> <p>001 589 53 21 00</p> <p>343 589 00 40 00</p> <p>AR05.30-W-4511A</p>
11.2	Measure valve setback (B) to cylinder head, and permissible difference (C) between both inlet valve stems	<p>Engine 904.905-908/921 as of end no. 039740, 904.909-911/915-917/922/923 Engine 906.910/911/915/916/919-923/ 925-928/939/940/941/942/943/951/952</p> <p>Measure valve setback at both inlet valves and at exhaust valve and note</p> <p>The difference between both inlet valve stem ends must not be exceeded.</p> <p></p> <p></p> <p></p> <p>i If the measurements obtained are not within the permissible tolerance ↓</p> <p>Machine valve seat rings.</p>	<p>Page 81</p> <p>BE05.30-N-1001-01B</p> <p>BE05.30-N-1014-01B</p> <p>001 589 53 21 00</p> <p>363 589 02 21 00</p> <p>343 589 00 40 00</p> <p>AR05.30-W-4511A</p>
12	Measure projection of guide pin (6) from cylinder head and adjust to correct projection	Engine 904.905-908/921 up to end no. 039739	BE05.30-N-1003-04B
	Installing		
13	Install constant throttle valve (3)		Page 76
14	Install valves (1, 2)		AR05.30-W-3511A
15	Install nozzle holder combinations	Engine 904.905-908/921 up to end no. 040487	AR07.03-W-6831A

		Engine 904.905-908/921 as of end no. 040488 Engine 904.909-911/915-917/922/923 Engine 906.910/911/915/916/919-923/ 925-928/939/940/941/942/943/951/952	AR07.03-W-6831C
16	Install cylinder head	Engine 904.905-907/909-911/915-917/ 921/922 Engine 906.910/911/915/916/919- 923/ 925-928/939/940/941/942/943/951/952 Engine 904.908/923	Page 69 AR01.30-D-5800D

Test values for cylinder head

Number	Designation		Engine 904.9	Engine 906.9	
BE01.30-N-1001-02B	Height of cylinder head	when new	mm	107.9-108.1	107.9-108.1
		after stock removal	mm	106.9	106.9
BE01.30-N-1002-02B	Permissible variation of flatness of bottom contact surface in longitudinal direction	Over entire length	mm	0.05	0.07
		Over a length of 150 mm	mm	0.02	0.02
BE01.30-N-1003-02B	Peak-to-valley height (R _z) of cylinder head contact surface		µm	8-16	8-16

Inspection data of valves

Number	Designation		Engine 904.9 up to end no. 026066	Engine 904.9 as of end no. 026067, engine 906.9
BE05.30-N-1001-01B	Valve setback to cylinder head contact surface	mm	1.1-1.5	1.1-1.5
BE05.30-N-1014-01B	Permissible difference of inlet valves measured between cylinder head and valve stem end	mm	0.2	0.2

Inspection data of valve timing

Number	Designation		Engine 904.9, 906.9
BE05.30-N-1003-04B	Valve bridge guide pin projection from cylinder head (A)	mm	25.1-25.5
		See figure	-

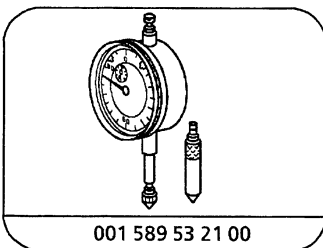

Dial gage

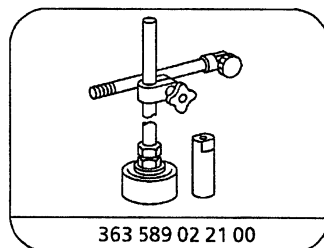

Dial gage holder

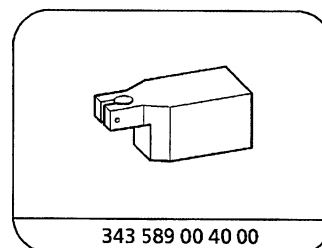

Dial gage holder

AR05.30-W-4100-01A	Measuring amount by which valve stands back to cylinder head		
--------------------	--	--	--

Test data of valves

Number	Designation	Engine 904.9 up to end no. 026066	Engine 904.9 as of end no. 026067, engine 906.9
BE05.30-N-1001-01B	Amount by which valve stands back relative to cylinder head contact surface	mm 1.1–1.5	1.1–1.5

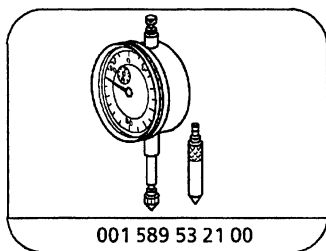



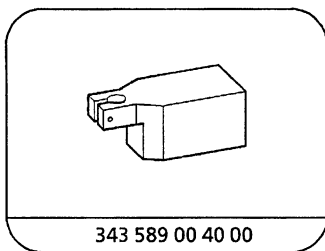

Dial gage



Dial gage holder



Valve disk (3) should be making contact with valve seat.

- 1 Attach  dial gage (1) to  dial gage holder (2).
- 2 Mount  dial gage (1) with a preload onto the plane face of the cylinder head.
- 3 Set scale of dial gage to "0".
- 4 Move  dial gage (1) sufficiently until the tracer pin is touching the valve disk (3).

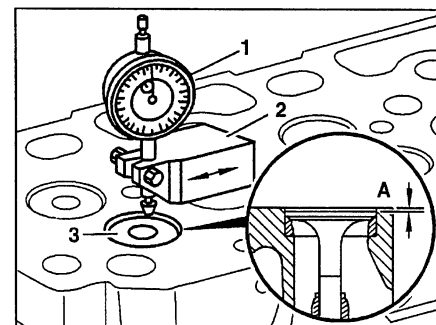

W05.30-0060-01



If the reading obtained (A) is not within the permissible tolerance, inspect valve seat ring or the valve disk.

AR05.30-W-4100-01C	Measuring amount by which valve stands back to cylinder head		
--------------------	--	--	--

Inspection data of valves

Number	Designation	Engine 904.9 up to end no. 026066	Engine 904.9 as of end no. 026067, engine 906.9
BE05.30-N-1001-01B	Valve setback to cylinder head contact surface	mm 1.1-1.5	1.1-1.5
BE05.30-N-1014-01B	Permissible difference of inlet valves measured between cylinder head and valve stem end	mm 0.2	0.2

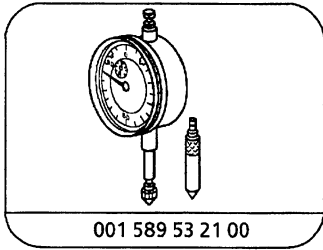

001 589 53 21 00

Dial gage

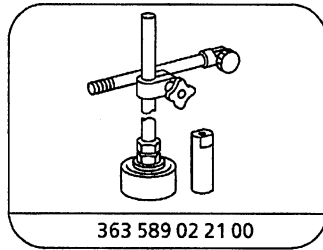

363 589 02 21 00

Dial gage holder

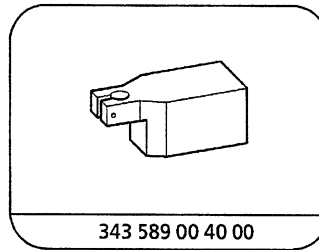

343 589 00 40 00

Dial gage holder

i The valve disk (3) must be resting against the valve seat.

- 1 Attach dial gage (1) to dial gage holder (2).
- 2 Mount dial gage (1) with a preload on the plane face of the cylinder head.
- 3 Set scale of dial gage to "0".
- 4 Move dial gage (1) sufficiently so that the tracer pin is positioned on the valve disk (3).

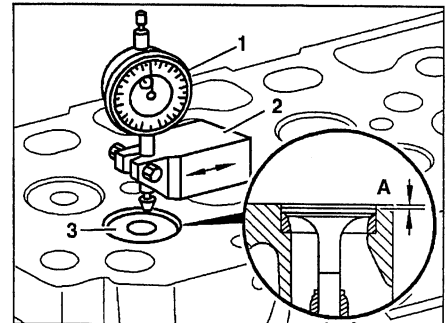

W05.30-0060-01

i If the inspection reading obtained (A) is not within the permissible tolerance, inspect the valve seat ring or the valve disk.

- 5 Attach dial gage (1) to dial gage holder (4) and mount on the top contact surface of the cylinder head.
- 6 Mount dial gage (1) with a preload onto one of the two inlet valve stem ends (5).
- 7 Set scale of dial gage to "0".
- 8 Pull back tracer pin at dial gage (1). Mount dial gage (1) onto the other inlet valve stem end (5) and take reading.

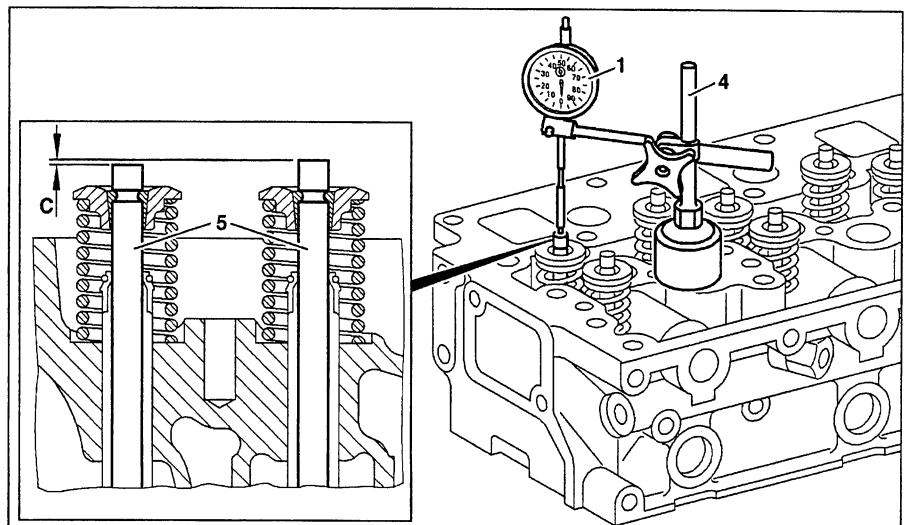

W05.30-0058-05

i Permissible difference (C) between both inlet valve stem ends (5) must not be exceeded.

If the reading obtained (C) is not within the permissible tolerance, inspect the valve seat ring or the valve.

ENGINE 904.905 /906 /907 /908 /909 /910 /911 /915 /916 /917 /921 /922 /923, 906.910 /911 /915 /916 /919 /920 /921 /922 /923 /925 /926 /927 /928 /939 /940 /941 /942 /943 /951 /952

Shown on engine 904

- 1 Screw plug M16x1.5
- 2 Screw plug M14x1.5
- 3 Screw plug M20x1.5
- 4 Screw plug M18x1.5

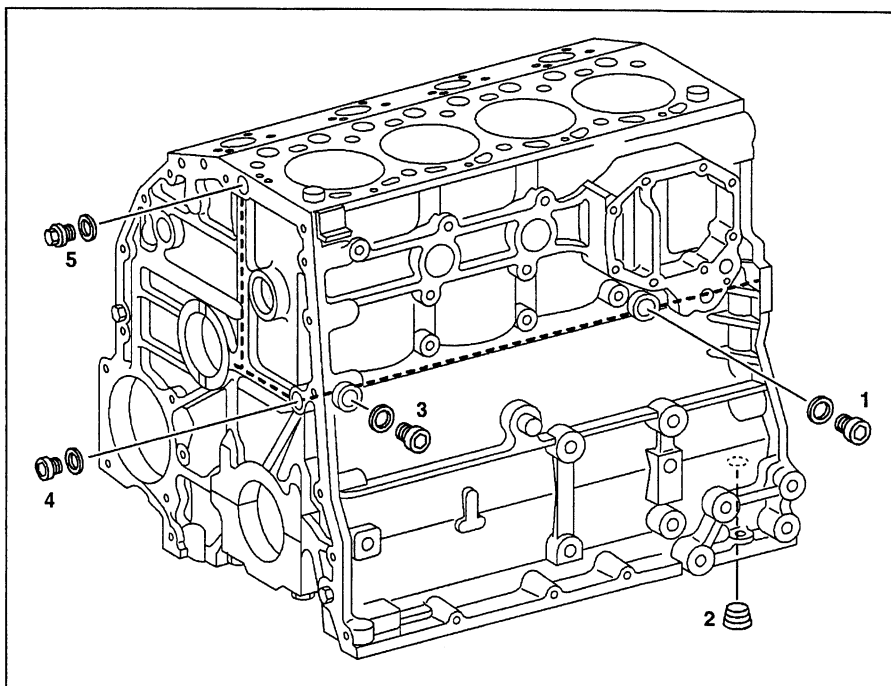



W01.40-1018-06

	Removing, installing		
1	Remove crankshaft		AR03.20-W-4351A
2	Remove screw plug (4) and clean main oil gallery with compressed air	 The main oil gallery for lubricating the rocker arm assembly must be cleaned first of all. Installation: Replace seal!	BA01.40-N-1006-01C
3	Remove screw plugs (1, 2, 3) and clean main oil gallery with compressed air	 Installation: Replace seals.	BA01.40-N-1006-01C
4	Install in the reverse order		

Crankcase, timing case cover, end cover

Number	Designation		Engine 904.9, 906.9
BA01.40-N-1006-01C	Screw plugs of crankcase	M14x1.5	Nm 35
		M16x1.5	Nm 35
		M18x1.5	Nm 40
		M20x1.5	Nm 50

ENGINE 904.905 /906 /907 /908 /909 /910 /911 /915 /916 /917 /921 /922 /923, 906.910 /911 /915 /916 /919 /920 /921 /922 /923 /925 /926 /927 /928 /939 /940 /941 /942 /943 /951 /952







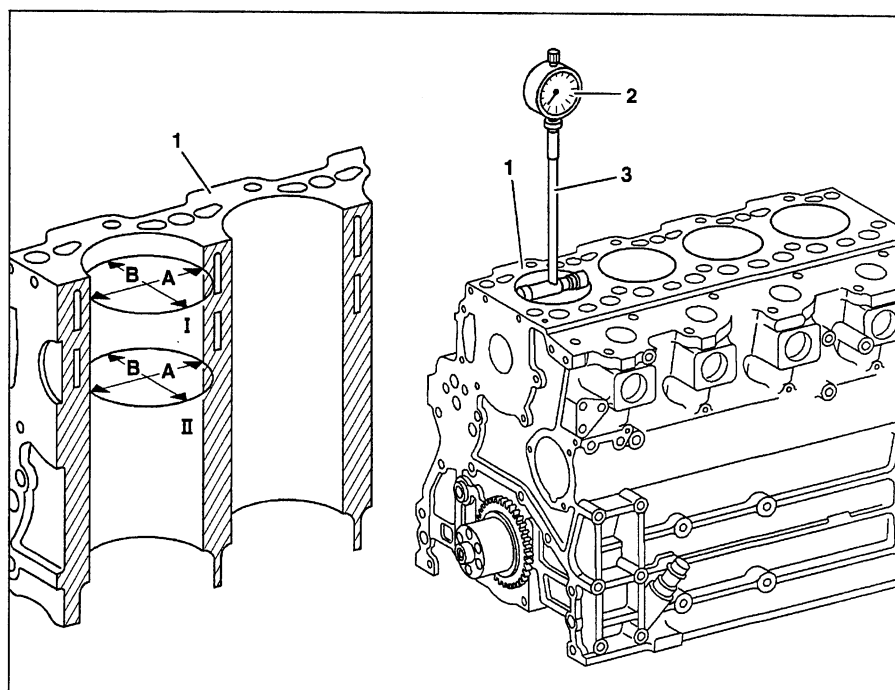



- 1 Crankcase
 2  Dial gage
 3  Quick calipers for internal measurements

A,B Directions of measurements in crankcase

- I Measuring point at upper reversal point of first piston ring
 II Measuring point in middle of cylinder wall



W01.40-0034-06

	Removing, installing		
1	Remove cylinder head	Engine 904.905-907/909-911/ 915-917/921/922 Engine 906.910/911/915/916/919-923/ 925-928/939/940/941/942/943/951/952 Engine 904.908/923	Page 69 AR01.30-D-5800D
2	Clean cylinder walls		
	Inspecting		
3	Inspect cylinder walls or cylinder liners	 The cylinder walls or the cylinder liners must not display any scroch streaks. Individual slight drawing scores are not critical.	Page 53
	Notes for assessing wear to cylinder wall in the case of dust damage		
	Measuring		
4	Use the micrometer to set dial gage (2) and quick calipers (3) to the cylinder liner inner \varnothing	 Pretension 5 mm.   	BE01.40-N-1001-02B 001 589 53 21 00 WH58.30-Z-1009-12A WH58.30-Z-1027-12A
5	Measure inner \varnothing diameter of cylinder wall or cylinder liner and set dial gage (2) to "0"	 Measure in the unworn area (top land zone) above the top reversal point of the first piston ring. Directions of measurements in direction of travel (A) and in transverse direction (B).	BE01.40-N-1001-02B

		Variation of cylinder shape	BE01.40-N-1002-02B
6	Measure difference in diameter of cylinder wall or cylinder liner	<p>i Measure wear of cylinder wall or cylinder liner at the measuring points (I , II) in direction of travel (A) and in transverse direction (B).</p> <p>ⓘ The specifications must be maintained. The installed cylinder liners must not be machined. ↓</p> <p>i If variation from tolerance ↓</p> <p>Widen cylinder bore in crankcase ↓</p> <p>Install cylinder liners or ↓</p> <p>Replace cylinder liners</p>	BE01.40-N-1003-02B
N	Install in the reverse order		

Page 88

Page 92

Page 90

Inspection data of crankcase

Number	Designation	Engine 904.9, 906.9
BE01.40-N-1001-02B	Cylinder wall or cylinder liner inner Ø	Code letter A mm 101.985-101.991
		Code letter B mm 101.992-102.008
		Code letter C mm 102.009-102.015
BE01.40-N-1002-02B	Cylinder wall - variation of cylinder shape	mm 0.012
BE01.40-N-1003-02B	Wear of cylinder wall or cylinder liner measured in direction of travel and transverse direction	Top reversal point of first piston ring mm ≤0.1
		In middle of cylinder wall mm ≤0.05

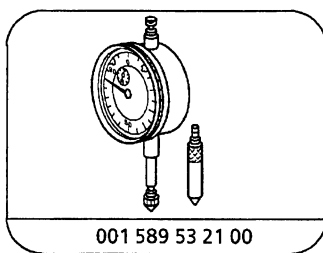

001 589 53 21 00

Dial gage

Commercially available tools (see Workshop Equipment Manual)

Number	Designation	Make (e. g.)	Order no.
WH58.30-Z-1009-12A	Quick calipers for internal measurements, Ø 100 - 120 mm		
WH58.30-Z-1027-12A	Micrometer 100 - 125 mm	Hahn and Kolb Borsigstr. 50 D-70469 Stuttgart	313346 100

ENGINE 904.905 /906 /907 /909 /910 /911 /915 /916 /917 /921 /922, 906.910 /911 /915 /916 /919 /920 /921 /922 /923 /925 /926 /927 /928 /939 /942 /943





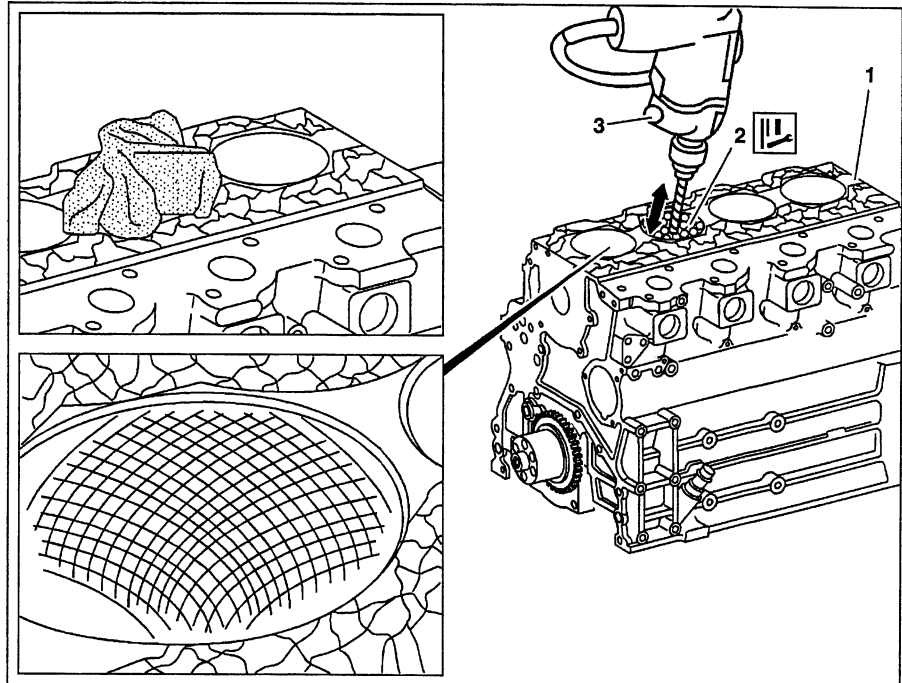

ENGINE 904.908 /923 in MODEL 668, 670

ENGINE 906.940 /941 /951 /952 in MODEL 957

- 1 Crankcase
 2  Honing brush
 3 Hand drill



W01.40-0001-06

	Machining		
1	Remove pistons		AR03.10-W-7021A
2	Measure cylinder bore		Page 84
3	Mask over openings and bores at the crankcase contact surface (1)		
4	Insert pieces of foam through the cylinder walls over the crankshaft and the bearings	<p> As a protection against grinding product residues. Do not use cleaning cloth because these do not adequately absorb grinding product residues and lubricants.</p>	
5	Insert hand drill (3) with honing brush (2) into the cylinder bore to be machined	<p> Honing brush  Use honing oil, thin-bodied engine oil, petroleum or diesel fuel. Place a protection or protective box onto the crankcase contact surface in order to prevent soiling the surrounding area and clothing.  Do not exceed a working speed of approx. 200 rpm (risk of honing brush snapping off).</p>	WH58.30-Z-1001-04A
6	Move honing brush (2) evenly up and down	<p> Change direction once about 1/4 of the honing brush is projecting at the top or bottom. Machining time approx. 1-2 min.</p>	
7	Inspect surface structure	<p> A grinding pattern of approx. 45° and a mat appearance should be aimed for. If the surface is glossy, ↓</p>	

		repeat machining.	
8	Remove pieces of foam and eliminate grinding product residues	 use a clean cloth.	
9	Remove masking on the crankcase contact surface (1)		
10	Clean cylinder walls with cleaning petroleum		
11	Install pistons		AR03.10-W-7021A

Commercially available tools (see Workshop Equipment Manual)

Number	Designation	Make (e. g.)	Order no.
WH58.30-Z-1001-04A	Honing brush (roughness 120)	Walter Krupp Göddertzgarten 53340 Meckenheim- Merl	

ENGINE 904.905 /906 /907 /909 /910 /911 /915 /916 /917 /921 /922, 906.910 /911 /915 /916 /919 /920 /921 /922 /923 /925 /926 /927 /928 /939 /942 /943

ENGINE 904.908 /923 in MODEL 668, 670

ENGINE 906.940 /941 /951 /952 in MODEL 957

ENGINE 904.941 in MODEL 684

1 Crankcase

A Reference height of crankcase

B Bore \varnothing of cylinder liner

C Bore \varnothing of cylinder liner collar

D Distance between cylinder liner collar seat and contact surface of crankshaft bearing cap

E Fillet radius of cylinder liner collar to cylinder liner collar seat

F Chamfer at cylinder liner collar seat

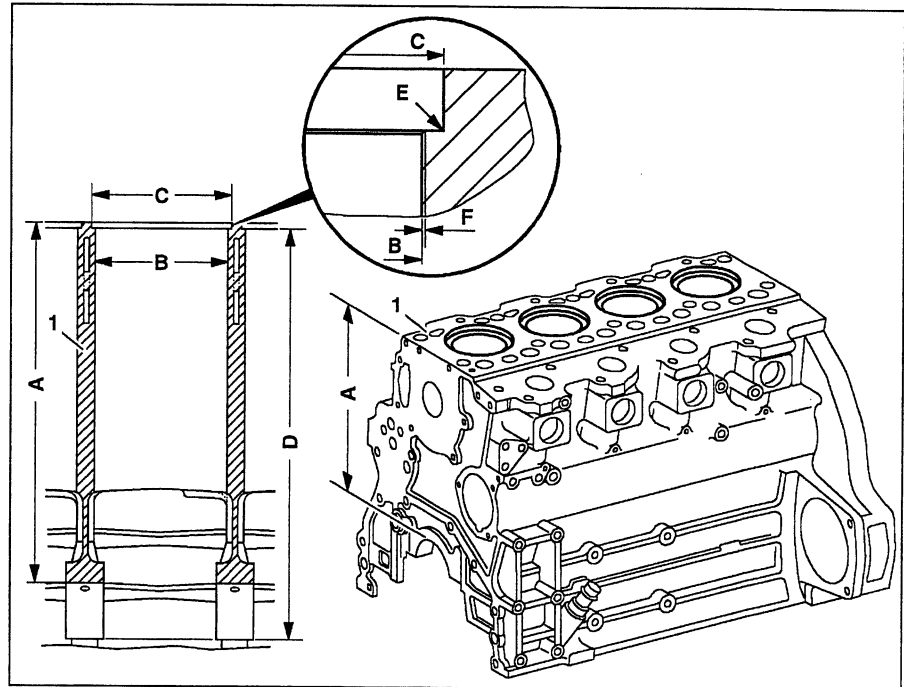

W01.40-0002-06

	Machining		
1	Clamp crankcase (1) onto the drilling tool		
2	Align cylinder wall to drilling tool	i With centering device above reversal point of first piston ring.	
3	Clamp drilling tool in place and widen cylinder bore in several operations	i If several cylinder liners are installed, pay attention to sequence of operations in order to avoid excessive thermal stresses. Engine 904; cylinder bore 2-4-1-3 Engine 906; cylinder bore 1-3-5-2-4-6 Widen to about 0.05 mm of the desired final dimension (cylinder liner bore \varnothing). i Settings of honing machine. Working pressure (p): 2.5-3.0 bar Speed (n): 60-100 rpm Honing angle (α): 40-60° Number of strokes: 30-40 Height of crankcase (A)	BE01.40-N-1006-02B
4	Widen cylinder bore to final dimension (finish-boring)	i Set boring tool to the relevant diameter by means of the measuring device. Bore \varnothing (B) Peak-to-valley height (R_z)	BE01.40-N-1007-02B BE01.40-N-1012-02B
5	Bore liner collar seat	i Use boring tool with 90° cutting angle. Bore \varnothing (C)	BE01.40-N-1008-02B

		Distance between cylinder liner collar seat in contact surface of crankshaft bearing cap (D)	BE01.40-N-1009-02B
		Contact surface of cylinder liner collar	BE01.40-N-1014-02B
		Roundness and peak-to-valley height of cylinder liner collar bore	BE01.40-N-1015-02B
		Overlap of cylinder liner to crankcase	BE01.40-N-1017-02B
		Fillet radius (E)	BE01.40-N-1018-02B
		Chamfer (F)	BE01.40-N-1019-02B
6	Deburr crankcase with polishing stone at the chamfer		

Inspection data of crankcase

Number	Designation		Engine 904.9, 906.9
BE01.40-N-1006-02B	Crankcase - height (A), measured from main bearing shell seat to contact surface of cylinder head	Standard	mm 298.35-298.50
		Undersize -0.3	mm 298.05-298.20
		Undersize -0.6	mm 297.75-297.90
		Undersize -0.9	mm 297.45-297.60
BE01.40-N-1007-02B	Bore \varnothing for cylinder liner in crankcase (B)	mm	106.000-106.035
BE01.40-N-1008-02B	Bore \varnothing for cylinder liner collar in crankcase (C)	mm	109.572-109.626
BE01.40-N-1009-02B	Distance between cylinder liner collar seat and contact surface of crankshaft bearing cap (D) in all installation stages	mm	338.900-339.100
BE01.40-N-1012-02B	Peak-to-valley height (R_z) of bored (honed) cylinder bore for installing cylinder liners	μm	25
BE01.40-N-1014-02B	Contact surface of cylinder liner collar in crankcase	Radial runout	mm 0.030
		Flatness	mm 0.010
		Peak-to-valley height (R_z)	μm 16
BE01.40-N-1015-02B	Bore for cylinder liner collar in crankcase	Roundness	mm 0.060
		Peak-to-valley height (R_z)	μm 25
BE01.40-N-1017-02B	Overlap of cylinder liner to machined crankcase	mm	≤ 0.040
BE01.40-N-1018-02B	Fillet radius of cylinder liner collar \varnothing to cylinder liner collar seat in crankcase (E)	mm	0.2
BE01.40-N-1019-02B	Chamfer at cylinder liner collar seat to cylinder bore (F)	mm	0.3-0.4
		\sphericalangle°	45

ENGINE 904.905 /906 /907 /909 /910 /911 /915 /916 /917 /921 /922, 906.910 /911 /915 /916 /919 /920 /921 /922 /923 /925 /926 /927 /928 /939 /942 /943

ENGINE 904.908 /923 in MODEL 668, 670

ENGINE 906.940 /941 /951 /952 in MODEL 957

- 1 Crankcase
2 Cylinder liner
3 Boring tool

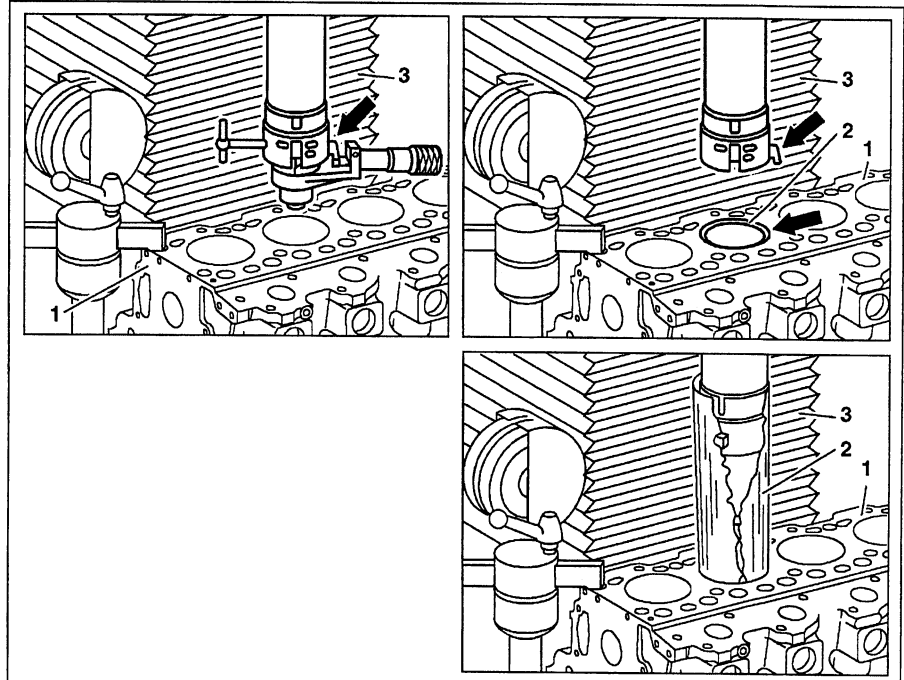

W01.40-0004-06

☐	Removing		
1	Remove crankshaft		AR03.20-W-4351A
2	Clamp crankcase (1) onto the boring tool (3)		
3	Align cylinder liner to boring tool (3)	<p>i With centering device above reversal point of first piston ring.</p>	
4	Clamp boring tool in place and widen cylinder liner (2) to half of the wall thickness in several operations	<p>i If several cylinder liners are removed, pay attention to sequence of operations in order to avoid excessive thermal stresses. Engine 904 cylinder bore 2-4-1-3 Engine 906 cylinder bore 1-3-5-2-4-6</p> <p>Cylinder liner outer Ø</p> <p>Cylinder liner inner Ø</p>	<p>BE01.40-N-1001-03B</p> <p>BE01.40-N-1001-02B</p>
5	Widen cylinder liner (2) to about 0.2 mm below the outer diameter	<p>i The liner collar is detached with this setting of the boring tool.</p>	BE01.40-N-1001-03B
6	Use a three-pointed file to score the cylinder liner (2) over its entire length	<p>i When this is done, the cylinder liner collapses</p> <p>⊗ Do not damage crankcase.</p>	

Inspection data of crankcase

Number	Designation	Engine 904.9, 906.9
BE01.40-N-1001-02B	Cylinder wall or cylinder liner inner Ø	Code letter A mm 101.985-101.991
		Code letter B mm 101.992-102.008
		Code letter C mm 102.009-102.015

Inspection data of cylinder liner

Number	Designation	Engine 904.9, 906.9
BE01.40-N-1001-03B	Cylinder liner outer Ø	mm 106.075-106.095

ENGINE 904.905 /906 /907 /909 /910 /911 /915 /916 /917 /921 /922, 906.910 /911 /915 /916 /919 /920 /921 /922 /923 /925 /926 /927 /928 /939 /942 /943

ENGINE 904.908 /923 in MODEL 668, 670

ENGINE 906.940 /941 /951 /952 in MODEL 957

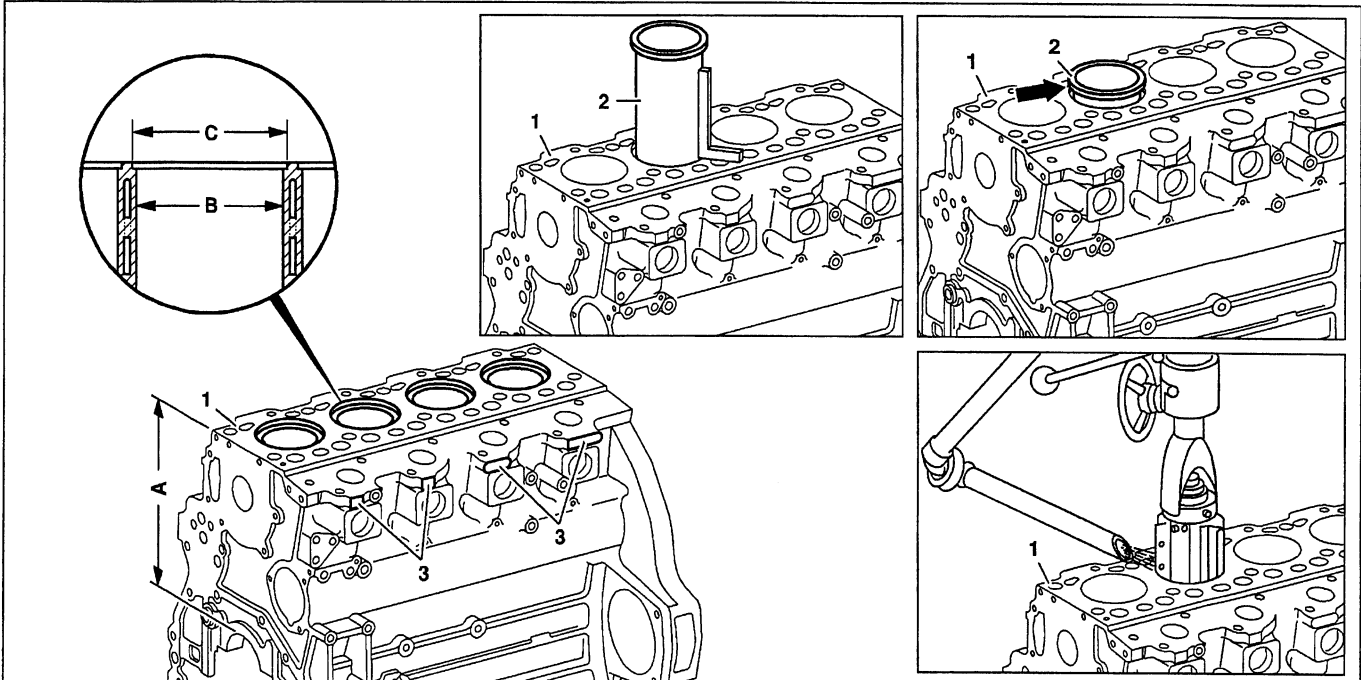

W01.40-0035-09

1 Crankcase

2 Cylinder liner









3 Marking areas on crankcase

A Crankcase height

B Bore diameter of cylinder liner

C Bore diameter of cylinder liner collar

	Installing		
1.1	Widen cylinder bore in crankcase (1)	Only if no cylinder liner (2) is installed.	Page 88
1.2	Remove cylinder liner (2)	Only if a cylinder liner (2) is installed.	Page 90
2	Measure bore and collar seat in crankcase (1)	Bore \varnothing (B) of cylinder liner Bore \varnothing (C) of cylinder liner collar	BE01.40-N-1007-02B BE01.40-N-1008-02B
3	Coat bore in crankcase (1) with acid-free grease.		BR00.45-Z-1018-06A
4	Measure cylinder liner (2)	Overlap Cylinder liner outer \varnothing Cylinder liner collar outer \varnothing	BE01.40-N-1017-02B BE01.40-N-1001-03B BE01.40-N-1002-03B
5	Place crankcase (1) onto the press and align	Workshop press	WE58.40-Z-1001-12A
6	Position cylinder liner (2) at the bore at right angles		
7	Press in cylinder liner (2) until it projects about 20 mm	Use a suitable plate for pressing in. Inspect collar seat for abrasion (arrow), clean with compressed air if necessary.	

8	Press in cylinder liner (2) into final position	 With approx. 3 t until it makes contact, then briefly relieve pressure and press into final position with approx. 7 t for a duration of approx. 5 s.	
9	Machine contact face of crankcase (1)	<p> Pay attention to undersize stages of crankcase height, height (A) measured from main bearing shell seat to contact surface of cylinder head</p> <p>Peak-to-valley height (R_z) of crankcase contact surface</p> <p>Crankcase - flatness of contact surface</p> <p>Crankcase - parallelism of contact surface, measured to main bearing shell seat</p>	<p>BE01.40-N-1006-02B</p> <p>BE01.40-N-1011-02B</p> <p>BE01.40-N-1013-02B</p> <p>BE01.40-N-1016-02B</p>
10	Clamp crankcase (1) onto the drilling tool		
11	Align cylinder wall to drilling tool	 With centering device above reversal point of first piston ring.	
12	Clamp boring tool in place and widen cylinder liner (2) in several operations	<p> If several cylinder liners are installed, pay attention to sequence of operations in order to avoid excessive thermal stresses.</p> <p>Engine 904 cylinder bore 2-4-1-3 Engine 906; cylinder bore 1-3-5-2-4-6</p> <p>Widen to about 0.05 mm of the desired final dimension (bore \varnothing of cylinder liner).</p> <p>Widen to about 0.05 mm of the desired final dimension (inner \varnothing of cylinder wall or cylinder liner).</p> <p> Settings of precision boring machine</p> <p>Speed (n): 250-280 rpm Infeed (f): 0.04-0.06 mm/U</p>	BE01.40-N-1001-02B
13	Hone cylinder liner to final dimension	<p>Cylinder liner inner \varnothing</p> <p>Variation of cylinder shape</p> <p>Peak-to-valley height (R_z) of cylinder liner</p> <p>Variation of cylinder wall or cylinder liner</p> <p> Settings of honing machine</p> <p>Working pressure (p): 2.5-3.0 bar Speed (n): 60-100 rpm Honing angle (α): 40-60 ° Number of strokes: 30-40</p>	<p>BE01.40-N-1001-02B</p> <p>BE01.40-N-1002-02B</p> <p>BE01.40-N-1004-02B</p> <p>BE01.40-N-1005-02B</p>
14	Gage adjacent walls and re-hone, if necessary	<p> Pressing in can result in changes to the microstructure which cause the inner \varnothing of the cylinder wall (cylinder shape) of the adjacent cylinders to alter slightly.</p> <p>Variation of cylinder shape</p>	<p>BE01.40-N-1001-02B</p> <p>BE01.40-N-1002-02B</p>
15	Clean crankcase (1)		
16	Correct markings on marking areas (3) on crankcase after machining	 Markings of classification	Page 95

Inspection data of crankcase

Number	Designation	Engine 904.9, 906.9
BE01.40-N-1001-02B	Cylinder wall or cylinder liner inner Ø	Code letter A mm 101.985-101.991
		Code letter B mm 101.992-102.008
		Code letter C mm 102.009-102.015
BE01.40-N-1002-02B	Cylinder wall - variation of cylinder shape	mm 0.012
BE01.40-N-1004-02B	Peak-to-valley height (R _z) of cylinder wall or cylinder liner	µm 2.5-4.5
BE01.40-N-1005-02B	Variation of cylinder wall or cylinder liner, measured perpendicular to crankshaft axis and to main bearing shell seat	mm ≤0.050
BE01.40-N-1006-02B	Crankcase - height (A), measured from main bearing shell seat to contact surface of cylinder head	Standard mm 298.35-298.50
		Undersize -0.3 mm 298.05-298.20
		Undersize -0.6 mm 297.75-297.90
		Undersize -0.9 mm 297.45-297.60
BE01.40-N-1007-02B	Bore Ø for cylinder liner in crankcase (B)	mm 106.000-106.035
BE01.40-N-1008-02B	Bore Ø for cylinder liner collar in crankcase (C)	mm 109.572-109.626
BE01.40-N-1011-02B	Peak-to-valley height (R _z) of crankcase contact surface	µm 8-16
BE01.40-N-1013-02B	Crankcase - flatness of contact surface	Over entire length mm 0.030
		Over a length of 150 mm in longitudinal and transverse direction mm 0.015
BE01.40-N-1016-02B	Crankcase - parallelism of contact surface, measured to main bearing shell seat	mm 0.05
BE01.40-N-1017-02B	Overlap of cylinder liner to machined crankcase	mm ≤0.040

Inspection data of cylinder liner

Number	Designation	Engine 904.9, 906.9
BE01.40-N-1001-03B	Cylinder liner outer Ø	mm 106.075-106.095
BE01.40-N-1002-03B	Cylinder liner collar outer Ø	mm 109.374-109.428

Repair products

Number	Designation	Order no.
BR00.45-Z-1018-06A	ATE grease	-

Workshop equipment/MB testers (see Workshop Equipment Manual)

WE58.40-Z-1001-12A	Stationary workshop press 65 t, e.g. Matra-Werke GmbH, D-60314 Frankfurt/Main
--------------------	---

AR01.40-W-9273-01A	Marking crankcase after machining		
--------------------	-----------------------------------	--	--

Inspection data of crankcase

Number	Designation	Engine 904.9, 906.9		
BE01.40-N-1001-02B	Cylinder wall or cylinder liner inner \varnothing	Code letter A	mm	101.985-101.991
		Code letter B	mm	101.992-102.008
		Code letter C	mm	102.009-102.015
BE01.40-N-1006-02B	Crankcase - height (A), measured from main bearing shell seat to contact surface of cylinder head	Standard	mm	298.35-298.50
		Undersize -0.3	mm	298.05-298.20
		Undersize -0.6	mm	297.75-297.90
		Undersize -0.9	mm	297.45-297.60

Markings (classification) of the cylinder bore \varnothing and crankcase height (dimension "A") are applied to the marking areas (I , II) on the crankcase in the area of the unit pump bores.

- Engine 904 with 3 marking areas (I) at cylinders 1 to 3 and 1 marking area (II) at cylinder 4.
- Engine 906 with 5 marking areas (I) at cylinders 1 to 5 and 1 marking area (II) at cylinder 6.

ⓘ Each time the crankcase is machined, the markings on the marking areas (I , II) of squares "1, 2, 6" must be corrected.

Explanation of marking:

Square "1": Classification of cylinder bore \varnothing with abbreviated designations "A"/"B"/"C".

- If the cylinder bore \varnothing differs, the appropriate code letter is entered in square "1" at all cylinders.
- If cylinder bore \varnothing is the same, the square "1" at the last cylinder is blank.

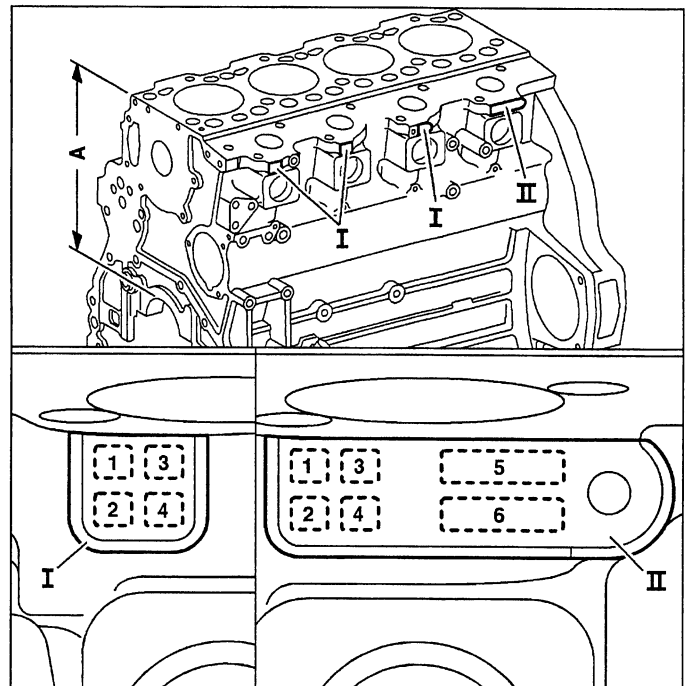

W01.40-0036-12

Square "2": At the last cylinder, classification of uniform cylinder bore \varnothing with abbreviated designations "A"/"B"/"C" (no marking in square "1" at last cylinder).

Square "3, 4, 5": Of no significance for repair sector (machining identifications of engine manufacturer).

Square "6": At last cylinder

- No marking indicates "standard crankcase height without cylinder liners".
- If "-.3"/"-.6"/"-.9" is entered in the square, this indicates a crankcase with a reduced crankcase height (undersize).
- If, in addition, "Z" is entered in the square, this indicates that cylinder liners are installed in the crankcase.

Example: Marking "-.3" indicates reduced crankcase height.
Marking "-.3 Z" indicates reduced crankcase height and cylinder liners installed.

ENGINE 904.905 /906 /907 /921



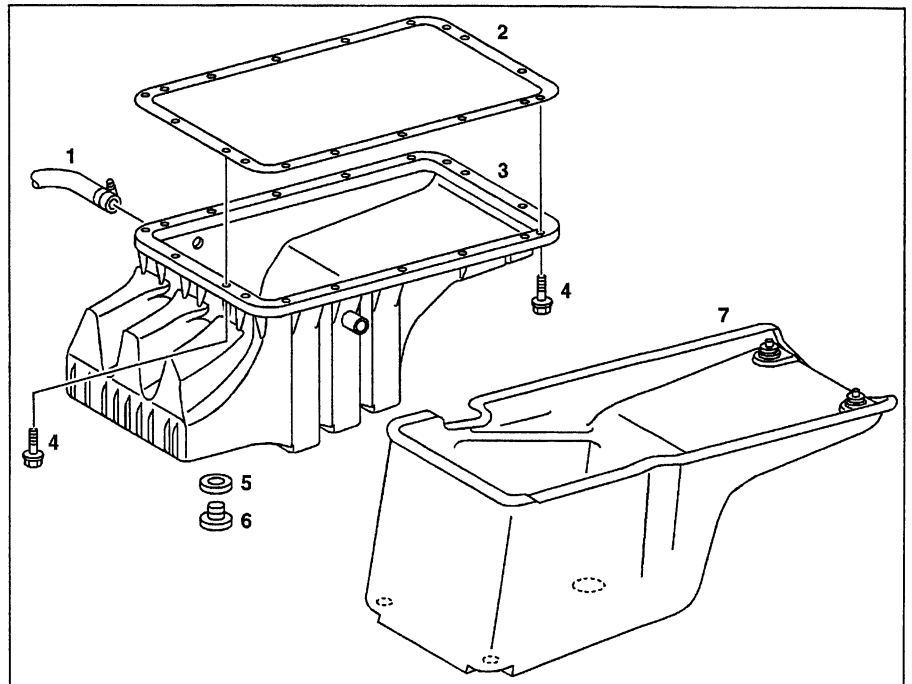



- 1 Oil filler line
- 2 Gasket
- 3 Oil pan
- 4 Bolt
- 5 Seal
- 6 Oil drain plug
- 7 Noise encapsulation



W01.45-0004-06

Modification notes

7.7.98	Pay attention to installation position of shortened bolt at oil pan (as of engine end no. 004 313 up to engine end no. 004 449).	Step 4	
	Tightening torque of oil drain plug modified	Step 4	

	Removing, installing		
1	Remove noise encapsulation (7) at oil pan	 Installation: Quick-locks must engage.	
2	Extract or drain engine oil		WH0101.40
3	Detach oil filler line (1) at oil pan		
4	Take off oil pan (3)	<p> Installation: Clean oil pan and contact surface at crankcase. Replace gasket (2), pay attention to installation position.</p> <p> as of engine end no. 004 313 up to engine end no. 004 449 a shortened bolt (2) was fitted. Pay attention to installation position at rear left of oil pan (compressor side).</p> <p> Bolt of oil pan to crankcase</p> <p> Installation: Replace seal (5).</p> <p> Oil drain plug</p>	<p>BA01.45-N-1001-01B</p> <p>BA01.45-N-1002-01B</p>
5	Install in the reverse order		
6	Check engine oil level with dipstick		WH0101.40

7	<p>⚠ Danger!</p> <p>Risk of accident from vehicle starting off by itself when engine running. Risk of injury from bruises and burns if you insert your hand into the engine when it is started or when it is running.</p> <p>Start engine and observe oil pressure gage at idle speed</p>	<p>Secure vehicle to prevent it starting off by itself.</p> <p>Wear closed and close-fitting work clothes. Do not grasp hot or rotating parts.</p>	<p>Page 33</p> <p>BE18.00-N-1001-01C</p>
		<p>ⓘ Start engine with starter for max. 90 seconds. Wait about 2 minutes before repeating start operation.</p> <p>Motor nicht hochdrehen solange noch kein Öldruck angezeigt wird.</p> <p>ⓘ The oil pressure gage must indicate oil pressure after about 10 seconds.</p>	
8	Switch off engine and inspect for leaks		

Test data of engine oil pressure

Number	Designation	Engine 904.9, 906.9	
		Idle speed	bar
BE18.00-N-1001-01C	Engine oil pressure at	bar	≥ 0.5
		Maximum speed	bar

Nm Oil pan

Number	Designation	Engine 904.9, 906.9	
		Nm	
BA01.45-N-1001-01B	Bolt of oil pan to crankcase	Nm	25
BA01.45-N-1002-01B	Oil drain plug to oil pan	M 20x1.5	Nm 65
		M 26x1.5	Nm 85

ENGINE 904.909 /910 /911 /915 /916 /917 /922, 906.910 /911 /915 /916 /919 /920 /921 /922 /923 /925 /926 /927 /928 /939 /942 /943

- 1 Oil pan
- 2 Gasket
- 3 Bolt
- 4 Oil filler line
- 5 Seal
- 6 Oil drain plug
- 7 Electric engine wiring harness

B14 Engine oil level sensor

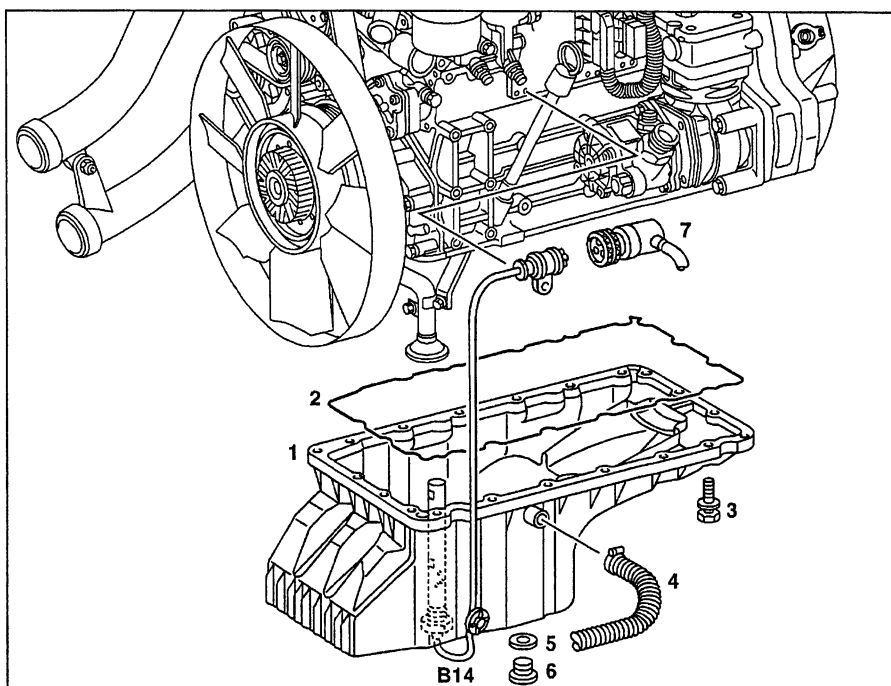

W01.45-0005-06

	Removing, installing		
1	Extract or drain engine oil		AP18.00-W-0101B
2	Detach oil filler line (4) at oil pan		
3	Separate electric cable of engine oil level sensor (B14) at engine wiring harness (7)		
4	Detach transmission oil lines at fixtures and tie up	Transmission 715.5 Do not separate transmission oil lines.	
5	Take off oil pan (1)	Clean oil pan and contact surface at crankcase. Installation: Replace gasket (2), pay attention to installation position. 	BA01.45-N-1001-01B
		Installation: Replace seal (5). Oil drain plug	BA01.45-N-1002-01B
6	Install in the reverse order		
7	Inspect engine oil level at the electric gage	Model 950 - 957	AP18.00-W-0101-07A
Danger!	Risk of accident from vehicle starting off by itself when engine running. Risk of injury from bruises and burns if you hold your hand into engine when it is started or when it is running.	Secure vehicle to prevent it moving off by itself. Wear closed and close-fitting work clothes. Do not grasp hot or rotating parts.	Page 33

8	Start engine and observe oil pressure gage at idle speed	<p>ⓘ Start engine with the starter for not more than 90 s. Wait about 2 min. before repeating start operation. Do not rev up engine so long as no oil pressure is indicated.</p> <p>ⓘ The oil pressure gage must indicate oil pressure after about 10 s.</p>	BE18.00-N-1001-01C
9	Switch off engine and inspect for leaks		

Test data of engine oil pressure

Number	Designation	Engine 904.9, 906.9
BE18.00-N-1001-01C	Engine oil pressure at	
	Idle speed	bar ≥ 0.5
	Maximum speed	bar ≥ 2.5

Nm Oil pan

Number	Designation	Engine 904.9, 906.9
BA01.45-N-1001-01B	Bolt of oil pan to crankcase	Nm 25
BA01.45-N-1002-01B	Oil drain plug to oil pan	M 20x1.5 Nm 65
		M 26x1.5 Nm 85

ENGINE 904.905 /906 /907 /909 /910 /911 /915 /916 /917 /921 /922, 906.910 /911 /915 /916 /920 /921 /922 /923 /925 /926 /927 /928 /939 /942 /943

ENGINE 904.908 /923 in MODEL 668, 670

ENGINE 906.940 /941 /951 /952 in MODEL 957

- 1 Bolt
- 2 Timing case
- 3 Shear bolt (only with adjustable crankshaft angle position sensor)
- 4 Bracket (only with adjustable crankshaft angle position sensor)
- 5 Dowel pins
- 6 Gasket
- 7 Bolt
- 8 Oil pan
- 9 Radial seal
- 10 Flywheel

B15 Crankshaft angle position sensor



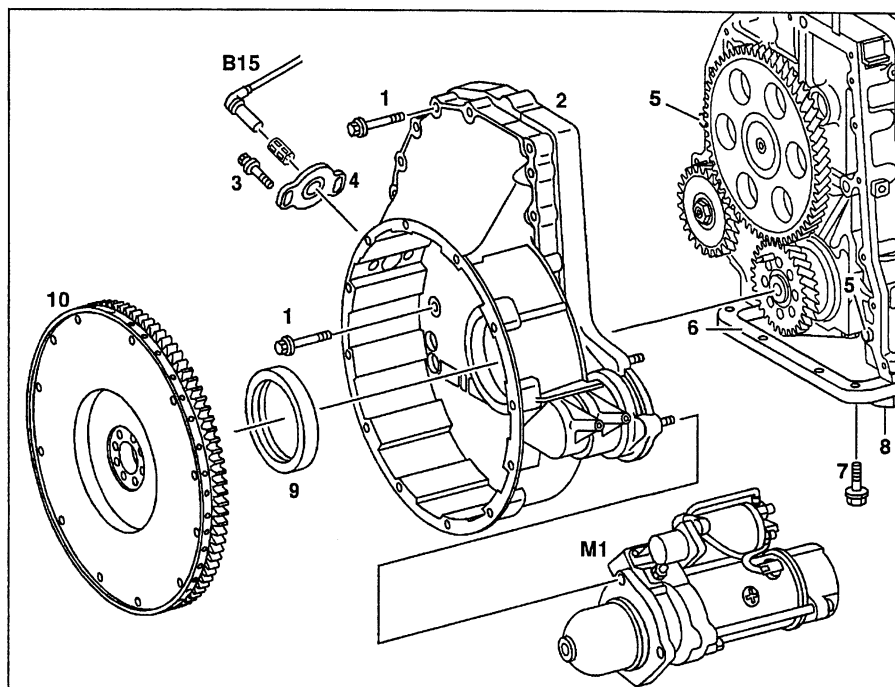

M1 Starter







W01.60-0006-06

Modification notes

24.6.98	Pay attention to installation position of shortened bolt at oil pan (as of engine end no. 004 313 up to engine end no. 004 449).	Step 5	
---------	--	--------	--

	Removing, installing		
1	Remove starter (M1)	Engine 904.905- 907/909- 911/915- 917/921/922, Engine 906.910/911/915/916/919- 923/925- 928/939/940/941/942/943/951/952 Engine 904.908/923	AR15.30-W-7100A AR15.30-D-7100D
2	Remove flywheel (10)		AR03.30-W-8002A
3	Take off attached parts at timing case (2)		
4	Pull out crankshaft angle position sensor (B15)	 Installation: Press in crankshaft angle position sensor as far as the stop.	
5	Unscrew bolts (7) at oil pan (8) in the area of the timing case (2)	 as of engine end no. 004 313 up to engine end no. 004 449 a bolt (7) was shortened, pay attention to installation position at rear left of oil pan (compressor side). 	BA01.45-N-1001-01B
6	Slacken the remaining bolts (7) at the oil pan (8) and lower oil pan (8)	 Do not damage oil pan gasket, if necessary ↓ Remove oil pan and replace oil pan gasket. Engine 904.905- 907/921	Page 97

		Engine 904.908/923 Engine 909-911/915-917/922, Engine 906.910/911/915/916/919-923/925- 928/939/940/941/942/943/951/952	AR01.45-D-7500D Page 99
7	Take off timing case (2)	 Cover over opening at oil pan. Inspect timing case for damage, if necessary ↓ Replace timing case and fit on all existing attached parts.  	BA01.60-N-1001-01A BA01.60-N-1002-01A BR00.45-Z-1010-01A
8	Remove, install, set bracket of crank shaft angle position sensor.	 Only in the case of timing cases with adjustable bracket (4)	AR07.15-W-1640B
9	Replace radial seal ring (9).	 Replace radial seal only when timing case (2) installed as installation dimension is related to the crankshaft.	AR03.20-W-3063A
10	Install in the reverse order		

 Timing case

Number	Designation	Engine 904.9, 906.9
BA01.60-N-1001-01A	Bolt of timing case to crankcase	Nm 50
BA01.60-N-1002-01A	End cover of inspection hole to timing case	Nm 25

 Oil pan

Number	Designation	Engine 904.9, 906.9
BA01.45-N-1001-01B	Bolt of oil pan to crankcase	Nm 25

Repair products

Number	Designation	Order no.
BR00.45-Z-1010-01A	Loctite 574 sealant	001 989 89 20

ENGINE 906.920 /921 /922 /923 /925 /926 /927 /928



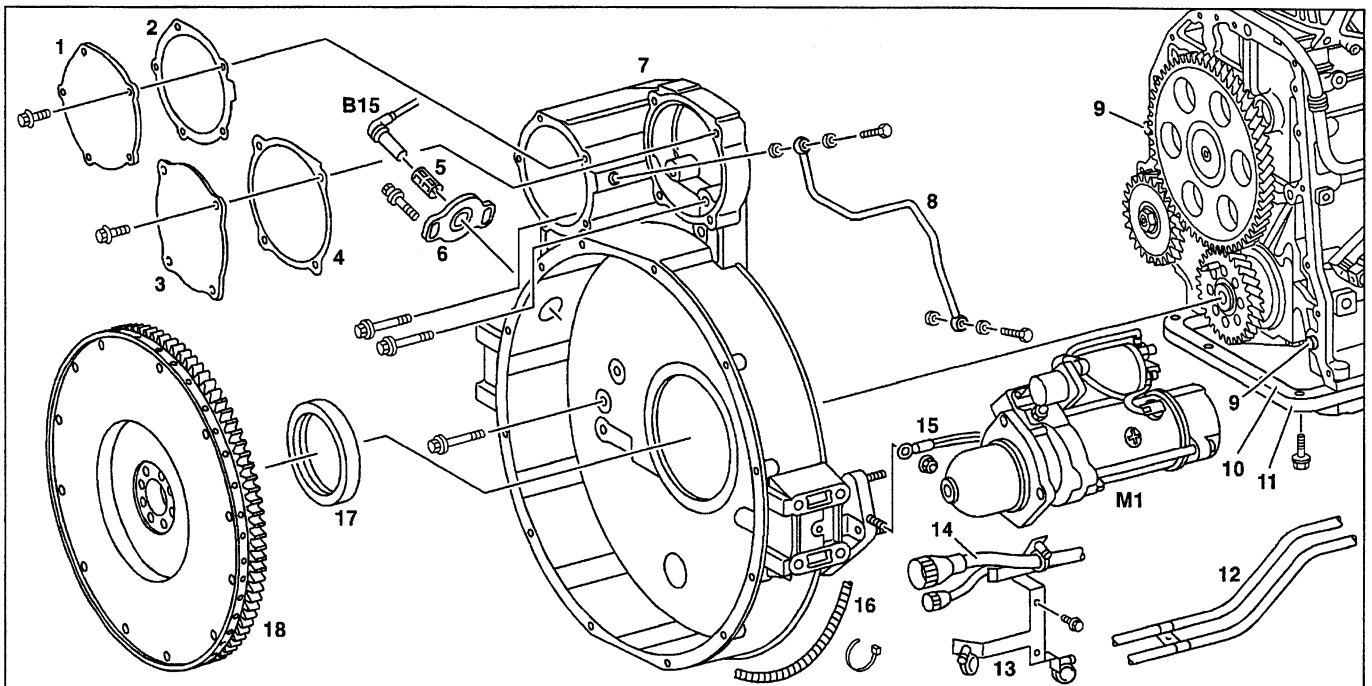





timing case SAE 1 or 2, readied for engine output or installed engine output



W01.60-1001-09

- | | | | |
|----|---|-----|---|
| 1 | End cover | 11 | Oil pan |
| 2 | Gasket | 12 | Transmission oil line |
| 3 | End cover | 13 | Bracket |
| 4 | Gasket | 14 | Wiring harness (transmission and retarder)) |
| 5 | Clamping bush | 15 | Ground cable |
| 6 | Bracket (only with adjustable crankshaft angle position sensor) | 16 | Wiring harness |
| 7 | Timing case | 17 | Radial seal |
| 8 | Oil line (rear engine output) | 18 | Flywheel |
| 9 | Dowel pin | | |
| 10 | Gasket | | |
| | | B15 | Crankshaft angle position sensor |
| | | M1 | Starter |

	Removing, installing		
1	Remove starter (M1)		AR15.30-W-7100A
2	Remove flywheel (18)		AR03.30-W-8002A
3	Take off end cover (3) together with gasket (4) at timing case (7)		
4	Take off end cover (1) together with gasket (2) at timing case (7)		
5	Remove oil line (8)	Only if rear engine output fitted.	
6	Take off bracket (13) together with wiring harness (14) at timing case (7)		
7	Detach transmission oil lines (12) at timing case (7) and at crankcase		
8	Detach ground cable (15), wiring harness (16) and attached parts at timing case (7)		

9	Pull out crankshaft angle position sensor (B15) and detach cables at timing case (7)	 Installation: Press in clamping bush (5) and crankshaft angle position sensor as far as the stop.	
10	Unscrew bolts at the oil pan (11) in the area of the timing case (7)		BA01.45-N-1001-01B
11	Slacken the remaining bolts at the oil pan (11) and lower oil pan	 Do not damage oil pan gasket (10), if necessary: ↓ Remove oil pan and replace oil pan gasket.	Page 99
12	Take off timing case (7)	 Cover over opening at oil pan. Inspect timing case for damage, if necessary ↓ Replace timing case and fit on all existing attached parts.  	BR00.45-Z-1010-01A BA01.60-N-1001-01A BA01.60-N-1002-01A
13	Remove, install, set bracket of crank shaft angle position sensor	 Only in the case of timing cases with adjustable bracket (6).	AR07.15-W-1640B
14	Replace radial seal ring (17).	 Replace radial seal only when timing case (7) installed.	AR03.20-W-3063A
15	Install in the reverse order		

 Oil pan

Number	Designation	Engine 904.9, 906.9
BA01.45-N-1001-01B	Bolt of oil pan to crankcase	Nm 25

 Timing case

Number	Designation	Engine 904.9, 906.9
BA01.60-N-1001-01A	Bolt of timing case to crankcase	Nm 50
BA01.60-N-1002-01A	End cover of inspection hole to timing case	Nm 25

Repair products

Number	Designation	Order no.
BR00.45-Z-1010-01A	Loctite 574 sealant	001 989 89 20

Part 2

ENGINE 904.905 /906 /907 /909 /910 /911 /915 /916 /917 /921 /922, 906.910 /911 /915 /916 /919 /920 /921 /922 /923 /925 /926 /927 /928 /939 /942 /943

ENGINE 904.908 /923 in MODEL 668, 670

ENGINE 906.940 /941 /951 /952 in MODEL 957

- 1 Pistons
- 2 Piston pin
- 3 Circlip
- 4 Connecting rods
- 5 Conrod bearing cap
- 6 Conrod bolt
- 7 Conrod bearing shell

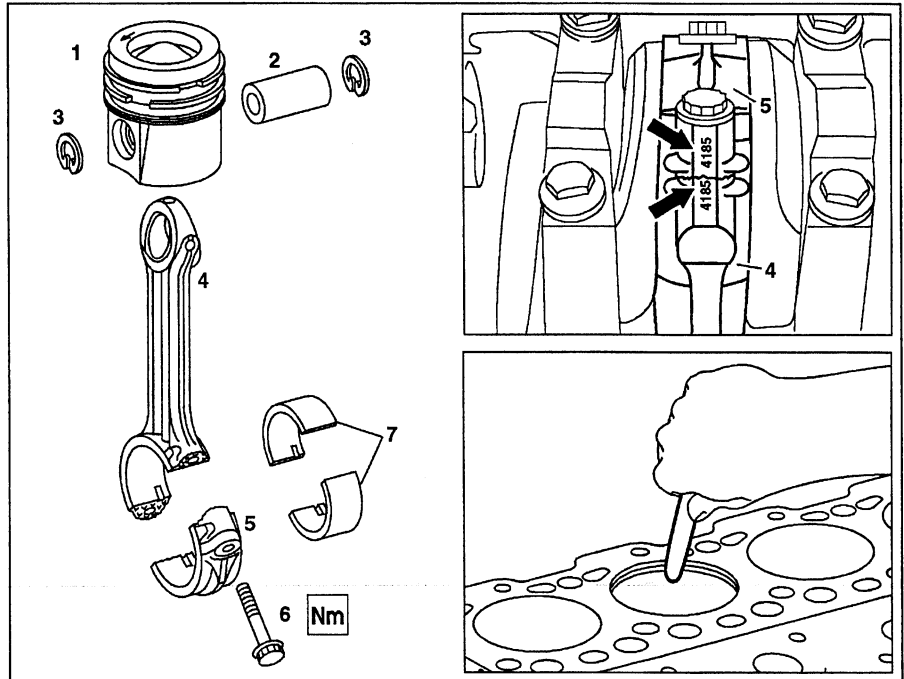

W03.10-0005-06

- 1 Pistons
- 2 Piston pin
- 4 Connecting rods
- 5 Conrod bearing cap
- 7 Conrod bearing shell
- 8 Oil spray nozzle

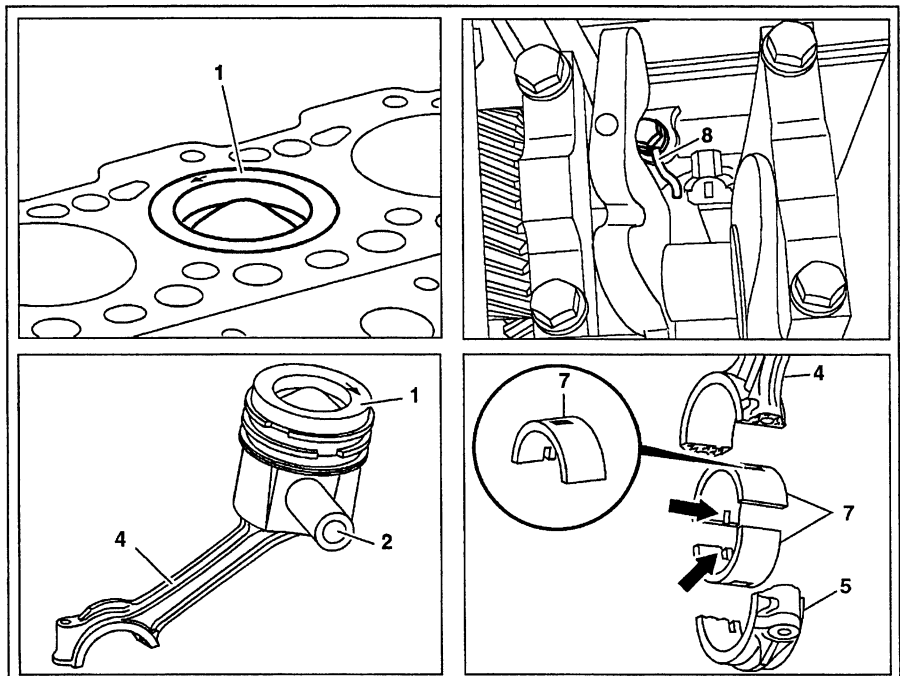





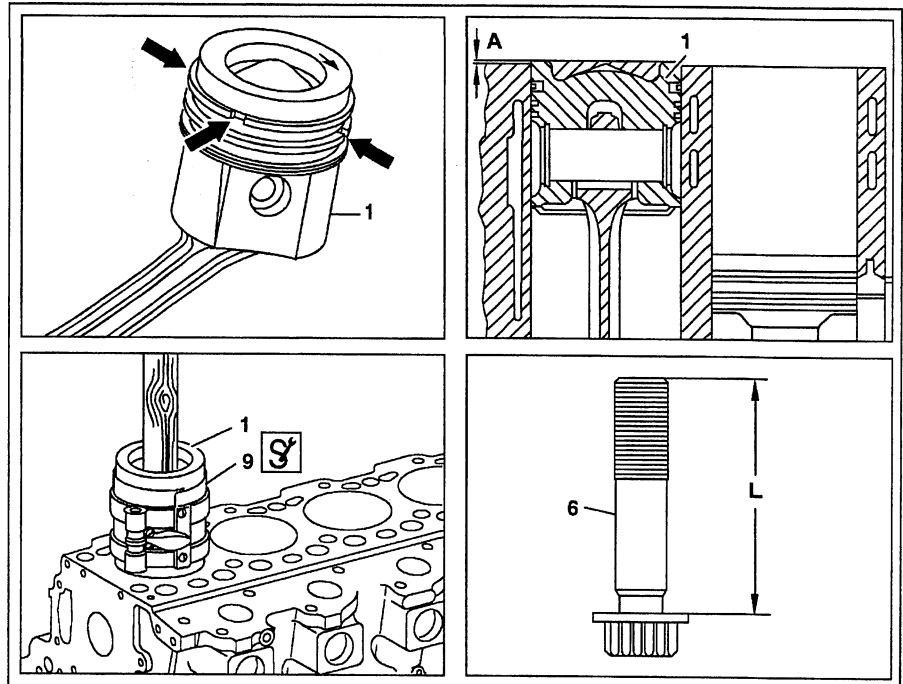



















W03.10-0006-06





- 1 Pistons
- 6 Conrod bolt shank length (L)
- 9  Tensioning strap
- A Piston projection



W03.10-0007-06

	Removing		
1	Remove cylinder head	Engine 904.905- 907/909- 911/915- 917/ 921/922, 906.910/911/915/916/919- 923/ 925- 928/939/940/941/942/943/951/952 Engine 904.908/923	AR01.30-W-5800A AR01.30-D-5800D
2	Remove oil pan	Engine 904.905- 907/921 Engine 904.908/923 Engine 904.909- 911/915- 917/922, 906.910/911/915/916/919- 923/925- 928/ 939/940/941/942/943/951/952	AR01.45-W-7500A AR01.45-D-7500D AR01.45-W-7500C
3	Use a scraper to carefully remove combustion residues above the top land zone in the cylinder wall	 This ensures the piston rings are not damaged when the pistons are removed.	
4	Remove conrod bearing cap (5)	 Mark conrod bearing cap and conrod to each other.  Do not damage cracked contact surface. If damage is present ↓ replace connecting rod.	
5	Remove piston (1) together with conrod (4) from the crankcase	 Use a wooden or plastic handle. If the cracked contact surface is damaged, replace conrod.  If the direction arrow on the piston is no longer visible, make direction arrow (pointing in opposite direction of power output).  Do not damage oil spray nozzle (8) ↓ Replace damaged oil spray nozzle. In the case of screwed oil spray nozzle In the case of interference-fit oil spray nozzle	AR18.00-W-4000A AR18.00-W-4000C

6	Mark conrod bearing shells (7) to the conrod bearing cap (5) and conrod (4) and remove	 Engines have different conrod bearing shells in conrod bearing cap and conrod.	
7	Remove piston pin (2) and take out conrod (4)	 Clamp conrod together with piston. Use soft protective jaws.	
8	Measure conrod bolts (6)	 If the max. shank length (L) is exceeded ↓ replace conrod bolt.	BE03.10-N-1014-01B
	Inspecting		
9	Inspect piston stem and cylinder walls for wear		
	Notes for assessing wear to cylinder wall in the case of dust damage	Engine 904, 906, 541, 542	Page 9
	Notes for assessing wear of pistons in the case of dust damage	Engine 541, 542, 904, 906	Page 9
10	Inspect piston rings for spalling of coating	 Replace damaged piston rings.	Page 13
11	Inspect piston crown for damage	 Replace damaged pistons.	
12	Assign piston to cylinder bore	 Markings are stamped on piston crown.  If the crankcase has been machined, ↓ install new pistons with a lower compression height. Piston Ø group marking Piston compression height	Page 10 BE03.10-N-1001-02B BE03.10-N-1002-02B
13	Inspect conrods (4, 5) and conrod bearing (7), measure		Page 15
	Installing		
14	Assemble piston (1) and conrod (4)	 Oil piston pin and press in by hand.	
15	Oil piston (1) and position position piston ring gaps (arrows) offset 120°		
16	Guide tension strap (9) loosely over the piston rings and pull tight to the outer diameter of the piston (1)	  It must still just be possible to move the cup seal of the tensioning strap.	000 589 38 31 00
17	Insert conrod bearing shell (7) into conrod (4) and oil contact surface	 Pay attention to marking. The lug on the conrod bearing shell must be located in the slot of the conrod. The engines have different conrod bearing shells in conrod bearing cap and conrod. Pay attention to abbreviated part number on the rear of the conrod bearing shell halves.	
18	Introduce piston (1) into the crankcase until the tensioning strap (9) is touching the crankcase	 Direction arrow on piston crown must be facing forward (in opposite direction of power output) and the cracked contact surface at the conrod (4) is pointing toward the camshaft or unit pump.  Turn piston slightly when inserting so that the conrod does not damage the oil spray nozzle (8) during installation ↓ Replace damaged oil spray nozzle: ↓ Screwed oil spray nozzle	AR18.00-W-4000A

		Interference-fit oil spray nozzle	AR18.00-W-4000C
19	Press piston (1) into the crankcase	 Until conrod bearing shell (7) is resting against conrod journal of crankshaft.	
20	Fit conrod (4) and conrod bearing cap (5) onto the crankshaft		BA03.10-N-1001-01B
21	Rotate crankshaft and inspect clearance		BE03.10-N-1003-01B
22	Measure piston projection at all pistons	<p>Piston projection at TDC to top edge of crankcase</p>   <p> If the specified dimensions for piston projection are not maintained, ↓ inspect conrod and pistons</p>	<p style="text-align: right;">Page 11</p> <p>BE03.10-N-1003-02B</p> <p>001 589 53 21 00</p> <p>541 589 01 21 00</p>
23	Installing oil pan	<p>Engine 904.905- 907/921</p> <p>Engine 904.908/923</p> <p>Engine 904.909- 911/915- 917/922</p> <p>Engine 906.910/911/915/916/919- 923/925- 928/939/940/941/942/943/951/952</p>	<p>AR01.45-W-7500A</p> <p>AR01.45-D-7500D</p> <p>AR01.45-W-7500C</p>
24	Install cylinder head	<p>Engine 904.905- 907/909- 911/915- 917/921/922,</p> <p>Engine 906.910/911/915/916/919- 923/925- 928/939/940/941/942/943/951/952</p> <p>Engine 904.908/923</p>	<p>AR01.30-W-5800A</p> <p>AR01.30-D-5800D</p>

Inspection data of connecting rod

Number	Designation			Engine 904.905/ 906/907, engine 904.909/ 910/911/921/922, 906.910/911/919/ 920/921/922/ 923/940/941 up to end no. 119308	Engine 904.908/923
BE03.10-N-1001-01B	Conrod bearing inner Ø with conrod bearing shells inserted	Standard	mm	70.054-70.093	70.054-70.093
		Undersize 0.1	mm	69.954-69.993	69.954-69.933
		Undersize 0.25	mm	69.804-69.843	69.804-69.843
		Undersize 0.5	mm	69.554-69.593	69.554-69.593
		Undersize 0.75	mm	69.304-69.343	69.304-69.343
		Undersize 1.0	mm	69.054-69.093	69.054-69.093
BE03.10-N-1003-01B	Conrod bearing play	radial	mm	0.039-0.098	0.039-0.098
		axial	mm	0.170-0.470	0.170-0.470
BE03.10-N-1014-01B	Conrod bolt	Thread Ø	M	12×1.25	12×1.25
		Shank length (L) when new	mm	56.0	56.0
		Shank length (L)	mm	≤ 57.0	≤ 57.0

Inspection data of connecting rod

Number	Designation			Engine 904.909/ 910/911/921/922, 906.910/911/919/ 920/921/922/ 923/940/941 as of end no. 119309, 904.915/916/917, 906.915/916/925/ 926/927/928/ 939/951/952
BE03.10-N-1001-01B	Conrod bearing inner \varnothing with conrod bearing shells inserted	Standard	mm	70.054-70.093
		Undersize 0.1	mm	69.954-69.993
		Undersize 0.25	mm	69.804-69.843
		Undersize 0.5	mm	69.554-69.593
		Undersize 0.75	mm	69.304-69.343
		Undersize 1.0	mm	69.054-69.093
BE03.10-N-1002-01B	Basic bore \varnothing for conrod bearing		mm	75.000-75.019
BE03.10-N-1014-01B	Conrod bolt	Thread \varnothing	M	12 \times 1.25
		Shank length (L) when new	mm	56.0
		Shank length (L)	mm	\leq 57.0

Test dimensions for pistons

Number	Designation			Engine 904.905/ 906/907 engine 904.909/ 910/911/921/922, 906.910/911/919/ 920/921/922/923 /940/941 up to end no. 119308	Engine 904.908/923	
BE03.10-N-1001-02B	Piston \varnothing	Group marking	BA	mm	101.781-101.790	101.781-101.790
			BC	mm	101.790-101.799	101.790-101.799
BE03.10-N-1002-02B	Piston compression height	Standard	102 BA	mm	64.36-64.40	64.36-64.40
			102 BC	mm	64.36-64.40	64.36-64.40
		Undersize I	102 BA-0.3	mm	64.06-64.10	64.06-64.10
			102 BC-0.3	mm	64.06-64.10	64.06-64.10
		Undersize II	102 BA-0.6	mm	63.76-63.80	63.76-63.80
			102 BC-0.6	mm	63.76-63.80	63.76-63.80
		Undersize III	102 BA-0.9	mm	63.46-63.50	63.46-63.50
			102 BC-0.9	mm	63.46-63.50	63.46-63.50
BE03.10-N-1003-02B	Piston projection at TDC to top edge of crankcase		mm	0.28-0.50	0.28-0.50	

Test dimensions for pistons

Number	Designation	Engine 904.909/ 910/911/921/922, 906.910/911/919/ 920/921/922/ 923/940/941 as of end no. 119308 Engine 904.915/ 916/917, 906.915/916/925/ 926/927/928/ 939/951/952			
BE03.10-N-1001-02B	Piston \varnothing	Group marking	BA	mm	101.781-101.790
			BC	mm	101.790-101.799
BE03.10-N-1002-02B	Piston compression height	Standard	102 BA	mm	64.36-64.40
			102 BC	mm	64.36-64.40
		Undersize I	102 BA-0.3	mm	64.06-64.10
			102 BC-0.3	mm	64.06-64.10
		Undersize II	102 BA-0.6	mm	63.76-63.80
			102 BC-0.6	mm	63.76-63.80
Undersize III	102 BA-0.9	mm	63.46-63.50		
	102 BC-0.9	mm	63.46-63.50		
BE03.10-N-1003-02B	Piston projection at TDC to top edge of crankcase		mm	0.28-0.50	
BE03.10-N-1004-02B	Piston pin bore		mm	42.003-42.009	
BE03.10-N-1005-02B	Piston pin \varnothing		mm	41.995-42.000	

 Connecting rod

Number	Designation	Engine 904.9, 906.9		
BA03.10-N-1001-01B	Bolt of conrod bearing cap to conrod	1st stage	Nm	10
		2nd stage	Nm	45
		3rd stage	Δ°	90

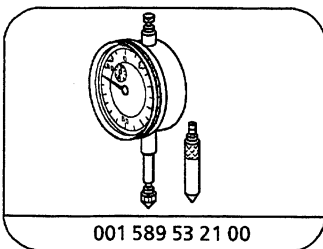

Dial gage

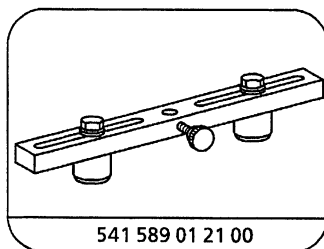

Measuring bridge

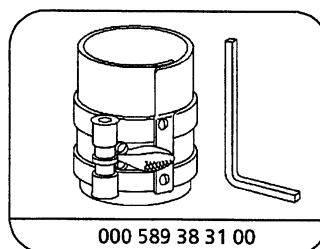

Tensioning strap

AH01.40-N-0001-01A	Notes for assessing wear of cylinder wall if dust damage present	Engine 904, 906, 541, 542	i
--------------------	--	---------------------------	----------

Cylinder walls or cylinder liners without dust damage

The honing is more or less clearly recognizable over the entire contact surface. The honing may be partially worn off at the reversal point of the first piston ring.

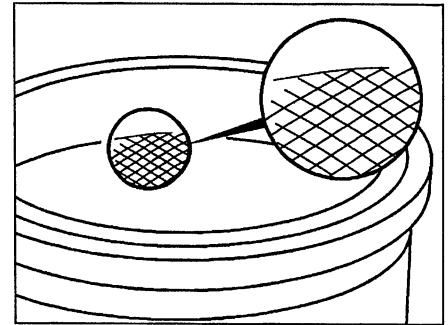

W03.10-0014-01

Cylinder walls or cylinder liners with dust damage

The traces of machining from honing are only still weakly visible or not at all. If wear is at an advanced stage, a wear step can be felt at the reversal point of the first piston ring.



Dust damage is caused by poor seal, splits or chafing of the inlet lines, seals and hoses. When carrying out maintenance and repair work, inspect all the inlet lines, seals and hoses carefully, even at points which are not easily accessible.

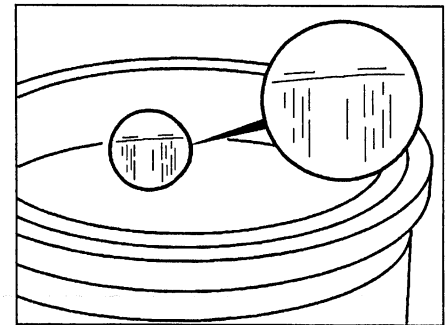

W03.10-0015-01

AH03.10-N-0001-01A	Notes for assessing wear to pistons in the case of dust damage	Engine 541, 542, 904, 906	i
--------------------	--	---------------------------	----------

Pistons without dust damage

The contact surface of the piston stem is visible over a large area and the machining grooves can still be recognized within this area.



The machining grooves at the circumference are intentional recesses which are filled with oil and contribute to better lubrication.

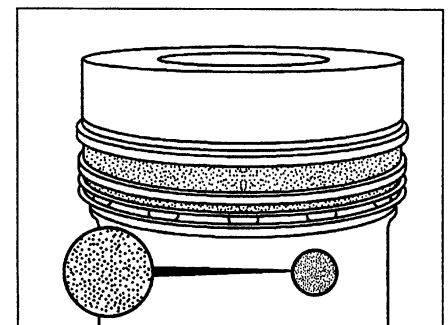

W03.10-0012-01

Pistons with dust damage

The contact pattern at the stem has a mat (pumiced) appearance and the machining grooves are completely worn away within the contact surface. In the advanced stage of wear, slight traces of seizure are already present on the stem and the piston rings are sharp-edged.

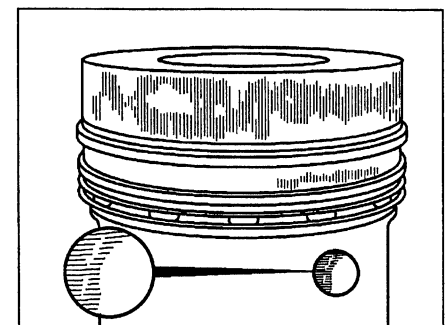

W03.10-0013-01

AR03.10-W-7021-03A	Assigning pistons to cylinder bore		
--------------------	------------------------------------	--	--

Test dimensions for pistons

Number	Designation				Engine 904.905/ 906/907 Engine 904.909/ 910/911/921/922, 906.910/911/919/ 920/921/922/923 /940-943 up to end no. 119308	Engine 904.908/923
BE03.10-N-1001-02B	Piston Ø	Group marking	BA	mm	101.781-101.790	101.781-101.790
			BC	mm	101.790-101.799	101.790-101.799
BE03.10-N-1002-02B	Piston compression height	Standard	102 BA	mm	64.36-64.40	64.36-64.40
			102 BC	mm	64.36-64.40	64.36-64.40
		Undersize I	102 BA-0.3	mm	64.06-64.10	64.06-64.10
			102 BC-0.3	mm	64.06-64.10	64.06-64.10
		Undersize II	102 BA-0.6	mm	63.76-63.80	63.76-63.80
			102 BC-0.6	mm	63.76-63.80	63.76-63.80
		Undersize III	102 BA-0.9	mm	63.46-63.50	63.46-63.50
			102 BC-0.9	mm	63.46-63.50	63.46-63.50

Test dimensions for pistons

Number	Designation				Engine 904.909/ 910/911/921/922, 906.910/911/919/ 920/921/922/ 923/940-943 as of end no. 119308 Engine 904.915/ 916/917, 906.915/916/925/ 926/927/928/ 939/951/952
BE03.10-N-1001-02B	Piston Ø	Group marking	BA	mm	101.781-101.790
			BC	mm	101.790-101.799
BE03.10-N-1002-02B	Piston compression height	Standard	102 BA	mm	64.36-64.40
			102 BC	mm	64.36-64.40
		Undersize I	102 BA-0.3	mm	64.06-64.10
			102 BC-0.3	mm	64.06-64.10
		Undersize II	102 BA-0.6	mm	63.76-63.80
			102 BC-0.6	mm	63.76-63.80
		Undersize III	102 BA-0.9	mm	63.46-63.50
			102 BC-0.9	mm	63.46-63.50
BE03.10-N-1003-02B	Piston projection at TDC to top edge of crankcase		mm	0.28-0.50	

Tolerance group marking on piston

Assign piston (refer to arrow for piston \varnothing marking and compression height marking) to the relevant cylinder bore \varnothing and crankcase height.

Piston \varnothing → Cylinder bore \varnothing
 BA → A or B
 BC → B or C

Piston \varnothing and Compression height → crankcase housing height

BA or BC → Standard
 BA -0.3 or BC -0.3 → o-/u-size -0.3
 BA -0.6 or BC -0.6 → o-/u-size -0.6
 BA -0.9 or BC -0.9 → o-/u-size -0.9

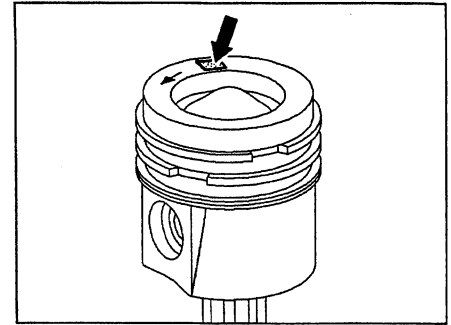

W03.10-0034-01

AR03.10-W-7041-01A	Measuring piston projection		
--------------------	-----------------------------	--	--

Test dimensions for pistons

Number	Designation	mm	Engine 904.905/ 906/907/909/ 910/911/921/922, 906.910/911/919/ 920/921/922/ 923/940/941	Engine 904.908/923
BE03.10-N-1003-02B	Piston projection at TDC to top edge of crankcase	mm	0.28-0.50	0.28-0.50

Test dimensions for pistons

Number	Designation	mm	Engine 904.915/916/917, 906.915/916/925/ 926/927/928/ 939/951/952
BE03.10-N-1003-02B	Piston projection at TDC to top edge of crankcase	mm	0.28-0.50

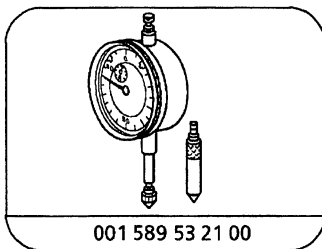

001 589 53 21 00

Dial gage

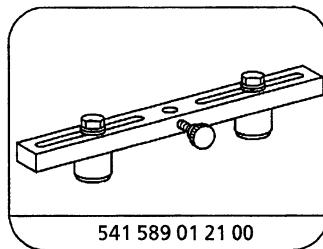

541 589 01 21 00

Measuring bridge

i Measure projection between piston crown and crankcase contact surface without cylinder head gasket fitted. The measurement must be carried out in the direction of the piston pin in order to eliminate the piston rock.

- 1 Rotate crankshaft until the piston to be measured is positioned at approx. 5 mm before TDC.
- 2 Attach dial gage (1) with a preload in the measuring bridge (2).
- 3 Mount measuring bridge (2) onto the contact surface of the crankcase (arrows) and set scale of dial gage to "0".
- 4 Move measuring bridge (2) from the crankcase contact surface over the cylinder bore.
i Pull back tracer pin at dial gage (1) when moving measuring bridge.
- 5 Rotate crankshaft until the piston to be measured is positioned at TDC.
- 6 Tracer pin of dial gage (1) is pushed back with the piston crown. The measurement indicated is the piston projection.

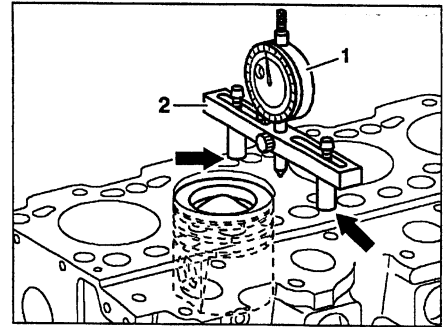

W03.10-0031-01

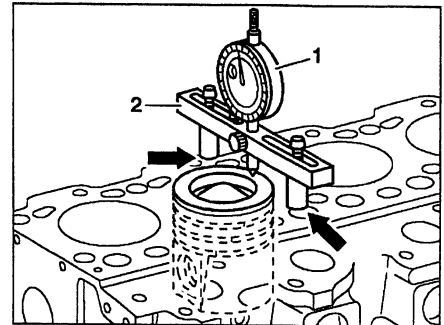



W03.10-0009-01

ENGINE 904.905 /906 /907 /909 /910 /911 /915 /916 /917 /921 /922, 906.910 /911 /915 /916 /919 /920 /921 /922 /923 /925 /926 /927 /928 /939 /942 /943





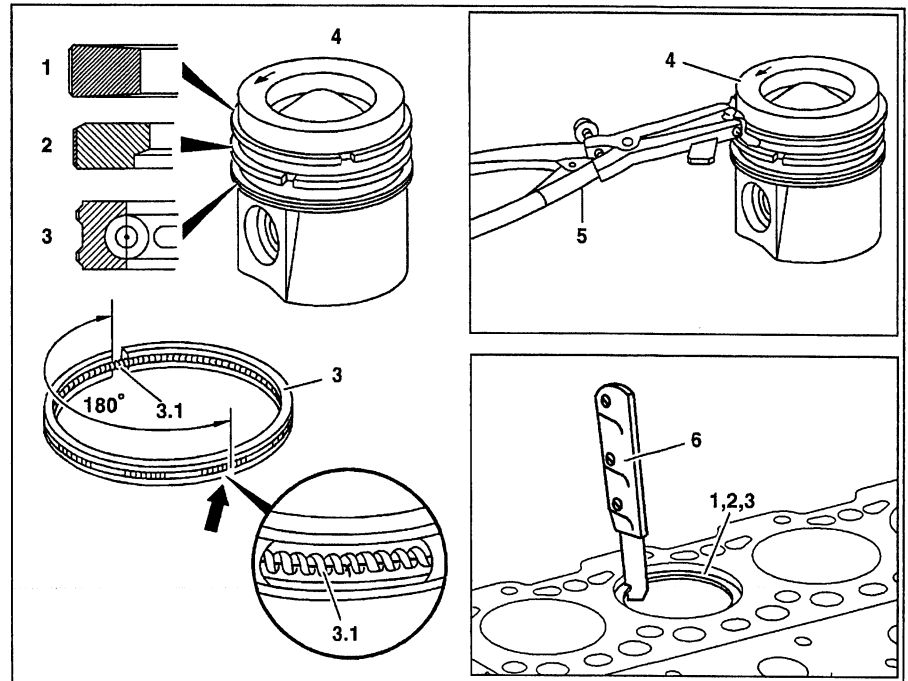

ENGINE 904.908 /923 in MODEL 668, 670

ENGINE 906.940 /941 /951 /952 in MODEL 957

- 1 Piston ring keystone ring (groove I)
- 2 Piston ring taper faced compression ring with inner angle (groove II)
- 3 Piston ring slotted oil control ring with coil spring (groove III)
- 3.1 Coil spring
- 4 Pistons
- 5  Pliers
- 6  Feeler gage



W03.10-0032-06

	Removing, installing		
1	Remove pistons (4)		Page 3
2	Remove piston rings (1, 2, 3) in the order from top to bottom	<p> Installation: Marking "TOP" must point toward piston crown. The piston rings must be inspected visually for spalling of the coating before being re-installed and after being installed, if necessary ↓</p> <p>Replace piston rings</p> <p></p>	000 589 37 37 00
3	Measure piston ring gap clearance of piston rings (1, 2)	<p>Insert piston rings in the unworn area (above the reversal point of the 1st piston ring) of the cylinder wall or cylinder liner, and measure gap clearance.</p> <p></p>	BE03.10-N-1001-05B WH58.30-Z-1008-12A
4	Measure piston ring gap clearance of piston ring (3)	<p>Remove coil spring (3.1) from the piston ring.</p> <p>Insert piston ring in the unworn area (above the reversal point of the 1st piston ring) of the cylinder wall or cylinder liner, and measure gap clearance.</p> <p></p> <p> Installation: Install coil spring (3.1) into the piston ring. Coil spring joint must be offset 180° to the piston ring joint.</p>	BE03.10-N-1001-05B WH58.30-Z-1008-12A

5	Install in the reverse order		
---	------------------------------	--	--

Inspection data of piston rings

Number	Designation	Engine 904.9, 906.9		
BE03.10-N-1001-05B	Piston ring gap clearance	Groove I	when new	mm $\leq 0.35-0.55$
		Keystone ring	Wear limit	mm ≤ 1.0
	Taper faced compression ring with inner angle	Groove II	when new	mm $0 \leq .40-0.60$
			Wear limit	mm $1 \leq .0$
	Slotted oil control ring with coil spring	Groove III	when new	mm $\leq 0.25-0.50$
			Wear limit	mm ≤ 1.0

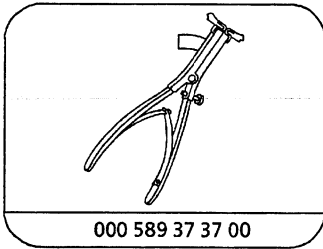

Pliers

Commercially available tools (see Workshop Equipment Manual)

Number	Designation	Make (e. g.)	Order no.
WH58.30-Z-1008-12A	Feeler gauge	Stiefelmayer D-73734 Esslingen	59

ENGINE 904.905 /906 /907 /908 /909 /910 /911 /915 /916 /917 /921 /922 /923, 906.910 /911 /915 /916 /919 /920 /921 /922 /923 /925 /926 /927 /928 /939 /940 /941 /942 /943 /951 /952

- 1 Connecting rods
- 2 Conrod bearing cap
- 3 Conrod bearing shell
- 4 Conrod bolt
- 5 Conrod bush

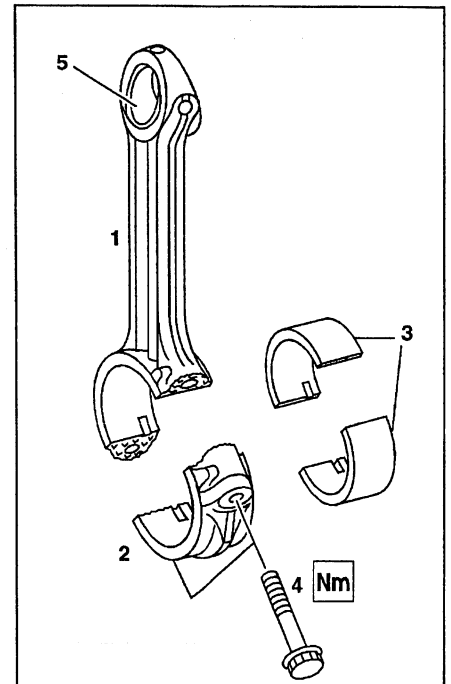

W03.10-0001-03

- 1 Connecting rods
- 3 Conrod bearing shells
- 5 Conrod bush
- 6 Dial gage
- 7 Dial gage holder

- A Distance from conrod bearing bore to conrod bush bore
- B Permissible variation of axial parallelism between conrod bearing bore and conrod bush bore related to distance measured
- C Distance measured

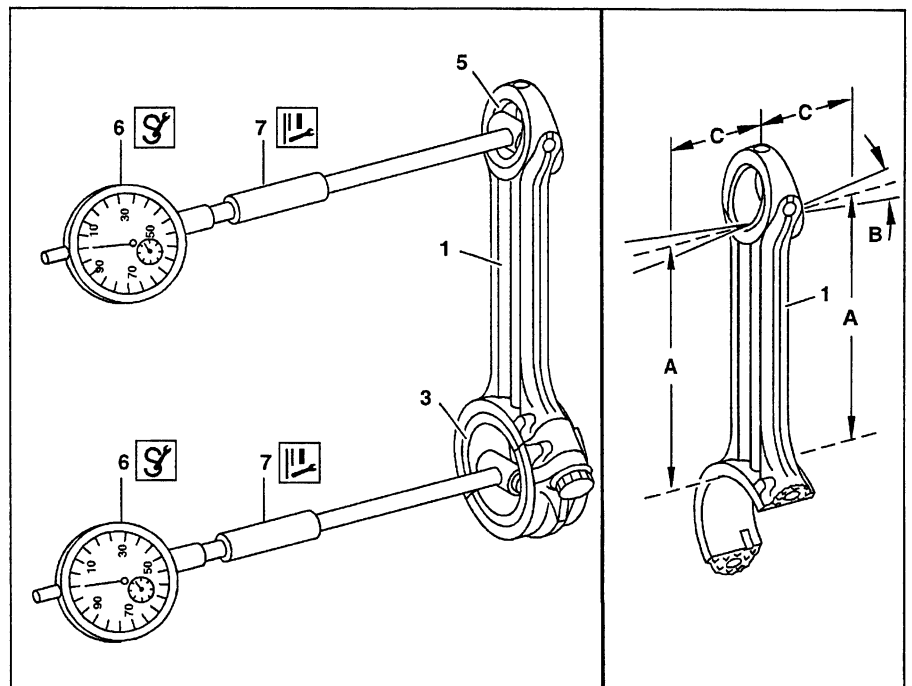













W03.10-0030-06

Modification notes

24.2.00	Notes on assessing wear to conrod bearings added	Step 2	Page 19
---------	--	--------	---------

	Removing		
1	Remove pistons		Page 3
	Inspecting		

2	Inspect conrod bearings for wear  Notes for assessing wear to conrod bearings	 Conrods with blue discoloration caused by a bearing damage, must not be re-used. Engine 541, 542, 904, 906	Page 19
3	Inspect inner diameter of conrod bush (5)	   If the specified value was exceeded ↓ replace connecting rod.	001 589 53 21 00 WH58.30-Z-1004-12A BE03.10-N-1012-01B
4	Inspect conrod (1) for distortion and dimensional tolerance	 Measure distance (dimension A) from conrod bearing seat to conrod bush inner diameter on both sides. If the specified measurement was exceeded ↓ replace connecting rod. Measure permissible variation (dimension B) of axial parallelism between conrod bearing seat and conrod bush inner diameter to measure distance (dimension C). If the specified measurement was exceeded ↓ replace connecting rod.  Conrod must not be straightened.	WH58.30-Z-1023-12A BE03.10-N-1015-01B BE03.10-N-1004-01B
5	Install conrod bearing shells (3), gage	 Engines have different conrod bearing shells in conrod bearing cap and conrod. Pay attention to abbreviated part number on the rear of the conrod bearing shell halves. Conrod bearing inner Ø Basic bore Ø Conrod bearing radial play Permissible out-of-roundness of basic bores Conrod bolt shank length (L) Conrod bearing journal Ø    	Page 21 BE03.10-N-1001-01B BE03.10-N-1002-01B BE03.10-N-1003-01B BE03.10-N-1006-01B BE03.10-N-1014-01B BE03.20-N-1004-02B BA03.10-N-1001-01B 001 589 53 21 00 WH58.30-Z-1006-12A WH58.30-Z-1009-12A
6	Determine conrod bearing axial play	Conrod bearing axial play Conrod width Conrod bearing journal width	BE03.10-N-1003-01B BE03.10-N-1008-01B BE03.20-N-1005-02B
	Installing		
7	Install pistons		Page 3

Inspection data of connecting rod

Number	Designation		Engine 904.905/ 906/907, engine 904.909/ 910/911/921/922, 906.910/911/919/ 920/921/922/ 923/940/941 up to end no. 119308	Engine 904.908/923	
BE03.10-N-1001-01B	Conrod bearing inner \varnothing with conrod bearing shells inserted	Standard	mm	70.054-70.093	70.054-70.093
		Undersize 0.1	mm	69.954-69.993	69.954-69.933
		Undersize 0.25	mm	69.804-69.843	69.804-69.843
		Undersize 0.5	mm	69.554-69.593	69.554-69.593
		Undersize 0.75	mm	69.304-69.343	69.304-69.343
		Undersize 1.0	mm	69.054-69.093	69.054-69.093
BE03.10-N-1002-01B	Basic bore \varnothing for conrod bearing		mm	75.000-75.019	75.000-75.019
BE03.10-N-1003-01B	Conrod bearing play	radial	mm	0.039-0.098	0.039-0.098
		axial	mm	0.170-0.470	0.170-0.470
BE03.10-N-1004-01B	Permissible variation of axial parallelism between conrod bearing bore and conrod bush bore over a length of 50 mm		mm	≤ 0.025	≤ 0.025
BE03.10-N-1006-01B	Permissible out-of-roundness of basic bores	Conrod bearing	mm	0.008	0.008
		Conrod bush	mm	0.006	0.006
BE03.10-N-1008-01B	Conrod width		mm	-	-
BE03.10-N-1012-01B	Conrod bush inner \varnothing		mm	40.03-40.04	40.03-40.04
BE03.10-N-1014-01B	Conrod bolt	Thread \varnothing	M	12 \times 1.25	12 \times 1.25
		Shank length (L) when new	mm	56.0	56.0
		Shank length (L)	mm	≤ 57.0	≤ 57.0
BE03.10-N-1015-01B	Distance from conrod bearing seat to conrod bush inner diameter		mm	157.510-157.445	157.510-157.445
		See figure		-	-

Inspection data of connecting rod

Number	Designation	Engine 904.909/ 910/911/921/922, 906.910/911/919/ 920/921/922/ 923/940/941 as of end no. 119309, 904.915/916/917, 906.915/916/925/ 926/927/928/ 939/951/952
BE03.10-N-1001-01B	Conrod bearing inner \varnothing with conrod bearing shells inserted	Standard mm 70.054-70.093
		Undersize 0.1 mm 69.954-69.993
		Undersize 0.25 mm 69.804-69.843
		Undersize 0.5 mm 69.554-69.593
		Undersize 0.75 mm 69.304-69.343
		Undersize 1.0 mm 69.054-69.093
BE03.10-N-1002-01B	Basic bore \varnothing for conrod bearing	mm 75.000-75.019
BE03.10-N-1003-01B	Conrod bearing play	radial mm 0.039-0.098
		axial mm 0.170-0.470
BE03.10-N-1004-01B	Permissible variation of axial parallelism between conrod bearing bore and conrod bush bore over a length of 50 mm	mm ≤ 0.025
BE03.10-N-1006-01B	Permissible out-of-roundness of basic bores	Conrod bearing mm 0.008
		Conrod bush mm 0.006
BE03.10-N-1008-01B	Conrod width	mm -
BE03.10-N-1012-01B	Conrod bush inner \varnothing	mm 42.03-42.04
BE03.10-N-1013-01B	Conrod bush in conrod overlap	mm 0.045-0.100
BE03.10-N-1014-01B	Conrod bolt	Thread \varnothing M 12 \times 1.25
		Shank length (L) when new mm 56.0
		Shank length (L) mm ≤ 57.0
BE03.10-N-1015-01B	Distance from conrod bearing seat to conrod bush inner diameter	mm 156.510-156.445
		See figure -

Crankshaft test data

Number	Designation	Engine 904.9	Engine 906.9
BE03.20-N-1004-02B	Conrod bearing journal \varnothing	Standard mm 69.995-70.015	69.995-70.015
		Undersize -0.1 mm 69.895-69.915	69.895-69.910
		Undersize -0.25 mm 69.745-69.765	69.745-69.765
		Undersize -0.5 mm 69.495-69.515	69.495-69.515
		Undersize -0.75 mm 69.245-69.265	69.245-69.265
		Undersize -0.1 mm 68.995-69.015	68.995-69.015
BE03.20-N-1005-02B	Conrod bearing journal width	mm 34.0-34.2	34.0-34.2

Nm Connecting rod

Number	Designation	Engine 904.9, 906.9		
BA03.10-N-1001-01B	Bolt of conrod bearing cap to conrod	1st stage	Nm	10
		2nd stage	Nm	45
		3rd stage	°	90

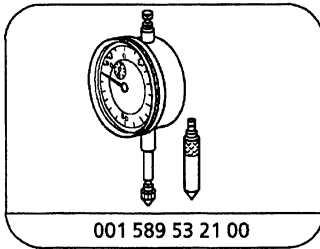

001 589 53 21 00

Dial gage

Commercially available tools (see Workshop Equipment Manual)

Number	Designation	Make (e. g.)	Order no.
WH58.30-Z-1004-12A	Quick calipers for internal measurements, Ø 40 - 60 mm		
WH58.30-Z-1006-12A	Micrometer 50 - 75 mm	Hahn and Kolb Borsigstr. 50 D-70469 Stuttgart	31 400 005
WH58.30-Z-1009-12A	Quick calipers for internal measurements, Ø 100 - 120 mm		
WH58.30-Z-1023-12A	Caliper gage with round scale	Hahn and Kolb Borsigstr. 50 D-70469 Stuttgart	31 165

AH03.10-N-0001-03A	Notes on assessing wear of conrod bearings and conrod bearing journals	Engine 541, 542, 904, 906	i
--------------------	--	---------------------------	----------

Assessing wear of conrod bearings

Conrod bearings without damage

The bearing shell is uniformly smooth over the entire bearing surface and without any visible scores and wear to the surface layer.

i The damage patterns presented below are only an extract of possible types of damage to conrod bearings. When assessing the types of damage, it is always necessary to include the surface finish of the conrod bearing journal (waviness, roughness) in the damage diagnosis.

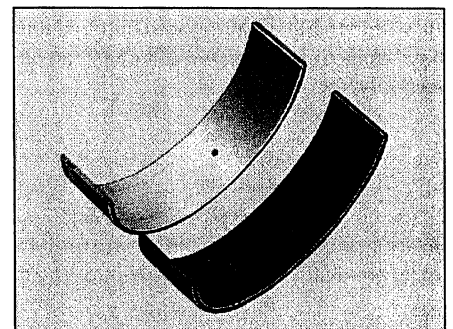

W03.10-1001-01

Slight scores and scratches around the circumference of the conrod bearing

Scores and scratches are slightly visible and perceptible on the surface of the bearing.

i Caused by fine dirt particles in oil circuit. Individual dirt scores and scratches are not critical. The bearing can still be re-used provided the preload of the bearings is still within the tolerance; gage conrod bearings for this purpose. When carrying out maintenance and repair work, inspect the oil in the oil filter, and also the engine oil, if necessary, for soiling.

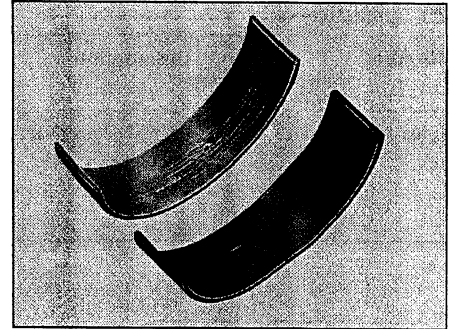

W03.10-1002-01

Severe scoring around circumference of conrod bearing

Scores are clearly visible and perceptible on the surface of the bearing.

i Caused by dirt and foreign particles in the oil circuit, e.g. as a result of a faulty oil filter, use of grinding agents as well as inadequate cleaning when carrying out engine repairs. The bearing can no longer be used and must be replaced.

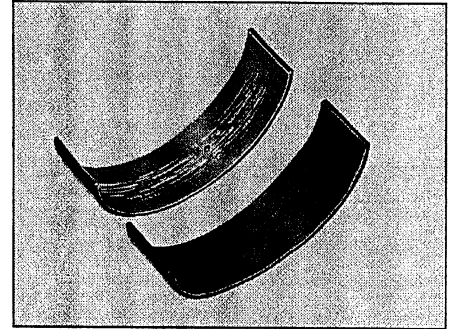

W03.10-1003-01

Assessing wear of conrod bearing journals at the crankshaft

Conrod bearing journals without damage

The surface of the bearing journal is uniformly smooth over the entire surface and has no visible scores.

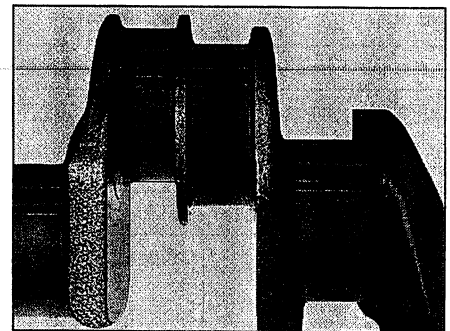

W03.20-1010-01

Slight scores and scratches around the circumference of the conrod bearing journal

Scores and scratches are slightly visible and perceptible on the surface.

i Caused by fine dirt particles in oil circuit. Individual dirt scores and scratches are not critical. The crankshaft can still be re-used provided the conrod bearing journal diameter is still within the tolerance; gage conrod bearing journal for this purpose. When carrying out maintenance and repair work, inspect the oil in the oil filter, and also the engine oil, if necessary, for soiling.

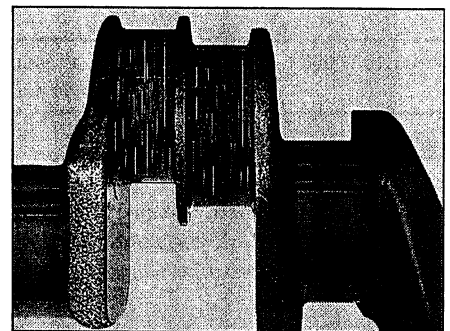

W03.20-1011-01

Severe scoring around circumference of conrod bearing journal

Scores are clearly visible and perceptible on the surface.

i Caused by dirt and foreign particles in the oil circuit, e.g. as a result of a faulty oil filter, use of grinding agents as well as inadequate cleaning when carrying out engine repairs. Measure the crankshaft and machine to the next oversize, if necessary. If reworking is no longer possible, the crankshaft must be replaced.

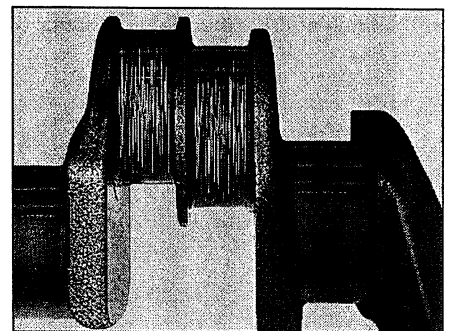

W03.20-1012-01

AR03.10-W-6111-06A	Installing, gaging conrod bearings		
--------------------	------------------------------------	--	--

Inspection data of connecting rod

Number	Designation		Engine 904.905/ 906/907, Engine 904.909/ 910/911/921/922, 906.910/911/919/ 920/921/922/ 923/940-943 up to end no. 119308	Engine 904.908/923	
BE03.10-N-1001-01B	Conrod bearing inner \varnothing with conrod bearing shells inserted	Standard	mm	70.054-70.093	70.054-70.093
		Undersize 0.1	mm	69.954-69.993	69.954-69.933
		Undersize 0.25	mm	69.804-69.843	69.804-69.843
		Undersize 0.5	mm	69.554-69.593	69.554-69.593
		Undersize 0.75	mm	69.304-69.343	69.304-69.343
		Undersize 1.0	mm	69.054-69.093	69.054-69.093
BE03.10-N-1002-01B	Basic bore \varnothing for conrod bearing		mm	75.000-75.019	75.000-75.019
BE03.10-N-1003-01B	Conrod bearing play	radial	mm	0.039-0.098	0.039-0.098
		axial	mm	0.170-0.470	0.170-0.470
BE03.10-N-1006-01B	Permissible out-of-roundness of basic bores	Conrod bearing	mm	0.008	0.008
		Conrod bush	mm	0.006	0.006
BE03.10-N-1014-01B	Conrod bolt	Thread \varnothing	M	12 \times 1.25	12 \times 1.25
		Shank length (L) when new	mm	56.0	56.0
		Shank length (L)	mm	\leq 57.0	\leq 57.0

Inspection data of connecting rod

Number	Designation		Engine 904.909/ 910/911/921/922, 906.910/911/919/ 920/921/922/ 923/940-943 as of end no. 119309, 904.915/916/917, 906.915/916/925/ 926/927/928/ 939/951/952	
BE03.10-N-1001-01B	Conrod bearing inner \varnothing with conrod bearing shells inserted	Standard	mm	70.054-70.093
		Undersize 0.1	mm	69.954-69.993
		Undersize 0.25	mm	69.804-69.843
		Undersize 0.5	mm	69.554-69.593
		Undersize 0.75	mm	69.304-69.343
		Undersize 1.0	mm	69.054-69.093
BE03.10-N-1002-01B	Basic bore \varnothing for conrod bearing		mm	75.000-75.019
BE03.10-N-1003-01B	Conrod bearing play	radial	mm	0.039-0.098
		axial	mm	0.170-0.470

Inspection data of connecting rod

Number	Designation	Engine 904.909/ 910/911/921/922, 906.910/911/919/ 920/921/922/ 923/940-943 as of end no. 119309, 904.915/916/917, 906.915/916/925/ 926/927/928/ 939/951/952		
BE03.10-N-1006-01B	Permissible out-of-roundness of basic bores	Conrod bearing	mm	0.008
		Conrod bush	mm	0.006
BE03.10-N-1014-01B	Conrod bolt	Thread Ø	M	12×1.25
		Shank length (L) when new	mm	56.0
		Shank length (L)	mm	≤57.0

Crankshaft test data

Number	Designation		Engine 904.9	Engine 906.9	
BE03.20-N-1004-02B	Conrod bearing journal Ø	Standard	mm	69.995-70.015	69.995-70.015
		Undersize -0.1	mm	69.895-69.915	69.895-69.910
		Undersize -0.25	mm	69.745-69.765	69.745-69.765
		Undersize -0.5	mm	69.495-69.515	69.495-69.515
		Undersize -0.75	mm	69.245-69.265	69.245-69.265
		Undersize -0.1	mm	68.995-69.015	68.995-69.015

 Connecting rod

Number	Designation	Engine 904.9, 906.9		
BA03.10-N-1001-01B	Bolt of conrod bearing cap to conrod	1st stage	Nm	10
		2nd stage	Nm	45
		3rd stage	∠°	90

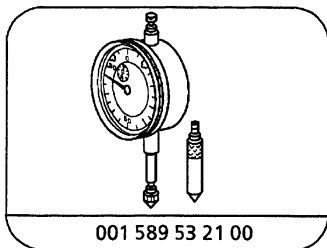

001 589 53 21 00

Dial gage

Commercially available tools (see Workshop Equipment Manual)

Number	Designation	Make (e. g.)	Order no.
WH58.30-Z-1006-12A	Micrometer 50 - 75 mm	Hahn and Kolb Borsigstr. 50 D-70469 Stuttgart	
WH58.30-Z-1009-12A	Quick calipers for internal measurements, \varnothing 100 - 120 mm		

- 1 Use the micrometer to measure the conrod bearing journals at two points (vertically and at an angle of about 90°) and note the measurements. Calculate the average value of the conrod bearing journal diameter from these two measurements.
- 2 Clean bearing points of conrod and the conrod bearing cap with a chamois leather.

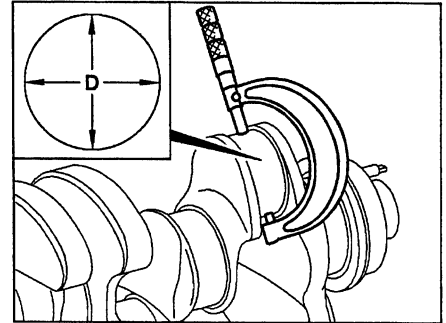

W03.10-0033-01

- 3 Insert conrod bearing shells (3) into the conrod and conrod bearing cap (2).

i Pay attention to marking on conrod bearing shells (3) and code numbers of conrod to conrod bearing cap (2).

Conrod and conrod bearing cap have different conrod bearing shells (3). Pay attention to abbreviated part number on the rear of the conrod bearing shell halves.

If the conrod bearings are replaced, install conrod bearing shells (3) of the matching installation size. Pay attention to measured conrod bearing journal diameter.

The locking lugs (arrows) of the conrod bearing shells must be located in the slots of the basic bore of the conrod bearing cap (2) and of the conrod.

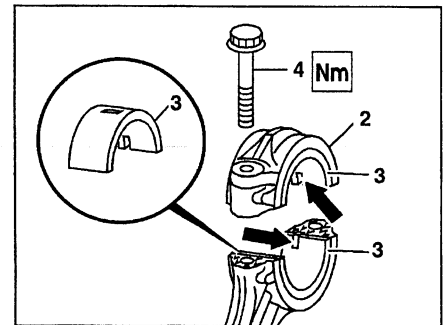

W03.10-0002-01

- 4 Mount conrod bearing cap (2) onto the conrod to fit exactly.

! Code numbers on conrod and on conrod bearing cap (2) must be aligned and be positioned on one side. The cracked contact surface must not be damaged.

- 5 **Nm** Lightly oil thread and head contact surface of the conrod bolt (4) and tighten fully with wrench socket.

i Press on conrod bearing cap (2) at conrod by hand when screwing in conrod bolt (4).

! Clamp conrod just below the conrod bearing in order to prevent it turning.

6 Set dial gage and quick calipers with the micrometer to the previously calculated measured value (average value) of the conrod bearing journal diameter (preload 5 mm).

7 Measure conrod bearing bore with dial gage and quick calipers at three points (A, B, C) and note measurements.

i If one of the measurements obtained is not within the tolerance, replace conrod bearing shells.

The conrod bearing shells are factory-supplied ready for installation. It is not permitted to carry out any reworking of the main bearing shells.

8 Take off conrod bearing caps (2) again.

⚠ Never tighten conrod bearing cap (2) fully at the conrod without the conrod bearing shells (3) inserted, only tighten so that they make contact. Measure the shank length at the conrod bolts (4) before re-installing.

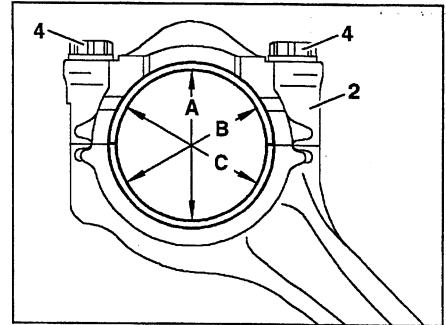

W03.10-0003-01

ENGINE 904.905 /906 /907 /909 /910 /911 /915 /916 /917 /921 /922, 906.910 /911 /915 /916 /919 /920 /921 /922 /923 /925 /926 /927 /928 /939 /942 /943

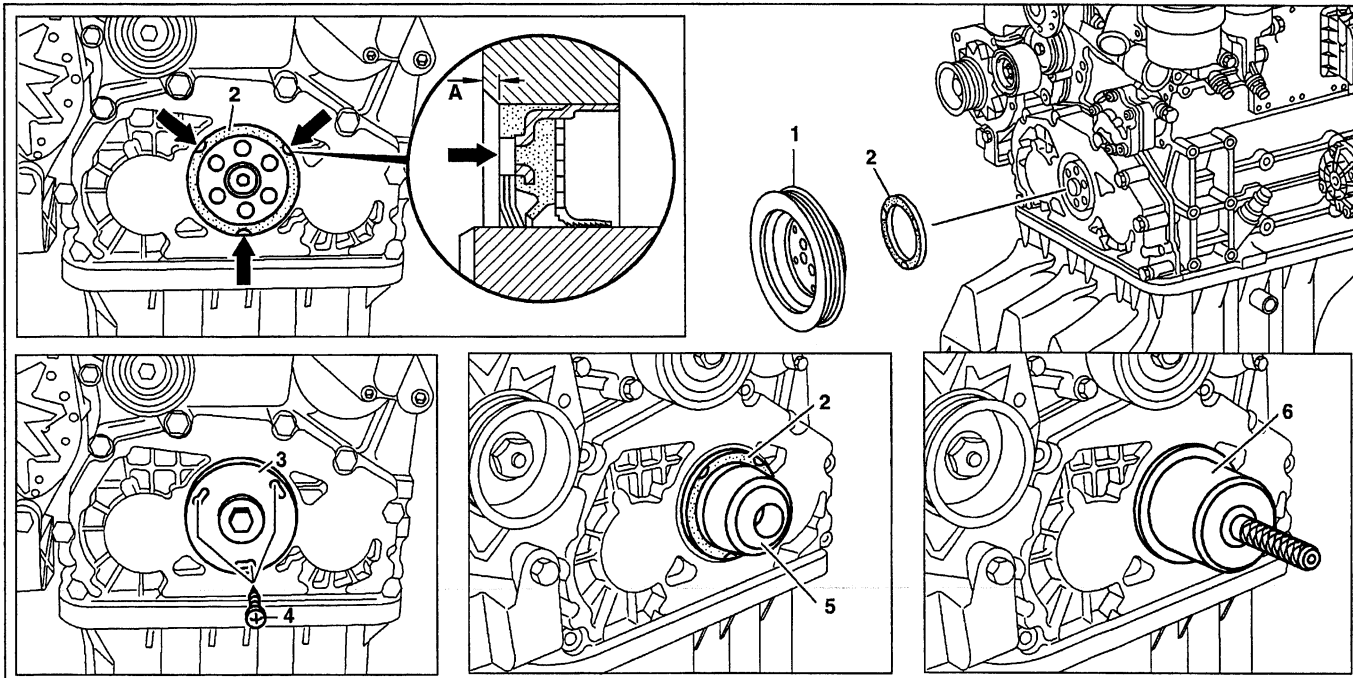

ENGINE 904.908 /923 in MODEL 668, 670

ENGINE 906.940 /941 /951 /952 in MODEL 957









W03.20-0032-09

- 1 Vibration damper
2 Radial seal
3  Puller
4 Self-tapping screws

- 5  Guide sleeve
6  Drift

A Setback of radial seal to oil pump housing

	Removing		
1	Remove vibration damper (1)	Engine 904.905-907/909-911/915-917/921/922 Engine 906.910/911/915/916/919-923/925-928/939/940/941/942/943/951/952 Engine 904.908/923	Page 46 AR03.30-D-1600D
2	Screw puller (3) tight to the radial seal (2) with three self-tapping screws (\varnothing 3.2 mm) (4)	 Three holes are provided at the radial seal. These are covered with plastic. The position of the holes can be recognized from the three recesses (arrows) of the felt cover.	
3	Pull off radial seal (2)		904 589 00 33 00
	Inspecting		
4	Inspect contact surface at the crankshaft for scores or running-in wear		
	Installing		
5	Position guide sleeve (5) at the crankshaft and push radial seal (2) over the guide sleeve (5)	 Sealing lip of radial seal must be pointing at the guide sleeve in the direction of the oil pump. 	904 589 02 15 00

6	Press radial seal (2) into the oil pump	<p>i Press in radial seal dry, axially parallel and evenly over the entire circumference. Pay attention to installation position and setback (A) of 1.5 mm Do not damage radial seal when installing.</p> <p>⚠</p>	904 589 02 15 00
7	Install vibration damper (1)	<p>Engine 904.905-907/909-911/915-917/921/922</p> <p>Engine 906.910/911/915/916/919-923/925-928/939/940/941/942/943/951/952</p> <p>Engine 904.908/923</p>	<p>Page 46</p> <p>AR03.30-D-1600D</p>

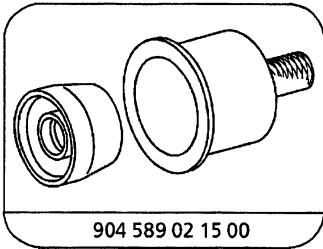

904 589 02 15 00

Drift

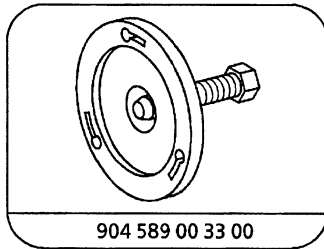

904 589 00 33 00

Puller

ENGINE 904.905 /906 /907 /909 /910 /911 /915 /916 /917 /921 /922, 906.910 /911 /915 /916 /919 /920 /921 /922 /923 /925 /926 /927 /928 /939 /942 /943







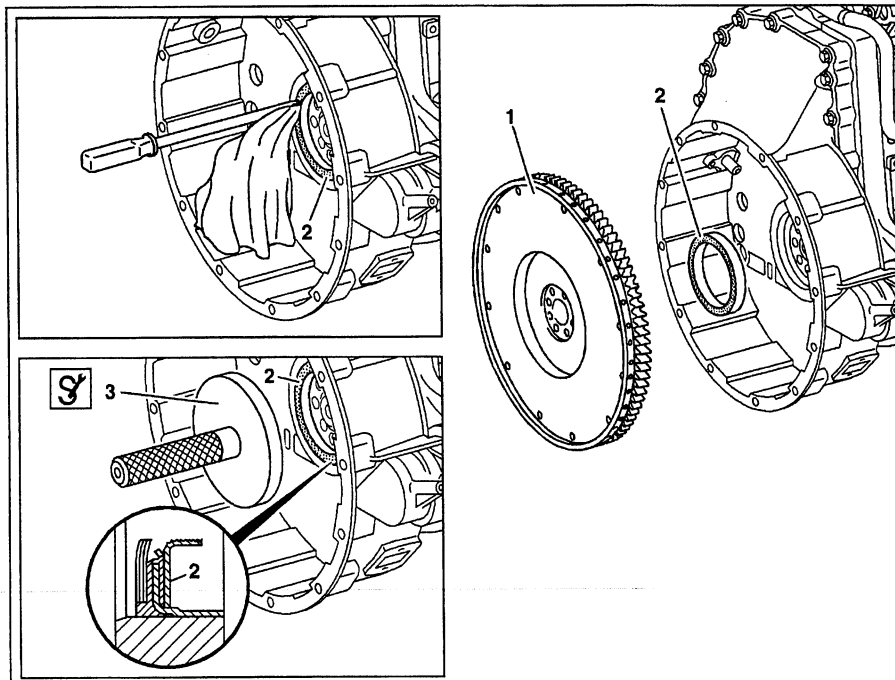

ENGINE 904.908 /923 in MODEL 668, 670

ENGINE 906.940 /941 /951 /952 in MODEL 957

- 1 Flywheel
2 Radial seal
3  Drift



W03.20-0033-06

	Removing		
1	Remove flywheel (1)		Page 49
2	Press out radial seal (2)	 Cover over crankshaft with a cloth as a protection.	
	Inspecting		
3	Inspect running surface of flywheel for scores or running-in wear	 If wear present, a radial seal with race is available for repairs.	
	Installing		
4	Position radial seal (2) at the timing case and press in	  Press in radial seal dry, axially parallel and evenly over the entire circumference. Pay attention to installation position of the radial seal. Do not damage radial seal when installing.  The drift must be positioned at the crankshaft flange. Inspect the sealing lip of the radial seal after installing to make sure it is correctly positioned.	904 589 03 15 00
5	Install flywheel (1)		Page 49

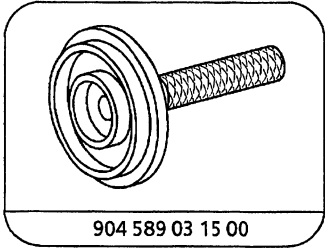

Drift

ENGINE 904.905 /906 /907 /908 /909 /910 /911 /915 /916 /917 /921 /922 /923, 906.910 /911 /915 /916 /919 /920 /921 /922 /923 /925 /926 /927 /928 /939 /940 /941 /942 /943 /951 /952

Engine 904

- 1 Crankshaft
- 2 Top crankshaft bearing shell
- 3 Bottom crankshaft bearing shell
- 4 Thrust washer (fit bearing)
- 5 Main bearing cap
- 6 Main bearing cap (fit bearing)
- 7 Main bearing cap bolt
- 8 Crankshaft sprocket
- 9 Pin

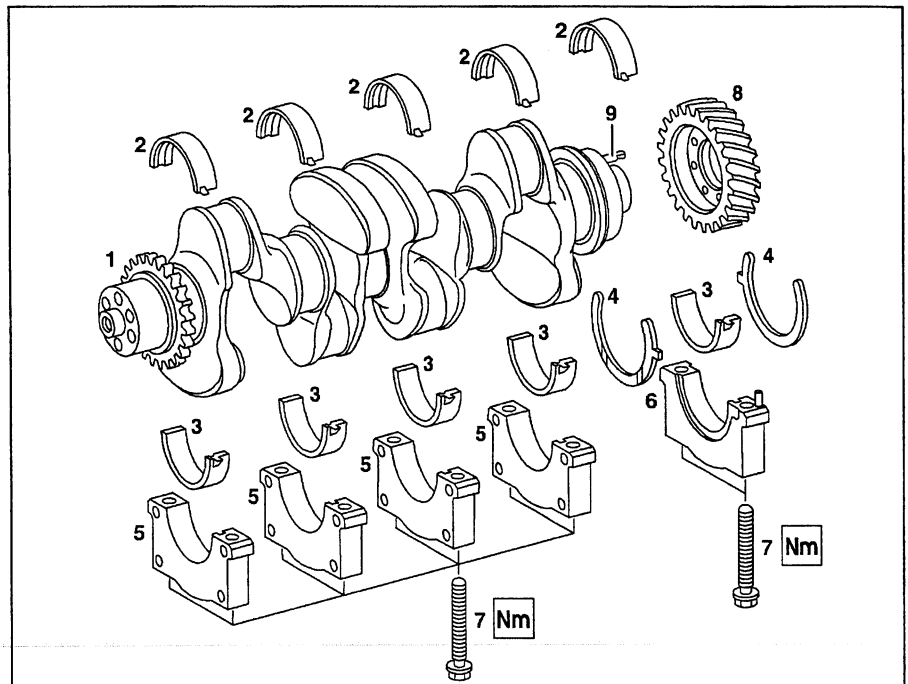

W03.20-0038-06

Engine 906

- 1 Crankshaft
- 2 Top crankshaft bearing shell
- 3 Bottom crankshaft bearing shell
- 4 Thrust washer (fit bearing)
- 5 Main bearing cap
- 6 Main bearing cap (fit bearing)
- 7 Main bearing cap bolt
- 8 Crankshaft sprocket
- 9 Pin

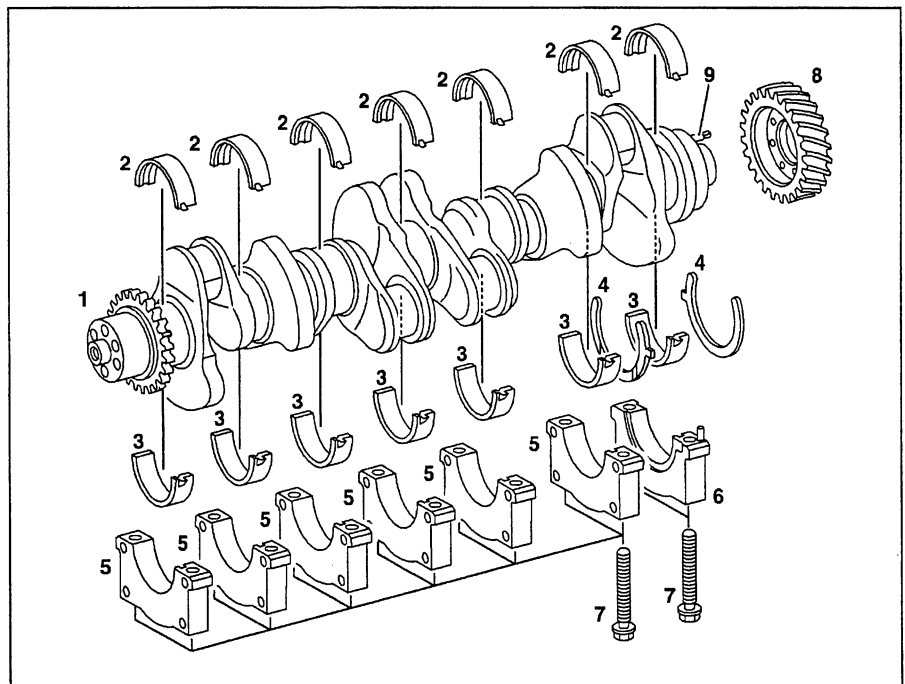

W03.20-1001-06

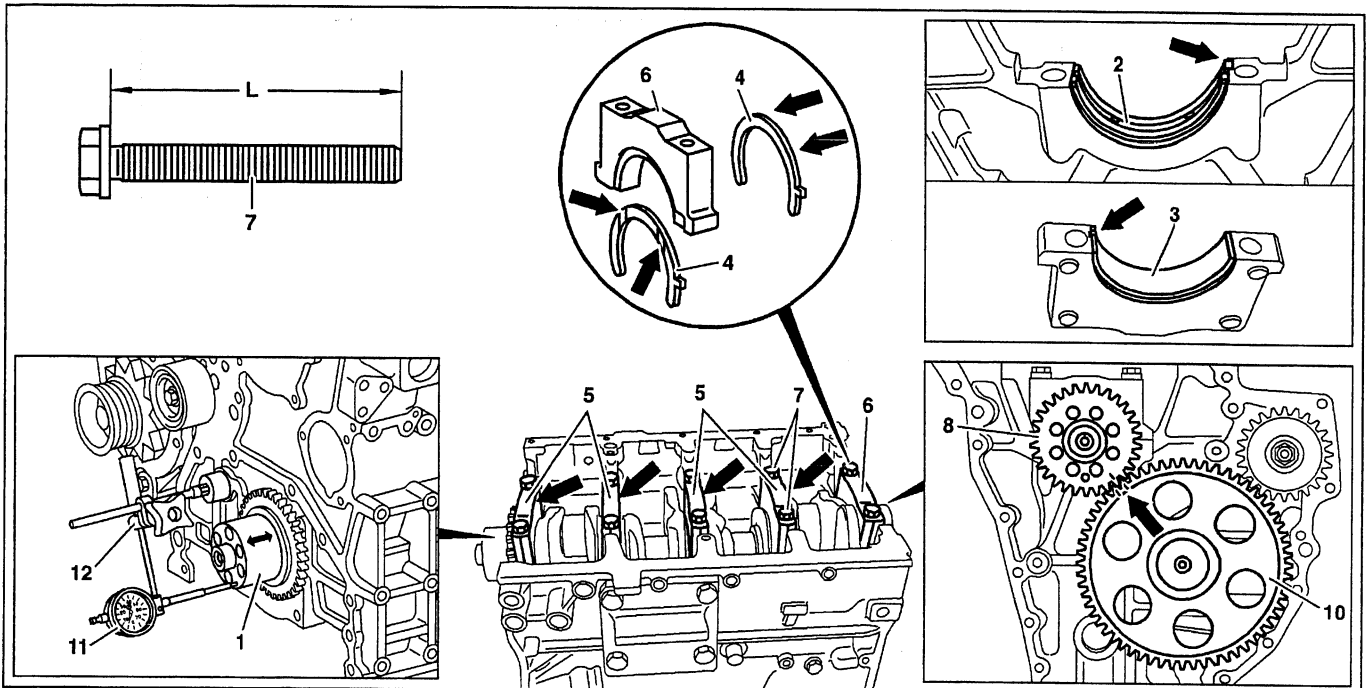

W03.20-0039-09













Shown on engine 904

- | | | | |
|---|---------------------------------|----|--|
| 1 | Crankshaft | 7 | Main bearing cap bolt shank length (L) |
| 2 | Top crankshaft bearing shell | 8 | Crankshaft sprocket |
| 3 | Bottom crankshaft bearing shell | 10 | Camshaft sprocket |
| 4 | Thrust washers (fit bearing) | 11 | <input checked="" type="checkbox"/> Dial gage |
| 5 | Main bearing cap | 12 | <input checked="" type="checkbox"/> Dial gage holder |
| 6 | Main bearing cap (fit bearing) | | |

Modification notes

24.2.00	Notes on assessing wear to crankshaft bearing shells	Step 10 added	Page 33
24.2.00	Cleaning main oil gallery	Step 11 added	AR01.40-W-8501A

<input checked="" type="checkbox"/>	Removing		
1	Remove engine	Engine 904.905- 907/921 Engine 904.908/923 Engine 904.909-911/915-917/922 Engine 906.910/911/915/916 Engine 906.920-923/925-928 Engine 906.940/941/942/943/951/952	AR01.10-W-2401A AR01.10-D-2400D AR01.10-W-2400D AR01.10-W-2400F AR01.10-W-2400C
2	Remove pistons		Page 3
3	Remove oil pump		AR18.10-W-6020A
4	Remove timing case	Engine 904.905- 911/915- 917/921/922/ 923 Engine 906.910/911/915/916/919-923/ 925-928/939/940/941/942/943/951/952 Engine 906.920-923/925-928 with timing case SAE 1 or 2, readied for engine output or installed engine output.	AR01.60-W-8200A AR01.60-W-8200F
5	Pull crankshaft sprocket (8) off the crankshaft flange		

6	Remove main bearing caps (5, 6)	<p> Mark main bearing caps one after the other.</p> <p>Engine 904: the thrust washers fit bearing (4) are installed at the 5th main bearing cap.</p> <p>Engine 906: the thrust washers fit bearing (4) are installed at the 7th main bearing cap.</p>	
7	Take off crankshaft bearing shells (3)	<p> Mark crankshaft bearing shells to relevant main bearing cap (5, 6).</p>	
8	Lift crankshaft (1) out of the crankcase with a tackle	<p> Attach shackle with existing bolts of belt pulley and the flywheel to the crankshaft.</p>	
9	Take out crankshaft bearing shells (2)	<p> Mark crankshaft bearing shells relative to crankcase.</p>	
10	Inspect crankshaft bearing shells (2) for wear	<p> Notes on assessing wear to crankshaft bearing shells</p> <p>Engine 541, 542, 904, 906</p>	Page 33
11	Cleaning main oil gallery		AR01.40-W-8501A
12	Measure crankshaft and remount		Page 36
	Installing		
13	Install crankshaft (1) with a tackle		
14	Measure main bearing bolts (7)	<p> If the shank length (L) is exceeded ↓ replace main bearing bolts.</p>	BE01.40-N-1010-02B
15	Install main bearing caps (5)	<p></p> <p> All main bearing caps are inserted at the side in the crankcase (off-centered) and identified with numbers (arrows). The main bearing caps must be installed in accordance with the numbers of the crankcase, beginning from the front, in ascending order, and must not be mixed up.</p>	BA01.40-N-1001-01C
16	Determine thickness of fit bearing shims and install main bearing caps (6)	<p>Fit bearing journal width</p> <p>Axial play</p> <p>Wall thickness of fit bearing thrust washers</p> <p></p> <p></p> <p></p>	<p>Page 34</p> <p>BE03.20-N-1002-02B</p> <p>BE03.20-N-1006-02B</p> <p>BE03.20-N-1016-02B</p> <p>BA01.40-N-1001-01C</p> <p>001 589 53 21 00</p> <p>363 589 02 21 00</p>
17	Attach crankshaft sprocket (8) to crankshaft flange	<p> Push on crankshaft sprocket; the marking "1" on the crankshaft sprocket must be positioned between the markings "1-1" of the camshaft sprocket (10).</p>	
18	Remount connecting rod and install		Page 15
19	Install pistons		Page 3
20	Install oil pump		AR18.10-W-6020A

21	Install timing case	Engine 904.905-911/915-917/921/922/923 Engine 906.910/911/915/916/919-923/ 925-928/939/940/941/942/943/951/952 Engine 906.920-923/925-928 with timing case SAE 1 or 2, readied for engine output or installed engine output.	AR01.60-W-8200A AR01.60-W-8200F
22	Replace oil filter element	Engine 904.905- 907/921 Engine 904.908/923 Engine 904.909-911/915-917/922 Engine 906.910/911/915/916/919-923/ 925-928/939/940/941/942/943/951/952	WH0101.40 AP18.00-D-0101A AP18.00-W-0101B
23	Replace oil-water heat exchanger	ⓘ Only if material abrasion present	AR18.30-W-6840A
24	Install engine	Engine 904.905- 907/921 Engine 904.908/923 Engine 904.909-911/915-917/922 Engine 906.910/911/915/916 Engine 906.920-923/925-928 Engine 906.940/941/942/943/951/952	AR01.10-W-2401A AR01.10-D-2400D AR01.10-W-2400D AR01.10-W-2400F AR01.10-W-2400C
25	Fill engine oil circuit		AR18.00-W-1600A

Inspection data of crankcase

Number	Designation	Engine 904.9, 906.9
BE01.40-N-1010-02B	Main bearing cap bolt	Thread Ø M 14
		Shank length when new mm 114.0
		Shank length mm ≤ 116.0

Crankshaft test data

Number	Designation	Engine 904.9	Engine 906.9
BE03.20-N-1002-02B	Fit bearing journal width	Standard mm 31.000-31.062	31.000-31.062
		Undersize -0.3 mm 31.300-31.362	31.300-31.362
		Undersize -0.5 mm 31.500-31.562	31.500-31.562
BE03.20-N-1006-02B	Axial play	mm 0.16-0.38	0.16-0.38
BE03.20-N-1016-02B	Fit bearing thrust washers wall thickness	Standard mm 3.240-3.300	3.240-3.300
		Oversize 0.3 mm 3.540-3.600	3.540-3.600
		Undersize 0.5 mm 3.740-3.800	3.740-3.800

Crankcase, timing case cover, end cover

Number	Designation	Engine 904.9, 906.9
BA01.40-N-1001-01C	Bolt of main bearing cap to crankcase	1st stage Nm 30
		2nd stage Nm 80
		3rd stage Nm 155
		4th stage Δ° 90

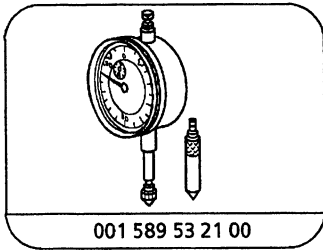

Dial gage

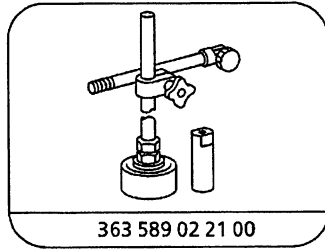

Dial gage holder

AH03.20-N-1000-02A	Notes on assessing wear of main bearings and main bearing journals	Engine 541, 542, 904, 906	i
--------------------	--	---------------------------	----------

Assessing wear of main bearings

Main bearing shell without damage

The bearing shell is uniformly smooth over the entire bearing surface and without any visible scores and wear to the friction coating.

i The damage patterns presented below are only an extract of possible types of damage to crankshaft bearing shells. When assessing the types of damage, it is always necessary to include the surface finish of the main bearing journal (waviness, roughness) in the damage diagnosis.

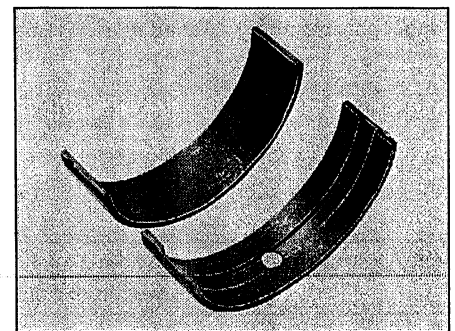

W03.20-1013-01

Wear over extensive area of friction coating on main bearing shell

The surface layer is worn off, the bearing material below this is exposed, the wear point is clearly visible as a result of the glossy point on the surface of the bearing.

i Normal wear due to long service life. If bearings are replaced within the engine, this bearing should likewise be replaced.

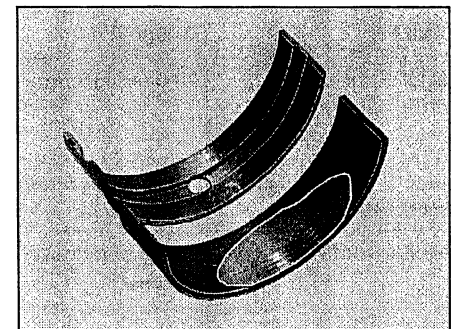

W03.20-1014-01

Assessing wear of main bearing journals

Main bearing journal without damage

The surface of the bearing journal is uniformly smooth over the entire surface and has no visible scores.

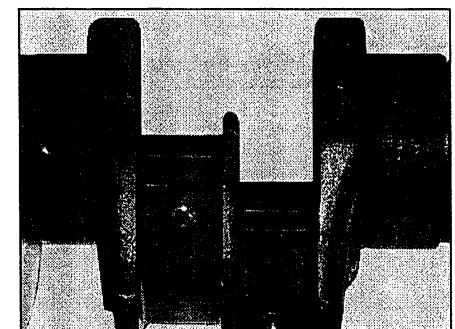

W03.20-1017-01

Slight scores and scratches around the circumference of the main bearing journal
Scores and scratches are slightly visible and perceptible on the surface.

i Caused by fine dirt particles in oil circuit. Individual dirt scores and scratches are not critical. The crankshaft can still be re-used provided the main bearing journal \varnothing is still within the tolerance; gage main bearing journal for this purpose. When carrying out maintenance and repair work, inspect the oil in the oil filter, and also the engine oil, if necessary, for soiling.

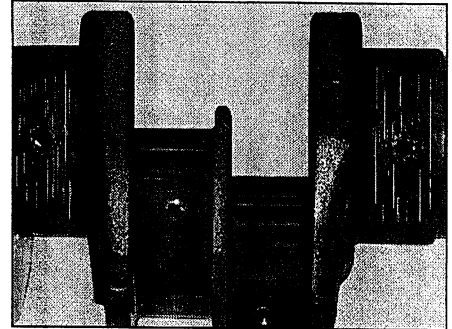

W03.20-1015-01

Severe scoring around circumference of main bearing journal
Scores are clearly visible and perceptible on the surface.

i Caused by dirt and foreign particles in the oil circuit, e.g. as a result of a faulty oil filter, use of grinding agents as well as inadequate cleaning when carrying out engine repairs. Measure the crankshaft and machine to the next oversize, if necessary. If reworking is no longer possible, the crankshaft must be replaced.

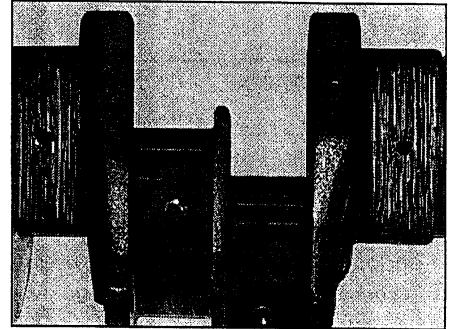

W03.20-1016-01

AR03.20-W-4351-01B	Determining thickness of fit bearing thrust washers of crankshaft		
--------------------	---	--	--

Crankshaft test data

Number	Designation		Engine 904.9	Engine 906.9
BE03.20-N-1002-02B	Fit bearing journal width	Standard	mm 31.000-31.062	31.000-31.062
		Undersize -0.3	mm 31.300-31.362	31.300-31.362
		Undersize -0.5	mm 31.500-31.562	31.500-31.562
BE03.20-N-1006-02B	Axial play	mm	0.16-0.38	0.16-0.38
BE03.20-N-1016-02B	Fit bearing thrust washer wall thickness	Standard	mm 3.240-3.300	3.240-3.300
		O/u-size 0.3	mm 3.540-3.600	3.540-3.600
		O/u-size 0.5	mm 3.740-3.800	3.740-3.800

Nm Crankcase, timing case cover, end cover

Number	Designation		Engine 904.9, 906.9
BA01.40-N-1001-01C	Bolt of main bearing cap to crankcase	1st stage	Nm 30
		2nd stage	Nm 80
		3rd stage	Nm 155
		4th stage	∠° 90

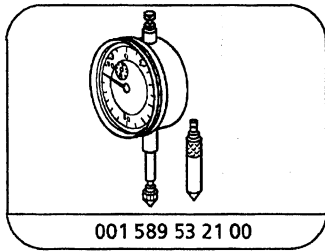

Dial gage

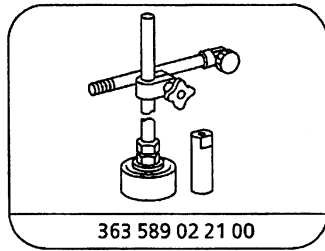

Dial gage holder

- 1 Measure fit bearing journal width (A) of crankshaft (1) and select thrust washers to match the installation size measured.

i The dimensions of the installation sizes stated in the table must be maintained. Thrust washers are factory-supplied ready for installation and also in oversizes for repairs. It is not permitted to carry out any reworking of the main bearing shells.

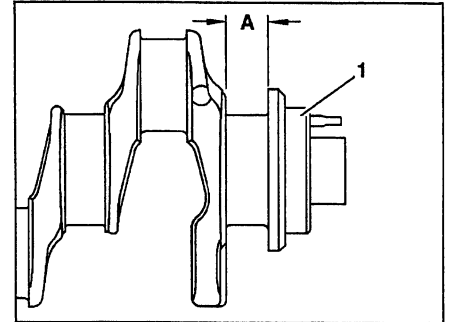

W03.20-0034-01

- 2 Oil thrust washers (2) and insert into the grooves at the main bearing cap (fit bearing) (3).

i Only thrust washers (2) of the same wall thickness may be installed. Both oil grooves (arrows) in the thrust washers must point toward the crankshaft webs.

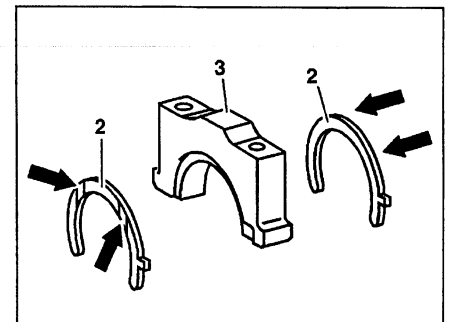

W03.20-0035-01

- 3 **Nm** Install main bearing cap (fit bearing) (3).

i Oil main bearing bolts.

The main bearing cap is fitted into the crankcase at the side (off-centered) and marked with numbers (arrow).

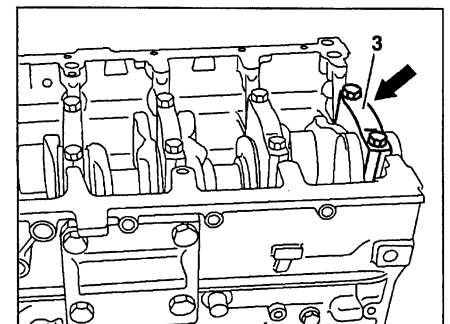

W03.20-1003-01

- 4 Rotate crankshaft by hand and inspect clearance.

- 5 **☑** Fit on dial gauge holder (4) and **☑** dial gauge (5) with a preload at the crankcase.

- 6 Move crankshaft (1) from stop to stop and read off measurement (axial play).

i The axial play must not be greater than the specification.

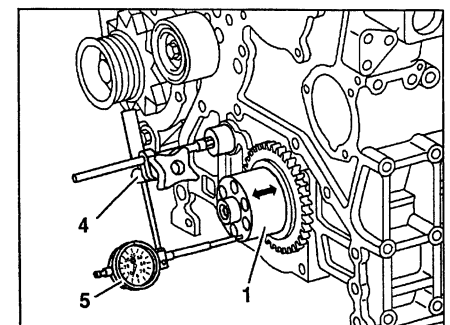

W03.20-0037-01

ENGINE 904.905 /906 /907 /908 /909 /910 /911 /915 /916 /917 /921 /922 /923, 906.910 /911 /915 /916 /919 /920 /921 /922 /923 /925 /926 /927 /928 /939 /940 /941 /942 /943 /951 /952

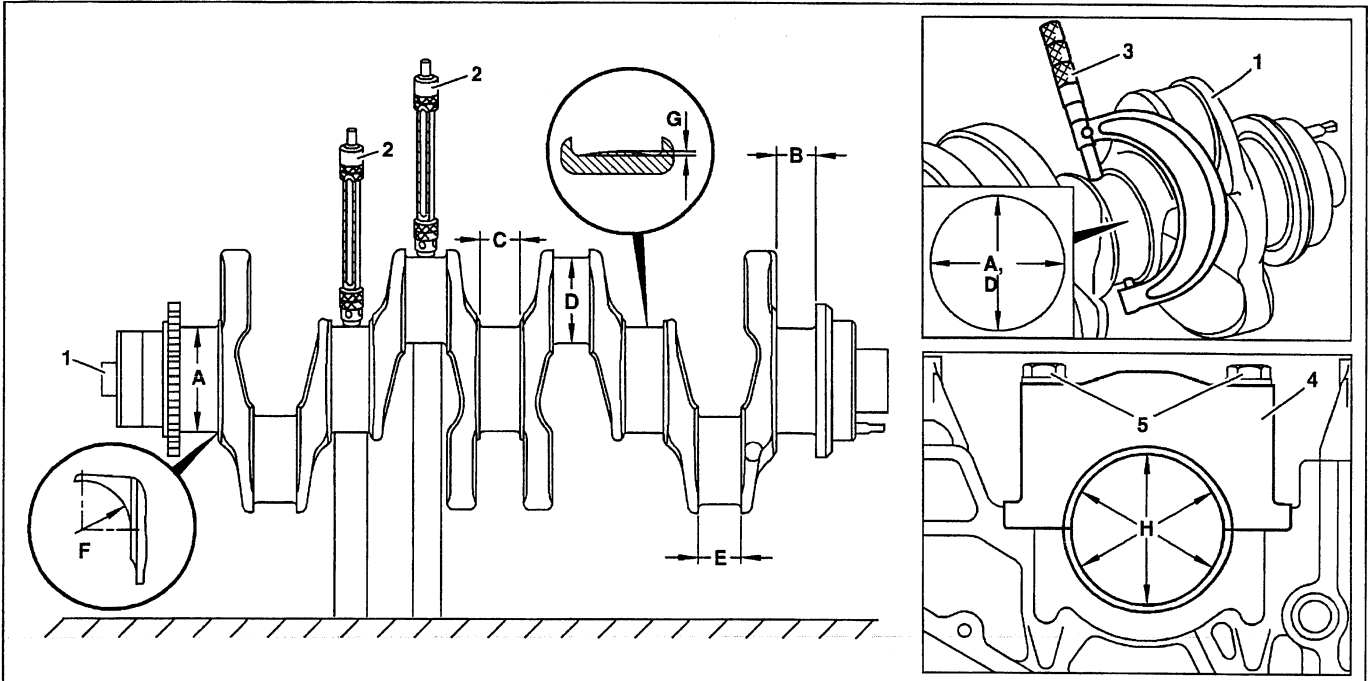

W03.20-0042-09

- 1 Crankshaft
- 2 Drop hardness tester
- 3 Micrometer
- 4 Main bearing cap
- 5 Main bearing bolt

- A Main bearing journal \varnothing
- B Fit bearing journal width
- C Main bearing journal width
- D Conrod bearing journal \varnothing
- E Conrod bearing journal width
- F Fillet radii of main and conrod bearing journals
- G Convexity of main and conrod bearing journals
- H Main bearing inner \varnothing when installed



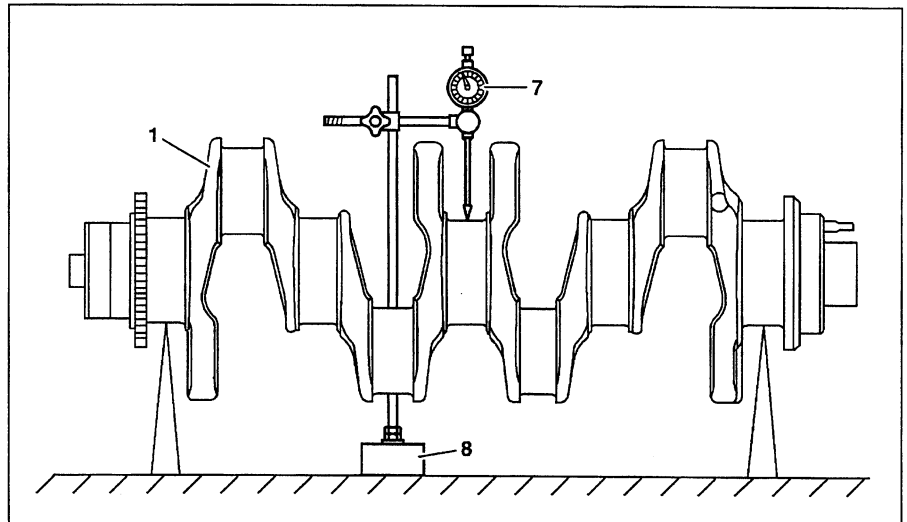

- 1 Crankshaft
- 7 Dial gage
- 8 Dial gage holder



W03.20-0043-05

	Inspecting		
1	Remove crankshaft		Page 29

2	Clean engine components	<p>ⓘ After bearing damage has occurred, it is important to remove any swarf from the conrod bores and the crankshaft and crankcase oil galleries ↓</p> <p>Cleaning, sealing main oil gallery</p>	AR01.40-W-8501A
3	Clean crankshaft		
4	Inspect front of crankshaft flange for wear	<p>ⓘ If wear present, a radial seal with race is available for repairs.</p>	
5	Inspect main and conrod bearing journals for damage and cracks	<p>ⓘ If damage or cracks present ↓</p> <p>replace crankshaft</p>	
6	Inspect hardness of main and conrod bearing journals with drop hardness tester (2)	<p>ⓘ</p> <p>ⓘ The bearing journal to be tested must be placed on a base for the test. The specified hardness must be achieved at at least two thirds of the circumference of the bearing journal.</p> <p>If the specified hardness is not achieved ↓</p> <p>reharden or replace crankshaft</p>	<p>000 589 20 21 00</p> <p>BE03.20-N-1013-02B</p>
7	Measure variation of concentricity of crankshaft (1)	<p>ⓘ Measured at middle main bearing journal, mounted on outer main bearing journals.</p> <p>ⓘ</p> <p>ⓘ</p>	<p>BE03.20-N-1011-02B</p> <p>001 589 53 21 00</p> <p>363 589 02 21 00</p>
8	Measure main and conrod bearing journals	<p>Use the micrometer to measure main bearing journal \varnothing (A) at two points (offset approx. 90°).</p> <p>ⓘ Micrometer</p> <p>Main and conrod bearing journal permissible variation of out-of-roundness</p> <p>Permissible conicity at main bearing journal and conrod bearing journal</p> <p>Permissible lateral runout at fit bearing journal</p> <p>Main bearing journal width (C)</p> <p>Fit bearing journal width (B)</p> <p>Use the micrometer to measure fit bearing journal \varnothing (D) at two points (offset approx. 90°)</p> <p>ⓘ Micrometer</p> <p>Conrod bearing journal width (E)</p> <p>Fillet radii (F) of main and conrod bearing journals</p> <p>Convexity (G) of main and conrod bearing journals</p> <p>ⓘ If damage and wear present ↓</p> <p>machine crankshaft to the next oversize.</p>	<p>BE03.20-N-1001-02B</p> <p>WH58.30-Z-1013-12A</p> <p>BE03.20-N-1008-02B</p> <p>BE03.20-N-1009-02B</p> <p>BE03.20-N-1010-02B</p> <p>BE03.20-N-1003-02B</p> <p>BE03.20-N-1002-02B</p> <p>BE03.20-N-1004-02B</p> <p>WH58.30-Z-1006-12A</p> <p>BE03.20-N-1005-02B</p> <p>BE03.20-N-1012-02B</p> <p>BE03.20-N-1014-02B</p>

		<p>Engine 904 Permissible imbalance of crankshaft (with pin for locating flywheel but without flywheel), mounted at the outer main bearings.</p> <p>Engine 906 Permissible imbalance of crankshaft (with pin for locating flywheel but without flywheel), mounted at main bearings two and six.</p>	<p>BE03.20-N-1019-02B</p> <p>BE03.20-N-1021-02B</p>
	Mounting		
9	Mount crankshaft (1) radially	<p>Main bearing journal \varnothing (A)</p> <p>Main bearing inner \varnothing (H) when installed.</p> <p> Main bearing bolts for main bearing caps to crankcase</p> <p></p> <p> Quick calipers</p> <p> Micrometer</p>	<p>Page 41</p> <p>BE03.20-N-1001-02B</p> <p>BE03.20-N-1015-02B</p> <p>BA01.40-N-1001-01C</p> <p>001 589 53 21 00</p> <p>WH58.30-Z-1001-12A</p> <p>WH58.30-Z-1013-12A</p>
10	Install crankshaft (1)		Page 29

Crankshaft test data

Number	Designation			Engine 904.9	Engine 906.9
BE03.20-N-1001-02B	Main bearing journal \varnothing	Standard	mm	85.990-86.010	85.990-86.010
		Undersize -0.1	mm	85.890-85.910	85.890-85.910
		Undersize -0.25	mm	85.740-85.760	85.740-85.760
		Undersize -0.5	mm	85.490-85.510	85.490-85.510
		Undersize -0.75	mm	85.240-85.260	85.240-85.260
		Undersize -0.1	mm	84.990-85.010	84.990-85.010
BE03.20-N-1002-02B	Fit bearing journal width	Standard	mm	31.000-31.062	31.000-31.062
		Undersize -0.3	mm	31.300-31.362	31.300-31.362
		Undersize -0.5	mm	31.500-31.562	31.500-31.562
BE03.20-N-1003-02B	Main bearing journal width		mm	31.0-31.2	31.0-31.2
BE03.20-N-1004-02B	Conrod bearing journal \varnothing	Standard	mm	69.995-70.015	69.995-70.015
		Undersize -0.1	mm	69.895-69.915	69.895-69.915
		Undersize -0.25	mm	69.745-69.765	69.745-69.765
		Undersize -0.5	mm	69.495-69.515	69.495-69.515
		Undersize -0.75	mm	69.245-69.265	69.245-69.265
		Undersize -0.1	mm	68.995-69.015	68.995-69.015
BE03.20-N-1005-02B	Conrod bearing journal width		mm	34.0-34.2	34.0-34.2
BE03.20-N-1008-02B	Main and conrod bearing journals permissible variation of out-of-roundness	Limit value	mm	0.005	0.005
BE03.20-N-1009-02B	Permissible conicity	Main bearing journal	mm	0.005	0.005
		Conrod bearing journal	mm	0.005	0.005
BE03.20-N-1010-02B	Permissible radial runout	Fit bearing journal	mm	0.015	0.015
BE03.20-N-1011-02B	Variation in concentricity measured at middle main bearing journal (mounted at outer main bearing journals)		mm	0.11	0.15
BE03.20-N-1012-02B	Fillet radii	Main bearing journal	mm	2.5-3.0	2.5-3.0
		Conrod bearing journal	mm	2.5-3.0	2.5-3.0
BE03.20-N-1013-02B	Hardness of main bearing and conrod bearing journals (Rockwell hardness)		HRC	≥ 52	≥ 52
BE03.20-N-1014-02B	Convexity	Main bearing journal	mm	0.000-0.004	0.000-0.004
		Conrod bearing journal	mm	0.000-0.004	0.000-0.004

Crankshaft test data

Number	Designation		Engine 904.9	Engine 906.9	
BE03.20-N-1015-02B	Main bearing inner \varnothing	Standard	mm	86.066-86.108	86.066-86.108
		Undersize 0.1	mm	85.966-86.008	85.966-86.008
		Undersize 0.25	mm	85.816-85.858	85.816-85.858
		Undersize 0.5	mm	85.566-85.608	85.566-85.608
		Undersize 0.75	mm	85.316-85.358	85.316-85.358
		Undersize 1.0	mm	85.066-85.108	85.066-85.108
BE03.20-N-1019-02B	Permissible imbalance of crankshaft (with pin for locating flywheel but without flywheel), mounted at the outer main bearings.	gcm	30	-	
BE03.20-N-1021-02B	Permissible imbalance of crankshaft (with pin for locating flywheel but without flywheel), mounted at main bearings two and six.	gcm	-	30	

Crankcase, timing case cover, end cover

Number	Designation		Engine 904.9, 906.9
BA01.40-N-1001-01C	Bolt of main bearing cap to crankcase	1st stage	Nm 30
		2nd stage	Nm 80
		3rd stage	Nm 155
		4th stage	\angle° 90

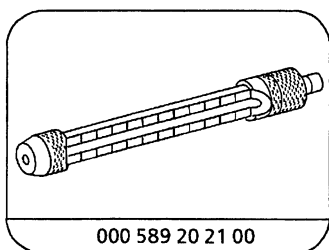

000 589 20 21 00

Hardness tester

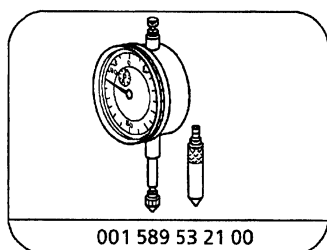

001 589 53 21 00

Dial gage

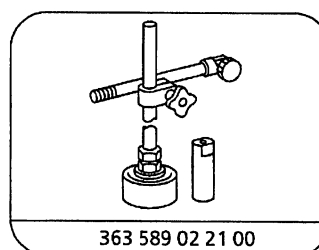

363 589 02 21 00

Dial gage holder

Commercially available tools (see Workshop Equipment Manual)

Number	Designation	Make (e. g.)	Order no.
WH58.30-Z-1001-12A	Quick calipers for internal measurements, \varnothing 80 - 100 mm		
WH58.30-Z-1006-12A	Micrometer 50 - 75 mm		
WH58.30-Z-1013-12A	Micrometer 75 - 100 mm		

AR03.20-W-4355-01B	Positioning crankshaft in mounts radially		
--------------------	---	--	--

Crankshaft test data

Number	Designation			Engine 904.9	Engine 906.9
BE03.20-N-1001-02B	Main bearing journal \varnothing	Standard	mm	85.990-86.010	85.990-86.010
		Undersize -0.1	mm	85.890-85.910	85.890-85.910
		Undersize -0.25	mm	85.740-85.760	85.740-85.760
		Undersize -0.5	mm	85.490-85.510	85.490-85.510
		Undersize -0.75	mm	85.240-85.260	85.240-85.260
		Undersize -0.1	mm	84.990-85.010	84.990-85.010
BE03.20-N-1015-02B	Main bearing inner \varnothing	Standard	mm	86.066-86.108	86.066-86.108
		Undersize 0.1	mm	85.966-86.008	85.966-86.008
		Undersize 0.25	mm	85.816-85.858	85.816-85.858
		O/u-size 0.5	mm	85.566-85.608	85.566-85.608
		Undersize 0.75	mm	85.316-85.358	85.316-85.358
		Undersize 1.0	mm	85.066-85.108	85.066-85.108

Crankcase, timing case cover, end cover

Number	Designation			Engine 904.9, 906.9
BA01.40-N-1001-01C	Bolt of main bearing cap to crankcase	1st stage	Nm	30
		2nd stage	Nm	80
		3rd stage	Nm	155
		4th stage	Δ°	90

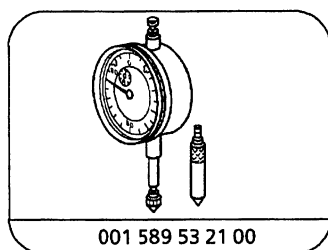



Dial gage

Commercially available tools (see Workshop Equipment Manual)

Number	Designation	Make (e. g.)	Order no.
WH58.30-Z-1001-12A	Quick calipers for internal measurements, \varnothing 80 - 100 mm		
WH58.30-Z-1013-12A	Micrometer 75 - 100 mm		

1 Clean bearing points of crankshaft with a chamois leather.

2 Use  micrometer to measure main bearing inner \varnothing (D) at two points (offset approx. 90°).

 The dimensions stated in the table must be maintained. If one of the measurements obtained is not within the tolerance, machine crankshaft.

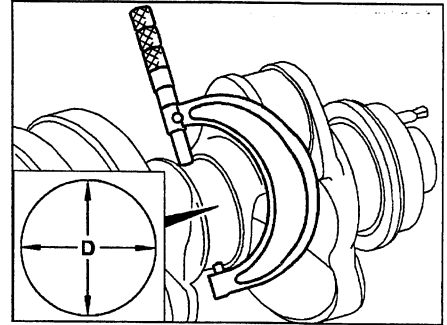

W03.20-0040-01

3 Clean bearing points in crankcase and main bearing cap with a chamois leather.

4 Insert crankshaft bearing shells (2) in the marked order into the crankcase.

 The locking lug (arrow) of the crankshaft bearing shells (2) must be located in the slots of the crankshaft basic bores. Oil drillings in the crankshaft bearing shell (2) in crankcase must be aligned.

5 Insert crankshaft bearing shells (1) in the marked order into the main bearing caps (3, 4).

 The locking lugs (arrows) of the crankshaft bearing shells (1) must be located in the slots of the main bearing caps (3).

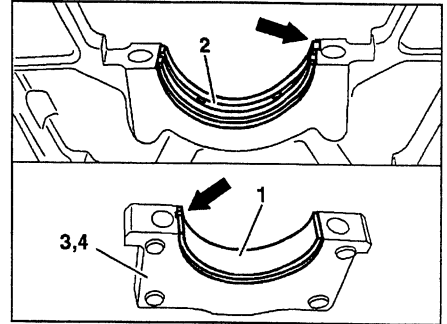

W03.20-0041-01

6 Fit main bearing caps (3, 4) onto the crankcase.

 All the main bearing caps are inserted into the crankcase at the side (off-centered) and marked with numbers (arrows). They must be installed in ascending order in accordance with the numbers, beginning from the front of the crankcase, and must not be mixed up.

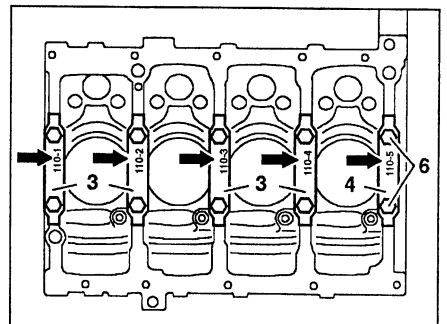

Engine 904

W03.20-0004-01

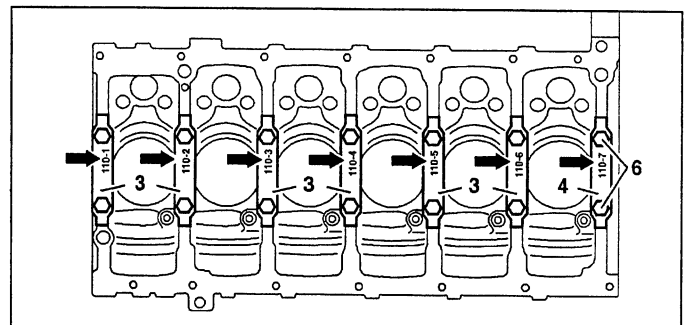

Engine 906

W03.20-1004-10

- 7 Use the micrometer to set dial gauge and quick calipers to the nominal dimension of the main bearing journal (preload 5 mm).
- 8 Use dial gauge and quick calipers to measure crankshaft bearing bores in crankcase at three points (A, B, C) (vertically and each about 30° away from separation points).

i The dimensions stated in the table must be maintained. If one of the measurements obtained (A, B, C) is not within the tolerance, replace main bearing shells to match the measured main bearing journals.

Main bearing shells are factory-supplied ready for installation and also in oversizes for repair work. It is not permitted to carry out any reworking of the main bearing shells.

- 9 Take off main bearing caps (3, 4) again.

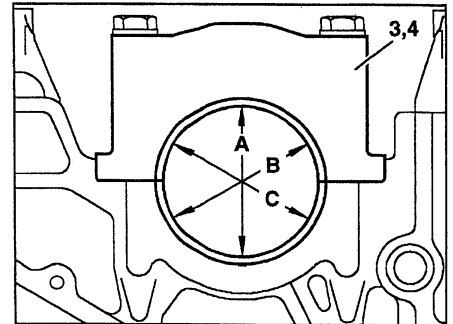

W03.20-0005-01

ENGINE 904.905 /906 /907 /909 /910 /911 /915 /916 /917 /921 /922, 906.910 /911 /915 /916 /919 /920 /921 /922 /923 /925 /926 /927 /928 /939 /942 /943

ENGINE 904.908 /923 in MODEL 668, 670

ENGINE 906.940 /941 /951 /952 in MODEL 957

- 1 Timing case
- 2 Crankshaft sprocket
- 3 Camshaft sprocket

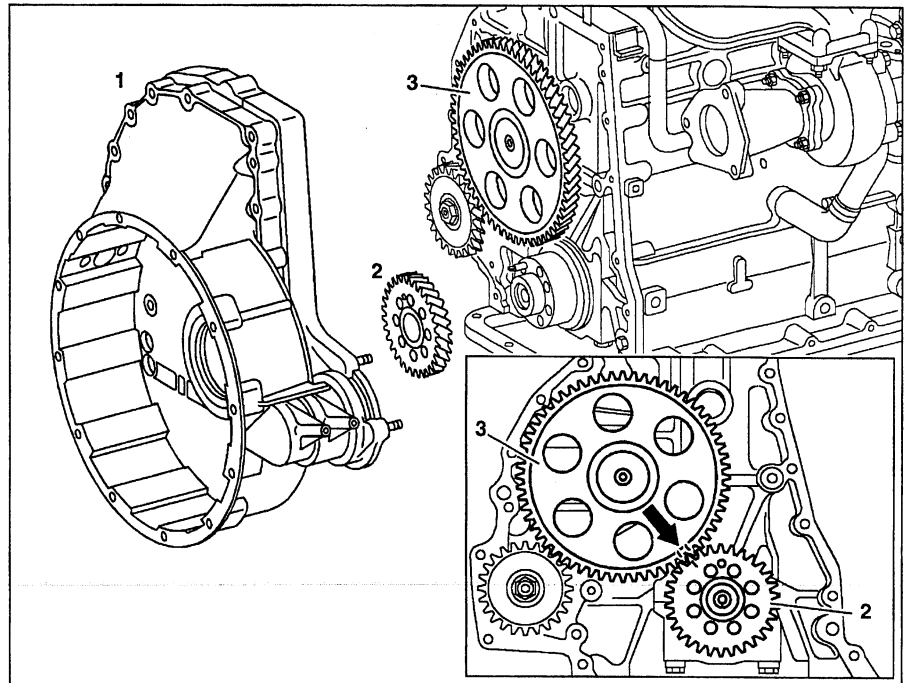

W03.20-0007-06

☒ ☒	Removing, installing		
1	Remove timing case (1)	Engine 904.905-911/915-917/921/922/923 Engine 906.910/911/915/916/919-923/ 925-928/939/940/941/942/943/951/952 Engine 906.920-923/925-928 with timing case SAE 1 or 2, readied for engine output or installed engine output.	AR01.60-W-8200A AR01.60-W-8200F
2	Pull crankshaft sprocket (2) off the crankshaft	<p>i Rotate crankshaft until the marking "1" on the crankshaft sprocket (2) is aligned with the marking "1-1" (arrow) on the camshaft sprocket (3).</p> <p>i Installation: The marking "1" on the crankshaft sprocket must be located between the marking "1-1" (arrow) on the camshaft sprocket.</p>	
3	Install in the reverse order		

ENGINE 904.905 /906 /907 /909 /910 /911 /915 /916 /917 /921 /922, 906.910 /911 /915 /916 /919 /920 /921 /922 /923 /925 /926 /927 /928 /939 /942 /943

ENGINE 904.908 /923 in MODEL 668, 670

ENGINE 906.940 /941 /951 /952 in MODEL 957

- 1 Drive gear
- 2 Crankshaft

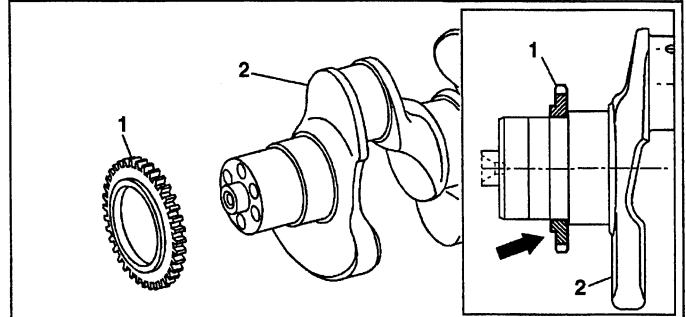

W03.20-0006-10

☒ ☒	Removing, installing		
1	Remove crankshaft		Page 29
⚠ Danger!	Risk of injury to skin and eyes from handling hot or glowing objects.	Wear protective gloves, protective clothes and, if necessary, eye protection.	Page 45
2	Pull drive gear (1) off the crankshaft (2)	Heat drive gear to approx. 200 °C. i Installation: Heat new drive gear to approx. 200 °C and press onto the crankshaft. Pay attention to installation position of the chamfer (arrow).	
3	Install in the reverse order		

AS00.00-Z-0002-01A	Risk of injury to skin and eyes from handling hot or glowing objects	Wear protective gloves, protective clothing and, if appropriate, eye protection.	⚠ Danger!
--------------------	--	--	------------------

Risk of injury

Contact with hot or glowing objects without suitable protective clothing causes severe burns to the skin and eyes.
Contact between glowing objects and water produces hot water vapor or splashes which can cause severe burns to skin and eyes.
If hot or glowing objects come into contact with unprotected skin or eyes, this can cause severe and even permanent injury.

i Contact between glowing objects and combustible substances produces a risk of fire.

Protective measures/rules of conduct

- Wear protective clothing, eye protection, heat-resistant gloves.
- Transport hot or glowing objects only with the aids and equipment provided for this purpose.
- Avoid sparks and contact with combustible substances when handling glowing objects.

First-aid measures







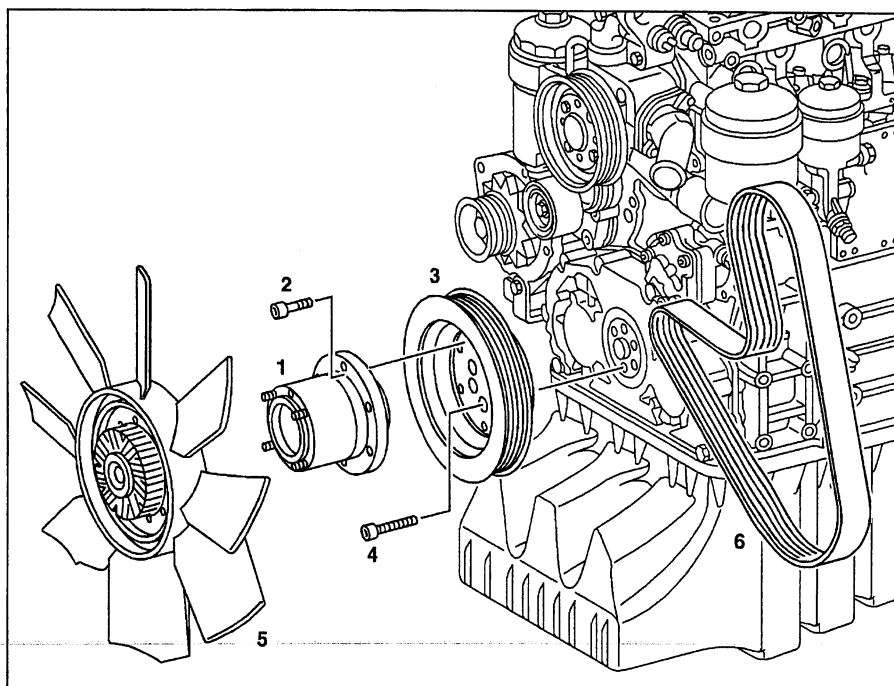

- Pour plenty of cold water over the affected areas of skin and cover with sterile bandages.
- Consult a doctor without delay.

ENGINE 904.905 /906 /907 /909 /910 /911 /915 /916 /917 /921 /922, 906.910 /911 /915 /916 /919 /920 /921 /922 /923 /925 /926 /927 /928 /939 /940 /941 /942 /943 /951 /952

- 1 Adapter piece
- 2 Hexagon socket bolt
- 3 Vibration damper
- 4 Internally serrated bolt
- 5 Viscous fan
- 6 Poly V-belt



W03.30-0017-06

	Removing, installing		
1	Slacken poly V-belt (6) and take off		AR13.25-W-3200A
2	Take off cover at timing case		BA01.60-N-1002-01A
3	Install cranking and blocking device for engine at timing case	 Block cranking and blocking device by inserting the pin. 	Page 48 904 589 04 63 00
4	Remove viscous fan (5)		AR20.40-W-5614C
5	Remove intermediate piece (1)		BA03.30-N-1003-01C
6	Remove vibration damper (3)	 For bolt M14  For bolt M16 	904 589 00 10 00 904 589 01 10 00 BA03.30-N-1002-01C
7	Measure shank length of internally serrated bolts (4)	Internally serrated bolt M14 Internally serrated bolt M16  If shank length exceeded ↓ replace internally serrated bolt	BE03.30-N-1001-02B BE03.30-N-1002-02B
8	Install in the reverse order		

Belt pulley/vibration damper

Number	Designation	Engine 904.9, 906.9		
BE03.30-N-1001-02B	Bolt of vibration damper to crankshaft	Thread diameter	M	14×1.5
		Shank length when new	mm	60.0
		Shank length	mm	≤61.0
BE03.30-N-1002-02B	Bolt of vibration damper to crankshaft	Thread diameter	M	16×1.5
		Shank length when new	mm	61.0
		Shank length	mm	≤61.8

Nm Timing case

Number	Designation	Nm	Engine 904.9, 906.9
BA01.60-N-1002-01A	End cover of inspection hole to timing case	25	

Nm Flywheel, driven plate, vibration damper, starter ring gear

Number	Designation	Engine 904.9, 906.9		
BA03.30-N-1002-01C	Bolt of vibration damper to crankshaft	M16	1st stage	Nm 50
			2nd stage	Nm 210
			3rd stage	∠° 90
		M14	1st stage	Nm 50
			2nd stage	Nm 125
			3rd stage	∠° 90
BA03.30-N-1003-01C	Bolt of intermediate piece of vibration damper	Nm	60	

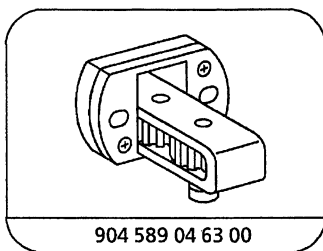

904 589 04 63 00

Cranking device

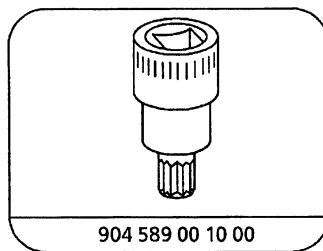

904 589 00 10 00

Screwdriver bit

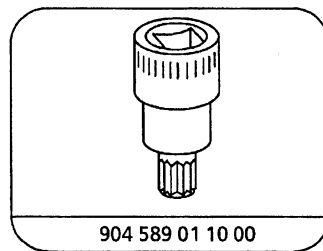

904 589 01 10 00

Screwdriver bit

AR03.30-W-1600-03A	Attaching, detaching cranking/blocking device for engine		
--------------------	--	--	--

Nm Timing case

Number	Designation	Engine	
		904.9, 906.9	
BA01.60-N-1002-01A	End cover of inspection hole to timing case	Nm	25

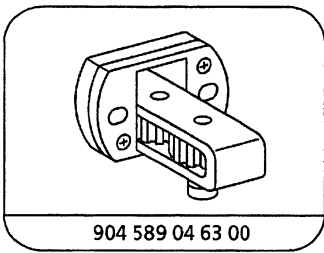

Cranking device

- 1 Remove noise encapsulation below flywheel housing.
- 2 Remove cover (1) at flywheel housing (if fitted).
- 3 Attach cranking and blocking device (2) tight to flywheel housing with bolts (4).
- Cranking and blocking device (2) can be blocked by inserting the pin (3).
- Cranking and blocking device (2) must be removed before starting the engine.

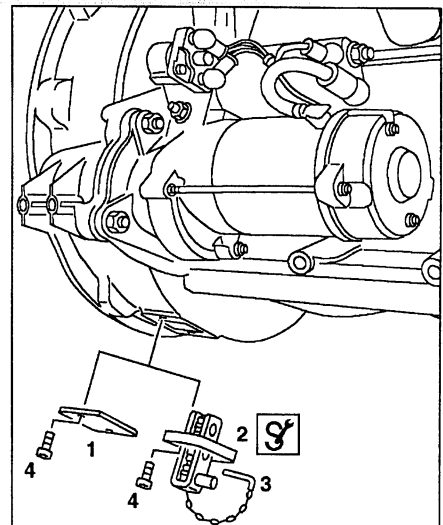



W03.30-0001-02

ENGINE 904.905 /906 /907 /909 /910 /911 /915 /916 /917 /921 /922, 906.910 /911 /915 /916 /919 /920 /921 /922 /923 /925 /926 /927 /928 /939 /942 /943

ENGINE 904.908 /923 in MODEL 668, 670

ENGINE 906.940 /941 /951 /952 in MODEL 957





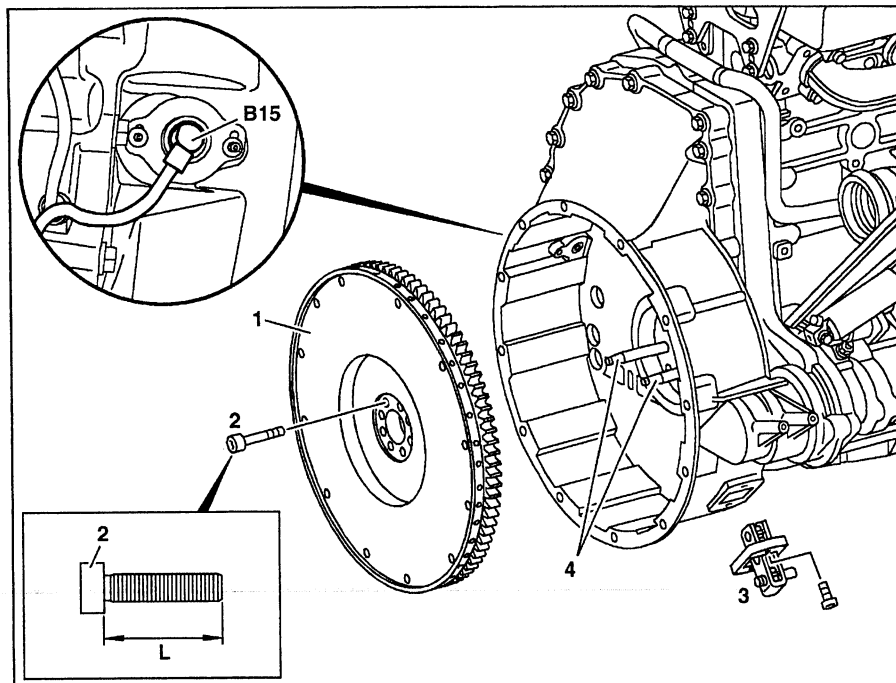

- 1 Flywheel
 2 Flywheel bolt
 3  Cranking and blocking device
 4  Centering drift

B15 Crank angle position sensor

L Shank length of flywheel bolt



W03.30-0018-06

	Removing, installing		
1.1	Remove clutch	<p>If manual transmission with engine 904.905- 907/921</p> <p>If manual transmission with engine 904.909- 911/915- 917/922, 906.910/911/915/916/920- 923/925- 928</p> <p>If manual transmission with engine 906.920- 923/925- 928</p> <p>If manual transmission with engine 904.908/923</p>	<p>AR25.10-W-0050A</p> <p>AR25.10-W-0050C</p> <p>AR25.10-W-0050B</p>
1.2	Remove torque converter	<p>If automatic transmission 723.640/641/ 650/651 with engine 906.940/941/951/952</p> <p>If automatic transmission 723.610/611/613 with engine 906.920- 923/925- 928</p>	AR27.10-W-0500A
2	Pull crank angle position sensor (B15) about 8 mm out of the timing case	<p> Do not damage crank angle position sensor with the ring gear when pulling off the flywheel (1).</p> <p> Installation: Press crank angle position sensor fully into the timing case.</p>	
3	Attach cranking and blocking device (3) to the timing case	<p> Block cranking and blocking device by inserting the pin.</p> <p> Bolt of end cover to timing case.</p> <p></p>	<p>Page 48</p> <p>BA01.60-N-1002-01A</p> <p>904 589 04 63 00</p>
4	Unscrew flywheel bolts (2)	<p> Installation: Oil flywheel bolts lightly and screw tight.</p>	

		Nm ⚙ ⚙	BA03.30-N-1001-01C 904 589 00 10 00 904 589 01 10 00
5	Screw centering drifts (4) into two opposite threaded holes	⚙	904 589 02 63 00
6	Take off cranking and blocking device (3)	⚙	904 589 04 63 00
7	Remove flywheel (1) over the centering drifts (4)	i If flywheel is tight, screw two bolts (M8) into opposite threaded holes and pull off flywheel. i Installation: Grease ring gear with longlife grease.	BR00.45-Z-1001-06A
	Inspecting		
8	Measure flywheel bolts (2)	i If the maximum shank length (L) is exceeded ↓ replace flywheel bolt.	BE03.30-N-1010-03B
9	Inspect clutch surface at flywheel (1)	i If scorch points, scores or cracks are present in the clutch surface ↓ machine flywheel If the scores or cracks are deeper than the maximum permissible stock removal, the flywheel must be replaced.	Page 52 BE03.30-N-1008-03B
10	Inspect flywheel flange for wear and groove caused by the radial seal	i If wear present, replace flywheel.	
11	Inspect ring gear for wear	i If wear present ↓ Replace ring gear.	Page 55
12	Install in the reverse order		

Inspection data of flywheel

Number	Designation		Engine 904 with flywheel ∅ 403 and clutch ∅ 362	Engine 904 with flywheel ∅ 443 and clutch ∅ 362	Engine 904, 906 with flywheel ∅ 443 and clutch ∅ 395	
BE03.30-N-1008-03B	Flywheel - minimum width between friction surface and contact flange for repairs (E)	mm	55	55	55	
		See figure	-	-	-	
BE03.30-N-1010-03B	Flywheel bolts	Thread ∅	M	14×1.5	14×1.5	14×1.5
		Shank length when new	mm	60.0	60.0	60.0
		Shank length	mm	≤61.0	≤61.0	≤61.0

Inspection data of flywheel

Number	Designation	Engine 906 with flywheel Ø 487 and clutch Ø 430
BE03.30-N-1008-03B	Flywheel - minimum width between friction surface and contact flange for repairs (E)	mm 55
		See figure -
BE03.30-N-1010-03B	Flywheel bolts	Thread Ø M 14×1.5
		Shank length when new mm 60.0
		Shank length mm ≤61.0

Nm Timing case

Number	Designation	Engine 904.9, 906.9
BA01.60-N-1002-01A	End cover of inspection hole to timing case	Nm 25

Nm Flywheel, driven plate, vibration damper, starter ring gear

Number	Designation	Engine 904.9, 906.9
BA03.30-N-1001-01C	Bolt of flywheel to crankshaft	M14 1st stage Nm 50
		2nd stage Nm 125
		3rd stage ∠° 90

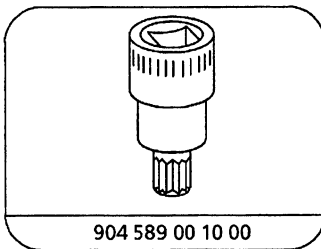

904 589 00 10 00

Screwdriver bit

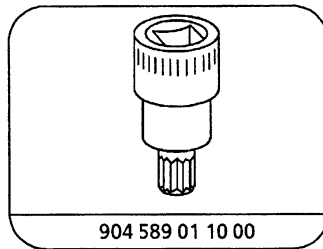

904 589 01 10 00

Screwdriver bit

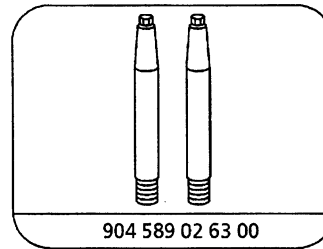

904 589 02 63 00

Aligning punch

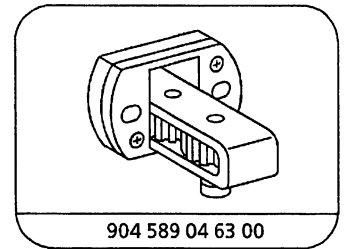

904 589 04 63 00

Cranking device

Repair products

Number	Designation	Order no.
BR00.45-Z-1001-06A	MB long-term grease	000 989 63 51

ENGINE 904.905 /906 /907 /909 /910 /911 /915 /916 /917 /921 /922, 906.910 /911 /915 /916 /919 /920 /921 /922 /923 /925 /926 /927 /928 /939 /942 /943

ENGINE 904.908 /923 in MODEL 668, 670

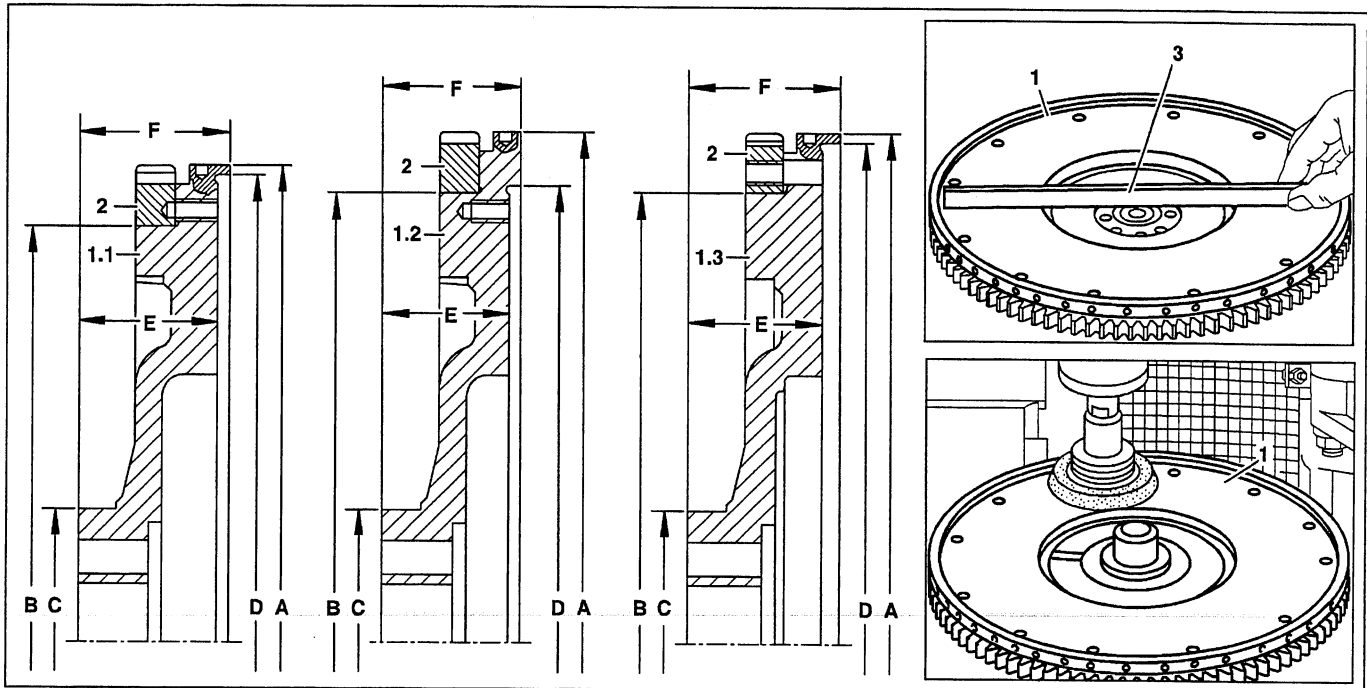

W03.30-0019-09

- 1.1 Flywheel \varnothing 403 (engine 904, with clutch \varnothing 362)
 1.2 Flywheel \varnothing 443 (engine 904, with clutch \varnothing 362)
 1.3 Flywheel \varnothing 443 (engine 906, with clutch \varnothing 395)/
 Flywheel \varnothing 487 (engine 906, with clutch \varnothing 430)
 2 Ring gear
 3 Knife-edge straightedge

- A Flywheel \varnothing
 B Flywheel \varnothing for mounting ring gear
 C Flywheel \varnothing at crankshaft flange
 D Flywheel \varnothing for mounting clutch
 E Flywheel - minimum width between friction surface and mounting flange for repairs
 F Flywheel - overall width

	Removing		
1	Remove flywheel (1)		Page 49
	Inspecting		
2	Clean flywheel (1) and inspect clutch surface (friction surface) for scorch points, scores and cracks and also inspect with a knife-edge straightedge (3) for flatness.	<p> If a complaint exists, the clutch surface (friction surface) must be machined by grinding or precision-turning.</p> <p>If the cracks or scores are so deep that the minimum thickness of the flywheel is not maintained during machining ↓ replace flywheel.</p>	BE03.30-N-1008-03B
	Machining		
3	Machine flywheel (1)	<p>When machining the clutch surface (friction surface), the minimum width of the flywheel (E) between the friction surface and contact surface must be maintained.</p> <p>Flywheel \varnothing for mounting starter ring gear (B)</p>	BE03.30-N-1008-03B BE03.30-N-1002-03B

		Flywheel \varnothing at crankshaft flange (C) Flywheel \varnothing for mounting clutch (D) Hole circle \varnothing for clutch Flywheel overall width (F) <i>i</i> If the peak-to-valley height of the clutch friction surface is excessively large, this increases the wear of the clutch lining. If the the peak-to-valley height is insufficient, this can result in separating problems of the clutch. After machining, there must not be any shrink holes or chatter marks present.	BE03.30-N-1003-03B BE03.30-N-1004-03B BE03.30-N-1005-03B BE03.30-N-1007-03B BE03.30-N-1006-03B
4	Inspect flywheel for roundness and flatness		BE03.30-N-1009-03B
	Installing		
5	Install flywheel (1)		Page 49

Inspection data of flywheel

Number	Designation	Engine 904 with flywheel \varnothing 403 and clutch \varnothing 362	Engine 904 with flywheel \varnothing 443 and clutch \varnothing 362	Engine 904, 906 with flywheel \varnothing 443 and clutch \varnothing 395
BE03.30-N-1002-03B	Flywheel \varnothing for mounting starter ring gear (B) See figure	mm 360.435...360.575 -	392.435...392.575 -	392.435...392.575 -
BE03.30-N-1003-03B	Flywheel \varnothing at crankshaft flange (C) See figure	mm 114.960...115.020 -	114.960...115.020 -	114.960...115.020 -
BE03.30-N-1004-03B	Flywheel \varnothing for mounting clutch (D) See figure	mm 395.000...395.057 -	395.000...395.057 -	435.000...435.063 -
BE03.30-N-1005-03B	Hole circle \varnothing for clutch	mm 375	375	410
BE03.30-N-1006-03B	Peak-to-valley height (R_z) of clutch friction surface	μm 16	16	16
BE03.30-N-1007-03B	Flywheel overall width (F) See figure	mm 64 -	64 -	64 -
BE03.30-N-1008-03B	Flywheel - minimum width between friction surface and contact flange for repairs (E) See figure	mm 55 -	55 -	55 -
BE03.30-N-1009-03B	Flywheel - permissible variation in concentricity and flatness	mm 0.05	0.05	0.05

Inspection data of flywheel

Number	Designation	Engine 906 with flywheel Ø 487 and clutch Ø 430
BE03.30-N-1002-03B	Flywheel Ø for mounting starter ring gear (B) See figure	mm 432.435...432.575 -
BE03.30-N-1003-03B	Flywheel Ø at crankshaft flange (C) See figure	mm 114.960...115.020 -
BE03.30-N-1004-03B	Flywheel Ø for mounting clutch (D) See figure	mm 475.000...475.063 -
BE03.30-N-1005-03B	Hole circle Ø for clutch	mm 450
BE03.30-N-1006-03B	Peak-to-valley height (R _z) of clutch friction surface	µm 16
BE03.30-N-1007-03B	Flywheel overall width (F) See figure	mm 64 -
BE03.30-N-1008-03B	Flywheel - minimum width between friction surface and contact flange for repairs (E) See figure	mm 55 -
BE03.30-N-1009-03B	Flywheel - permissible variation in concentricity and flatness	mm 0.05

ENGINE 904.905 /906 /907 /909 /910 /911 /915 /916 /917 /921 /922, 906.910 /911 /915 /916 /919 /920 /921 /922 /923 /925 /926 /927 /928 /939 /942 /943

ENGINE 904.908 /923 in MODEL 668, 670

- 1 Ring gear
 2.1 Flywheel \varnothing 443 (engine 904, with clutch \varnothing 362)
 2.2 Flywheel \varnothing 403 (engine 904, with clutch \varnothing 362)
 2.3 Flywheel \varnothing 443 (engine 906, with clutch \varnothing 395)/
 Flywheel \varnothing 487 (engine 906, with clutch \varnothing 430)
 A Threaded hole (M10 \times 1.5) for mounting clutch pressure plate
 B Flywheel \varnothing for mounting ring gear

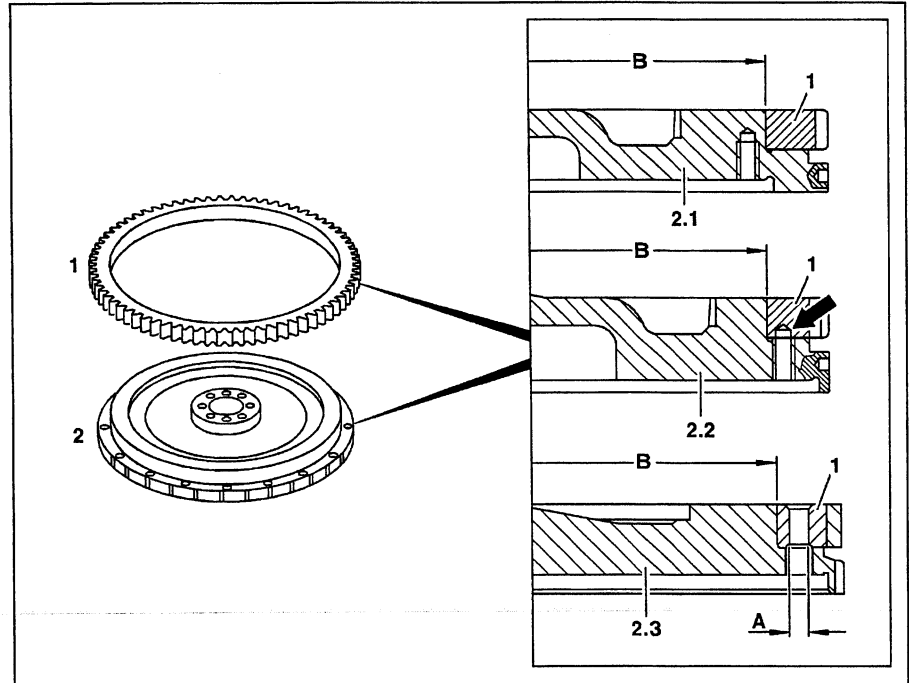

W03.30-0020-06

	Replacing		
Danger!	Risk of injury to skin and eyes from handling hot or glowing objects.	Wear protective gloves, protective clothes and, if necessary, eye protection.	Page 45
1	Remove flywheel		Page 49
2	Heat ring gear rapidly with a welding torch		
3	Press ring gear (1) off the flywheel (2)		
4	Measure flywheel \varnothing (B) for mounting ring gear (1)		BE03.30-N-1002-03B
5	Measure ring gear inner \varnothing of new ring gear	The overlap between ring gear and flywheel must be maintained.	BE03.30-N-1001-04B BE03.30-N-1002-04B
6	Heat new ring gear (1)	The correct temperature is reached once the ring gear has a bright yellow annealing color.	BE03.30-N-1005-04B
7	Press ring gear (1) onto the flywheel (2) as far as the contact surface	The permissible radial runout of the fitted ring gear must not be exceeded. Ring gear width	BE03.30-N-1003-04B BE03.30-N-1004-04B
8	Make threaded holes M10 \times 1.5 (A) in ring gear (1)	Only engine 906 with flywheel \varnothing 443/487 mm.	
9	Install flywheel		Page 49

Inspection data of flywheel

Number	Designation	Engine 904 with flywheel Ø 403 and clutch Ø 362	Engine 904 with flywheel Ø 443 and clutch Ø 362	Engine 904, 906 with flywheel Ø 443 and clutch Ø 395
BE03.30-N-1002-03B	Flywheel Ø for mounting starter ring gear (B)	mm 360.435...360.575	392.435...392.575	392.435...392.575
	See figure	-	-	-

Inspection data of flywheel

Number	Designation	Engine 906 with flywheel Ø 487 and clutch Ø 430
BE03.30-N-1002-03B	Flywheel Ø for mounting starter ring gear (B)	mm 432.435...432.575
	See figure	-





Inspection data of starter ring gear

Number	Designation	Engine 904 with flywheel Ø 403 and clutch Ø 362	Engine 904, 906 with flywheel Ø 443 and clutch Ø 395	Engine 906 with flywheel Ø 487 and clutch Ø 430
BE03.30-N-1001-04B	Starter ring gear inner Ø	mm 359.690...359.830	392.000...392.140	432.000...432.155
BE03.30-N-1002-04B	Starter ring gear/flywheel - overlap	mm 0.885...0.605	0.295...0.575	0.575...0.385
BE03.30-N-1003-04B	Starter ring gear/flywheel - permissible radial runout	mm 0.5	0.5	0.5
BE03.30-N-1004-04B	Starter ring gear - width	mm 15.6...16.0	15.6...16.0	15.6...16.0
BE03.30-N-1005-04B	Starter ring gear - fitting temperature	°C 250...280	250...280	250...280

ENGINE 904.905 /906 /907 /909 /910 /911 /921 /922 ## up to 106313

ENGINE 906.910 /911 /920 /921 /922 /923 ## up to 106161







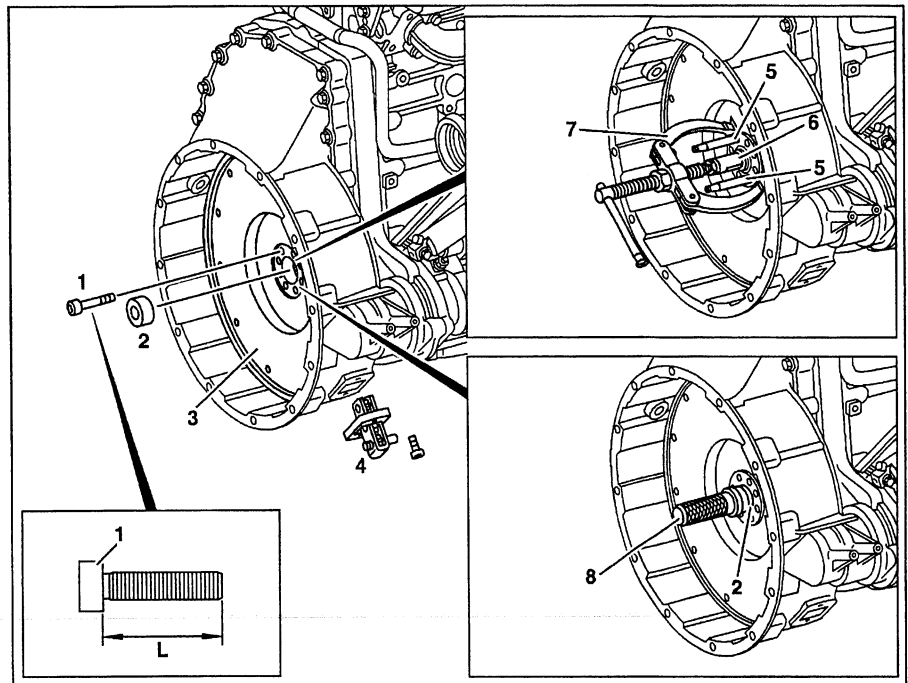



ENGINE 904.908 /923 in MODEL 668, 670

- 1 Flywheel bolt
 2 Guide bearing
 3 Flywheel
 4  Cranking and blocking device
 5  Centering drifts
 6  Internal extractor
 7  Countersupport
 8 Drift

L Shank length of flywheel bolt



W03.30-0021-06

 	Removing, installing		
1	Remove clutch	Manual transmission with engine 904.905-907/ 921 Manual transmission with engine 904.909-911/921/922, 906.910/911/920-923 Manual transmission with engine 906.920-923 Manual transmission with engine 904.908/923	AR25.10-W-0050A AR25.10-W-0050C AR25.10-W-0050B
2	Take off cover at timing case		BA01.60-N-1002-01A
3	Attach cranking and blocking device (4)	 Block cranking and blocking device by inserting the pin.  	Page 48 BA01.60-N-1002-01A 904 589 04 63 00
4	Unscrew flywheel bolts (1)	 Installation: Lightly oil flywheel bolts and tighten fully.  	BA03.30-N-1001-01C 904 589 00 10 00
5	Measure shank length (L) of flywheel bolts (1)	If the maximum shank length is exceeded: ↓ replace flywheel bolt.	BE03.30-N-1010-03B
6	Screw centering drifts (5) into two opposite threaded holes		904 589 02 63 00

7	Remove guide bearing (2)	<p>ⓘ Place bases, e.g. copper plates, below the contact surfaces of the countersupport in order to avoid damaging the flywheel (3).</p> <p>ⓘ</p> <p>ⓘ</p> <p>ⓘ Installation: Use a suitable drift (8) to install new guide bearing (2) flush with the bolt contact surface. Grease guide bearing.</p>	<p>000 589 26 33 00</p> <p>000 589 33 33 00</p> <p>BR00.45-Z-1001-06A</p>
8	Install in the reverse order		

Inspection data of flywheel

Number	Designation			Engine 904 with flywheel ∅ 403 and clutch ∅ 362	Engine 904 with flywheel ∅ 443 and clutch ∅ 362	Engine 904, 906 with flywheel ∅ 443 and clutch ∅ 395
		Thread ∅	M	14×1.5	14×1.5	14×1.5
BE03.30-N-1010-03B	Flywheel bolts	Shank length when new	mm	60.0	60.0	60.0
		Shank length	mm	≤61.0	≤61.0	≤61.0

Inspection data of flywheel

Number	Designation			Engine 906 with flywheel ∅ 487 and clutch ∅ 430
		Thread ∅	M	14×1.5
BE03.30-N-1010-03B	Flywheel bolts	Shank length when new	mm	60.0
		Shank length	mm	≤61.0

Timing case

Number	Designation	Engine 904.9, 906.9
BA01.60-N-1002-01A	End cover of inspection hole to timing case	Nm 25

Flywheel, driven plate, vibration damper, starter ring gear

Number	Designation			Engine 904.9, 906.9
		M14		
BA03.30-N-1001-01C	Bolt of flywheel to crankshaft	1st stage	Nm	50
		2nd stage	Nm	125
		3rd stage	∠°	90

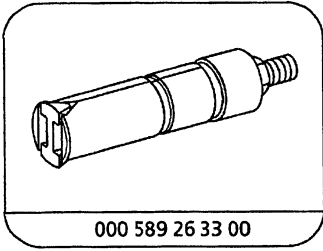

000 589 26 33 00

Internal extractor

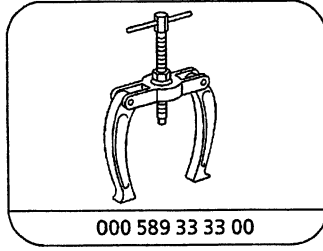

000 589 33 33 00

Countersupport

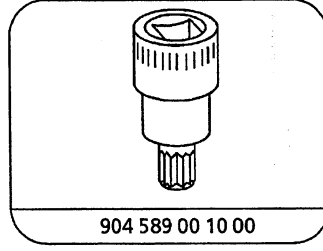

904 589 00 10 00

Screwdriver bit

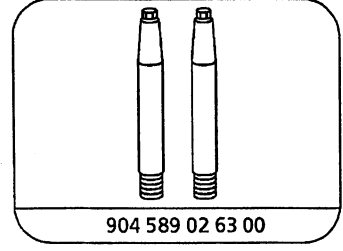

904 589 02 63 00

Aligning punch

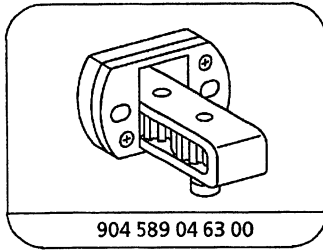

904 589 04 63 00

Cranking device



Repair products

Number	Designation	Order no.
BR00.45-Z-1001-06A	MB long-term grease	000 989 63 51

ENGINE 904.905 /906 /907 /909 /910 /911 /921 /922 /926 /932 ## as of 106314





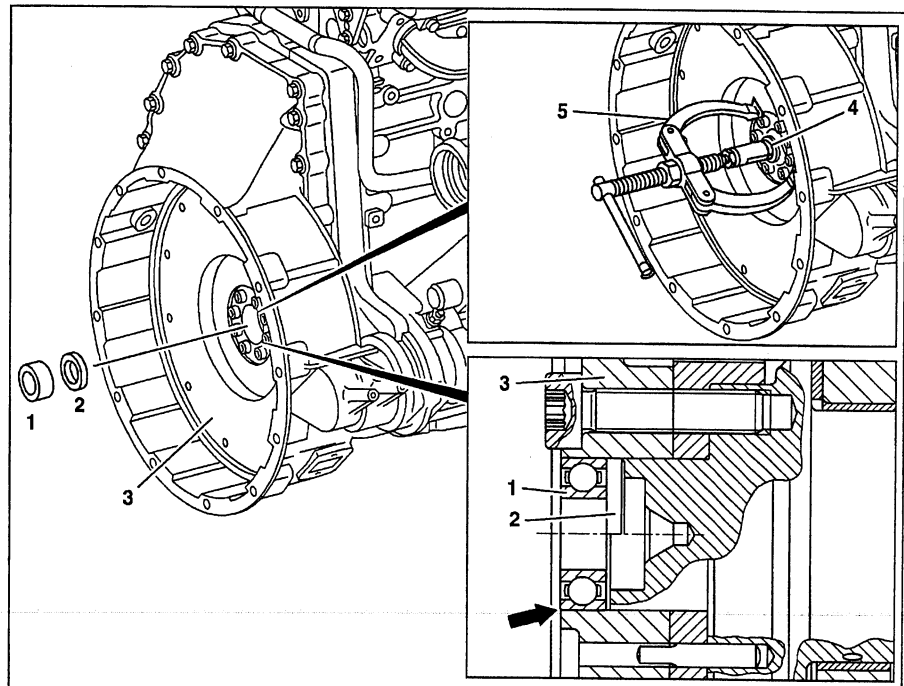

ENGINE 906.910 /911 /920 /921 /922 /923 /929 /932 /933 ## as of 106162

ENGINE 904.915 /916 /917, 906.915 /916 /925 /926 /927 /928 /939 /942 /943

- 1 Guide bearing
 2 Spacer ring
 3 Flywheel
 4  Internal extractor
 5  Countersupport



W03.30-1007-06

	Removing, installing		
1	Remove clutch	Manual transmission with engine 904.905-907/ 921 Manual transmission with engine 904.909-911/915- 917/922, 906.910/911/915/ 916/920- 923/925- 928 Manual transmission with engine 906.920-923/ 925- 928 If manual transmission with engine 904.908/923	AR25.10-W-0050A AR25.10-W-0050C AR25.10-W-0050B
2	Remove guide bearing (1)	<p> If guide bearing (inner $\varnothing 25$) with installed spacer ring: Spacer ring (2) can remain installed in flywheel (3). If the spacer ring (2) was removed, the installation position must be allowed for when installing, the chamfer at the spacer ring points toward the crankshaft.</p> <p> If guide bearing without spacer ring: knock in guide bearing until flush with collar (arrows).</p> <p> Guide bearing with inner $\varnothing 20$ mm.</p> <p> Guide bearing with inner $\varnothing 20$ mm.</p> <p> Guide bearing with inner $\varnothing 25$ mm.</p> <p> Guide bearing with inner $\varnothing 25$ mm.</p>	000 589 26 33 00 000 589 33 33 00 000 589 27 33 00 000 589 34 33 00

3	Grease guide bearing		BR00.45-Z-1001-06A
4	Install in the reverse order		

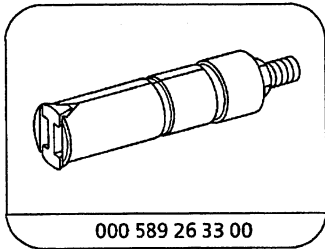

000 589 26 33 00

Internal extractor

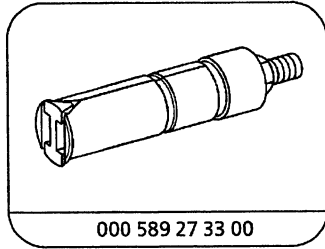

000 589 27 33 00

Internal extractor

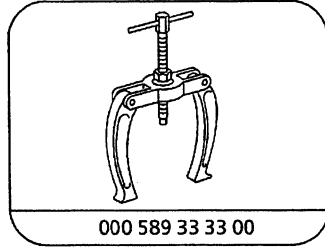

000 589 33 33 00

Countersupport

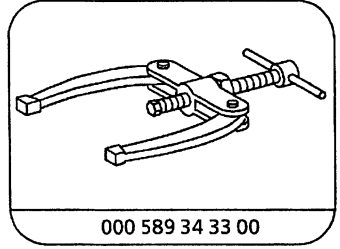

000 589 34 33 00

Countersupport



Repair products

Number	Designation	Order no.
BR00.45-Z-1001-06A	MB long-term grease	000 989 63 51

ENGINE 904.905 /906 /907 /909 /910 /911 /915 /916 /917 /921 /922, 906.910 /911 /915 /916 /919 /920 /921 /922 /923 /925 /926 /927 /928 /939 /942 /943

ENGINE 904.908 /923 in MODEL 668, 670

ENGINE 906.940 /941 /951 /952 in MODEL 957

- 1 Rocker arm
 2 Valve
 3 Tappet rods
 4  Dial gage holder
 5  Dial gage
 6 Valve spring (with valve spring retainer)
 7 Valve bridge

A Valve clearance



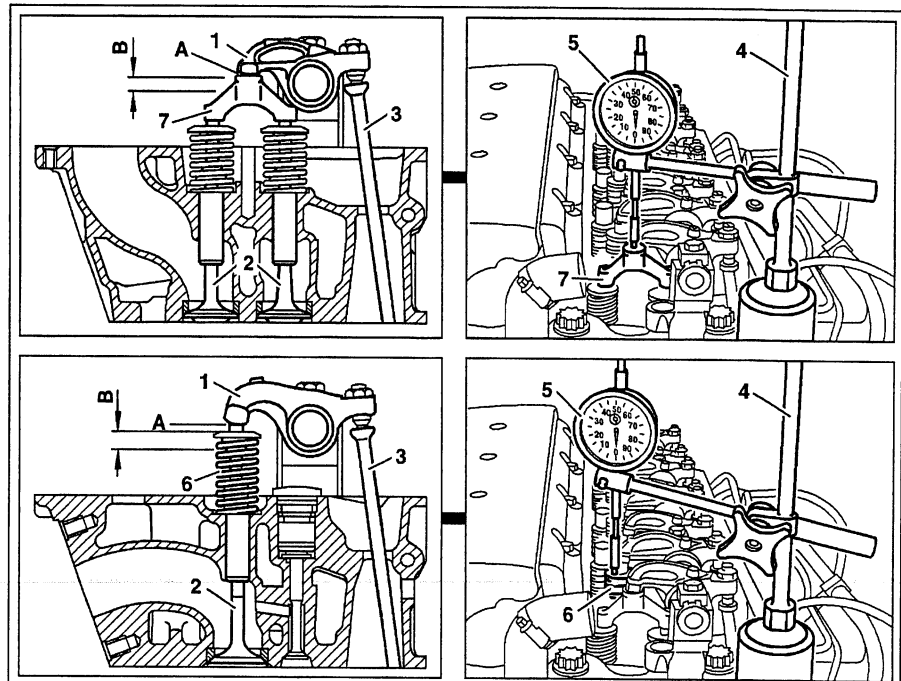



B Valve lift



W05.00-1001-06

Modification notes

7.7.98	Inspection specification of valve lift modified	Step 9	
--------	---	--------	--

	Removing		
1	Remove cylinder head cover		AR01.20-W-5014A
2	Take off cover at timing case		
3	Attach cranking and blocking device	 	Page 48 BA01.60-N-1002-01A 904 589 04 63 00
	Inspecting		
4	Crank engine with the cranking device until the piston of the cylinder to be inspected is positioned at ignition TDC	  The rocker arms (1) of the cylinder to be inspected overlap, it is possible to turn both tappet rods and the valve clearance exists at both rocker arms.	904 589 04 63 00
5	Set valve clearance (A)	Engine 904.905/906/907/921 Engine 904.908/923 Engine 904.909-911/915-917/922 Engine 906.910/911/915/916/919-923/925-928/939/940/941/942/943/951/952	wh0560.30 AP05.30-D-0560A AP05.30-W-0560B
6	Mount dial gage holder (4) and dial gage (5) onto the valve spring retainer of the valve spring (6) of the exhaust valve, or valve bridge (7) of the inlet valve	 Mount dial gage with a preload of approx. 15 mm so that the travel for measuring the valve lift (B) is adequate.	

		☞	001 589 53 21 00
		☞	363 589 02 21 00
N	Set scale of dial gage to "0"	☞	001 589 53 21 00
8	Crank engine fully in direction of rotation with cranking device and read off valve lift (B)	i The maximum valve lift is indicated at the dial gage before the pointer moves back in the opposite direction. The valves (2) are completely opened at this point.	
9	Compare the measurement obtained with the specification	i If the valve lift (B) indicated is less than the specification, inspect cams of the camshaft for wear, if necessary: ↓ Remove camshaft and inspect.	BE05.30-N-1002-01B AR05.20-W-6292A
10	Carry out inspection at all valves (2)		
☒	Installing		
11	Install cylinder head cover		AR01.20-W-5014A
12	Take off cranking and blocking device		Page 48 904 589 04 63 00
13	Install cover at timing case	Nm Bolt of end cover to timing case	BA01.60-N-1002-01A

Inspection data of valves

Number	Designation	Engine 904.9 up to end no. 026066	Engine 904.9 as of end no. 026067, engine 906.9
BE05.30-N-1002-01B	Valve lift at specified valve clearance	Inlet mm ≤ 9.7 Exhaust mm ≤ 10.7	≤ 9.7 ≤ 10.7

Nm Timing case

Number	Designation	Engine 904.9, 906.9
BA01.60-N-1002-01A	End cover of inspection hole to timing case	Nm 25

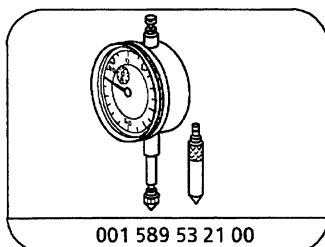

Dial gage

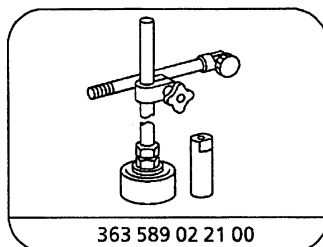

Dial gage holder

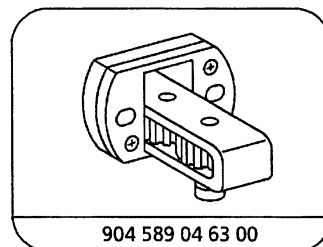

Cranking device

ENGINE 904.905 /906 /907 /908 /921 ## up to 39739

- 1 Cylinder head cover
- 2 Bolt
- 3 Clamping piece
- 4 Rocker arm assembly
- 5 Valve bridge
- 6 Tappet rod
- 7 Guide bolt of valve bridge

A Projection of guide bolt from cylinder head

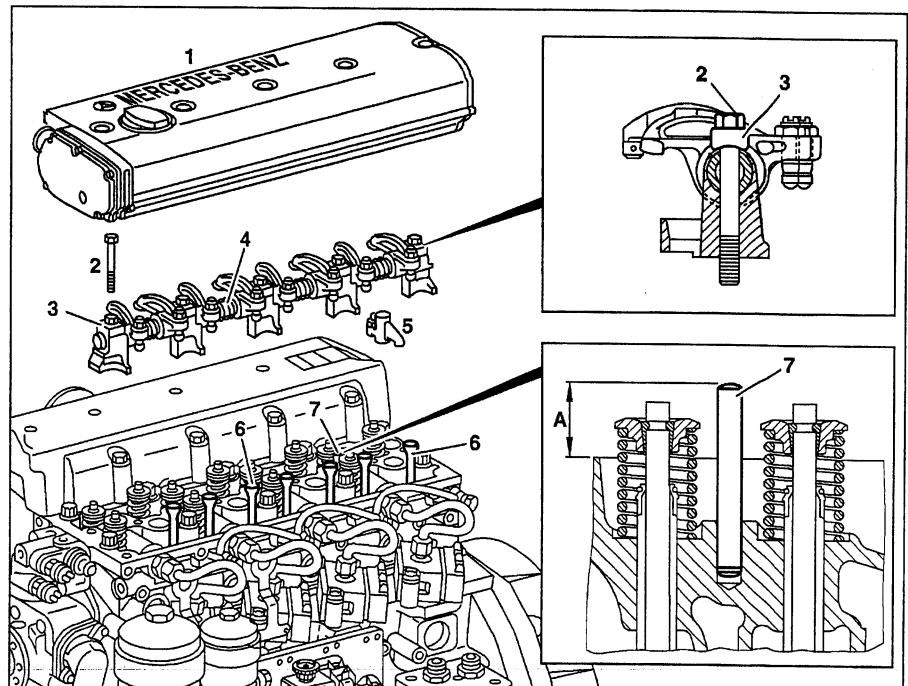

W05.00-0015-06

Modification notes

11.11.97	Tightening torque for rocker arm assembly modified	Step 2	
	Basic setting of valve bridges modified	Step 3	

☒ ☒	Removing, installing		
1	Remove cylinder head cover (1)		AR01.20-W-5014A
2	Remove clamping piece (3) and rocker arm assembly (4)	<p>Inspect rocker arm assembly for wear, if necessary ↓</p> <p>disassemble rocker arm assembly and replace worn parts.</p> <p>i Installation: inspect tappet rods (6) to ensure they are correctly positioned in the tappets. Oil tappet rod sockets (6) with engine oil.</p> <p>Nm Bolt of rocker arm assembly to cylinder head</p>	<p>Page 69</p> <p>BA05.00-N-1001-01A</p>
3	Take off valve bridges (5)	<p>Mark valve bridges and inspect for wear, if necessary ↓</p> <p>replace valve bridges.</p> <p>i Installation: if the valve seat rings in the cylinder head or the valves were machined, the valve bridges have to be adjusted.</p> <p>Adjust valve bridges.</p> <p>⚠ The valve bridges must not be locked in the basic setting when they are installed.</p>	Page 65

		 Locking nut at adjusting screw of valve bridge	BA05.00-N-1003-01A
4	Measure projection (A) of guide bolts (7) from cylinder head	If dimensional differences exist ↓ withdraw guide bolt and replace	BE05.30-N-1003-04B
5	Install in the reverse order		
6	Set valve clearance	Engine 904.905/906/907/921 Engine 904.908	wh0560.30 AP05.30-D-0560A

Test data of valve timing

Number	Designation	Engine 904.9, 906.9
BE05.30-N-1003-04B	Valve bridge guide bolt projection from cylinder head (A)	mm 25.1–25.5
	Fig. see	–

Engine timing, general

Number	Designation	Engine 904.9, 906.9
BA05.00-N-1001-01A	Bolt of rocker arm assembly to cylinder head	Nm 30
BA05.00-N-1003-01A	Locking nut at adjusting screw of valve bridge	Nm 25

AR05.00-W-5521-02B	Adjusting valve bridge		
--------------------	------------------------	--	--

Modification notes

11.11.97	Basic setting of valve bridges modified	Steps 1 to 8	
----------	---	--------------	--

Engine timing, general

Number	Designation	Engine 904.9, 906.9
BA05.00-N-1002-01A	Locking nut to adjusting screw of rocker arm	Nm 25
BA05.00-N-1003-01A	Locking nut to adjusting screw of valve bridge	Nm 25



Carry out setting of valve bridges (3) only when engine is cold or thoroughly warmed through. Wait at least 30 minutes after switching off the engine.

- 1 Clamp valve bridges (3) in a vise, slacken locking nut (1) and unscrew adjusting screw (2) about 3 turns.

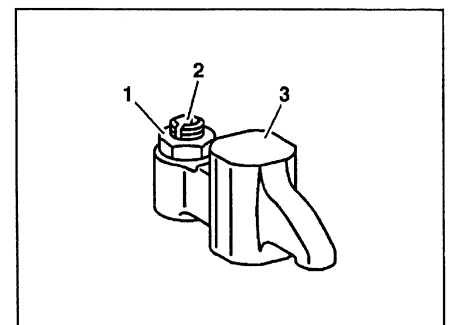

W05.00-0012-01

- 2 Install valve bridges (3) over the guide bolts on the cylinder head.
- 3 Press valve bridge (3) down. Valve bridge (3) should be making contact with valve stem (arrow A).
- 4 With valve bridge (3) pressed down, screw in adjusting screw (2) by hand until the adjusting screw (2) makes slight contact with the valve stem (arrow B).



Valve bridge (3) must not move up.

- 5 Screw on locking nut (1) by hand until it makes contact.
- 6 Take off valve bridges (3) at the cylinder head.
- 7 Clamp valve bridges (3) in a vise, tighten adjusting screw (2) and locking nut (1) to specified torque.
- 8 Install valve bridges (3) over the guide bolt on the cylinder head.

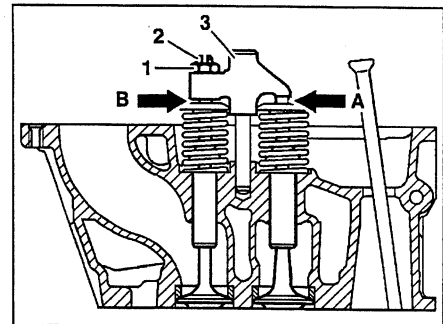

W05.00-0013-01

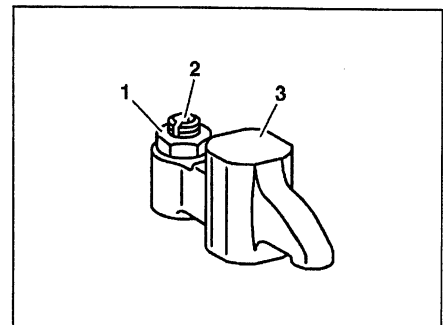

W05.00-0012-01



ENGINE 904.905 /906 /907 /908 /921 ## as of 039740

ENGINE 904.909 /910 /911 /915 /916 /917 /922 /923, 906.910 /911 /915 /916 /919 /920 /921 /922 /923 /925 /926 /927 /928 /939 /940 /941 /942 /943 /951 /952

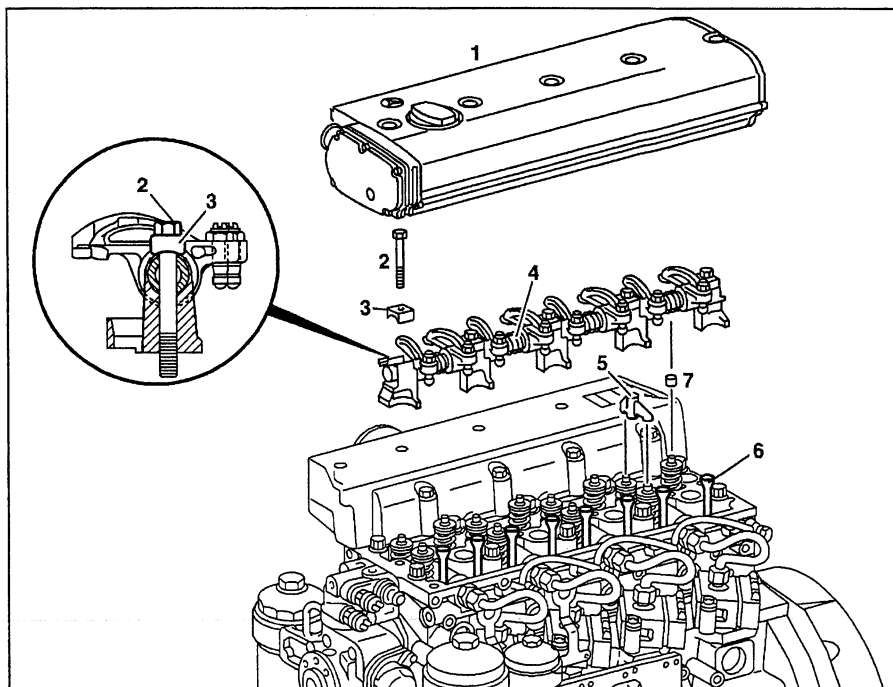
- 1 Cylinder head cover
- 2 Bolt
- 3 Clamp
- 4 Rocker arm assembly
- 5 Valve bridge
- 6 Tappet rod
- 7 Cap



W05.00-1003-06

	Removing, installing		
1	Remove cylinder head cover (1)		AR01.20-W-5014A
2	Remove clamp (3) and rocker arm assembly (4)	<p>Inspect rocker arm assembly for wear, if necessary: ↓</p> <p>Disassemble rocker arm assembly and replace worn parts.</p> <p> Installation: Ensure tappet rods (6) are correctly located in the tappets. Oil tappet rod sockets (6) with engine oil.</p> <p></p>	<p style="text-align: right;">Page 69</p> <p>BA05.00-N-1001-01A</p>
3	Take off caps (7) at the exhaust valve stem ends		
4	Take off valve bridges (5) at the inlet valves	<p>Inspect valve bridges for wear if necessary: ↓</p> <p>Replace valve bridges.</p>	
5	Install in the reverse order		
6	Set valve clearance	<p>Engine 904.905-907/909-911/915-917/921/922</p> <p>Engine 906.910/911/915/916/919-923/925-928/939/940/941/942/943/951/952</p> <p>Engine 904.908/923</p>	<p>AP05.30-W-0560B</p> <p>AP05.30-D-0560A</p>

Nm Engine timing - general

Number	Designation	Engine 904.9, 906.9
BA05.00-N-1001-01A	Bolt of rocker arm assembly to cylinder head	Nm 30

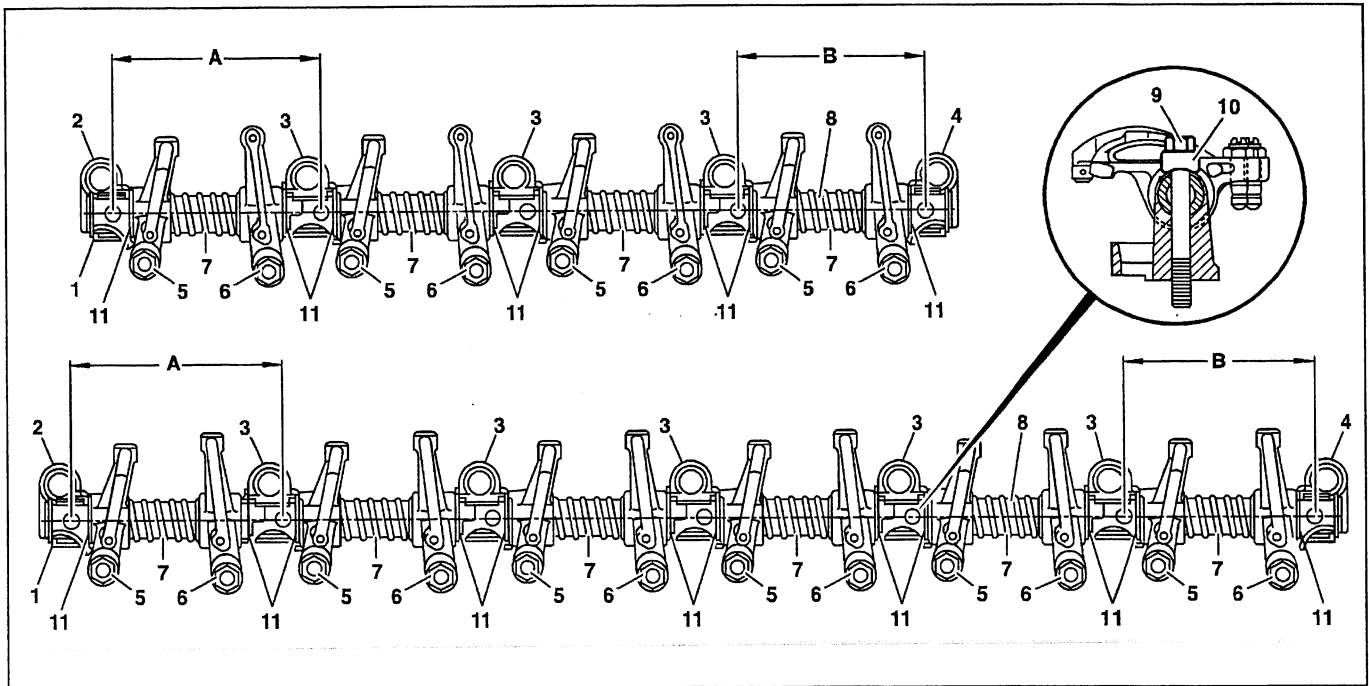

ENGINE 904.905 /906 /907 /908 /909 /910 /911 /915 /916 /917 /921 /922 /923, 906.910 /911 /915 /916 /919 /920 /921 /922 /923 /925 /926 /927 /928 /939 /940 /941 /942 /943 /951 /952



W05.00-0014-09

- | | | | |
|---|----------------------------------|----|------------------|
| 1 | Circlip | 8 | Rocker arm shaft |
| 2 | Rocker arm bracket (front outer) | 9 | Screws |
| 3 | Rocker arm bracket (inner) | 10 | Clamp |
| 4 | Rocker arm bracket (rear outer) | 11 | Washer |
| 5 | Rocker arm (inlet) | | |
| 6 | Rocker arm (exhaust) | A | Clearance 122 mm |
| 7 | Spring | B | Clearance 110 mm |

	Removing		
1	Remove rocker arm assembly	Engine 904.905-908/921 up to end no. 039739 Engine 904.905-908/921 as of end no. 039740 904.909-911/915-917/922/923, 906.910/911/915/916/919-923/925-928/ 939/940/941/942/943/951/952	Page 64 Page 67
	Disassembling		
2	Remove circlips (1)		
3	Take rocker arm brackets (2, 3, 4), rocker arms (5, 6), washers (11) and springs (7) off the rocker arm shaft (8)	Inspect parts of rocker arm assembly for wear, if necessary: ↓ Replace parts. Rocker arm bearing bush inner Ø Rocker arm shaft Ø	BE05.30-N-1001-04B BE05.30-N-1002-04B
	Assembling		

4	Install circlip (1) at one side of the rocker arm shaft (8), assemble rocker arm assembly in the reverse order and secure with the circlip (1)	 Pay attention to installation position of the outer rocker arm bracket (2, 4) and rocker arm brackets (3). Fix rocker arm bracket (2, 3, 4) in place with the bolts (9) and the clamps (10). Pay attention to clearance of holes of outer rocker arm bracket (2, 4) relative to the inner rocker arm bracket (3). Dimension "A" 122 mm Dimension "B" 110 mm	
	Installing		
5	Install rocker arm assembly	Engine 904.905-908/921 up to end no. 039739 Engine 904.905-908/921 as of end no. 039740 904.909-911/915-917/922/923, Engine 906.910/911/915/916/919-923/ 925-928/939/940/941/942/943/951/952	Page 64 Page 67





Inspection data of valve timing

Number	Designation	Engine 904.9, 906.9
BE05.30-N-1001-04B	Rocker arm bearing bush inner Ø when installed	mm 22.000-22.021
BE05.30-N-1002-04B	Rocker arm shaft Ø	mm 21.967-21.980

ENGINE 904.905 /906 /907 /909 /910 /911 /915 /916 /917 /921 /922, 906.910 /911 /915 /916 /919 /920 /921 /922 /923 /925 /926 /927 /928 /939 /942 /943



ENGINE 904.908 /923 in MODEL 668, 670

ENGINE 906.940 /941 /951 /952 in MODEL 957

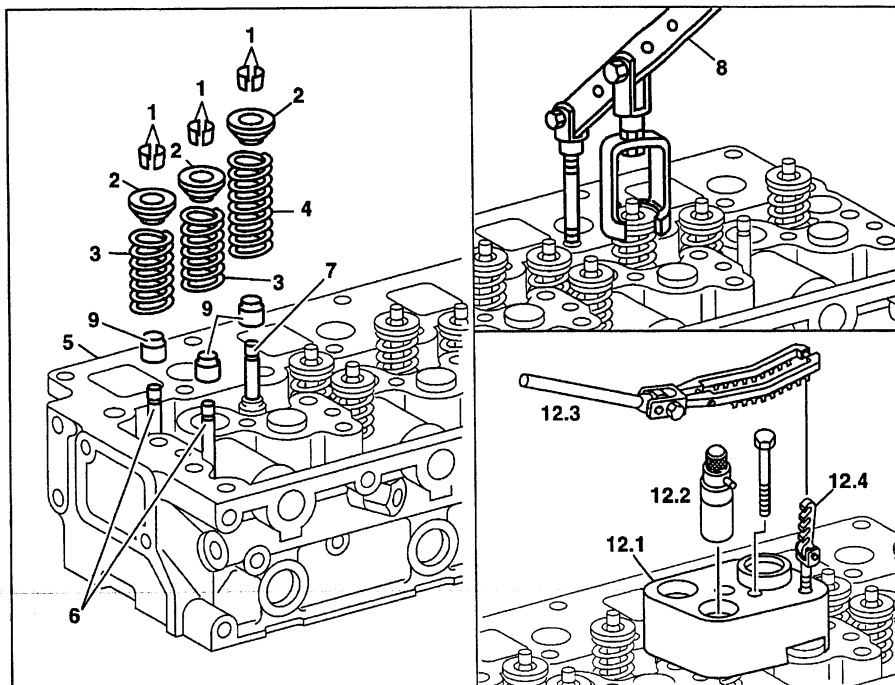
- 1 Collet
- 2 Valve spring plate
- 3 Inlet valve spring
- 4 Exhaust valve spring
- 5 Cylinder head
- 6 Inlet valve
- 7 Exhaust valve
- 8  Valve lifter with extra piece
- 9 Valve stem seal
- 12.1  Base plate
- 12.2  Assembly cartridge
- 12.3  Pressure fork
- 12.4  Holder fork



W05.30-1017-06





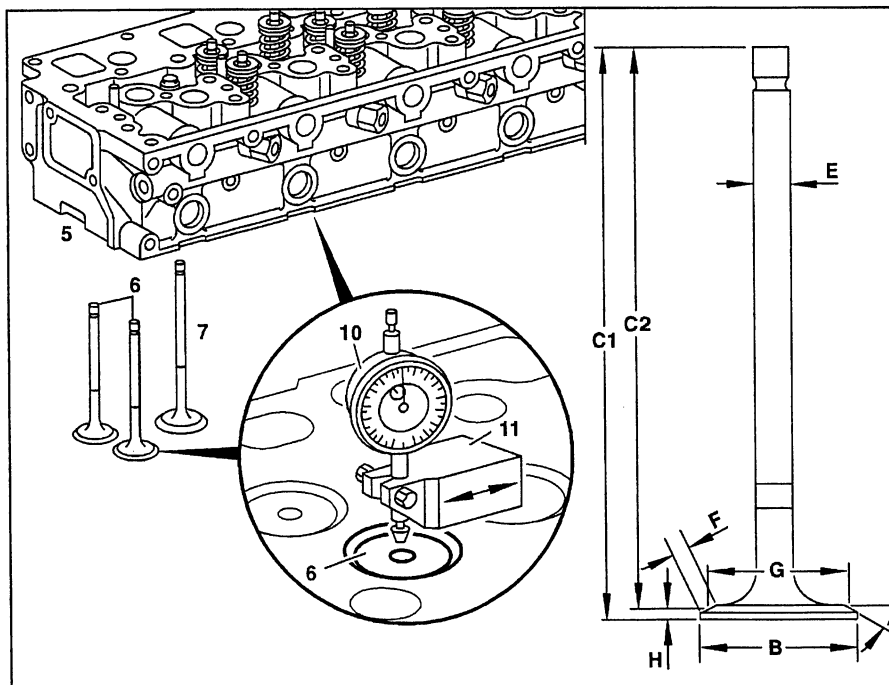











- 5 Cylinder head
- 6 Inlet valve
- 7 Exhaust valve
- 10  Dial gauge
- 11  Dial gauge holder









- A Valve seat angle
- B Valve head dia.
- C1 Valve length (engine 904.905- 908/921 up to final no. 039739)
- C2 Valve length (engine 904.905-908/921 from final no. 039740, 904.909- 911/915- 917/922/923, 906.910/911/915/916/919- 923/925-928/939/940/941/942/943/951/952)
- E Valve stem dia.
- F Valve seat width on valve disk
- G Valve seat face dia.
- H Valve seat surface machining dimension related to valve seat surface diameter



W05.30-0064-06

	Removing, installing		
1	Remove cylinder head (5)	Engine 904.905- 907/909- 911/915-917/921/922 and Engine 906.910/911//915/916/920-923/925- 928/940/941/942/943/951/952	AR01.30-W-5800A

		Engine 904.908/923	AR01.30-D-5800D
2	Remove nozzle holder combination	Engine 904.905- 908/921 up to final no. 040487 Engine 904.905- 908/921 from final no. 040488 904.909- 911/915- 917/922/923 Engine 906.910/911/915/916/919- 923/ 925-928/939/940/941/942/943/951/952	AR07.03-W-6831A AR07.03-W-6831C
3.1	Measure valve set-back (B) to cylinder head	Engine 904.905- 908/921 up to final no. 039739 Measure and note valve set-back on both inlet valves and the exhaust valve.    If the test value measured does not lie within the permissible tolerance: ↓ Machine valve seat rings.	Page 76 BE05.30-N-1001-01B 001 589 53 21 00 343 589 00 40 00 AR05.30-W-4511A
3.2	Measure valve set-back (B) to cylinder head and permissible difference between both inlet valve stems.	Engine 904.905- 908/921 from final no. 039740 904.909- 911/915- 917/922/923, Engine 906.910/911/915/916/919- 923/925- 928/939/940/941/942/943/951/952 Measure and note valve set-back on both inlet valves and the exhaust valves. The permissible difference between both inlet valve stem ends must not be exceeded.     If the measurements obtained are not within the permissible tolerance: ↓ Machine valve seat rings.	Page 77 BE05.30-N-1001-01B BE05.30-N-1014-01B 001 589 53 21 00 363 589 02 21 00 343 589 00 40 00 AR05.30-W-4511A
4	Remove valve spring retainer (2) and valve springs (3, 4)	 Removal using valve lifter      Removal using assembly cartridge 	Page 78 210 589 00 40 00 442 589 00 31 00 904 589 00 31 00 WH58.30-Z-1001-14A Page 79 541 589 00 61 00
5	Pull valves (6, 7) out of cylinder head	 Mark valves.	
6	Pull off valve stem seals (9)	 Installation: Replace valve stem seals.	Page 87
7	Check valve seat rings	Measure valve seat width on all valve seat rings. Measure valve set-back on both inlet valves and the exhaust valves.	BE05.30-N-1007-03B BE05.30-N-1001-01B

		<p> If the valve seats are only lightly pitted, they can be reworked without renewing the valve seat rings provided the valve set-back is not exceeded.</p> <p> With engine 904.905- 908/921 from final no. 039740 904.909- 911/915- 917/922/923, 906.910/911/915/916/919- 923/925- 928/ 939/940/941/942/943/951/952, the difference between the two inlet valve stem ends must not be exceeded, if necessary.: ↓</p> <p>Machine valve seat rings.</p>	<p>BE05.30-N-1014-01B</p> <p>AR05.30-W-4511A</p>
8	Check valve guides for wear using the measuring probe	<p></p> <p> If the end of the measuring probe marked " + " can pass into the valve guide: ↓ replace valve guide.</p>	<p>102 589 00 23 00</p> <p>BE05.30-N-1003-02B</p> <p>BE05.30-N-1006-02B</p> <p style="text-align: right;">Page 82</p>
9	Inspect whether valves (6, 7) can be re-used	<p> The valve stem ends must have no surface damage. The collet grooves must not be pitted and the chrome layer on the valve stems must be complete. Valve seats must not be burnt .</p> <p> Hardness tester</p> <p>Check hardness of valve stem ends, if necessary: ↓</p> <p>Grind or replace valves.</p>	<p>000 589 20 21 00</p> <p>BE05.30-N-1010-01B</p> <p>AR05.30-W-4202A</p>
10	Inspect concentricity and dimensional tolerance of valves (6, 7)	<p>Concentricity of valve seat to valve stem.</p> <p>Valve seat angle (a)</p> <p>Valve disk dia. (B)</p> <p>Valve length (C)</p> <p>Valve seat width on valve disk (F)</p> <p>Valve stem dia. (E)</p> <p>Inlet valve seat face machining dimension (H) with reference to valve seat face dia. (G).</p> <p>Exhaust valve seat face machining dimension (H) with reference to valve seat face dia. (G).</p> <p> Micrometer</p> <p> It is not permissible to straighten the valves.</p> <p>Slight deviations in concentricity can be corrected by refacing the valve seat on a valve grinding machine.</p>	<p>BE05.30-N-1011-01B</p> <p>BE05.30-N-1003-01B</p> <p>BE05.30-N-1004-01B</p> <p>BE05.30-N-1006-01B</p> <p>BE05.30-N-1005-01B</p> <p>BE05.30-N-1007-01B</p> <p>BE05.30-N-1008-01B</p> <p>BE05.30-N-1009-01B</p> <p>WH58.30-Z-1005-12A</p> <p>AR05.30-W-4202A</p>
11	Inspect valve springs (3, 4)	<p> Replace damaged valve springs.</p>	

12	Install in the reverse order		
13	Measure the valve set-back (B) again on the reworked valves (6,7) and, if necessary, measure the permissible difference between the two inlet valve stems	<p>Engine 904.905- 908/921 up to final no. 039739</p> <p>Engine 904.905- 908/921 from final no. 039740 904.909- 911/915- 917/922/923, Engine 906.910/911/915/916/919- 923/925- 928/939/940/941/942/943/951/952</p> <p> If the test value measured does not lie within the permissible tolerance: ↓</p> <p>Check valve seat on both inlet valves or on exhaust valve.</p>	<p>Page 76</p> <p>Page 77</p>

Inspection data of valves

Number	Designation		Engine 904.9 up to final no. 026066	Engine 904.9 from final no. 026067, Motor 906.9
BE05.30-N-1001-01B	Valve set-back to cylinder head contact surface	mm	1.1-1.5	1.1-1.5
BE05.30-N-1003-01B	Valve seat angle (a)	inlet	\sphericalangle ° 20	20
		Exhaust	\sphericalangle ° 45	45
BE05.30-N-1004-01B	Valve head dia. (B)	inlet	mm 33.9-34.1	33.9-34.1
		exhaust	mm 37.9-38.1	37.9-38.1
BE05.30-N-1005-01B	Valve seat width on valve head (F)	inlet	mm 3.3-4.3	3.3-4.3
		exhaust	mm 3.5-4.2	3.5-4.2
BE05.30-N-1006-01B	Valve length (C)	inlet	mm 125.7-126.1	125.65-126.95
		Exhaust	mm 152.5-152.9	152.5-152.9
BE05.30-N-1007-01B	Valve stem dia. (E)	inlet	mm 7.935-7.950	7.935-7.950
		Exhaust	mm 7.925-7.940	7.925-7.940
BE05.30-N-1008-01B	Inlet valve seat face machining dimension (H) with reference to valve seat face dia. (G)	Dimension G	mm 31.0	31.0
		Dimension H	mm 2.7-3.1	2.7-3.1
BE05.30-N-1009-01B	Exhaust valve seat face machining dimension (H) with reference to valve seat face dia. (G)	Dimension G	mm 36.0	36.0
		Dimension H	mm 2.5-3.2	2.5-3.2
BE05.30-N-1010-01B	Hardness of valve stem end	inlet	HR. 54-60	54-60
		Exhaust	HR. 54-60	54-60
BE05.30-N-1011-01B	Concentricity of valve seat to valve stem	inlet	mm 0.03	0.03
		Exhaust	mm 0.03	0.03
BE05.30-N-1014-01B	Permissible difference of inlet valves measured between cylinder head and valve stem end	mm	0.2	0.2

Test values for valve guides

Number	Designation	Engine 904.905/906/907/921	Engine 904.908
BE05.30-N-1003-02B	Internal dia. (machining dimension) (B)	mm	8.000-8.022
		See figure	-
BE05.30-N-1006-02B	Play of valve stem	inlet mm	0.050-0.087
		Exhaust mm	0.060-0.097

Test values for valve guides

Number	Designation	Engine 904.909/910/911/915/916/917/922, 906.910/911/915/916/919/920/921/922/923/925/926/927/928/939/940/941/951/952	
BE05.30-N-1003-02B	Internal dia. (machining dimension) (B)	mm	8.000-8.022
		See figure	-
BE05.30-N-1006-02B	Play of valve stem	inlet mm	0.050-0.087
		Exhaust mm	0.060-0.097

Test data of valve seat rings

Number	Designation	Engine 904.9, 906.9	
BE05.30-N-1007-03B	Valve seat width on valve seat ring (F)	inlet mm	1.5-2.5
		Exhaust mm	1.8-3.0
		See figure	-

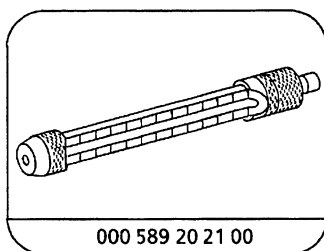

Hardness tester

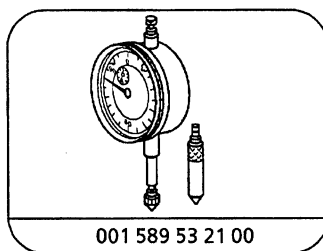

Dial gage

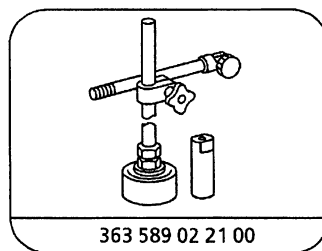

Dial gage holder

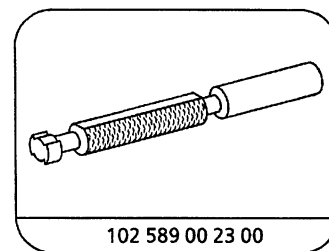

Drift

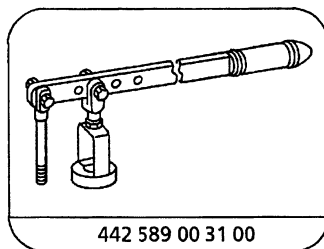

Valve lifter

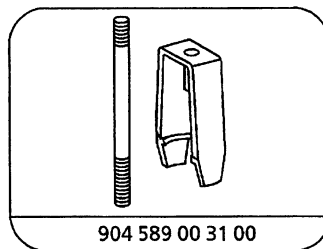

Adapter piece

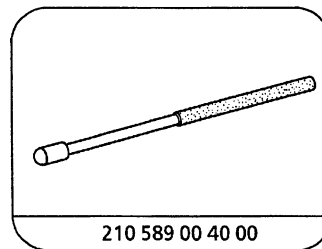

Magnet pin

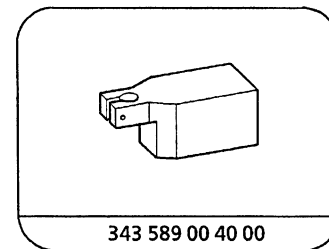

Dial gage holder

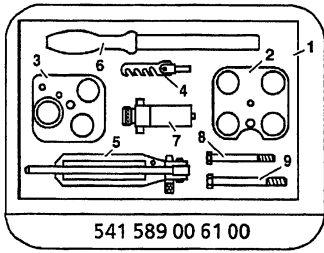

541 589 00 61 00

Valve tool case

Commercially available tools (see Workshop Equipment Manual)

Number	Designation	Make (e. g.)	Order no.
WH58.30-Z-1005-12A	Micrometer 0 - 25 mm	Hahn and Kolb Borsigstr. 50 D-70469 Stuttgart	31 400 002
WH58.30-Z-1001-14A	Cylinder head holding fixture	Type K2000 Hunger D-81309 München	221 00 200

AR05.30-W-4100-01A	Measuring amount by which valve stands back to cylinder head		
--------------------	--	--	--

Test data of valves

Number	Designation	Engine 904.9 up to end no. 026066	Engine 904.9 as of end no. 026067, engine 906.9
BE05.30-N-1001-01B	Amount by which valve stands back relative to cylinder head contact surface	mm 1.1-1.5	1.1-1.5

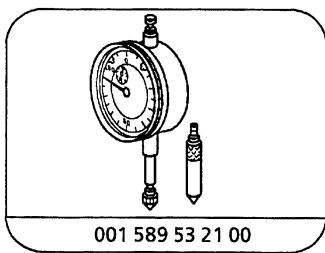

001 589 53 21 00

Dial gage

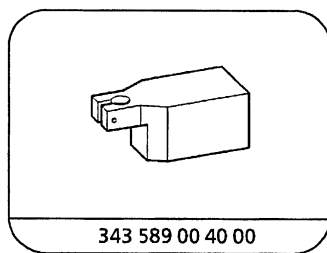

343 589 00 40 00

Dial gage holder



Valve disk (3) should be making contact with valve seat.

- 1 Attach dial gage (1) to dial gage holder (2).
- 2 Mount dial gage (1) with a preload onto the plane face of the cylinder head.
- 3 Set scale of dial gage to "0".
- 4 Move dial gage (1) sufficiently until the tracer pin is touching the valve disk (3).

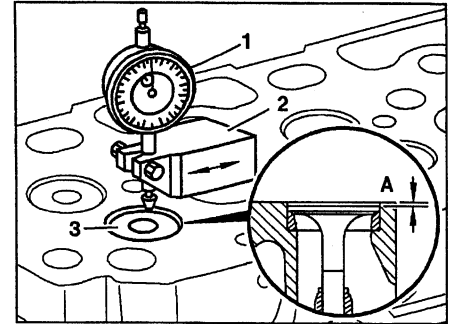

W05.30-0060-01



If the reading obtained (A) is not within the permissible tolerance, inspect valve seat ring or the valve disk.

AR05.30-W-4100-01C	Measuring amount by which valve stands back to cylinder head		
--------------------	--	--	--

Inspection data of valves

Number	Designation		Engine 904.9 up to end no. 026066	Engine 904.9 as of end no. 026067, engine 906.9
BE05.30-N-1001-01B	Valve setback to cylinder head contact surface	mm	1.1-1.5	1.1-1.5
BE05.30-N-1014-01B	Permissible difference of inlet valves measured between cylinder head and valve stem end	mm	0.2	0.2

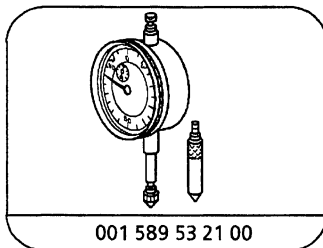

Dial gage

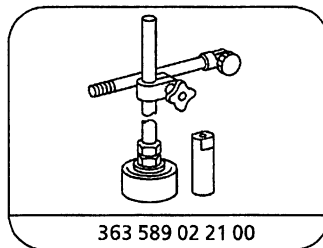

Dial gage holder

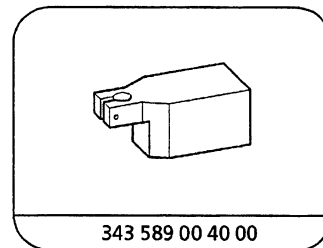

Dial gage holder

The valve disk (3) must be resting against the valve seat.



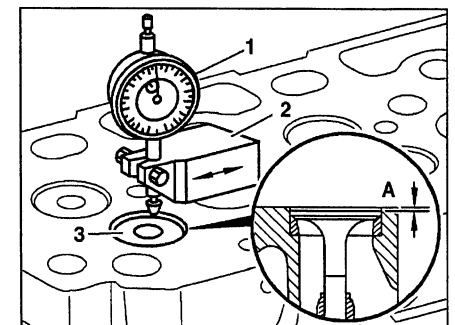

- 1 Attach dial gage (1) to dial gage holder (2).
- 2 Mount dial gage (1) with a preload on the plane face of the cylinder head.
- 3 Set scale of dial gage to "0".
- 4 Move dial gage (1) sufficiently so that the tracer pin is positioned on the valve disk (3).



W05.30-0060-01



If the inspection reading obtained (A) is not within the permissible tolerance, inspect the valve seat ring or the valve disk.

- 5  Attach dial gage (1) to  dial gage holder (4) and mount on the top contact surface of the cylinder head.
- 6  Mount dial gage (1) with a preload onto one of the two inlet valve stem ends (5).
- 7 Set scale of dial gage to "0".
- 8 Pull back tracer pin at  dial gage (1). Mount dial gage (1) onto the other inlet valve stem end (5) and take reading.

 Permissible difference (C) between both inlet valve stem ends (5) must not be exceeded.

If the reading obtained (C) is not within the permissible tolerance, inspect the valve seat ring or the valve.

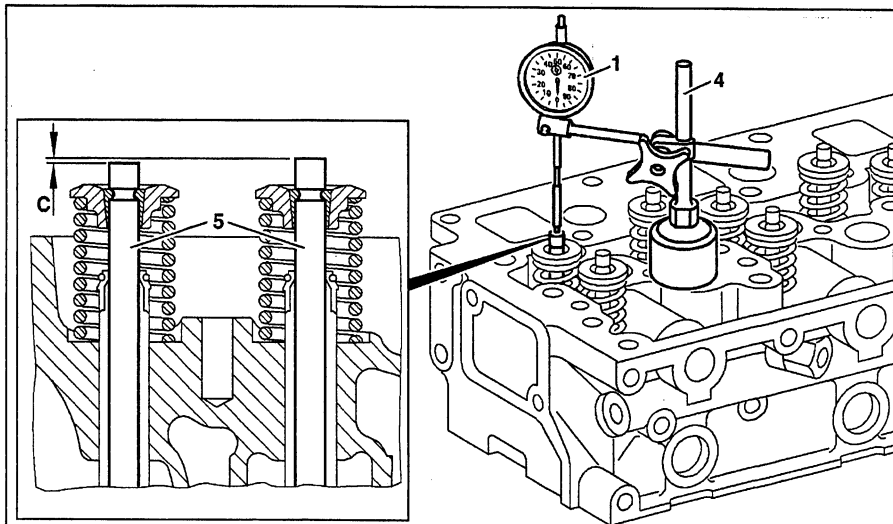

W05.30-0058-05

AR05.30-W-3510-03A	Removing and installing engine timing system		
--------------------	--	--	--

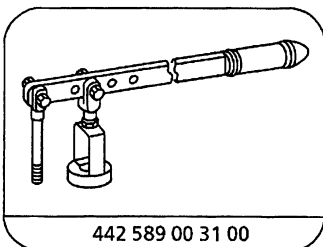

442 589 00 31 00

Valve lifter

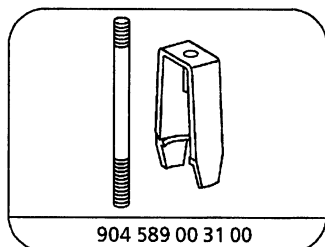







904 589 00 31 00

Adapter piece

Commercially available tools (see Workshop Equipment Manual)

Number	Designation	Make (e. g.)	Order no.
WH58.30-Z-1001-14A	Cylinder head holding fixture	Type K2000 Hunger D-81309 München	221 00 200

Removing

- 1 Place cylinder head on a flat surface or attach to the  cylinder head holding fixture.
- 2  Attach valve lifter (1) with  adapter piece (2) and  stud bolt (3).
- 3 Press down valve spring retainer (5) with valve lifter (1) and take off collets (4) with the  magnetic pin.
 Counterhold valve at the valve disk.
- 4 Relieve pressure on valve lifter (1), take off valve spring retainer (5) and valve springs (6).
 Inspect valve spring retainers (5) and collets (4) for wear, replace if necessary.

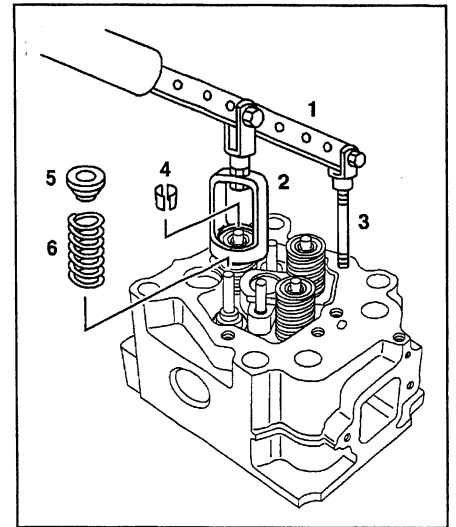

W05.30-1013-02

Installing

- 5 Press down valve spring retainer (5) with valve lifter (1) and insert collets (4) into the slot of the valve stem.
- 6 Inspect whether the collets (4) are reliably installed; repeat steps 3 to 6, if necessary.



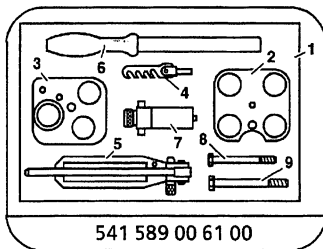



AR05.30-W-3510-03B	Removing and installing engine timing system		
--------------------	--	--	--



541 589 00 61 00

Valve tool case

Removing

- 1 Place cylinder head on a flat surface.
 - 2  Position base plate (1) over the valve group to be removed and screw tight to cylinder head.
 - 3  Screw in retaining fork (3) at the base plate (1).
 - 4 Open lever handle at the  thrust fork (4) and secure with bolt.
 - 5  Insert assembly cartridge (5) into the guide bush of the base plate (1), attach thrust fork (4) to the retaining fork (3) and position against the mounting bolts of the assembly cartridge (5).
 - 6 Apply light pressure to thrust fork (4) and to assembly cartridge (5), while at the same time slowly turning the knurled screw of the assembly cartridge (5) (arrows) until the internal locating drift with its tips is felt to engage between the collets.
 - 7 Press down thrust fork (4) as far as the stop (use  extension if necessary). The collets are removed automatically.
-  When this procedure is performed, the collets are pressed into the assembly cartridge (5) and held tight by it.
- 8 Carefully release pressure and valve spring with thrust fork (4) and take off thrust fork (4).

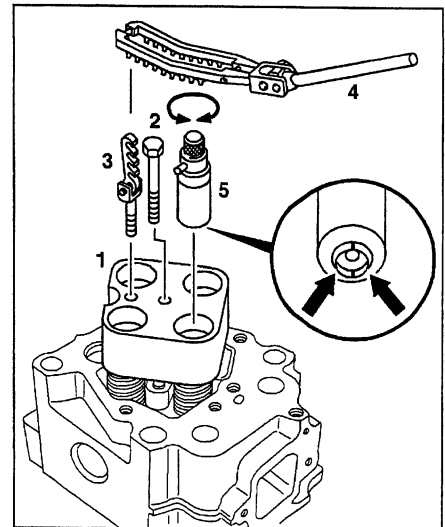

W05.30-1014-02

- 9 Take out assembly cartridge (5) together with the removed collets (6).
- 10 Remove valve spring retainer (7) and valve spring (8).
-  Inspect valve spring retainers (7) and collets (6) for wear, replace if necessary.
- 11 Pull out knurled screw at the assembly cartridge (5) and remove collets (6).

Installation

- 12 Pull out knurled screw at the assembly cartridge (5) and insert collets (6) into the guide. Slowly release pressure on knurled screw.
-  Pay attention to installation position of collets (6) relative to the internal locating drift.

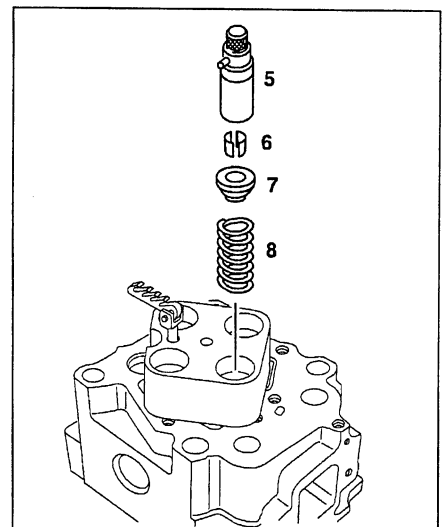

W05.30-1015-02

- 13 Insert valve spring (8) and valve spring retainer (7) into the base plate (1).
- 14 Position assembly cartridge (5) with the inserted collets (6) against the valve spring retainer (7) and compress valve spring (8) with the thrust fork (4) while at the same time pulling up the knurled screw of the assembly cartridge (5) until the collets (6) drop down and wedge in the slot of the valve stem.
- 15 Slowly release pressure on valve spring (8) and take assembly cartridge (5) up and out of the base plate (1).
- 16 Inspect whether the collets (6) are reliably installed; repeat steps 5 to 8 and 14 to 16, if necessary.

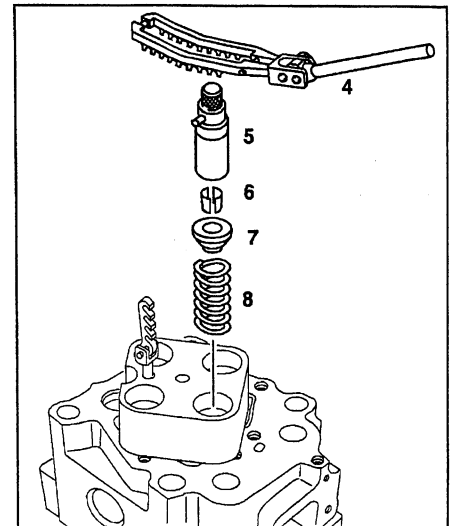

W05.30-1016-02

ENGINE 904.905 /906 /907 /909 /910 /911 /915 /916 /917 /921 /922, 906.910 /911 /915 /916 /919 /920 /921 /922 /923 /925 /926 /927 /928 /939 /942 /943

ENGINE 904.908 /923 in MODEL 668, 670

ENGINE 906.940 /941 /951 /952 in MODEL 957

- 1 Valve guide
2 Cylinder head

- A Valve guide - bore diameter in cylinder head
A1 Valve guide external dia.
B Valve guide internal dia.
C Valve guide length
D Protrusion of valve guide from seat to top edge of valve guide

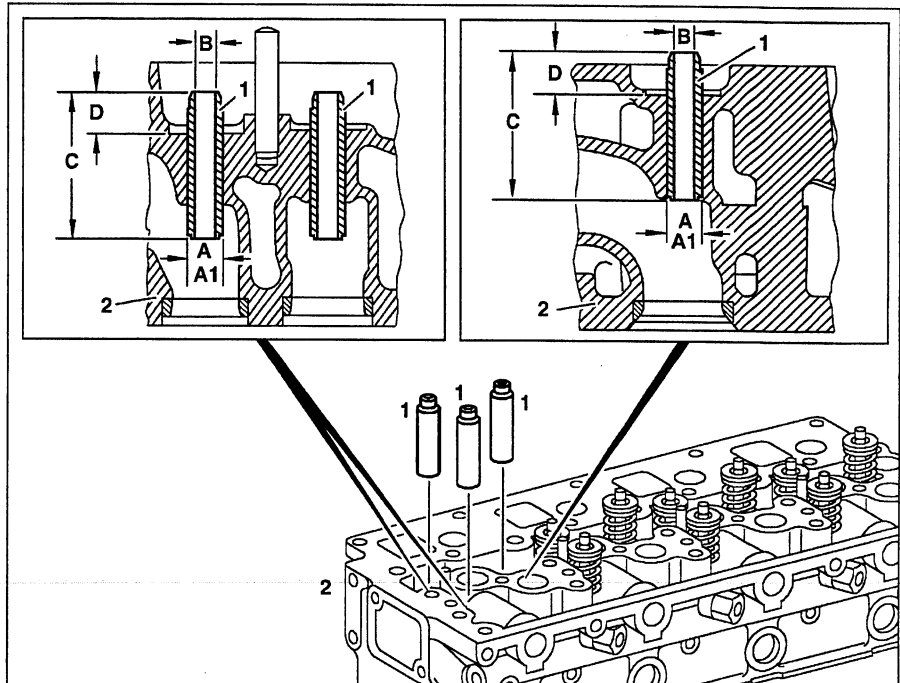

W05.30-0003-06

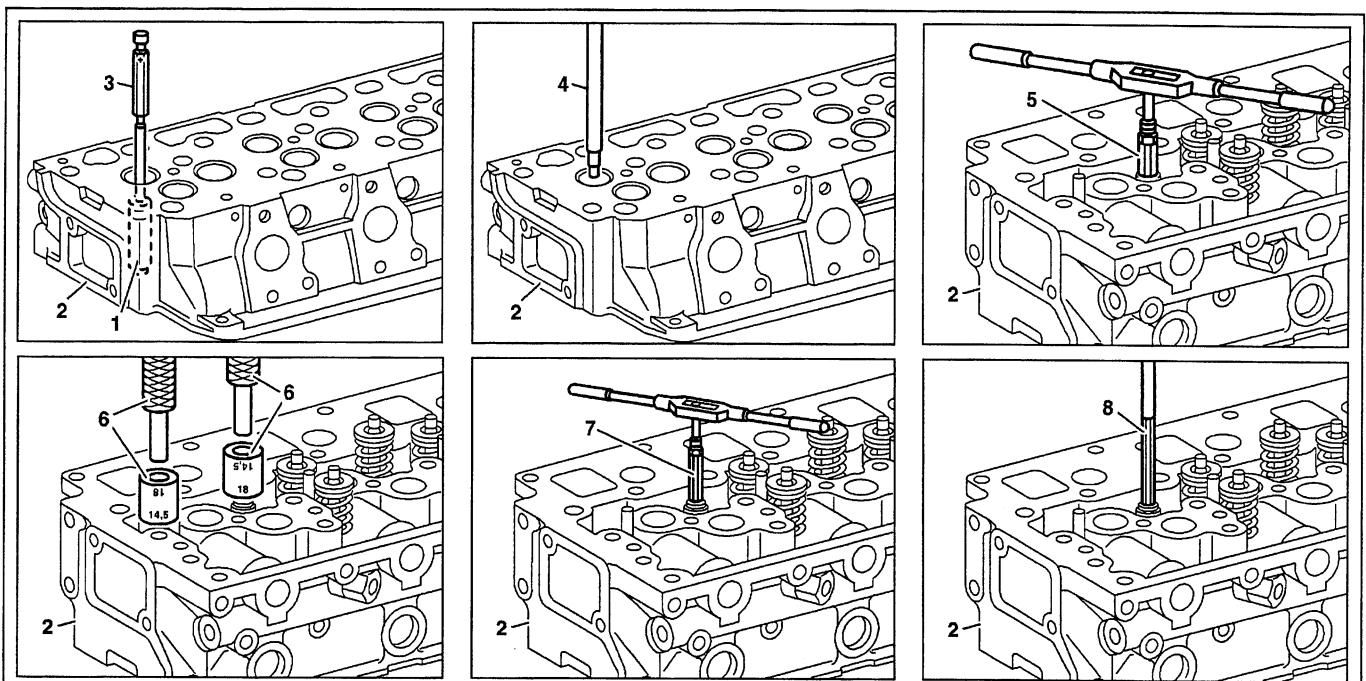





















W05.30-0059-09

- 1 Valve guide
2 Cylinder head
3 Drift
4 Stepped drift
5 Reamer (adjustable)
6 Drift with spacer sleeve
7 Reamer (adjustable)
8 Reamer



Removing

1	Remove valves		Page 71
2	Tighten cylinder head (2)		
3	Check valve guide (1) internal dia. dimension (B) with measuring probe (3)	  If the end of the measuring probe marked "+" can pass into the valve guide: ↓ Remove valve guide.	BE05.30-N-1003-02B 102 589 00 23 00
4	Remove valve guides (1) from cylinder head (2) from the combustion side		103 589 03 15 00
	Installing		
5	Measure bores of valve guides (A) in cylinder head (2)	 If values deviate from test values: ↓ Machine basic bores to next oversize of valve guide bore dia. dimension (A). Valve guide external dia. (A1)	BE05.30-N-1002-02B BE05.30-N-1001-02B
6	Ream valve guide bore dimension (A) in cylinder head (2) to next largest oversize	 Rotate reamer clockwise only. Observe overlap of valve guide (1) to cylinder head.  With engine 904.905-908/921 up to final no. 038639, use reamer (dia.12.0-13.5 mm)  With engine 904.905-908/921 up to final no. 038640, 904.909- 911/915-917/922/923, 906.910/911/915/916/919-923/925-928/ 939/940/941/942/943/951/952, use reamer (dia.13.5-15.5 mm)	BE05.30-N-1002-02B BE05.30-N-1005-02B WH58.30-Z-1015-12A 000 589 18 53 00
 Danger!	Risk of injury from handling liquid nitrogen, or from contact with supercooled objects. Risk of suffocation from inhaling nitrogen gas.	Wear heat-protective gloves, protective clothing and full eye protection. Ensure adequate ventilation.	Page 86
7	Place valve guide (1) into supercooling box and pour in liquid nitrogen	  Cool valve guide for approx. 20-30 min.	346 589 00 63 00
8	Take valve guide (1) out of supercooling box using pliers and press into heated cylinder head with drift and distance sleeve (6)	 The valve spring seating disks must be removed. Valve guide length (C)  Engine 904.905-908/921 up to final no. 038639  Engine 904.905-908/921 from final no. 038640, 904.909-911/915-917/922/923, 906.910/911/915/916/919-923/925-928/ 939/940/941/942/943/951/952, use additional sleeve.	BE05.30-N-1004-02B 904 589 01 15 00 904 589 08 63 00

		Protrusion of valve guide from cylinder head to edge of valve guide (D) Observe identification of spacer sleeve. Inlet valve = E 14.5 mm Exhaust valve = A 18.0 mm	BE05.30-N-1007-02B
9	Ream valve stem bore	 Using reamer (adjustable dia. 7.5-8.0 mm), ream to 7.95 mm dia.  Rotate reamer clockwise only. 	WH58.30-Z-1014-12A
10	Widen bore of valve guide to dimension (B) by reaming	 Rotate reamer clockwise only. 	BE05.30-N-1003-02B 000 589 21 53 00
11	Clean valve guide (1) with cleaning brush	 Valve seat turning kit	366 589 00 69 00
12	Install valves		Page 71

Test values for valve guides

Number	Designation	Engine 904.905/906/907/921		Engine 904.908	
		Standard	mm		
BE05.30-N-1001-02B	External dia. (A1)	Standard	mm	13.028-13.046	13.028-13.046
		O/u-size 0.2	mm	13.228-13.246	13.228-13.246
		See figure		-	-
BE05.30-N-1002-02B	Bore dia. in cylinder head (A)	Standard	mm	13,000-13,018	13,000-13,018
		O/u-size 0.2	mm	13,200-13,218	13,200-13,218
		See figure		-	-
BE05.30-N-1003-02B	Internal dia. (machining dimension) (B)		mm	8.000-8.022	8.000-8.022
		See figure		-	-
BE05.30-N-1004-02B	Length (C)		mm	60.0	60.0
		See figure		-	-
BE05.30-N-1005-02B	Overlap in cylinder head		mm	0.010-0.046	0,010-0,046
BE05.30-N-1007-02B	Protrusion of valve guide from seat to top edge of valve guide (D)	inlet	mm	14.1-14.5	14.1-14.5
		Exhaust	mm	17.6-18.0	17.6-18.0
		See figure		-	-

Test values for valve guides

Number	Designation	Engine 904.909/910/ 911/915/916/917/922, 906.910/911/915/916/ 919/920/921/922/923/ 925/926/927/928/939/ 940/941/951/952
BE05.30-N-1001-02B	External dia. (A1)	Standard mm 14.028-14.046
		O/u-size 0.2 mm 14.228-14.246
		See figure -
BE05.30-N-1002-02B	Bore dia. in cylinder head (A)	Standard mm 14.000-14.018
		O/u-size 0.2 mm 14.200-14.218
		See figure -
BE05.30-N-1003-02B	Internal dia. (machining dimension) (B)	mm 8.000-8.022
		See figure -
BE05.30-N-1004-02B	Length (C)	mm 60,0-60,3
		See figure -
BE05.30-N-1005-02B	Overlap in cylinder head	mm 0,010-0,046
BE05.30-N-1007-02B	Protrusion of valve guide from seat to top edge of valve guide (D)	inlet mm 13,7-14,5
		Exhaust mm 17,2-18,0
		See figure -

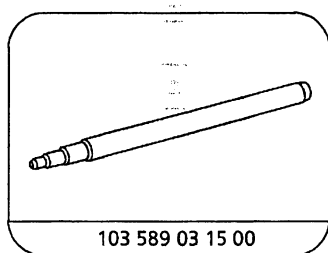

103 589 03 15 00

Stepped drift

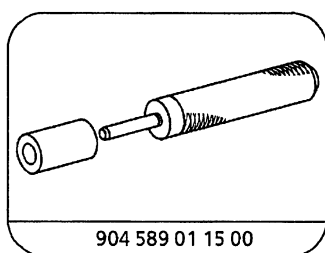

904 589 01 15 00

Insertion drift

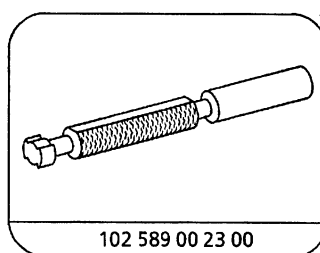

102 589 00 23 00

Drift

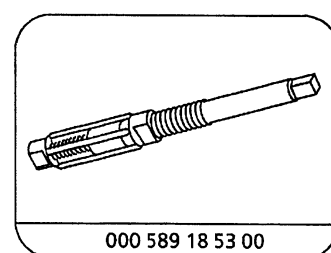

000 589 18 53 00

Reamer

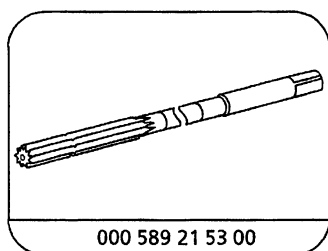

000 589 21 53 00

Reamer

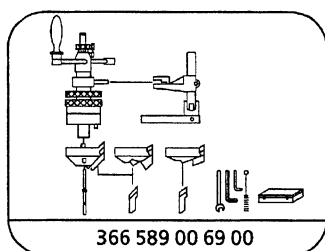

366 589 00 69 00

Valve seat turning kit

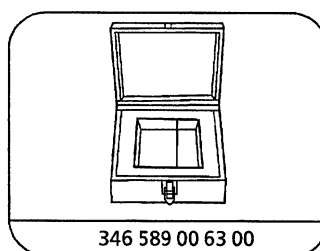

346 589 00 63 00

Supercooling box

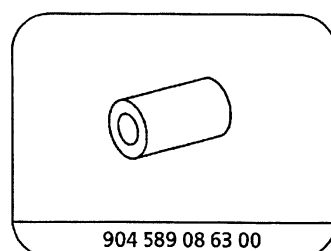

904 589 08 63 00

Sleeve

Commercially available tools (see Workshop Equipment Manual)

Number	Designation	Make (e. g.)	Order no.
WH58.30-Z-1014-12A	Reamer (adjustable dia. 7.5 - 8.0 mm)	Hunger D-81309 München 70	140 05 000

Commercially available tools (see Workshop Equipment Manual)

Number	Designation	Make (e. g.)	Order no.
WH58.30-Z-1015-12A	Reamer (adjustable dia. 12.0 - 13,5 mm)	Hunger D-81309 München 70	110 12 000

AS00.00-Z-0003-01A	Risk of injury from handling liquid nitrogen, or from contact with supercooled objects. Risk of suffocation from inhaling nitrogen gas	Wear heat-protective gloves, protective clothing and full eye protection. Ensure adequate ventilation.	 Danger!
--------------------	--	---	--

Possible hazards

Injury hazard

Contact with liquid nitrogen or supercooled objects causes frost damage to the skin similar to burns, and severe injury to the eyes.

Risk of suffocation

When liquid nitrogen evaporates this produces a nitrogen gas which can cause suffocation if it is present in high concentrations, without any noticeable warning.

Rules of conduct/protective measures



- It is not permitted to eat, drink, smoke or to store food products in the work area.
- Ensure that the work area is adequately ventilated. Never use liquid nitrogen in the area of assembly pits.
- Treat containers, equipment, valves etc with particular care; dry well before filling; secure to prevent falling over.

- Do not attempt to eliminate icing on vessels with a flame or glowing object.
- Avoid spilling liquid nitrogen when transferring it or filling it into containers. Always fill containers only up to the mark.
- Wear protective clothing, full eye protection, low temperature-resistant gloves (e.g. leather, kevlar).
- Store liquid nitrogen only in containers provided for this purpose.

First-aid measures







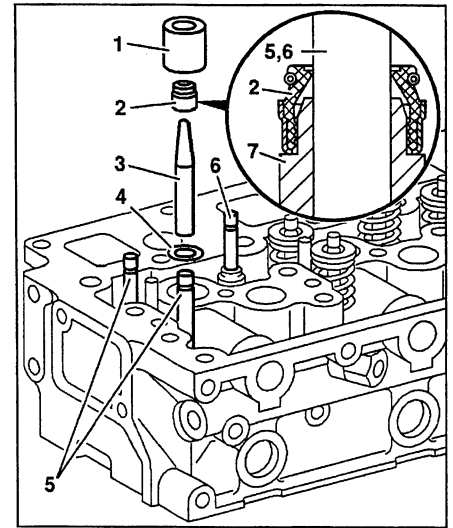

- Do not rub affected areas of the skin; pour plenty of lukewarm water over affected areas and cover over with sterile bandages.
- Immediately remove moistened clothing.
- Bring unconscious persons immediately into the fresh air and provide artificial respiration, if necessary.
- Consult a doctor without delay.

ENGINE 904.905 /906 /907 /908 /909 /910 /911 /915 /916 /917 /921 /922 /923, 906.910 /911 /915 /916 /919 /920 /921 /922 /923 /925 /926 /927 /928 /939 /940 /941 /942 /943 /951 /952

- 1  Spacer sleeve
- 2 Valve stem seal
- 3  Sleeve
- 4 Washer
- 5 Inlet valve
- 6 Exhaust valve
- 7 Valve guide



W05.30-0056-02

	Removing		
1	Remove cylinder head	Engine 904.905-907/909-911/915-917/ 921/922 Engine 906.910/911/915/916/919-923/ 925-928/939/940/941/942/943/951/952 Engine 904.908/923	AR01.30-W-5800A AR01.30-D-5800D
2	Remove valve springs	Do not remove valves.	Page 71
3	Pull off valve stem seals (2)	 Do not damage valve guides and valve stems.	
4	Take off washers (4)		
	Installing		
5	Oil valve stems of valves (5, 6) with engine oil		
6	Push sleeve (3) over the valve stem as far as a stop onto the valve guide		346 589 01 61 00
7	Fit on washer (4)		
8	Install new valve stem seal (2) with spacer sleeve (1)	 Press valve stem seal onto the valve guide as far as a stop and ensure it is tightly located at the valve guide collar.  Engine 904.905-908/921 up to end no. 038639  Engine 904.905-908/921 as of end no. 038640, 904.909-911/915-917/922/923, Engine 906.910/911/915/916/919-923/ 925-928/939/940/941/942/943/951/952	904 589 01 15 00 904 589 08 63 00
9	Take off sleeve (3)		346 589 01 61 00
10	Install valve springs		Page 71

11	Install cylinder head	Engine 904.905-907/909-911/915-917/921/922, Engine 906.910/911/915/916/919-923/ 925-928/939/940/941/942/943/951/952 Engine 904.908/923	AR01.30-W-5800A AR01.30-D-5800D
----	-----------------------	---	--

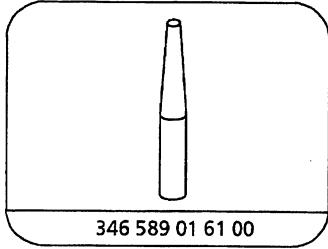

Sleeve

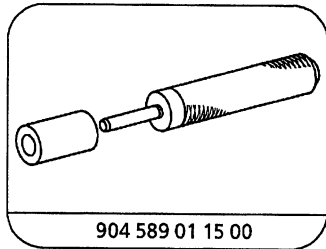

Insertion drift

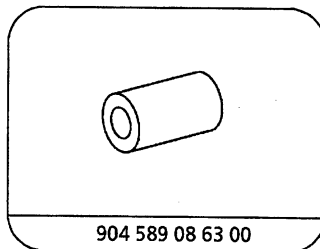

Sleeve

ENGINE 904.905 /906 /907 /909 /910 /911 /915 /916 /917 /921 /922, 906.910 /911 /915 /916 /919 /920 /921 /922 /923 /925 /926 /927 /928 /939 /942 /943

ENGINE 904.908 /923 in MODEL 668, 670







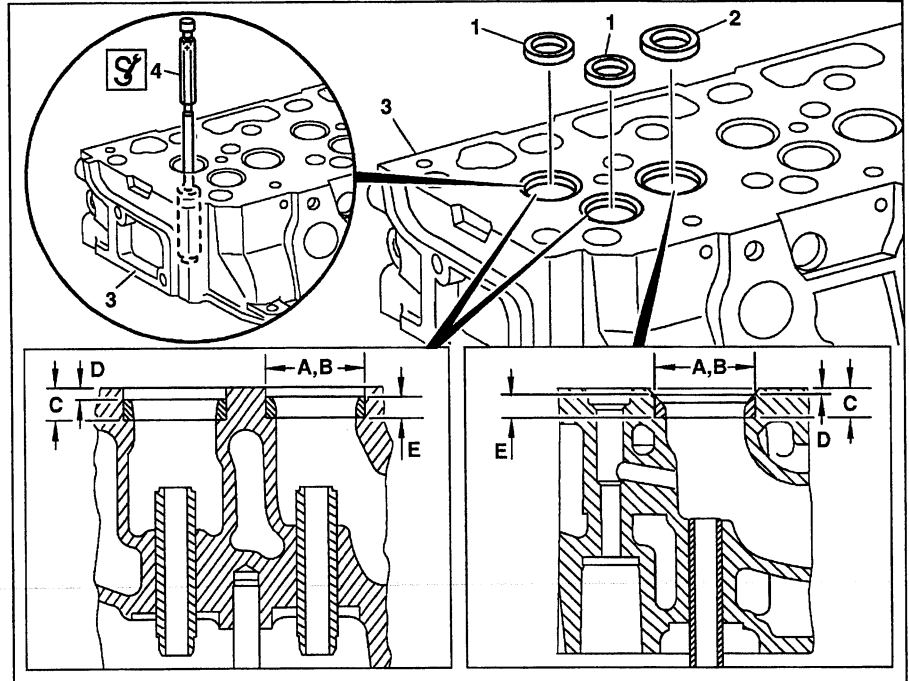



ENGINE 906.940 /941 /951 /952 in MODEL 957















- 1 Inlet valve seat ring
 2 Exhaust valve seat ring
 3 Cylinder head
 4  Plug gauge



- A Valve seat ring outer \varnothing
 B Bore dia. of valve seat rings in cylinder head
 C Bore depth of valve seat rings in cylinder head
 D Distance between contact surface of cylinder head and end face of valve seat ring
 E Valve seat ring height



W05.30-0005-06

	Removing, installing		
1	Remove valves		Page 71
2	Clamp cylinder head (3) on the cylinder head holding fixture		WH58.30-Z-1001-14A
3	Inspect valve guide inner diameter for wear with plug gage (4)		102 589 00 23 00 BE05.30-N-1003-02B BE05.30-N-1006-02B
		Valve guide internal dia. Play of valve stem in valve guide  If the end of the measuring probe marked "+" can pass into the valve guide: ↓ replace valve guide.	Page 82
4	Remove valve seat rings (1, 2) from the cylinder head (3)		Page 93
		 Valve seat turning kit  Puller  Internal extractor  Counter support  Cutting tool C7	366 589 00 69 00 000 589 28 33 00 000 589 29 33 00 000 589 34 33 00 WH58.30-Z-1005-05A

5	Measure valve seat ring bore diameter dimension (B) in cylinder head	<p> Overlap between valve seat ring dimension (A) and basic bore dimension (B) must be assured. If the measurements obtained differ from the inspection dimensions from: ↓ machine basic bores to the next oversize of the valve seat rings \varnothing (A).</p> <p>Bore dia. (B) of inlet valve seat rings Bore dia. (B) of exhaust valve seat rings Inlet valve seat rings outer \varnothing (A) Exhaust valve seat rings outer \varnothing (A) Overlap of valve seat rings in cylinder head</p> <p>  </p>	<p>BE05.30-N-1009-03B BE05.30-N-1010-03B BE05.30-N-1001-03B BE05.30-N-1002-03B BE05.30-N-1004-03B 001 589 53 21 00 WH58.30-Z-1003-12A WH58.30-Z-1004-12A</p>
6	Machine valve seat ring basic bores in the cylinder head	<p>Bore dia. (B) of inlet valve seat rings Bore dia. (B) of exhaust valve seat rings Bore depth of valve seat rings (C) Inlet valve seat rings outer \varnothing (A) Exhaust valve seat rings outer \varnothing (A) Valve seat ring height (E) Overlap of valve seat rings in cylinder head Distance between contact surface of cylinder head and end face of valve seat ring (D)</p> <p> Dial gauge  Valve seat ring turning tool  Quick calipers for internal measurements  Quick calipers for internal measurements  Micrometer  Micrometer</p>	<p style="text-align: right;">Page 96</p> <p>BE05.30-N-1009-03B BE05.30-N-1010-03B BE05.30-N-1011-03B BE05.30-N-1001-03B BE05.30-N-1002-03B BE05.30-N-1003-03B BE05.30-N-1004-03B BE05.30-N-1005-03B 001 589 53 21 00 WH58.30-Z-1025-05A WH58.30-Z-1003-12A WH58.30-Z-1004-12A WH58.30-Z-1005-12A WH58.30-Z-1007-12A</p>
<p> Danger!</p> <p>7</p>	<p>Risk of injury from handling liquid nitrogen, or from contact with supercooled objects. Risk of suffocation from inhaling nitrogen gas.</p> <p>Insert valve seat rings into supercooling box and pour in liquid nitrogen.</p>	<p>Wear heat-protective gloves, protective clothing and full eye protection. Ensure adequate ventilation.</p> <p> Supercool valve seat rings for about 20 to 30 minutes.  Supercooling box</p>	<p style="text-align: right;">Page 86</p> <p>346 589 00 63 00</p>
<p> Danger!</p> <p>8</p>	<p>Risk of injury to skin and eyes from handling hot or glowing objects.</p> <p>Heat cylinder head in a water bath</p>	<p>Wear protective gloves, protective clothing and, if appropriate, eye protection.</p> <p> Temperature approx. 80 °C.</p>	<p style="text-align: right;">Page 45</p>

9	Use pliers to remove valve seat rings (1, 2) from the supercooling box and fit onto the bores of the heated cylinder head		
10	Use a suitable drift to knock in valve seat rings (1, 2)	 The valve seat rings must be inserted without any delay.	
11	Machine valve seat rings (1, 2)		AR05.30-W-4511A
12	Install valves	 Use new valves or: ↓ grind used valves before installing.	Page 71 AR05.30-W-4202A

Test values for valve guides

Number	Designation	Engine 904.905/906/907/921	Engine 904.908
BE05.30-N-1003-02B	Inner \varnothing (machining dimension) (B)	mm	8.000-8.022
	See figure	-	-
BE05.30-N-1006-02B	Play of valve stem	inlet mm	0.050-0.087
		Exhaust mm	0.060-0.097

Test values for valve guides

Number	Designation	Engine 904.909/910/911/915/916/917/922, 906.910/911/915/916/919/920/921/922/923/925/926/927/928/939/940/941/951/952
BE05.30-N-1003-02B	Inner \varnothing (machining dimension) (B)	mm
	See figure	-
BE05.30-N-1006-02B	Play of valve stem	inlet mm
		Exhaust mm

Test data of valve seat rings

Number	Designation	Engine 904.9, 906.9	
BE05.30-N-1001-03B	Inlet valve seat ring outer dia. (A)	Standard	mm 35.07-35.08
		O/u-size 0.3	mm 35.37-35.38
		O/u-size 0.5	mm 35.57-35.58
		See figure	-
BE05.30-N-1002-03B	Exhaust valve seat ring outer dia. (A)	Standard	mm 40.07-40.08
		O/u-size 0.3	mm 40.37-40.38
		O/u-size 0.5	mm 40.57-40.58
		See figure	-
BE05.30-N-1003-03B	Valve seat ring height (E)	inlet	mm 7.6-7.7
		Exhaust	mm 8.0-8.1
		See figure	-
BE05.30-N-1004-03B	Valve seat rings - overlap in cylinder head	inlet	mm 0.045-0.080
		Exhaust	mm 0.045-0.080
BE05.30-N-1005-03B	Distance between contact surface of cylinder head and end face of valve seat ring (D)	inlet	mm 3.7-4.0
		Exhaust	mm 3.3-3.6
		See figure	-
BE05.30-N-1009-03B	Bore dia. of exhaust valve seat rings in cylinder head (B)	Standard	mm 40.000-40.025
		O/u-size 0.3	mm 40.300-40.325
		O/u-size 0.5	mm 40.500-40.525
		See figure	-
BE05.30-N-1010-03B	Bore depth of valve seat rings in cylinder head (C)	inlet	mm 11.4-11.6
		Exhaust	mm 11.4-11.6
		See figure	-
BE05.30-N-1011-03B	Inlet valve seat surface on valve seat ring machining dimension (H) related to valve seat surface dia. (G)	Dimension G	mm 31.0
		Dimension H	mm 4.2-4.4

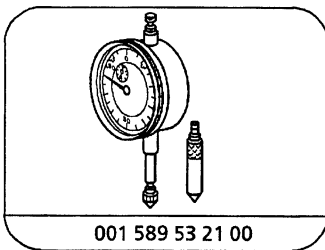

Dial gage

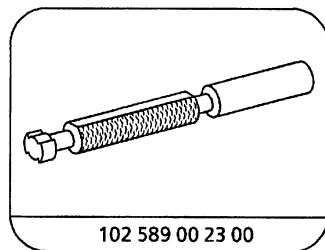

Drift

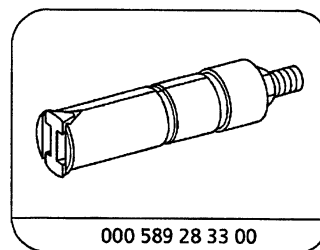

Puller dia. 28-37 mm

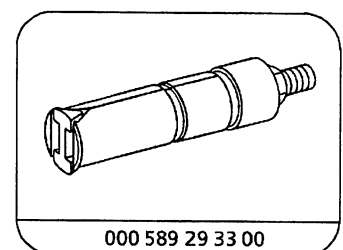

Internal extractor

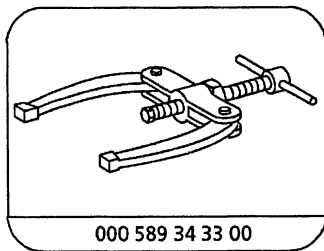

000 589 34 33 00

Countersupport

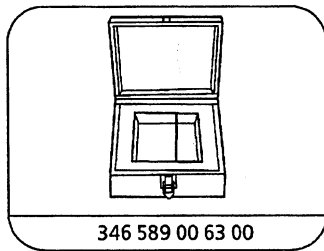

346 589 00 63 00

Supercooling box

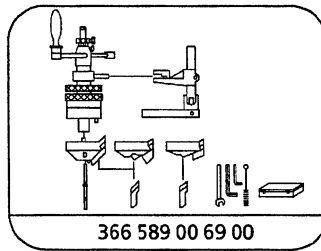

366 589 00 69 00

Valve seat turning kit

Commercially available tools (see Workshop Equipment Manual)

Number	Designation	Make (e. g.)	Order no.
WH58.30-Z-1005-05A	Cutting tool C7	Hunger D-81309 München 70	217 69 210
WH58.30-Z-1025-05A	Valve seat ring turning tool	Model RDS2 Messrs. Hunger D-81309 München 70	220.20.000
WH58.30-Z-1003-12A	Quick calipers for internal measurements, Ø 20 - 40 mm		
WH58.30-Z-1004-12A	Quick calipers for internal measurements, Ø 40 - 60 mm		
WH58.30-Z-1005-12A	Micrometer 0 - 25 mm	Hahn and Kolb Borsigstr. 50 D-70469 Stuttgart	31 400 002
WH58.30-Z-1007-12A	Micrometer 25 - 50 mm	Hahn and Kolb Borsigstr. 50 D-70469 Stuttgart	33520 080
WH58.30-Z-1001-14A	Cylinder head holding fixture	Type K2000 Hunger D-81309 München	221 00 200

AR05.30-W-3831-01A	Removing valve seat rings		
--------------------	---------------------------	--	--

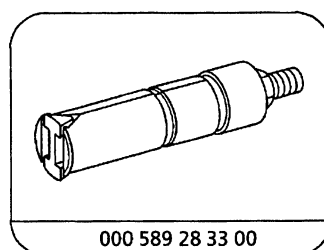

000 589 28 33 00

Puller dia. 28-37 mm

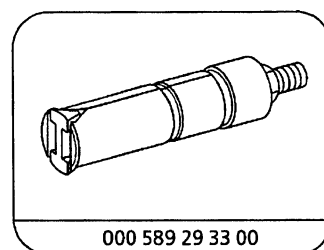

000 589 29 33 00

Internal extractor

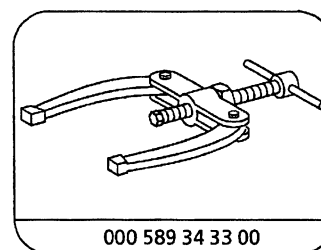

000 589 34 33 00

Countersupport

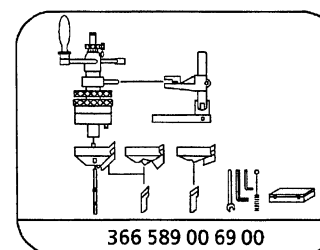

366 589 00 69 00

Valve seat turning kit

Commercially available tools (see Workshop Equipment Manual)

Number	Designation	Make (e. g.)	Order no.
WH58.30-Z-1005-05A	Cutting tool C7	Hunger D-81309 München 70	217 69 210

- 1 Insert pilot (2) (\varnothing 8 mm) into the valve guide (1) until the stop (arrow) of the tensioning clamp (3) is resting on the valve guide (1); use a screwdriver to press tensioning clamp (3) down, if necessary. Bolt tight with the drift inserted into the pilot (2) at the top and bottom.

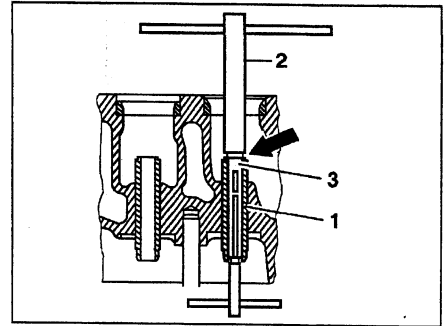

W05.30-0007-01

- 2 Attach turning head D2/20° (4) to turning tool (5), loosely screw in both hexagon socket bolts (6), align turning head (4) so that the distance between the tooth side, rack and the opposite side is about 0.5-0.8 mm beträgt. Then tighten both hexagon socket screws fully.

i It must be relatively easy to move the tool slide (8) back and forward with the quick-adjuster (9).

- 3 Tighten cutting tool C7 (7) tight at turning head (4).

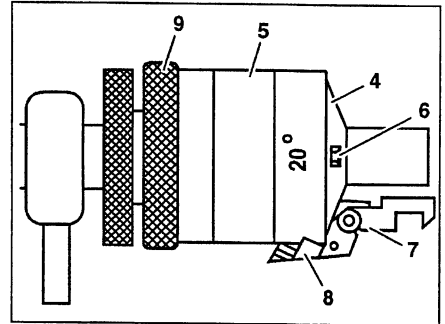

W05.30-0008-01

- 4 Moisten pilot (2) with oil.

- 5 Insert turning tool (5) over the pilot (2) until the stop pin is resting on the pilot (2) of the cutting tool (7) on the cylinder head.

! The cutting tool must not strike the cylinder head otherwise the carbide metal tip will be damaged.

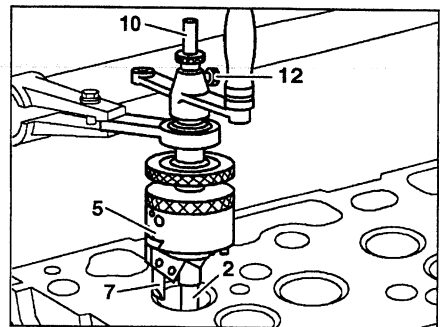

W05.30-0009-01

- 6 Turn quick-adjuster (8) until the cutting tool (7) is resting against pilot (2) or is positioned in front of the valve seat ring, but not touching.
- 7 Hold turning tool (5) tight, slacken clamping screw (12) of the stop pin (10), carefully lower turning tool until the tip of the cutting tool (7) is positioned dimension (X) approx. 1 mm above the inner edge of the valve seat ring (11). Press stop pin against pilot (2), tighten clamping screw (12) fully.
- 8 Clamp pendulum guide (13) tight horizontally, approximately in the middle of the guide, with the steady rest clamp (14).

i It must just be as easy to rotate the turning tool as before.

- 9 Hold knurled disk (15) for infeed tight and turn hand crank (16) in a clockwise direction. This generally produces an irregular chip removal.

i Inspect distance dimension (X) approx. 1 mm at valve seat ring (11).

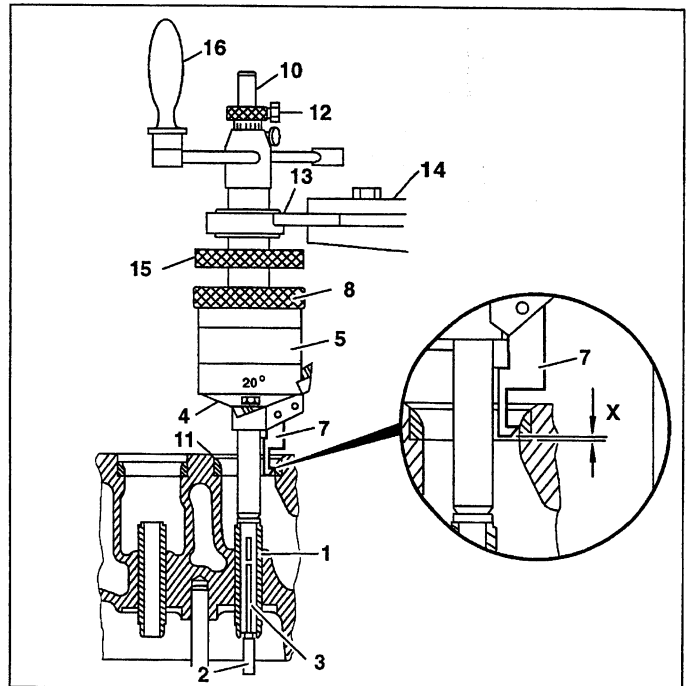

W05.30-0010-12

- 10 Turn hand crank (16) in a clockwise direction and at the same time hold the knurled disk (15) tight. As the turning resistance increases, briefly release knurled disk. Ring groove depth dimension Y approx. 2-3 mm.

i Do not take off too large a cut. It must be possible to easily rotate the turning tool, which is achieved by briefly releasing the knurled disk.

- 11 Take off turning tool.

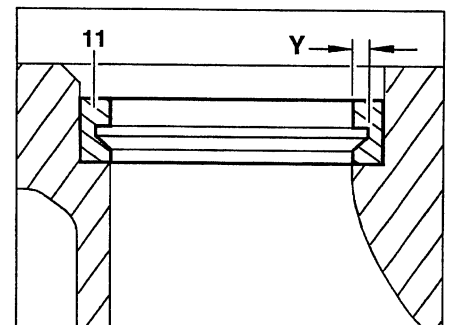

W05.30-0006-01

- 12 Position internal extractor (17) for inlet or exhaust valve seat ring (8) in the ring groove and remove valve seat ring with countersupport (18).

Place copper plates (arrows) below the contact surfaces of the countersupport to avoid damaging the cylinder head surface.

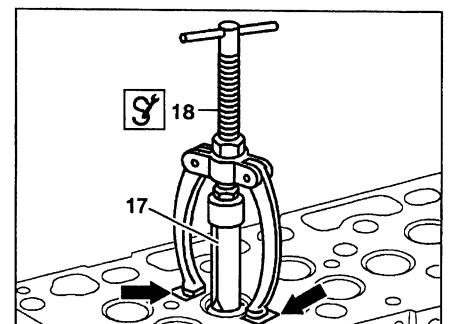

W05.30-0011-01

AR05.30-W-3831-02A	Machining valve seat ring basic bore		
--------------------	--------------------------------------	--	--

Test data of valve seat rings

Number	Designation			Engine 904.9, 906.9
BE05.30-N-1001-03B	Inlet valve seat ring outer \varnothing (A)	Standard	mm	35.07-35.08
		O/u-size 0.3	mm	35.37-35.38
		O/u-size 0.5	mm	35.57-35.58
		See figure		-
BE05.30-N-1002-03B	Exhaust valve seat ring outer \varnothing (A)	Standard	mm	40.07-40.08
		O/u-size 0.3	mm	40.37-40.38
		O/u-size 0.5	mm	40.57-40.58
		See figure		-
BE05.30-N-1003-03B	Valve seat ring height (E)	inlet	mm	7.6-7.7
		Exhaust	mm	8.0-8.1
		See figure		-
BE05.30-N-1004-03B	Valve seat rings - overlap in cylinder head	inlet	mm	0.045-0.080
		Exhaust	mm	0.045-0.080
BE05.30-N-1005-03B	Distance between contact surface of cylinder head and end face of valve seat ring (D)	inlet	mm	3.7-4.0
		Exhaust	mm	3.3-3.6
		See figure		-
BE05.30-N-1009-03B	Bore \varnothing of exhaust valve seat rings in cylinder head (B)	Standard	mm	40.000-40.025
		O/u-size 0.3	mm	40.300-40.325
		O/u-size 0.5	mm	40.500-40.525
		See figure		-
BE05.30-N-1010-03B	Bore depth of valve seat rings in cylinder head (C)	inlet	mm	11.4-11.6
		Exhaust	mm	11.4-11.6
		See figure		-
BE05.30-N-1011-03B	Inlet valve seat surface at valve seat ring machining dimension (H) related to valve seat surface \varnothing (G)	Dimens. G	mm	31.0
		Dimens. H	mm	4.2-4.4

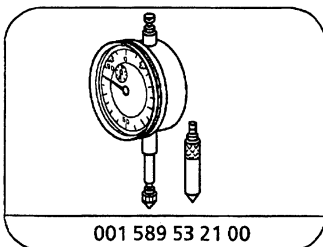

001 589 53 21 00

Dial gage

Commercially available tools (see Workshop Equipment Manual)

Number	Designation	Make (e. g.)	Order no.
WH58.30-Z-1025-05A	Valve seat ring turning tool	Model RDS2 Firma Hunger D-81309 München 70	220.20.000
WH58.30-Z-1003-12A	Quick calipers for internal measurements, \varnothing 20 - 40 mm		
WH58.30-Z-1004-12A	Quick calipers for internal measurements, \varnothing 40 - 60 mm		
WH58.30-Z-1005-12A	Micrometer 0 - 25 mm	Hahn and Kolb Borsigstr. 50 D-70469 Stuttgart	
WH58.30-Z-1007-12A	Micrometer 25 - 50 mm	Hahn and Kolb Borsigstr. 50 D-70469 Stuttgart	33520 080

- 1 Insert pilot (2) (\varnothing 8 mm) into the valve guide (1) until the stop (arrow) of the tensioning clamp (3) is resting on the valve guide; use a screwdriver to press tensioning clamp down, if necessary. Bolt tight with the drift inserted into the pilot at the top and bottom.

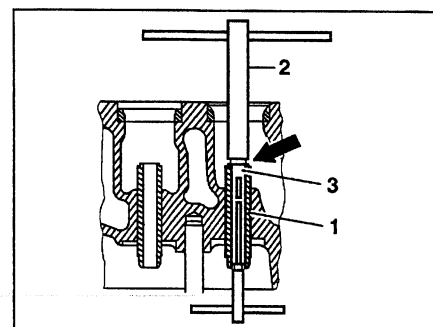

W05.30-0007-01

- 2  Bolt cutting tool (16) tight to turning tool (4).

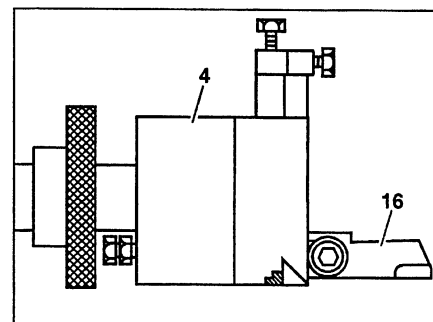

W05.30-0013-01

- 3 Moisten pilot (2) with oil, insert turning tool (4) over the pilot until the stop pin (5) is resting on the pilot or the cutting tool (16) on the cylinder head.

 Cutting tool must not strike the cylinder head otherwise the carbide metal tip will be damaged.

- 4 Turn quick-adjuster (5) until the cutting tool (16) has moved horizontally beyond the bore, then push the turning tool (4) down until the cutting tool is resting on the cylinder head.

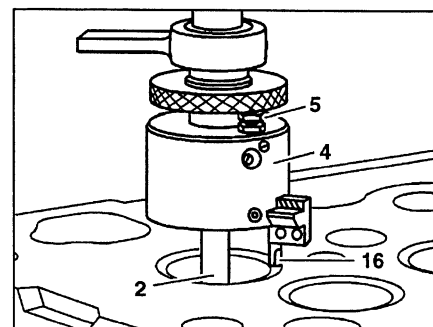

W05.30-0014-01

5 Hold turning tool (4) tight, slacken clamping screw (6) of the stop pin (7), carefully lower turning tool. Tighten clamping screw fully.

6 Set height of cutting tool (16) so that it is just clear, by turning the knurled disk (8).

7 Clamp pendulum guide (9) tight horizontally, approximately in the middle of the guide, with the steady rest clamp (10). It must still be possible to rotate the turning tool (4) just as easily as before.

i The working depth (X) must be set in this case between the adjusting ring (11) and pendulum guide.

8 Calculate the setting "G" basic bore o/u-size "B" and pilot diameter dimension "F" divided by 2.

Example:

Dimension B = 35 mm (basic bore)

Dimension F = 14.55 mm (pilot diameter)

$$\text{Dimension G} = \frac{B + F}{2}$$

$$\text{Dimension G} = \frac{35 \text{ mm} + 14.55 \text{ mm}}{2} = 24.775 \text{ mm}$$

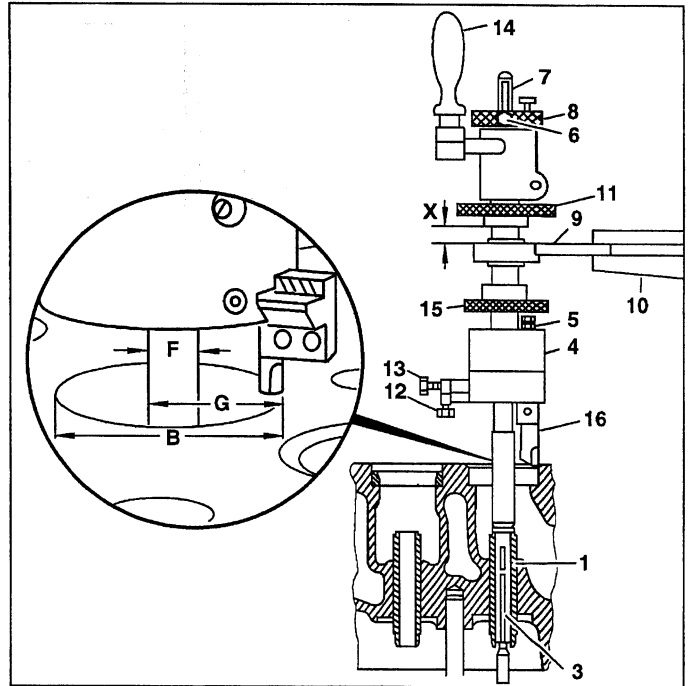

W05.30-0015-12

9 **i** Set micrometer to setting "G".

10 Slacken quick-adjuster (5), raise turning tool slightly and position **i** micrometer on the pilot. Set the cutting tool to the setting "G" with the quick adjustment. Bolt quick adjustment tight.

i It is good practice to set the cutting tool 0.1 mm less in diameter for the first cut.

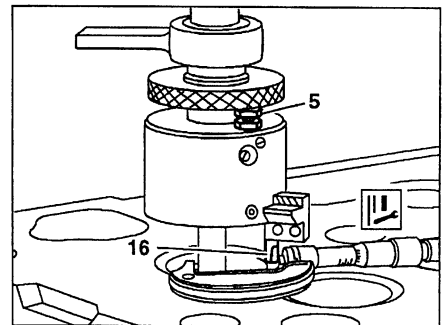

W05.30-0016-01

11 Slacken clamp screw (12). Screw in horizontal stop screw (13) until it is resting against the housing, tighten clamping screw (12) fully.

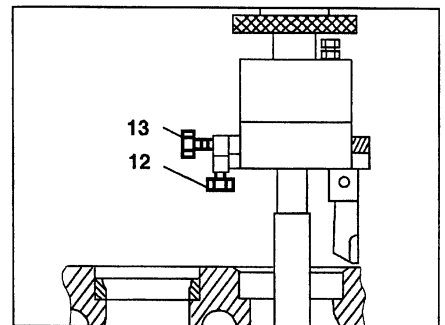

W05.30-0017-01

- 12 Fix knurled disk (8) in place with hexagon bolt.
- 13 Turn out the basic bore for the valve seat ring by turning the hand crank (14) and at the same time holding the top knurled disk (11) for the vertical infeed tight until the setting ring (arrow) is resting against the steady rest bearing (9).

i Re-set cutting tool (16) as often as necessary until the calculated setting "G" is achieved.

Then, turn once again fully without any chip feed.

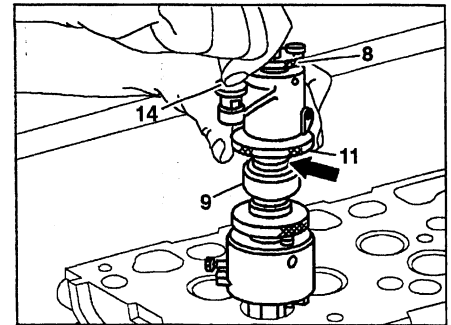

W05.30-0018-01

- 14 Raise turning tool (4) slightly. Slacken quick adjustment (5) and move back cutting tool (16).
- 15 Turn the end face at the bottom by turning the hand crank (14) and at the same time holding the bottom knurled disk (15) for horizontal infeed tight until the stop screw (13) is touching the turning tool (4).

- 16 Take off turning tool.

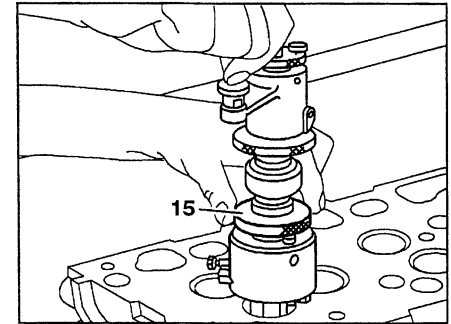

W05.30-0019-01

- 17 Use quick calipers for internal measurement and dial gauge to measure the basic bores (B) for the valve seat rings in the cylinder head..

i Overlap between valve seat ring dimension (A) and basic bore dimension (B) must be assured.

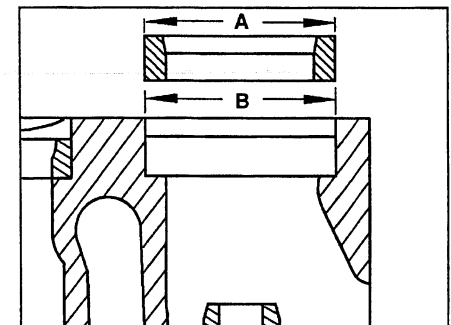





W05.30-0020-01

Part 3

ENGINE 904.905 /906 /907 /909 /910 /911 /915 /916 /917 /921 /922, 906.910 /911 /915 /916 /919 /920 /921 /922 /923 /925 /926 /927 /928 /939 /942 /943

ENGINE 904.908 /923 in MODEL 668, 670

ENGINE 906.940 /941 /951 /952 in MODEL 957

- 1 Inlet valve
- 2 Exhaust valve
- 3 Cylinder head
- 4  Turning unit
- 5  Cylinder head holding fixture
- 6 Valve seat ring
- 7  Dial gauge
- 8  Dial gauge holder

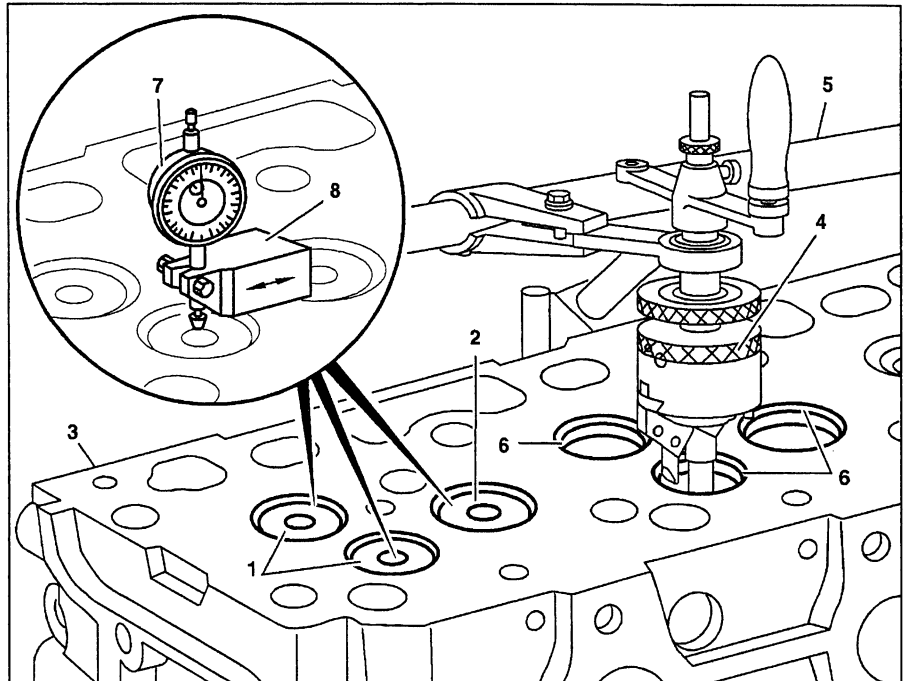

W05.30-0062-06





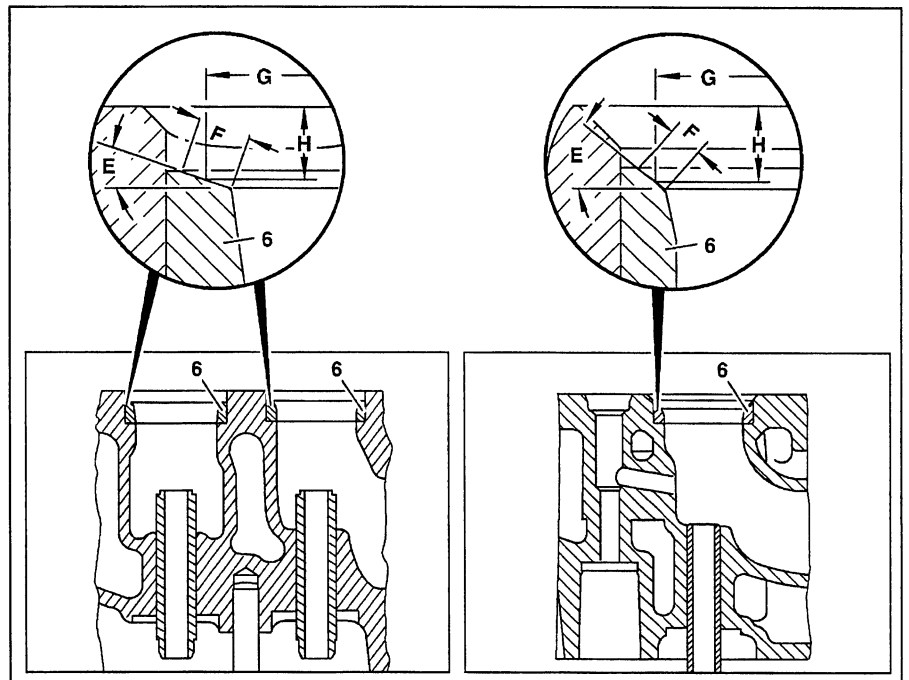





- 6 Valve seat ring

- E Valve seat angle on valve seat ring
- F Valve seat width on valve seat ring
- G Valve seat surface dia. on valve seat ring related to machining dimension (H)
- H Machining dimension (inspection dimension related to valve seat surface dia. (G))



W05.30-0065-06

	Removing		
1	Remove cylinder head	Engine 904.905- 907/909- 911/921/922 and 906.910/911/920- 923/940/941	AR01.30-W-5800A
		Engine 904.908/923	AR01.30-D-5800D

2	Remove valve spring		AR05.30-W-3511A
3	Clamp cylinder head (3) on the cylinder head holding fixture (5)		WH58.30-Z-1001-14A
	Inspecting		
4.1	Measure valve set-back to cylinder head (3)	<p>Engine 904.905- 908/921 up to 039739</p> <p> Measure valve set-back on the exhaust valve and on both inlet valves and note.</p> <p></p> <p></p> <p> If the measurement obtained is not within the permissible tolerance, the valves (1, 2) must be inspected. If wear is present, replace valve and inspect valve seat rings (6).</p>	<p>Page 8</p> <p>BE05.30-N-1001-01B</p> <p>001 589 53 21 00</p> <p>343 589 00 40 00</p>
4.2	Measure valve set-back and permissible difference to cylinder head (3)	<p>Engine 904.905- 908/921 from 039740 904.909- 911/922/923, 906.910/911/920- 923/940/941</p> <p> Measure valve set-back on the exhaust valve and on both inlet valves and note.</p> <p>Permissible difference between both inlet valve stem ends must not be exceeded.</p> <p></p> <p></p> <p></p> <p> If the measurement obtained is not within the permissible tolerance, the valves (1, 2) must be inspected. If wear is present, replace valve and inspect valve seat rings (6).</p>	<p>Page 8</p> <p>BE05.30-N-1001-01B</p> <p>BE05.30-N-1014-01B</p> <p>001 589 53 21 00</p> <p>343 589 00 40 00</p> <p>363 589 02 21 00</p>
5	Pull valves (1, 2) out of the cylinder head (3)	 Mark valves.	
6	Inspect valve seat rings (6)	<p> If the valve seats are slightly worn, both inlet or exhaust valve seat rings can be machined without replacing the valve seat rings.</p> <p>Valve set-back on all valves and the permissible difference between both inlet valve stem ends must not be exceeded.</p> <p>If wear present: ↓ replace valve seat rings.</p>	<p>BE05.30-N-1014-01B</p> <p>AR05.30-W-3831A</p>
7	Inspect valve guide inner diameter for wear with plug gage	<p></p> <p>Valve guide inner Ø</p> <p>Play of valve stem in valve guide</p> <p>Valve stem Ø</p> <p> If the end of the measuring probe marked " + " can pass into the valve guide: ↓ replace valve guide.</p>	<p>102 589 00 23 00</p> <p>BE05.30-N-1003-02B</p> <p>BE05.30-N-1006-02B</p> <p>BE05.30-N-1007-01B</p> <p>AR05.30-W-3731A</p>
	Machining		

8	Machine valve seat ring (6) in cylinder head (3)	<p>ⓑ Engine 904.905- 908/921 as of 039740, 904.909- 911/922/923, 906.910/911/ 920- 923/940/941 both intake valve seat rings must be machined the same. The permissible difference between both valve stem ends must not be exceeded.</p> <p>☑</p> <p>Valve seat angle on valve seat ring (E)</p> <p>Valve seat width on valve seat ring (F)</p> <p>Inlet valve seat surface on valve seat ring machining dimension (H) related to valve seat surface dia. (G)</p> <p>Exhaust valve seat surface on valve seat ring machining dimension (H) related to valve seat surface dia. (G)</p> <p>ⓘ If the measurements obtained are less than the specified inspection data during machining: ↓ replace valve seat ring</p>	<p style="text-align: right;">Page 10</p> <p>BE05.30-N-1014-01B</p> <p>366 589 00 69 00</p> <p>BE05.30-N-1006-03B</p> <p>BE05.30-N-1007-03B</p> <p>BE05.30-N-1011-03B</p> <p>BE05.30-N-1012-03B</p> <p>AR05.30-W-3831A</p>
Inspecting			
9	Inspect concentricity of valve seat to valve guide	<p>Off-center of valve seat to valve guide</p> <p>Concentricity of valve seat to valve guide</p> <p>☑ Valve seat turning kit</p> <p>Ⓜ Inspection kit for valve seats</p> <p>ⓘ If there are deviations from the test values: ↓ once again machine valve seat ring (6)</p>	<p style="text-align: right;">Page 14</p> <p>BE05.30-N-1008-02B</p> <p>BE05.30-N-1009-02B</p> <p>366 589 00 69 00</p> <p>WH58.30-Z-1019-05A</p> <p style="text-align: right;">Page 10</p>
Installing			
10	Install valves (1, 2)	<p>ⓘ Use new valves or: ↓ grind used valves before installing.</p>	<p>AR05.30-W-3511A</p> <p style="text-align: right;">Page 16</p>
11	Install cylinder head	<p>Engine 904.905- 907/909- 911/921/922 and 906.910/911/920- 923/940/941</p> <p>Engine 904.908/923</p>	<p>AR01.30-W-5800A</p> <p>AR01.30-D-5800D</p>

Inspection data of valves

Number	Designation	Engine 904.9 up to final no. 026066	Engine 904.9 from final no. 026067, Motor 906.9
BE05.30-N-1001-01B	Valve set-back to cylinder head contact surface	mm 1.1-1.5	1.1-1.5
BE05.30-N-1007-01B	Valve stem \varnothing (E)	inlet mm 7.935-7.950	7.935-7.950
		Exhaust mm 7.925-7.940	7.925-7.940
BE05.30-N-1014-01B	Permissible difference of inlet valves measured between cylinder head and valve stem end	mm 0.2	0.2

Test values for valve guides

Number	Designation	Engine 904.905/906/907/921	Engine 904.908
BE05.30-N-1003-02B	Inner \varnothing (machining dimension) (B)	mm 8.000-8.022	8.000-8.022
		See figure	-
BE05.30-N-1006-02B	Play of valve stem	inlet mm 0.050-0.087	0.050-0.087
		Exhaust mm 0.060-0.097	0.060-0.097
BE05.30-N-1008-02B	Valve seat to valve guide off-center	mm 0.02	0.02
BE05.30-N-1009-02B	Valve seat to valve guide concentricity	mm 0.04	0.04

Test values for valve guides

Number	Designation	Engine 904.909/910/911/915/916/917/922, 906.910/911/915/916/919/920/921/922/923/925/926/927/928/939/940/941/951/952
BE05.30-N-1003-02B	Inner \varnothing (machining dimension) (B)	mm 8.000-8.022
		See figure
BE05.30-N-1006-02B	Play of valve stem	inlet mm 0.050-0.087
		Exhaust mm 0.060-0.097
BE05.30-N-1008-02B	Valve seat to valve guide off-center	mm 0.02
BE05.30-N-1009-02B	Valve seat to valve guide concentricity	mm 0.04

Test data of valve seat rings

Number	Designation	Engine 904.9, 906.9
BE05.30-N-1006-03B	Valve seat angle on valve seat ring (E)	inlet \sphericalangle ° 20
		Exhaust \sphericalangle ° 45
		See figure -

Test data of valve seat rings

Number	Designation			Engine 904.9, 906.9
BE05.30-N-1007-03B	Valve seat width on valve seat ring (F)	inlet	mm	1.5-2.5
		Exhaust	mm	1.8-3.0
		See figure		-
BE05.30-N-1011-03B	Inlet valve seat surface on valve seat ring machining dimension (H) related to valve seat surface dia. (G)	Dimension G	mm	31.0
		Dimension H	mm	4.2-4.4
BE05.30-N-1012-03B	Exhaust valve seat surface on valve seat ring machining dimension (H) related to valve seat surface dia. (G)	Dimension G	mm	36.0
		Dimension H	mm	4.3-4.5

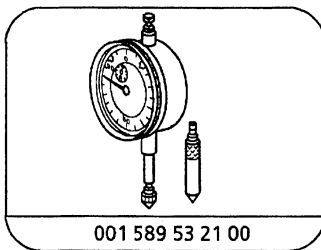

001 589 53 21 00

Dial gage

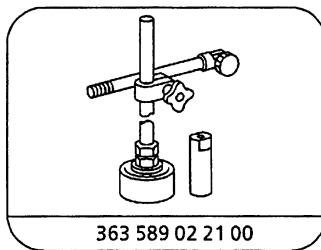

363 589 02 21 00

Dial gage holder

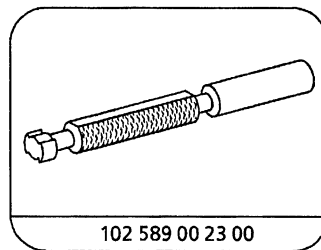

102 589 00 23 00

Drift

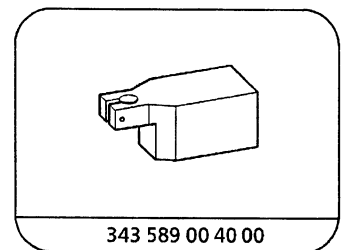

343 589 00 40 00

Dial gage holder

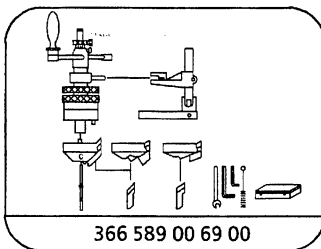

366 589 00 69 00

Valve seat turning kit

Commercially available tools (see Workshop Equipment Manual)

Number	Designation	Make (e. g.)	Order no.
WH58.30-Z-1019-05A	Inspection kit for valve seats	Hunger D-81309 München 70	217.93.610
WH58.30-Z-1001-14A	Cylinder head holding fixture	Type K2000 Hunger D-81309 München	221 00 200

AR05.30-W-4100-01A	Measuring amount by which valve stands back to cylinder head		
--------------------	--	--	--

Test data of valves

Number	Designation	Engine 904.9 up to end no. 026066	Engine 904.9 as of end no. 026067, engine 906.9
BE05.30-N-1001-01B	Amount by which valve stands back relative to cylinder head contact surface	mm 1.1-1.5	1.1-1.5

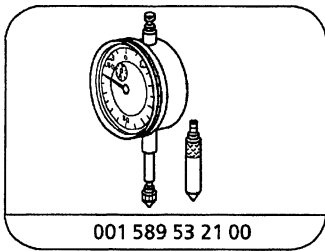



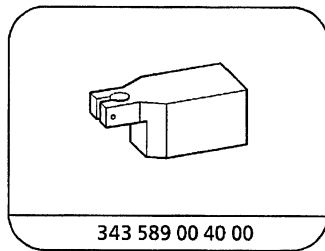

Dial gage



Dial gage holder



Valve disk (3) should be making contact with valve seat.

- 1 Attach  dial gage (1) to  dial gage holder (2).
- 2 Mount  dial gage (1) with a preload onto the plane face of the cylinder head.
- 3 Set scale of dial gage to "0".
- 4 Move  dial gage (1) sufficiently until the tracer pin is touching the valve disk (3).



If the reading obtained (A) is not within the permissible tolerance, inspect valve seat ring or the valve disk.

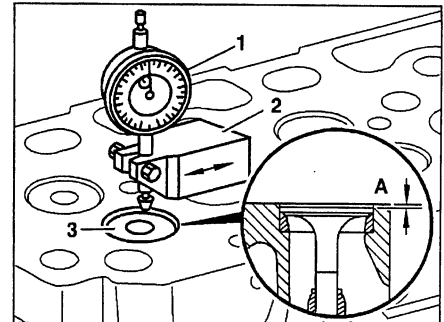

W05.30-0060-01

AR05.30-W-4100-01C	Measuring amount by which valve stands back to cylinder head		
--------------------	--	--	--

Inspection data of valves

Number	Designation	Engine 904.9 up to end no. 026066	Engine 904.9 as of end no. 026067, engine 906.9
BE05.30-N-1001-01B	Valve setback to cylinder head contact surface	mm 1.1-1.5	1.1-1.5
BE05.30-N-1014-01B	Permissible difference of inlet valves measured between cylinder head and valve stem end	mm 0.2	0.2

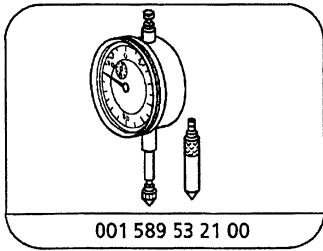

Dial gage

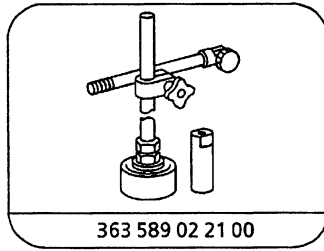

Dial gage holder

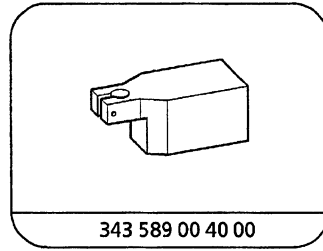

Dial gage holder

i The valve disk (3) must be resting against the valve seat.

- 1 Attach dial gage (1) to dial gage holder (2).
- 2 Mount dial gage (1) with a preload on the plane face of the cylinder head.
- 3 Set scale of dial gage to "0".
- 4 Move dial gage (1) sufficiently so that the tracer pin is positioned on the valve disk (3).

i If the inspection reading obtained (A) is not within the permissible tolerance, inspect the valve seat ring or the valve disk.

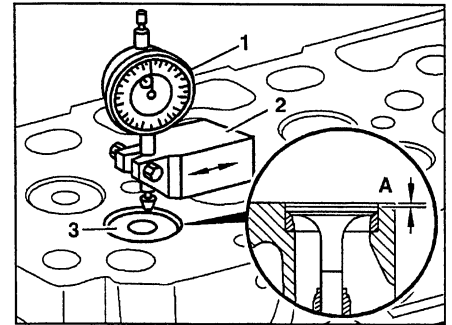

W05.30-0060-01

- 5 Attach dial gage (1) to dial gage holder (4) and mount on the top contact surface of the cylinder head.
- 6 Mount dial gage (1) with a preload onto one of the two inlet valve stem ends (5).
- 7 Set scale of dial gage to "0".
- 8 Pull back tracer pin at dial gage (1). Mount dial gage (1) onto the other inlet valve stem end (5) and take reading.

i Permissible difference (C) between both inlet valve stem ends (5) must not be exceeded.

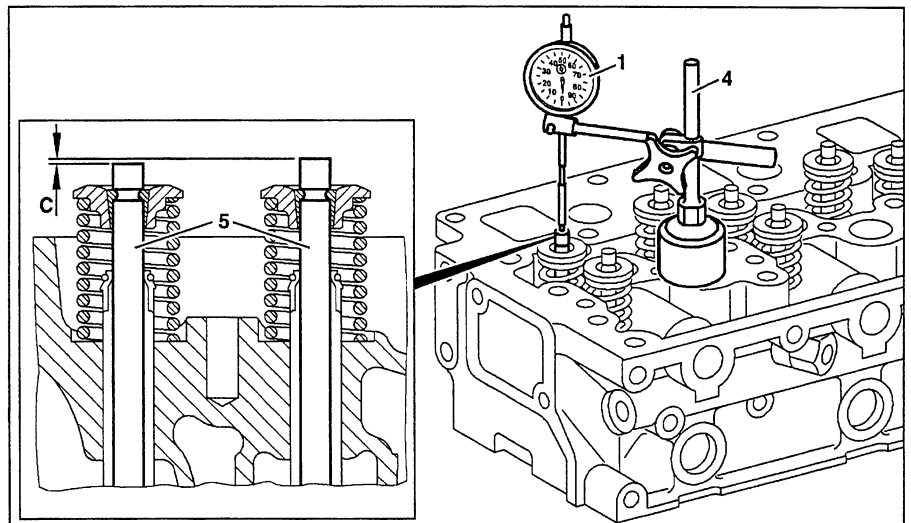

W05.30-0058-05

If the reading obtained (C) is not within the permissible tolerance, inspect the valve seat ring or the valve.

AR05.30-W-4532-01A	Machining valve seat rings with turning tool		
--------------------	--	--	--

Test data of valve seat rings

Number	Designation		Engine 904.9, 906.9
BE05.30-N-1006-03B	Valve seat angle at valve seat ring (E)	Inlet	Δ° 20
		Exhaust	Δ° 45
		See figure	-
BE05.30-N-1007-03B	Valve seat width at valve seat ring (F)	Inlet	mm 1.5-2.5
		Exhaust	mm 1.8-3.0
		See figure	-
BE05.30-N-1011-03B	Inlet valve seat surface machining dimension (H) related to valve seat surface \varnothing (G)	Dimension G	mm 31.0
		Dimension H	mm 4.2-4.4
BE05.30-N-1012-03B	Exhaust valve seat surface machining dimension (H) related to valve seat surface \varnothing (G)	Dimension G	mm 36.0
		Dimension H	mm 4.3-4.5

Inspection data of valves

Number	Designation		Engine 904.9 up to end no. 026066	Engine 904.9 as of end no. 026067, engine 906.9
BE05.30-N-1014-01B	Permissible difference of inlet valves measured between cylinder head and valve stem end	mm	0.2	0.2

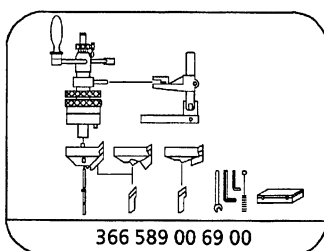

Valve seat turning kit

- 1 Insert pilot (2) (\varnothing 8 mm) into the valve guide (1) until the stop (arrow) of the tensioning clamp (3) is resting on the valve guide; use a screwdriver to press tensioning clamp down if necessary. Bolt tight with the drift inserted into the pilot at top and bottom.

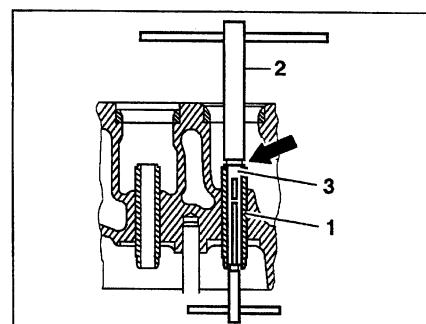

W05.30-0007-01

- 2 Fit turning head (4) onto turning tool (5), screw in both hexagon socket bolts (6) loosely, align turning head so that the distance between the rack and the opposite side is about 0.5 - 0.8 mm. Then, tighten both hexagon socket bolts fully.

Inlet valve → turning head D2/20°
 Exhaust valve → turning head D2/45°

i It must be possible to easily move the tool slide (8) back and forward with the quick-adjuster (9).

- 3 Tighten cutting tool C8 (7) at turning head (4) fully.

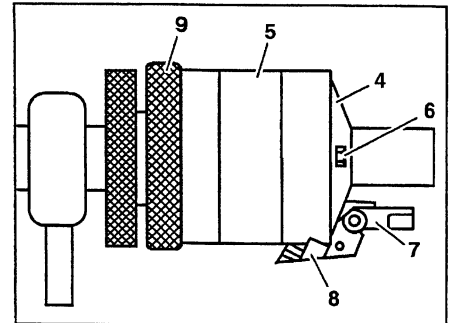

W05.30-0027-01

- 4 Moisten pilot (2) with oil.

- 5 Insert turning tool (5) over the pilot (2) until either the stop pin (10) is resting on the pilot or the cutting tool (7) on the cylinder head.

! The cutting tool must not strike the cylinder head otherwise the carbide metal tip will be damaged.

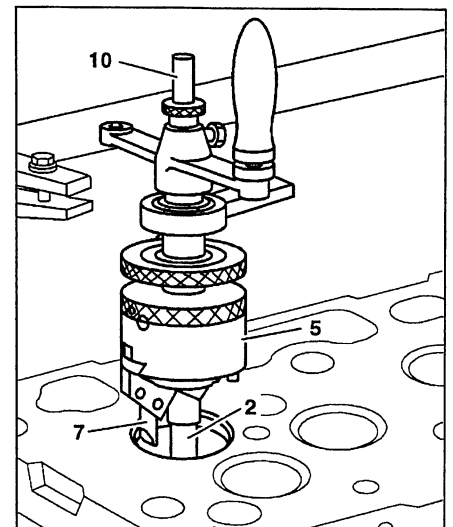

W05.30-0028-02

6 Turn quick adjuster (9) until the cutting tool (7) is positioned above the middle of the valve seat ring.

7 Hold turning tool (5) tight, slacken clamping screw (12) of the stop pin (10), carefully lower turning tool until the tip of the cutting tool (7) is positioned on the middle of the valve seat ring (11). Press stop pin against pilot (2) and tighten clamping screw (12) fully.

8 Clamp pendulum guide (13) tight horizontally, approximately in the middle of the guide, with the steadyrest clamp (14).

i It must be possible to rotate the turning tool (5) just as easily as before.

9 Make three colored markings (arrows) on the valve seat ring (11), offset about 120°, with a marker pen.

10 Raise turning tool (5) and position cutting tool (7) next to the inner valve seat edge by turning the quick-adjuster (9).

i Do not set any chip feed.

11 Hold knurled plate (15) for infeed tight and turn hand crank (16) in a clockwise direction. This generally produces an irregular chip removal.

12 After turning once fully, move the cutting tool (7) back again next to the inner valve seat edge with the quick adjuster (9).

13 Slacken lock screw (17) and turn the knurled plate (18) about 1/2 to 1 graduation (arrow) in an anti-clockwise direction. Tighten locking screw fully.

i 1 graduation = 0.1 mm infeed

14 Hold knurled disk (15) for infeed tight and turn hand crank (16) in a clockwise direction. Overturn the valve seat to the outside with the tip of the cutting tool (7).

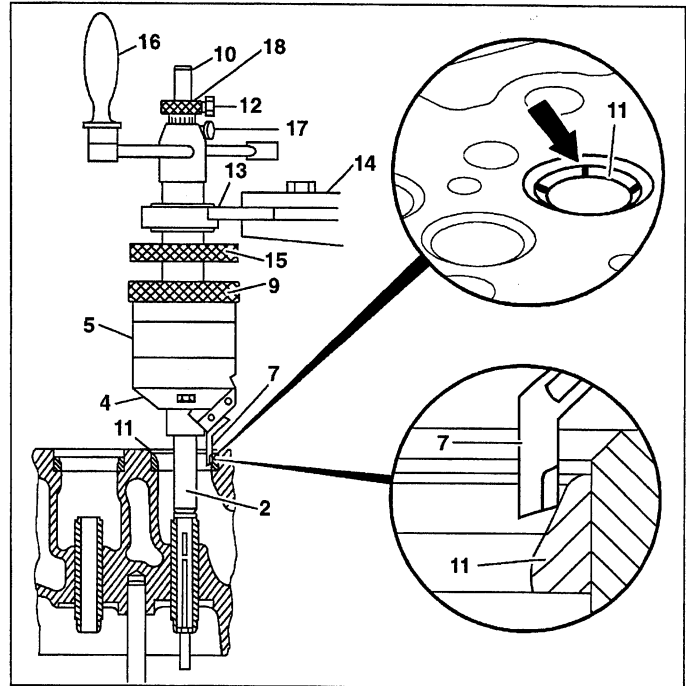

W05.30-0029-12

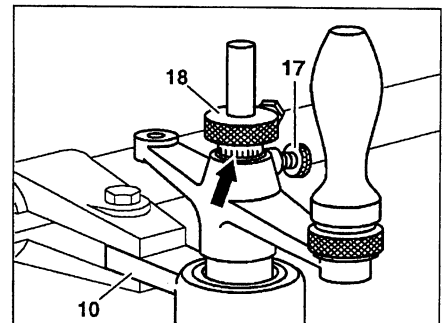

W05.30-0012-01



A chip removal should be performed as often as necessary (steps 13 and 14) until the valve seat is smooth and free of chatter marks and the valve seat width (F) and valve seat diameter (G) are achieved, see inspection data.

- E Valve seat angle at valve seat ring
- F Valve seat width at valve seat ring
- G Valve seat surface \varnothing at valve seat ring related to machining dimension (H)
- H Machining dimension (inspection dimension related to valve seat surface \varnothing (G))

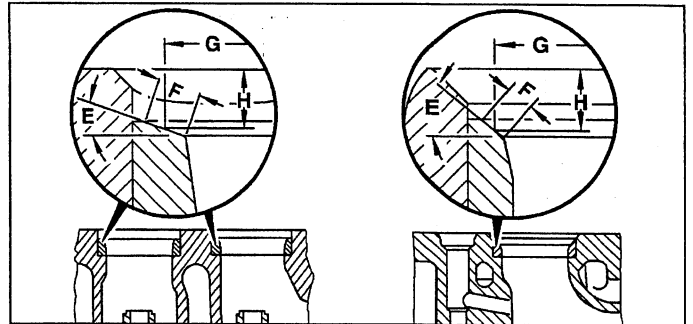

W05.30-0066-10

ⓘ Engine 904.905-908/921 as of end no. 039740, 904.909-911/922 and 906.910/911: both inlet valve seat rings must be machined with the same depth, the permissible difference between both inlet valve stem ends must not be exceeded.

- 15 Correct valve seat (11) on the outside.
 - 16 Lift turning tool (5) and slacken clamping screw (12) of the stop pin (10).
 - 17 Turn quick adjuster (9) so that the cutting tool (7) is resting on the outer valve seat edge.
- ⓘ Carefully position cutting tool on the valve seat edge.
- 18 Press stop pin (10) down until it is resting on the pilot. Screw clamping bolt (12) tight.

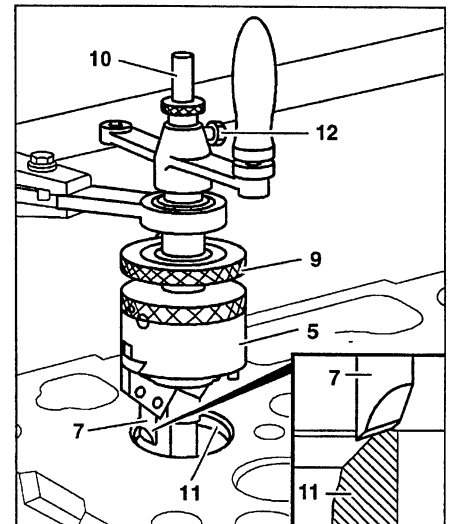

W05.30-0031-02

- 19 Slacken locking screw (17) and turn the knurled plate (18) about 1/2 graduation (arrow) in an anti-clockwise direction. Clamp locking bolt tight again.
- 20 Hold crank arms with both hands and move turning tool (5) around the pilot in stages by applying slight pressure downward.
- 21 Repeat steps 19 and 20 until the required valve seat width is achieved; refer to inspection data.

ⓘ After this, once again turn fully without any chip infeed.

- 22 Take off turning tool.

ⓘ Do not remove pilot (2).

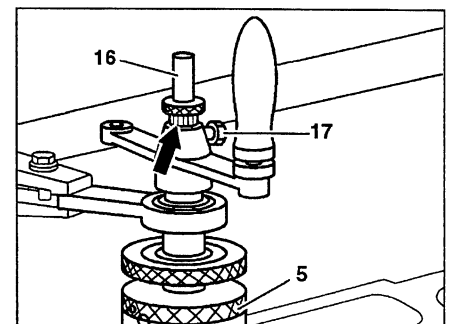

W05.30-0032-01

AR05.30-W-4532-02A	Inspecting concentricity of valve seat to valve guide		
--------------------	---	--	--

Test values for valve guides

Number	Designation	Engine 904.905/906/907/ 921	Engine 904.908
BE05.30-N-1008-02B	Valve seat to valve guide off-center	mm 0.02	0.02
BE05.30-N-1009-02B	Valve seat to valve guide concentricity	mm 0.04	0.04

Test values for valve guides

Number	Designation	Engine 904.909/910/ 911/915/916/917/922, 906.910/911/915/916/ 919/920/921/922/923/ 925/926/927/928/939/ 940/941/951/952
BE05.30-N-1008-02B	Valve seat to valve guide off-center	mm 0.02
BE05.30-N-1009-02B	Valve seat to valve guide concentricity	mm 0.04

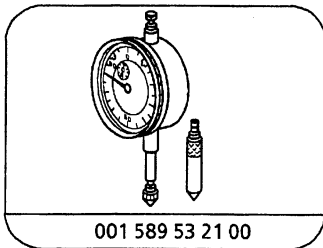



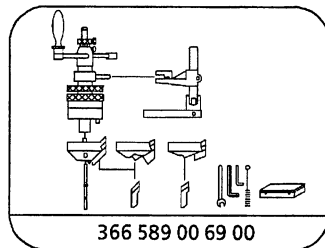

Dial gage



Valve seat turning kit

Commercially available tools (see Workshop Equipment Manual)

Number	Designation	Make (e. g.)	Order no.
WH58.30-Z-1019-05A	Inspection kit for valve seats	Hunger D-81309 München 70	217.93.610
WH58.30-Z-1001-14A	Cylinder head holding fixture	Type K2000 Hunger D-81309 München	221 00 200

- 1  Guide clamp ring (1) over installed valve turning tool pilot and tighten.
- 2  Place testing unit (2) on clamp ring (1).
- 3 Set feeler probe of test unit (2) under preload on center of valve seat.
 Turn test unit slowly around the pilot, checking concentricity deviation of valve seat to valve guide, see test values.
- 4  Remove test unit (2), clamp ring(1) and pilot.

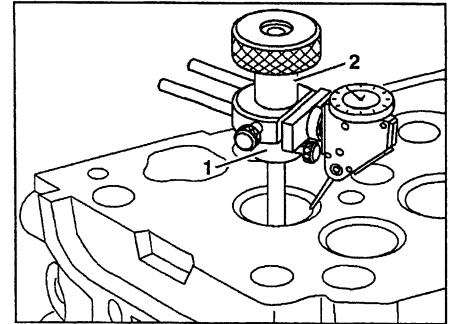

W05.30-0063-01

ENGINE 904.905 /906 /907 /909 /910 /911 /915 /916 /917 /921 /922, 906.910 /911 /915 /916 /919 /920 /921 /922 /923 /925 /926 /927 /928 /939 /942 /943

ENGINE 904.908 /923 in MODEL 668, 670

ENGINE 906.940 /941 /951 /952 in MODEL 957





- 1 Valve
2  Valve grinding machine

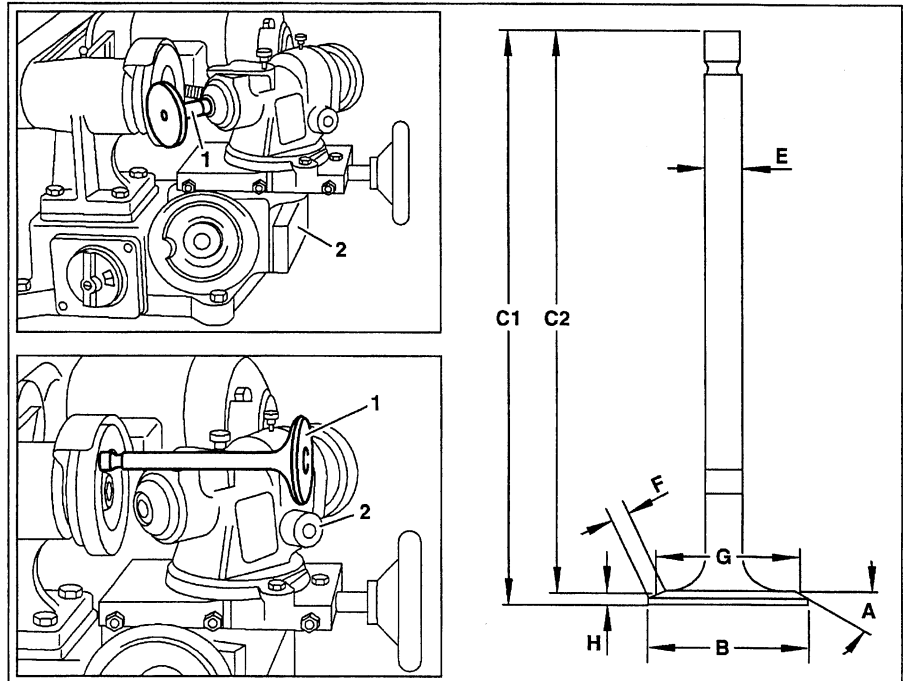

- A Valve seat angle
B Valve disk \varnothing
C1 Valve length (engine 904.905-908/921 up to end no. 039739)
C2 Valve length (engine 904.905-908/921 as of end no. 039740, 904.909-911/915-917/922/923, 906.910/911/915/916/919-923/925-928/939/940/941/942/943/951/952)

- E Valve stem \varnothing
F Valve seat width at valve disk
G Valve seat surface \varnothing
H Valve seat surface machining dimension related to valve seat surface \varnothing (G)



W05.30-0061-06

	Grinding		
1	Clean valves (1)	 Remove adhering oil carbon.	
2	Clamp valve (1) in place	 The valve should be clamped in the valve grinding machine (2) just behind the valve disk in order to avoid interfering vibrations. 	WH58.30-Z-1022-05A
3	Set valve seat grinding angle at valve grinding machine (2)		BE05.30-N-1003-01B
4	Slowly move valve (1) with the infeed toward the rotating grinding wheel until it comes into contact with the seat surface of the valve (1)		
5	Continue grinding with a small infeed until the entire circumference of the valve seat is smooth and free of chatter marks	 After this operation the measurements must not be less than the specifications. Valve disk \varnothing (B) Valve length (C) Valve stem \varnothing (E) Valve seat width at valve disk (F) Inlet valve seat surface machining dimension (H) related to valve seat surface \varnothing (G)	BE05.30-N-1004-01B BE05.30-N-1006-01B BE05.30-N-1007-01B BE05.30-N-1005-01B BE05.30-N-1008-01B

		Exhaust valve seat surface machining dimension (H) related to valve seat surface \varnothing (G)	BE05.30-N-1009-01B
		Concentricity of valve seat to valve stem  	BE05.30-N-1011-01B 001 589 53 21 00 363 589 02 21 00
6	Unclamp valve (1) at valve grinding machine		
N	Fit valve (1) onto the valve grinding machine fixture (2) and face the end of the valve stem	 After this operation the valve length (C1, C2) must not be less than the specification.	BE05.30-N-1006-01B

Inspection data of valves

Number	Designation		Engine 904.9 up to end no. 026066	Engine 904.9 as of end no. 026067, engine 906.9
BE05.30-N-1003-01B	Valve seat angle (a)	Inlet \sphericalangle°	20	20
		Exhaust \sphericalangle°	45	45
BE05.30-N-1004-01B	Valve disk \varnothing (B)	Inlet mm	33.9-34.1	33.9-34.1
		Exhaust mm	37.9-38.1	37.9-38.1
BE05.30-N-1005-01B	Valve seat width at valve disk (F)	Inlet mm	3.3-4.3	3.3-4.3
		Exhaust mm	3.5-4.2	3.5-4.2
BE05.30-N-1006-01B	Valve length (C)	Inlet mm	125.7-126.1	125.65-126.95
		Exhaust mm	152.5-152.9	152.5-152.9
BE05.30-N-1007-01B	Valve stem \varnothing (E)	Inlet mm	7.935-7.950	7.935-7.950
		Exhaust mm	7.925-7.940	7.925-7.940
BE05.30-N-1008-01B	Inlet valve seat surface machining dimension (H) related to valve seat surface \varnothing (G)	Dimension G mm	31.0	31.0
		Dimension H mm	2.7-3.1	2.7-3.1
BE05.30-N-1009-01B	Exhaust valve seat surface machining dimension (H) related to valve seat surface \varnothing (G)	Dimension G mm	36.0	36.0
		Dimension H mm	2.5-3.2	2.5-3.2
BE05.30-N-1010-01B	Hardness at valve stem end	Inlet HRC	54-60	54-60
		Exhaust HRC	54-60	54-60
BE05.30-N-1011-01B	Concentricity of valve seat to valve stem	Inlet mm	0.03	0.03
		Exhaust mm	0.03	0.03

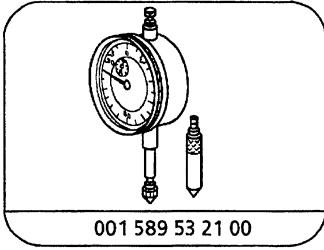

Dial gage

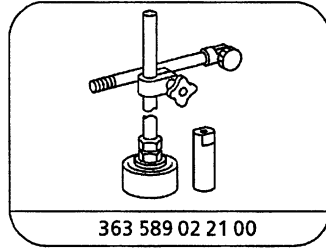

Dial gage holder

Commercially available tools (see Workshop Equipment Manual)

Number	Designation	Make (e. g.)	Order no.
WH58.30-Z-1022-05A	Valve grinding machine	Model VKM1A	231 00 001
		Hunger D-81309 München 70	231 00 002

ENGINE 904.905 /906 /907 /909 /910 /911 /915 /916 /917 /921 /922, 906.910 /911 /915 /916 /919 /920 /921 /922 /923 /925 /926 /927 /928 /939 /942 /943

ENGINE 904.908 /923 in MODEL 668, 670



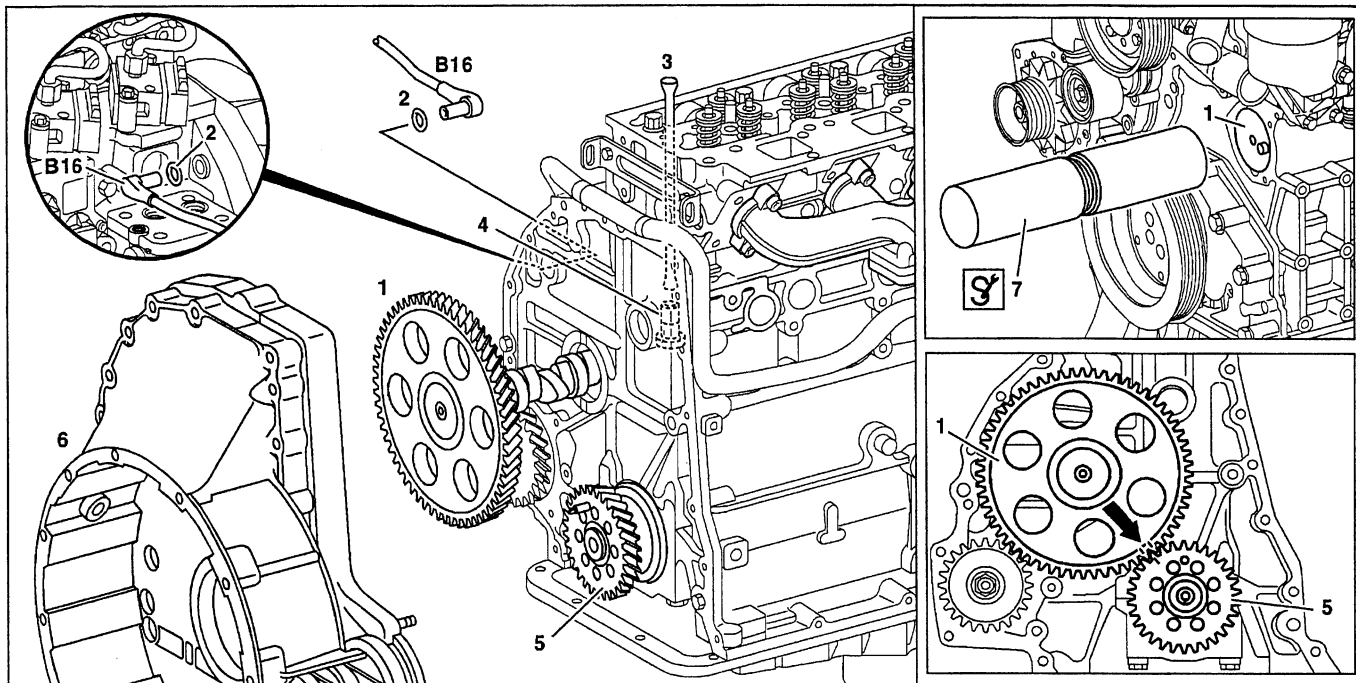

ENGINE 906.940 /941 /951 /952 in MODEL 957









W05.20-1001-09

- 1 Camshaft with camshaft sprocket
 2 O-ring
 3 Tappet rod
 4 Valve tappet
 5 Crankshaft sprocket

- 6 Timing case
 7  Guide sleeve
 B16 Camshaft TDC sensor

	Removing, installing		
1  	Extract or drain engine oil	Engine 904.905- 907/921 Engine 904.908/923 Engine 904.909-911/915-917/922, Engine 906.910/911/915/916/919-923/ 925-928/939/940/941/942/943/951/952	wh0101.40 AP18.00-D-0101A AP18.00-W-0101B
2	Remove engine	Engine 904.905-907/921 Engine 904.908/923 Engine 904.909-911/915-917/922 Engine 906.910/911/915/916 Engine 906.920-923/925-928 Engine 906.940/941/951/952	AR01.10-W-2401A AR01.10-D-2400D AR01.10-W-2400D AR01.10-W-2400F AR01.10-W-2400C
3	Insert engine into the engine repair stand	 	WE58.40-Z-1001-11A WE58.40-Z-1002-11A
4	Remove rocker arm assembly	Engine 904.905-908/921 up to end no. 039739	AR05.00-W-5521A

		Engine 904.905-908/921 as of end no. 039740, 904.909-911/915-917/922, Engine 906.910/911/915/916/919-923/ 925-928/939/940/941/951/952	AR05.00-W-5521C
5	Pull out tappet rods (3)		
6	Remove fuel pump		AR47.20-W-5713A
N	Remove all unit pumps		Page 37
8	Rotate engine in repair stand	 Rotate engine through about 180° so that the tappets (4) detach from the camshaft (1).	
9	Remove oil pan	Engine 904.905- 907/921 Engine 904.908/923 Engine 904.909-911/915-917/922, Engine 906.910/911/915/916/919-923/ 925-928/939 Engine 906.940/941/951/952	AR01.45-W-7500A AR01.45-D-7500D AR01.45-W-7500C AR01.45-W-7500D
10	Pull out camshaft TDC sensor (B16) at the crankcase	 Installation: Replace O-ring (2) and press in camshaft TDC sensor at the camshaft sprocket until it abutts.	
11	Remove timing case (6)	Engine 904.905-907/909-911/ 915-917/921/922, Engine 906.910/911/915/916/919-923/ 925-928/939/940/941/951/952 Engine 906.920-923/925-928 with timing case SAE 1 or 2, readied for engine output or installed engine output	AR01.60-W-8200A AR01.60-W-8200F
12	Pull camshaft (1) out of the crankcase		Page 21 904 589 02 14 00
13	Pull valve tappets (4) out of the crankcase	 Mark valve tappets relative to the crankcase.	
	Testing		
14	Inspect valve tappets (4)	If damage or wear present: ↓ replace roller tappet. Valve tappet outer diameter Valve tappet bore in crankcase	BE05.30-N-1004-04B BE05.30-N-1005-04B
15	Inspect hardness, concentricity and cam elevations of camshaft (1)	Hardness of cams and bearing journals Camshaft variation in concentricity Cam elevation valve cams Cam elevation unit pump   	Page 22 BE05.20-N-1005-04B BE05.20-N-1006-04B BE05.20-N-1007-04B BE05.20-N-1008-04B 000 589 20 21 00 001 589 53 21 00 363 589 02 21 00
16	Install in the reverse order		
17	Fill engine oil circuit		AR18.00-W-1600A

Inspection data of camshaft

Number	Designation		Engine 904.9	Engine 906.9	
BE05.20-N-1005-04B	Hardness of cams and bearing journals	HRC	57-63	57-63	
BE05.20-N-1006-04B	Camshaft variation in concentricity when mounted at outer bearing journals	Timing gear seat	mm	≤0.020	0.020
		Cam base circle	mm	≤0.025	0.025
		All bearing points	mm	≤0.030	0.030
BE05.20-N-1007-04B	Cam elevation valve cam over base circle Ø	Inlet	mm	≥7.3	7.3
		Exhaust	mm	≥8.2	8.2
BE05.20-N-1008-04B	Cam elevation unit pump over base circle Ø	mm	≥13.8	13.8	

Inspection data of valve timing

Number	Designation		Engine 904.9, 906.9
BE05.30-N-1004-04B	Valve tappet outer Ø	Standard	mm 17.944-17.965
		Undersize 0.25	mm 18.194-18.215
BE05.30-N-1005-04B	Valve tappet bore in crankcase	Standard	mm 18.000-18.018
		Undersize 0.25	mm 18.250-18.268

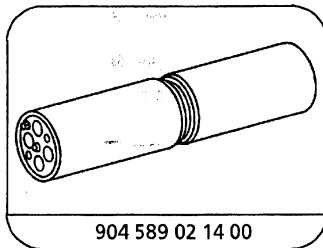

Guide sleeve

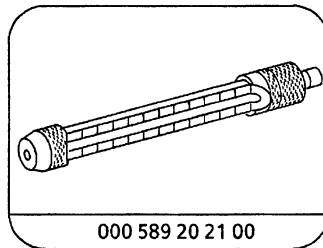

Hardness tester

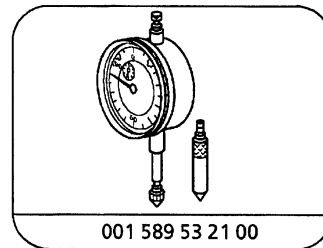

Dial gage

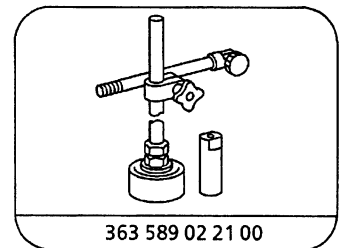

Dial gage holder

Workshop equipment/MB testers (see Workshop Equipment Manual)

WE58.40-Z-1001-11A	Engine repair stand
WE58.40-Z-1002-11A	Adapter

AR05.20-W-6292-02A	Removing, inserting camshaft		
--------------------	------------------------------	--	--

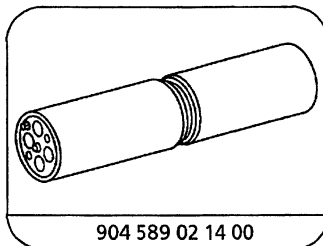

Guide sleeve

1  Attach guide sleeve (2) to front of camshaft (1) and carefully pull camshaft out of the crankcase.

 Do not damage camshaft bearings in the crankcase.

2  Attach guide sleeve (2) to the camshaft (1).

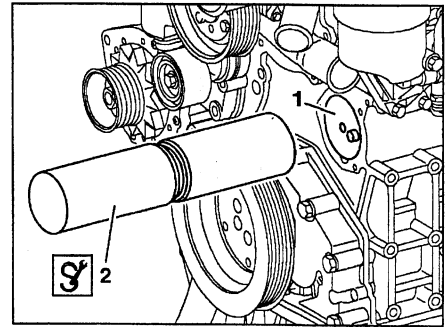

W05.20-0003-01

3 Rotate camshaft (1) until the markings "1-1" (arrow) on the camshaft sprocket are aligned with the marking "1" on the crankshaft sprocket (3).

4 Carefully push camshaft (1) into the crankcase.

 Do not damage camshaft bearings.

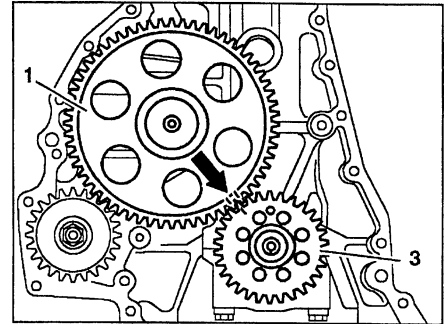

W05.20-0006-01

AR05.20-W-6292-03A	Inspecting camshaft		
--------------------	---------------------	--	--

Inspection data of camshaft

Number	Designation		Engine 904.9	Engine 906.9
BE05.20-N-1005-04B	Hardness of cams and bearing journals	HRC	57-63	57-63
BE05.20-N-1006-04B	Camshaft variation in concentricity when mounted at outer bearing journals	Timing gear seat	mm ≤ 0.020	0.020
		Cam base circle	mm ≤ 0.025	0.025
		All bearing points	mm ≤ 0.030	0.030
BE05.20-N-1007-04B	Cam elevation valve cam over base circle \varnothing	inlet	mm ≥ 7.3	7.3
		Exhaust	mm ≥ 8.2	8.2
BE05.20-N-1008-04B	Cam elevation unit pump over base circle \varnothing	mm	≥ 13.8	13.8

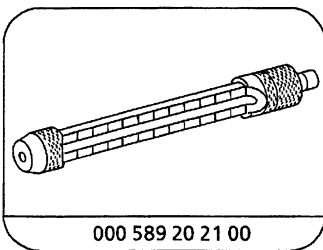

000 589 20 21 00

Hardness tester

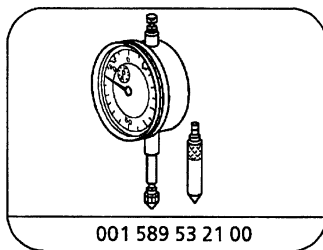

001 589 53 21 00

Dial gage

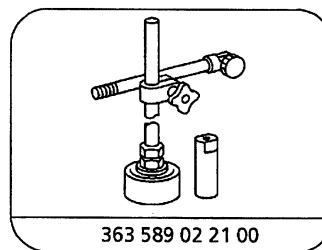

363 589 02 21 00



Dial gage holder

- 1 Inspect hardness of cams and bearing journals at the camshaft (1) with the  drop hardness tester (2).

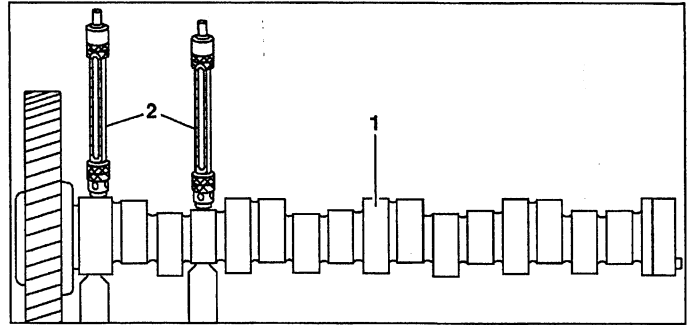
i The cam or bearing journal to be inspected must be placed down on a hard base for the test.



W05.20-0015-10

- 2 Fit camshaft (1) at the outer bearing journals.
- 3 Use  dial gage (3) to measure variation in concentricity of cam base circle or bearing points (L).
- 4 Use  dial gage (3) to measure cam elevation of valve cams of inlet valves (E) and exhaust valves (A) as well as of unit pump cams (S).

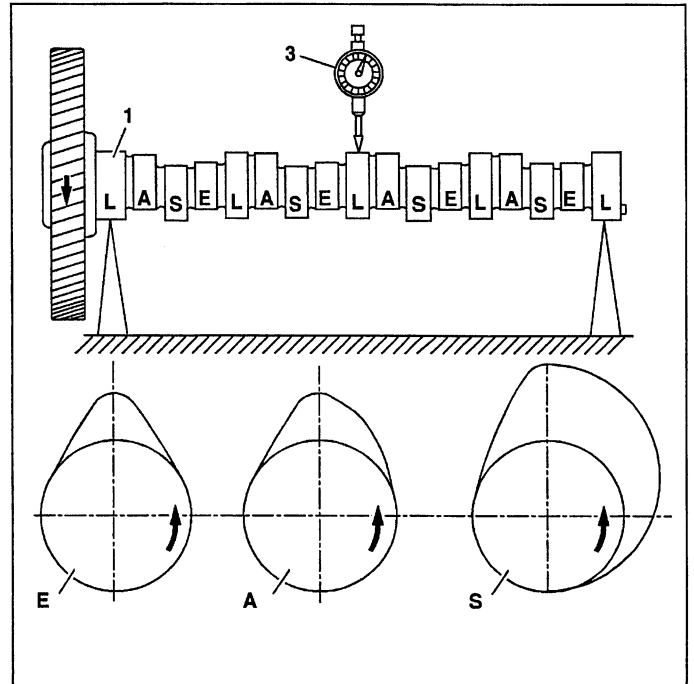

W05.20-0016-12

ENGINE 904.905 /906 /907 /909 /910 /911 /915 /916 /917 /921 /922, 906.910 /911 /915 /916 /919 /920 /921 /922 /923 /925 /926 /927 /928 /939 /942 /943

- 1 Spacer
 2 Shock absorber rubber
 3 Washer
 4.1 Nut (engine 904.905-907/921)
 4.2 Bolt (engine 904.909-911/
 915-917/922,
 906.910/911/915/916/919-923/
 925-928/939/942/943)
 5 Plug connector of vehicle wiring
 harness
 6 Plug connector of engine wiring
 harness
 7 Fuel heat exchanger
 (ENGINE 904.905-907/921)
 8 Bolt (ENGINE 904.905-907/921)
 9 Engine trim panel
 10 Electric cable of oil level sensor

A6 MR/PLD control unit

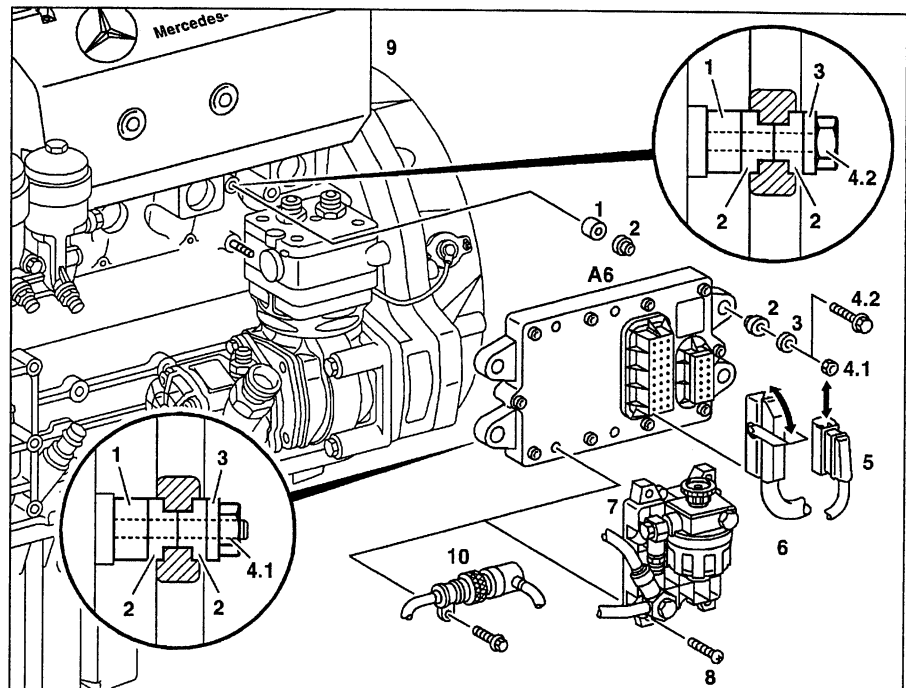

W07.15-0080-06

	Removing, installing		
	1	Switch off ignition	
⚠ Danger!	2	Risk of injury from hand being jammed and bruised when tilting cab	No person must be within the tilting range of the cab when the cab is tilted. Always tilt cab as far as the end position and secure with safety prop. Page 25
ⓘ	2	Tilt cab	
ⓘ	2	Notes on tilting cab	Model 375, 673-679, 950-954, 970-976 Page 26
	3	Remove engine trim panel (9)	
	4	Remove fuel heat exchanger (7)	Engines 904.905-908/921: the fuel lines remain attached at the fuel heat exchanger. AR47.21-W-5621A
	5	Take off electric cable of oil level sensor (10) at MR/PLD control unit (A6)	Engine 904.909-911/915-917/922, 906.910/911/915/916/919-923/925-928/939/942/943
	6	Release and separate plug connector of vehicle wiring harness (5) at MR/PLD control unit (A6)	i Release plug connector by pressing the locking arm.
N		Release and separate plug connector of engine wiring harness (6) at MR/PLD control unit (A6)	i Release plug connector by swiveling the locking arm.

8	Remove MR/PLD control unit (A6) at crankcase	<p>ⓘ The MR/PLD control unit must not be disassembled.</p> <p>ⓘ Installation: Insert spacers (1) together with shock absorber rubber (2) into the control unit and install MR/PLD control unit. Pay attention to installation position of rubber shock absorbers (2).</p>	
9	Install in the reverse order		
10	Learn all transponder keys	<p>ⓘ Only if a new MR/PLD control unit (A6) has been installed.</p>	AR80.57-W-0010A

AS60.80-Z-0001-01A	Injury hazard from pinching and crushing when cab is tilted	When tilting ensure that no one is present in the tilting area of the cab. Always tilt cab to end position and secure with safety brace.	 Danger!
--------------------	---	--	--

Injury hazard

A damaged tilting mechanism or improper handling of the tilting mechanism can lead to severe injuries when tilting the cab.

Rules of behavior/protective measures

Before tilting cab:

- Shut off engine.
- Apply parking brake.
- Secure vehicle against rolling.
- On vehicles with manual transmission, move shift lever to neutral position.
- On vehicles with automatic transmission, move selection lever to position "N":

When tilting the cab:

- Protect tilting area and particularly tilting device against unauthorized access, e.g. by blocking off or with human guard.
- Attach safety cable before tilting when so specified in the vehicle operating instructions.
- Never work under cab when partially tilted.
- Always tilt cab to end position and secure with safety brace.

AH60.80-N-0003-01A	Notes on tilting cab	Model 375, 673, 674, 675, 676, 677, 678, 679, 684, 950, 952, 953, 954, 957, 970, 971, 972, 973, 974, 975, 976	ⓘ
--------------------	----------------------	---	---

Prior to tilting cab:

- Switch off engine
- Apply parking brake
- Secure vehicle to prevent it moving off
- Remove all loose objects (e.g. cans, bottles, tools, bags etc.) from the cab
- Models fitted with manual transmission: move shift lever into Neutral
- Model 957: unlock steering column and open front flap.

Models fitted with refrigeration compartment

- The refrigeration compartment must be switched off before tilting the cab.
- The refrigeration compartment must not be switched on again until 10 minutes after tilting back the cab.
i Refer also to operating instructions of refrigeration compartment manufacturer and red information sticker on the refrigeration compartment.

The front coupling pin must be correctly inserted.



- Always tilt cab as far as the end position.
- After tilting cab, support with a prop.
- If no resistance can be felt when operating the cab tilting pump, check whether sufficient oil is present in the tilting pump.
- If a firm resistance can be felt when operating the cab tilting pump, check whether the valve lever at the tilting pump is in the desired tilting direction.

ENGINE 904.905 /906 /907 /909 /910 /911 /915 /916 /917 /921 /922, 906.910 /911 /915 /916 /919 /920 /921 /922 /923 /925 /926 /927 /928 /939 /942 /943

ENGINE 904.908 /923 in MODEL 668, 670

ENGINE 906.940 /941 /951 /952 in MODEL 957

- 1 Engine trim panel
- 2 Injection line

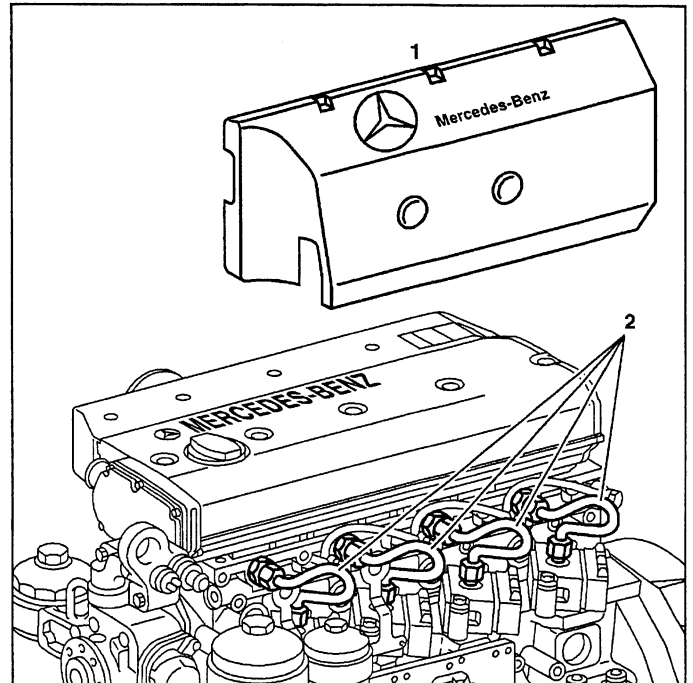

W07.15-0085-12





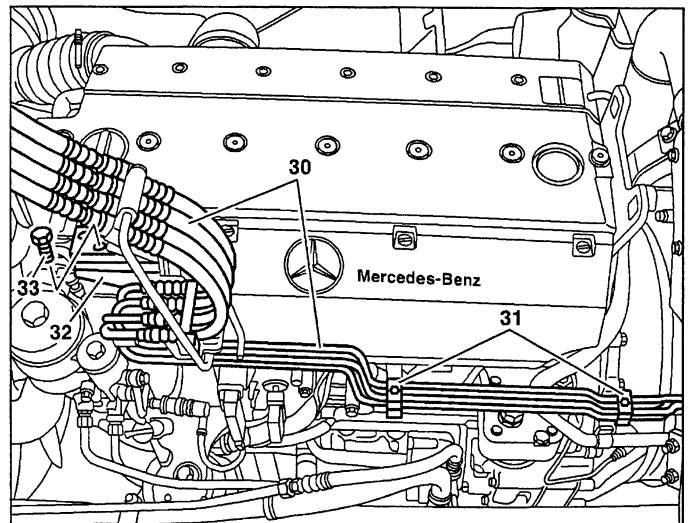







Engine 906.920-923/925-928 in combination with code (GS3) "hydraulic" transmission shift.

- 30 Hydraulic lines
- 31 Securing clamps
- 32 Securing plate
- 33 Bolt



W26.60-1011-11

	Removing		
<p>⚠ Danger!</p>	<p>Risk of injury from hand being jammed and bruised when tilting cab</p>	<p>No person must be within the tilting range of the cab when the cab is tilted. Always tilt cab as far as the end position and secure with safety prop.</p>	<p>Page 25</p>
<p>1.1</p> <p>ⓘ</p>	<p>Tilt cab</p> <p>Notes on tilting cab</p>	<p>Model 375, 673-679, 950-954, 957, 970-976</p>	<p>Page 26</p>
<p>1.2</p>	<p>Remove service cover</p>	<p>Model 668, 670</p>	

2	Detach hydraulic lines (30) together with mounting plate (32) and securing clips (31) at engine, and place to the side	Engine 906.920-923/925-928 in combination with code (GS3) "hydraulic" transmission shift.  Do not separate hydraulic lines	
3	Remove engine trim panel (1)		
 Danger!	Risk of explosion from ignition, risk of poisoning from inhaling and swallowing fuel, as well as risk of injury from skin and eye contact with fuel.	No fire, sparks, naked flames or smoking. Pour fuels only into suitable and appropriately marked containers. Wear protective clothing when handling fuel.	Page 29
4	Remove injection line (2)	 Injection line must not be detached or bent for bleeding the fuel system.  	000 589 07 03 00 000 589 68 03 00
	Installing		
5	Install injection line (2)	 Do not bend injection line; pay attention to installation position    Injection line to pressure pipe connection or unit pump	000 589 07 03 00 000 589 68 03 00 BA07.15-N-1004-01A
6	Bleed fuel system	Engine 904.905-908/921 See owner's manual	
 Danger!	Risk of accident from vehicle starting off by itself when engine running. Risk of injury from bruises and burns if you hold your hand into engine when it is started or when it is running.	Secure vehicle to prevent it moving off by itself. Wear closed and close-fitting work clothes. Do not grasp hot or rotating parts.	Page 30
N	Start engine and run	 Start engine with the starter for not more than 90 s. Wait about 2 minutes at least before repeating the start operation.	
8	Inspect injection line (2) for leaks	 If leaks are present: ↓ replace injection line.	
9	Switch off engine		
10	Install engine trim panel (1)		
11	Attach hydraulic lines at engine	Engine 906.920-923/925-928 in combination with code (GS3) "hydraulic" transmission shift.	

 **Diesel injection system with unit pumps (PLD)**

Number	Designation	Engine 904.9, 906.9
BA07.15-N-1004-01A	Injection line to pressure pipe connection of unit pump	Nm 25

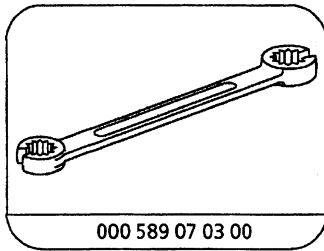

Ring wrench

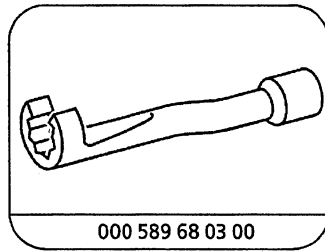

Ring wrench bit

AS47.00-Z-0001-01A	Fuel vapors present an explosion hazard. Fuel is toxic when inhaled or swallowed. Contact with fuel can cause skin and eye injury.	No fire, sparks, naked flames or smoking. Pour fuels only into suitable and appropriately marked containers. Wear protective clothing when handling fuel.	⚠ Danger!
--------------------	--	--	------------------

Possible hazards

Risk of explosion, poisoning and injury

Fuels are easily flammable and poisonous when swallowed. Fuel can cause skin damage. For example, contact with gasoline fuel removes the natural oils of the skin. Fuel vapors are explosive, invisible and disperse on the ground. They are poisonous if inhaled and have a narcotic effect if they are present in high concentrations.

Protective measures/rules of conduct

- Observe the safety precautions and regulations applicable in the specific country.
- No fire, sparks, naked flames or smoking.
- Ensure that the work place is adequately ventilated.
- Never drain or pour in fuels above assembly pits.

- Store drained fuel in suitable and sealed containers.
- Immediately eliminate fuel which has poured out.

Carrying out work on a vehicle with a naked flame (e.g. welding, etc.)

- Before commencing such work, remove the relevant parts of the fuel system and seal any open fuel lines with plugs.

First-aid measures

- Clean moistened skin with soap and water.
- Change moistened clothing as rapidly as possible
- If fuel gets into the eyes, immediately rinse out the eyes with water; contact a doctor, if necessary.

AS00.00-Z-0005-01A	Risk of accident as a result of vehicle starting off when engine is running. Risk of injury as a result of bruises and burns if you insert your hands into engine when it is being started or when it is running.	Secure vehicle to prevent it from moving off. Wear closed and close-fitting work clothes. Do not grasp hot or rotating parts.	 Danger!
--------------------	---	---	---

Possible dangers

Risk of accident

from vehicle starting off during starting operation (e.g. when testing compression pressure) as a result of gear engaged or when engine running and vehicles with automatic transmission as a result of selector lever position "P" or "N" not engaged (exception: some vehicles do not have a selector lever position "P").

Risk of injury

Severe injuries may be caused by freely rotating parts in the area of the running engine. The heat produced by the engine when it is operating can result in severe burns if contact is made with individual, unshielded parts.

Rules of conduct / Protective measures

- As a general rule, carry out work on the running engine only if this is absolutely essential.
- Before starting the engine, apply parking brake.
- On models with manual transmission, move gearshift lever into Neutral position.
- On models with automatic transmission, move selector lever into position "P" or "N" (exception: some vehicles do not have a selector lever position "P").
- On models which do not have selector lever position "P", secure selector lever to prevent it from being operated unintentionally.
- Wear closed and close-fitting work clothes.
- Take off any jewelry, such as chains, rings etc.
- If you have long hair, wear a suitable head cover.
- Before commencing work on the running engine, check to obtain a general picture of the positioning of parts which may be hot.
- When carrying out work when starting the engine or when engine is running, do not touch any hot and rotating parts.

First aid measures in the event of burns

- Do not rub the skin areas affected; flush with plenty of cold water and cover skin with sterile bandages.
- Immediately consult a physician.

ENGINE 904.905 /906 /907 /921 ## up to 40487
ENGINE 904.908 ## up to 40487 in MODEL 668, 670

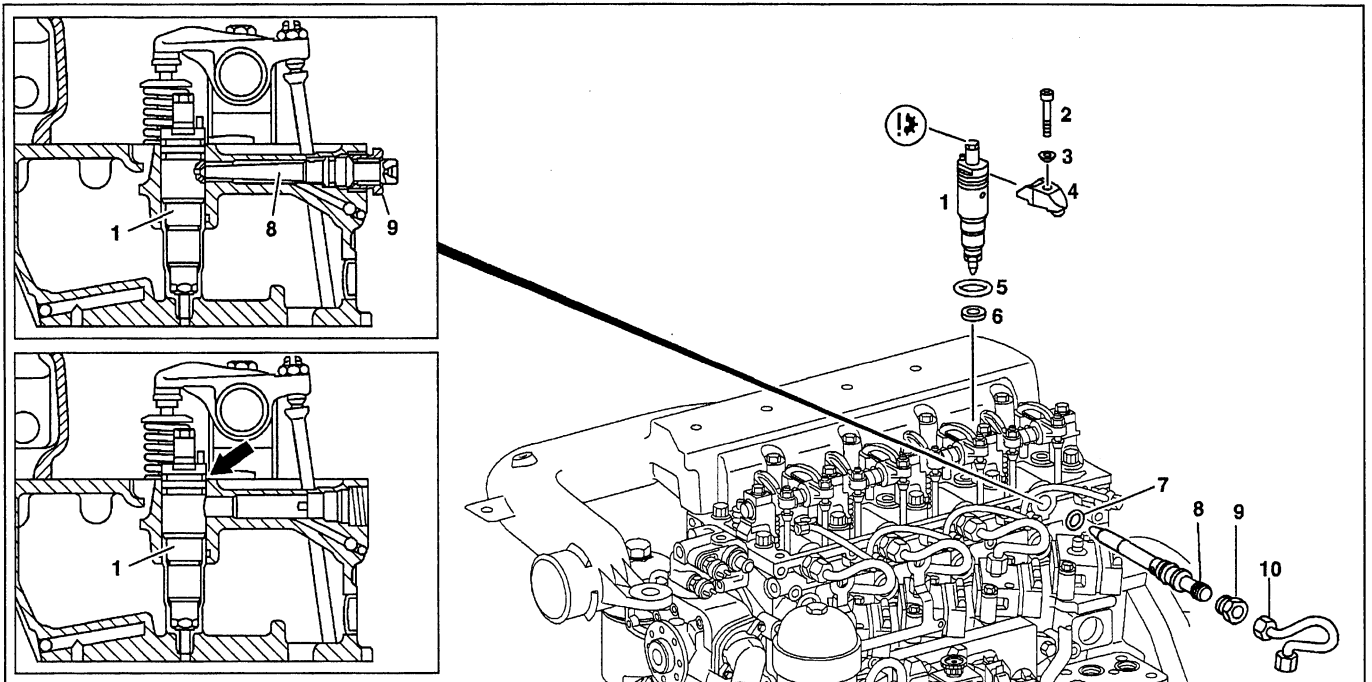

W07.03-0001-09

- 1 Nozzle holder combination
- 2 Hexagon socket screw
- 3 Spherical washer
- 4 Tensioning arm
- 5 O-ring

- 6 Seal
- 7 O-ring
- 8 Pressure pipe connection
- 9 Thrust bolt
- 10 Injection line



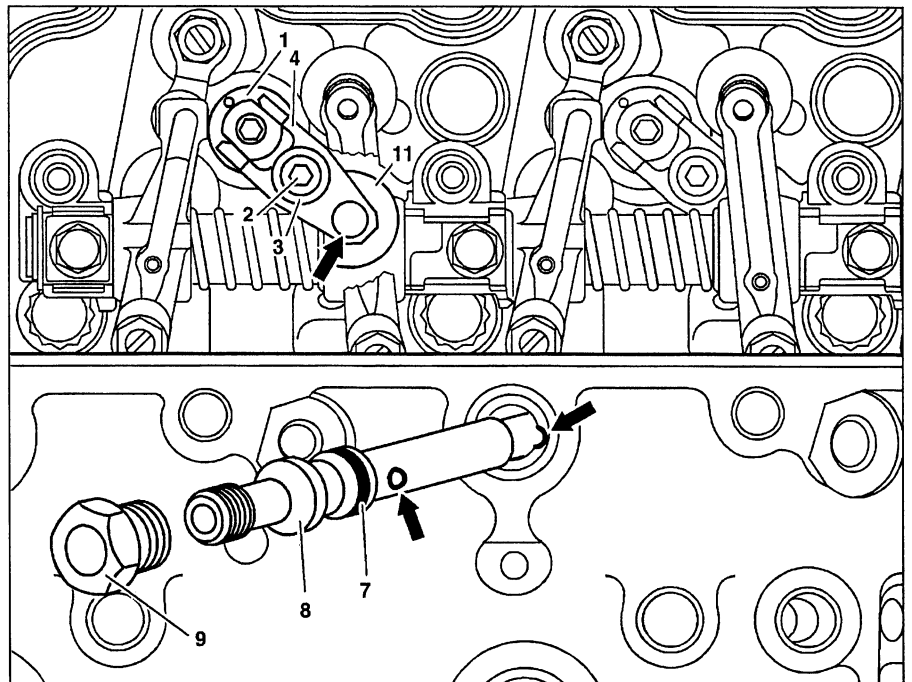







- 1 Nozzle holder combination
- 2 Hexagon socket screw
- 3 Spherical washer
- 4 Tensioning arm
- 7 O-ring
- 8 Pressure pipe connection
- 9 Thrust bolt
- 11 End cover of constant throttle



W07.03-0002-06

Revisions

7.7.98	Pay attention to installation position of seal Tightening torque for bolt of tensioning arm at cylinder head modified	Step 8 Step 10	
--------	--	-------------------	--

	Removal		
1	Remove cylinder head cover		AR01.20-W-5014A
 Danger!	Risk of explosion from ignition. Risk of poisoning from inhaling and swallowing fuel. Risk of injury as a result of fuel coming into contact with skin and eyes.	No fire, naked flame or smoking. Pour fuels only into suitable and appropriately marked containers. Wear protective clothing when handling fuel.	Page 29
2	Remove injection line (10)		Page 27
3	Remove pressure pipe connection (8)		
4	Remove tensioning arm (4)		
5	Press out nozzle holder combination (1)	 Nozzle holder combination must not be turned and pulled with a wrench or pliers otherwise the settings may be altered.  Insert screwdriver into the top groove (arrow) of the nozzle holder combination and press out. Place protective base on the cylinder head.  Nozzle holder combination must not be disassembled. If wear or problem exists ↓ replace nozzle holder combination	
6	Take off seal (6)		
	Installation		
7	Replace O-ring (5) at the nozzle holder combination (1)	 Coat O-ring with lubricant	BR00.45-Z-1018-06A
8	Fit on seal (6) at the nozzle holder combination (1)	 Replace seal. Pay attention to installation position and thickness of seal; small ring surface on seal points in direction of nozzle holder combination.	
9	Install nozzle holder combination (1)	 Pay attention to installation position of nozzle holder combination relative to pressure pipe connection. Turn nozzle holder combination in the cylinder head with the tensioning arm (4) until the interference-fit ball (arrow) in the tensioning arm is aligned with the locating element in the end cover (11) of the constant throttle.	
10	Screw spherical washer (3) and tensioning arm (4) tight	 Bolt of tensioning arm, nozzle holder combination and constant throttle to cylinder head	BA07.15-N-1003-01A
11	Replace O-ring (7) at the pressure pipe connection (8)	 Coat O-ring with lubricant.	BR00.45-Z-1018-06A

12	Install pressure pipe connection (8) and screw thrust bolt (9) tight	<p>ⓘ The interference-fit ball (arrow) at the pressure pipe connection should be inserted into the slot (arrow) in the cylinder head.</p> <p>Ⓜ Pressure pipe connection to cylinder head</p>	BA07.15-N-1005-01A
13	Install injection line (10)		Page 27
14	Install cylinder head cover		AR01.20-W-5014A

Ⓜ Diesel injection system with unit pumps (MR/PLD)

Number	Designation	Engine 904.9, 906.9
BA07.15-N-1003-01A	Bolt of tensioning arm of nozzle holder combination to cylinder head	Allen bolt Nm 30
		Bolt with twelve point head with spherical collar 35
BA07.15-N-1005-01A	Thrust bolt of pressure pipe connection to cylinder head	Nm 40

Service products for repair

Number	Designation	Order number
BR00.45-Z-1018-06A	ATE-grease	-

ENGINE 904.905 /906 /907 /921 ## as of 040488

ENGINE 904.908 ## as of 040488 in MODEL 668, 670

ENGINE 904.923 in MODEL 668, 670

ENGINE 904.909 /910 /911 /915 /916 /917 /922, 906.910 /911 /915 /916 /920 /921 /922 /923 /925 /926 /927 /928 /939 /940 /941 /942 /943 /951 /952

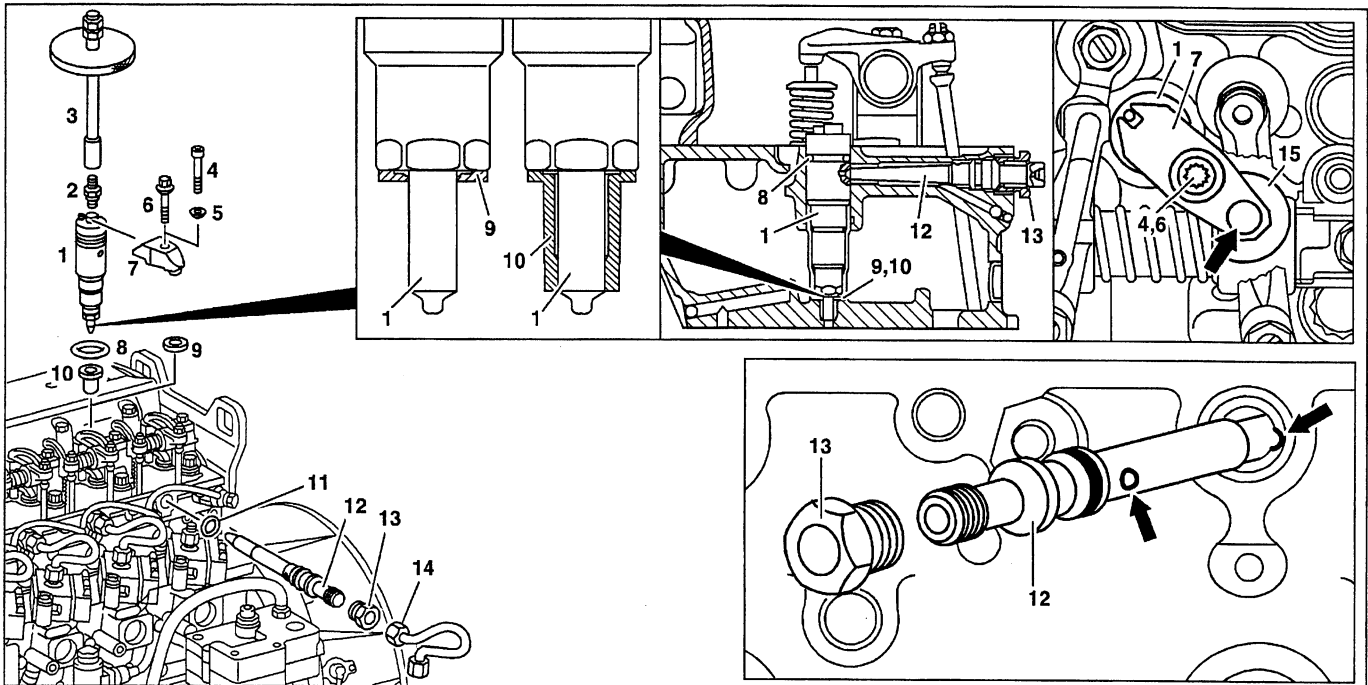

W07.03-1008-09

1 Nozzle holder combination

2 Adapter

3 Impact extractor

4 Bolt (up to engine end no. 046892)

5 Spherical washer (up to engine end no. 046892)

6 Spherical collar bolt (as of engine end no. 046893)

7 Tensioning arm

8 O-ring

9 Seal (engine 906 up to end no. 056812, engine 904)

10 Sealing sleeve (engine 906 as of end no. 056813)

11 O-ring.

12 Pressure pipe connection

13 Pressure screw

14 Injection line

15 End cover of constant throttle

Engine 906 as of end no. 056813

1 Nozzle holder combination

20.1 Mount (for nozzle holder head)

20.2 Insertion sleeve (for sealing sleeve)

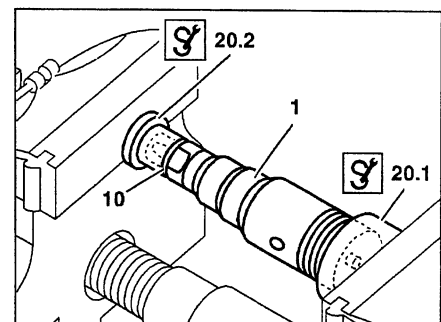















W07.03-1009-01

Modification notes

4.11.99	Sealing sleeve at nozzle holder combination, engine 906 as of end no. 056813	Steps 8, 10	
---------	--	-------------	--

	Removing		
1	Remove cylinder head cover		AR01.20-W-5014A

 Danger!	Risk of explosion from ignition, risk of poisoning from inhaling and swallowing fuel as well as risk of injury from skin and eye contact with fuel.	No fire, sparks, naked flames or smoking. Pour fuels only into suitable and appropriately marked containers. Wear protective clothing when handling fuel.	Page 29
2	Remove injection line (14)		Page 27
3	Remove pressure pipe connection (12)		
4	Remove tensioning arm (7)		
5	Attach adapter (2) and impact extractor (3) at the female thread (M8) of the nozzle holder combination (1)	 	
6	Pull out nozzle holder combination (1)	 The nozzle holder combination must not be disassembled. If wear or fault present: ↓ Replace nozzle holder combination	
N	Take off adapter (2) and impact extractor (3) at the nozzle holder combination (1)		
8.1	Take off seal (9).	All engines 903 and engine 906 up to end no. 056812  Pay attention to thickness of seal removed (produces nozzle projection relative to cylinder head contact surface).	
8.2	Pull off sealing sleeve (10) at nozzle holder combination (1)	Engine 906 as of end no. 056813  If sealing sleeve (10) is stuck: ↓ Pull sealing sleeve (10) out of the cylinder head.  Extraction tool  Threaded insert  Impact extractor	906 589 02 63 00 904 589 00 63 00 355 589 01 63 00
	Installing		
9	Replace O-ring (8) at the nozzle holder combination (1)	 Coat O-ring with lubricant.	BR00.45-Z-1018-06A
10.1	Fit on seal (9) at the nozzle holder combination (1)	All engines 903 and engine 906 up to end no. 056812  Replace sealing ring. Pay attention to installation position and thickness of seal; small ring surface on seal points toward nozzle holder combination.	
10.2	Press new sealing sleeve (10) onto the nozzle holder combination (1)	 Engine 906 as of end no. 056813	906 589 00 63 00
11	Install nozzle holder combination (1)	 Pay attention to installation position of nozzle holder combination relative to pressure pipe connection. Turn nozzle holder combination in cylinder head with the tensioning arm (7) until the interference-fit ball (arrow) in the tensioning arm is aligned with the locating element in the end cap (15) of the constant throttle.	
12.1	Bolt tensioning arm (7) and spherical washer (5) tight with bolt (4)	 Up to engine end no. 046892	BA07.15-N-1003-01A

12.2	Bolt tensioning arm (7) tight with spherical collar bolt (6)	As of engine end no. 046893	BA07.15-N-1003-01A
13	Replace O-ring (11) at pressure pipe connection (12)	Coat O-ring with lubricant.	BR00.45-Z-1018-06A
14	Install pressure pipe connection (12) and screw thrust bolt (13) tight	The interference-fit ball (arrow) at the pressure pipe connection must be inserted into the slot (arrow) in the cylinder head. 	BA07.15-N-1005-01A
15	Install injection line (14)		Page 27
16	Install cylinder head cover		AR01.20-W-5014A

Diesel injection system with unit pumps (PLD)

Number	Designation	Engine 904.9, 906.9
BA07.15-N-1003-01A	Screw of clamp of nozzle holder combination to cylinder head	Hexagon socket Nm 30
		Twelve-point with spherical collar 35
BA07.15-N-1005-01A	Thrust bolt of pressure pipe connection to cylinder head	Nm 40

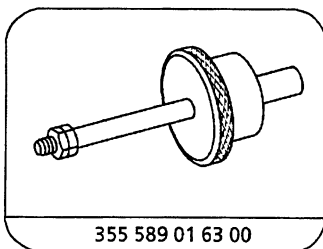

355 589 01 63 00

Impact extractor

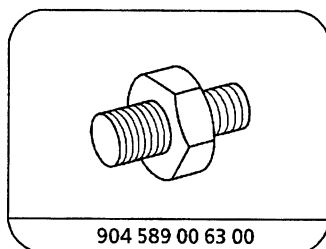

904 589 00 63 00

Threaded insert

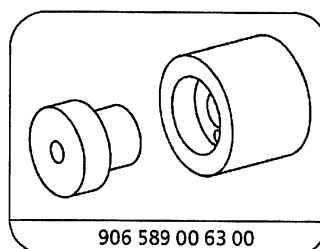

906 589 00 63 00

Assembly tool

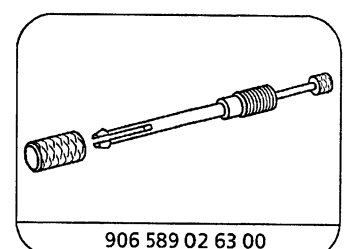

906 589 02 63 00

Extraction tool

Repair products

Number	Designation	Order no.
BR00.45-Z-1018-06A	ATE grease	-

ENGINE 904.905 /906 /907 /908 /909 /910 /911 /915 /916 /917 /921 /922 /923, 906.910 /911 /915 /916 /919 /920 /921 /922 /923 /925 /926 /927 /928 /939 /940 /941 /942 /943 /951 /952

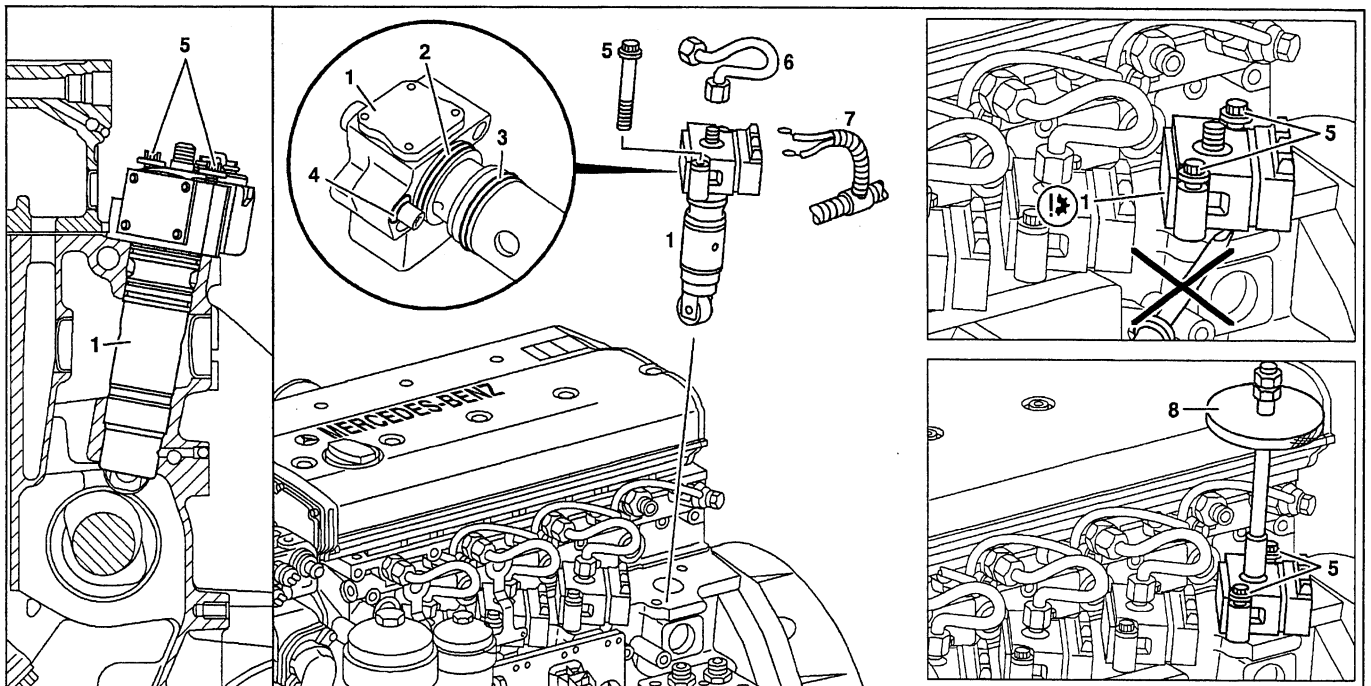

W07.15-0082-09

- 1 MR/PLD unit pump
- 2 O-ring
- 3 O-ring
- 4 O-ring

- 5 Serrated bolt
- 6 Injection line
- 7 Engine wiring harness
- 8 Impact extractor

- 1 MR/PLD unit pump
- 2 O-ring.
- 3 O-ring.
- 4 O-ring.
- 9 Protective sleeve

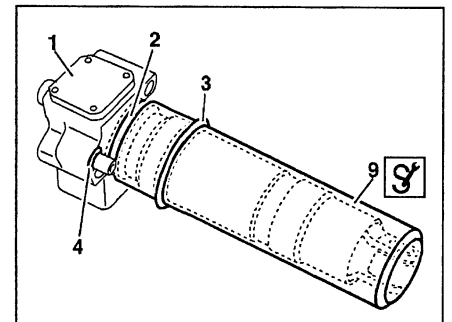













W07.15-1060-01

Modification notes

20.7.99	Assembly sequence modified	Step 11	
---------	----------------------------	---------	--

	Removing, installing		
Danger!	Risk of explosion from ignition, risk of poisoning from inhaling and swallowing fuel as well as risk of injury from skin and eye contact with fuel.	No fire, sparks, naked flames or smoking. Pour fuels only into suitable and appropriately marked containers. Wear protective clothing when handling fuel.	Page 29
1	Remove injection line (6)	Seal holes at nozzle holder combination and at MR/PLD unit pump (1).	Page 27

2	Take off fixture of hydraulic lines at cylinder head	 Only if removing the MR/PLD unit pump (1) of cylinder 1 at engine 906.920-923/925-928 fitted with "hydraulic" transmission shift code GS3.	
3	Clean engine in the area of the MR/PLD unit pump (1)		
4	Remove attachment strip for engine wiring harness together with start and stop switch at crankcase	 Only if removing MR/PLD unit pump of cylinder 1 or 2.	
5	Disconnect engine wiring harness (7) at MR/PLD unit pump (1)	 To do this, slacken bolts at solenoid valve and separate both clips.	
6	Mark MR/PLD unit pump (1) of the relevant cylinder	 Only if removing several or all MR/PLD unit pumps.	
N	Slacken serrated bolts (5)	<p> The serrated bolts must only be turned out about 4-5 mm for safety reasons; MR/PLD unit pump is tensioned by spring force.</p> <p> Installation: Install MR/PLD unit pump in the crankcase by slowly and alternately screwing in the serrated bolts.</p> <p> Tighten serrated bolts fully</p>	BA07.15-N-1001-01A
8	Fit on impact extractor (8) at the MR/PLD unit pump (1)		355 589 01 63 00
9	Use impact extractor (8) to pull out MR/PLD unit pump (1) as far as the bolt heads.	<p> An MR/PLD unit pump which is tight must not be pressed out at the solenoid valve or at the housing flange.</p> <p> Installation: Coat unit pump body, surface of O-rings (2, 3) and hole in the crankcase lightly with engine oil.</p> <p> Do not tilt MR/PLD unit pump when inserting into the crankcase.</p> <p>The fuel feed pipe at the MR/PLD unit pump can be used as a guide. Before pressing on the MR/PLD unit pump, ensure that the fuel feed pipe and the overflow hole are positioned one above the other. Carefully press in MR/PLD unit pump by hand against the force of the spring until the clearance is approx. 4 mm.</p> <p>If the unit pump cam at the camshaft is positioned at the top and it is not possible to press in the MR/PLD unit pump deep enough, rotate engine about 1/2 turn (in direction of rotation).</p>	
10	Unscrew serrated bolts (5) and pull out MR/PLD unit pump (1)	 Installation: Carefully remove dirt and varnish residues on the sealing surface of the MR/PLD unit pump and on the crankcase.	
11	Inspect MR/PLD unit pump	 Inspect roller at the roller tappet; if only minimal scores or scratches, the MR/PLD unit pump can continue to be used. If deep scores, scratches or grinding points: ↓	

		replace MR/PLD unit pump. ⓘ The unit pump body must not be disassembled.	
12	Remove O-rings (2, 3, 4) at the MR/PLD unit pump (1)	ⓘ Installation: Clean annular groove in the unit pump body. Coat new O-rings with engine oil. Push protective sleeve (9) over the unit pump body. First of all, roll the O-ring (2) over the protective sleeve (9) into the groove and then O-ring (3). ⓘ The O-rings (2, 3, 4) must not be installed in the grooves twisted. ⓘ	904 589 00 14 00
13	Install in the reverse order		

Nm Diesel injection system with unit pumps (PLD)

Number	Designation	Engine 904.9, 906.9
BA07.15-N-1001-01A	Bolt of PLD unit pump to crankcase	Nm 65

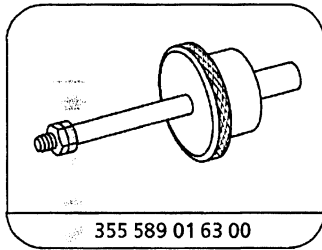

Impact extractor

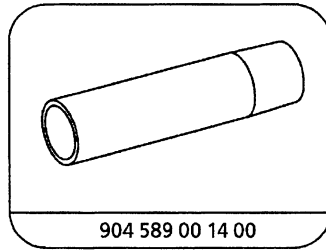

Sleeve

ENGINE 904.905 /906 /907 /908 /909 /910 /911 /921 /922 /923 ## up to 082245



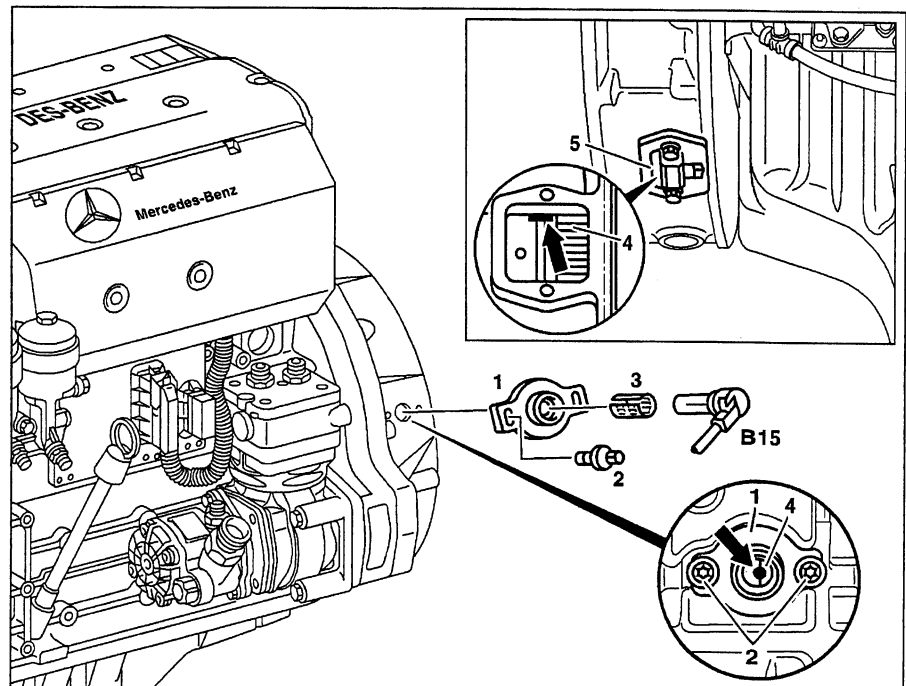

ENGINE 906.910 /911 /919 /920 /921 /922 /923 /940 /941 ## up to 082652

- 1 Bracket
- 2 Shear bolt
- 3 Locking bush
- 4 Flywheel
- 5  Cranking device

B15 Crank angle position sensor



W07.15-0081-06

	Removing		
 Danger!	Risk of injury from hand being jammed and bruised when tilting cab	No person must be within the tilting range of the cab when the cab is tilted. Always tilt cab as far as the end position and secure with safety prop.	Page 25
1.1	Tilt cab		
	Notes on tilting cab	Model 673- 679, 950- 954, 957, 970- 976	Page 26
1.2	Remove service cover	Model 668, 670	
2	Remove noise encapsulation panels		
3	Pull out crankshaft position sensor (B15) at bracket (1)		
4	Pull out locking bush (3)		
5	Remove end cover at timing case		
6	Attach cranking and blocking device (5) to timing case	 	Page 41 904 589 04 63 00 BA01.60-N-1002-01A
7	Rotate crankshaft with the cranking device	 Until a mounting hole (arrow) of the crank angle position sensor (B15) at the flywheel (4) is positioned in the middle.	
8	Block crankshaft to prevent it turning		
9	Mark flywheel (4) relative to edge in inspection hole		
10	Use a suitable tool to slacken and remove shear bolts (2), take off bracket (1)		

Adjusting			
11	Fit on bracket (1) and align	i Marking on flywheel (4, arrow) must be positioned in the middle of the mounting hole of the crankshaft angle position sensor (B15). Inspect marking on flywheel (4) relative to edge in inspection hole.	
12	Tighten shear bolts (2) fully until they shear off		
⊠	Installing		
13	Press in locking bush (3) as far as the stop		
14	Press crankshaft angle position sensor (B15) into the timing case as far as the stop.		
15	Remove blocking and cranking device (5)		
16	Fit end cover onto timing case	Nm	BA01.60-N-1002-01A
17	Install noise encapsulation		
18.1	Tilt cab back to driving position	Model 673- 679, 950- 954, 957, 970- 976	
18.2	Install service cover	Model 668, 670	

Nm Timing case

Number	Designation	Engine
BA01.60-N-1002-01A	End cover of inspection hole to timing case	Nm 25

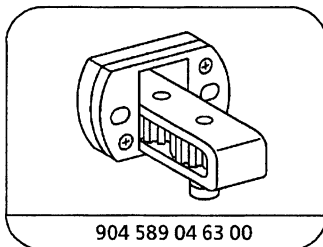

904 589 04 63 00

Cranking device



AR03.30-W-1600-03A	Attaching, detaching cranking/blocking device for engine		
--------------------	--	--	--

Nm Timing case

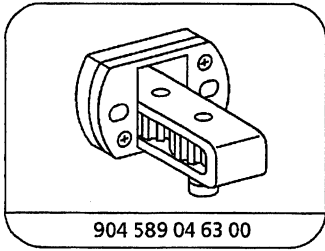
Number	Designation	Engine
BA01.60-N-1002-01A	End cover of inspection hole to timing case	Nm 25



Cranking device

- 1 Remove noise encapsulation below flywheel housing.
- 2 Remove cover (1) at flywheel housing (if fitted).
- 3  Attach cranking and blocking device (2) tight to flywheel housing with bolts (4).
-  Cranking and blocking device (2) can be blocked by inserting the pin (3).
-  Cranking and blocking device (2) must be removed before starting the engine.

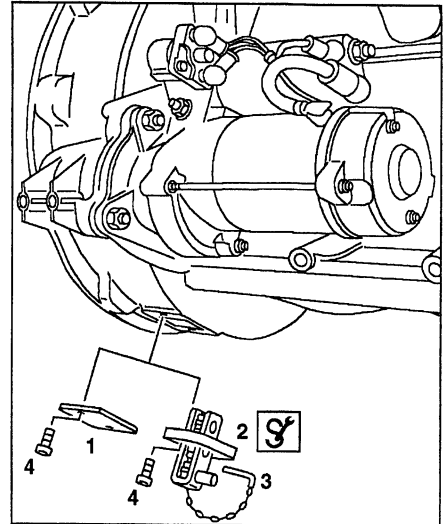

W03.30-0001-02

ENGINE 904.905 /906 /907 /921 ## up to 040487

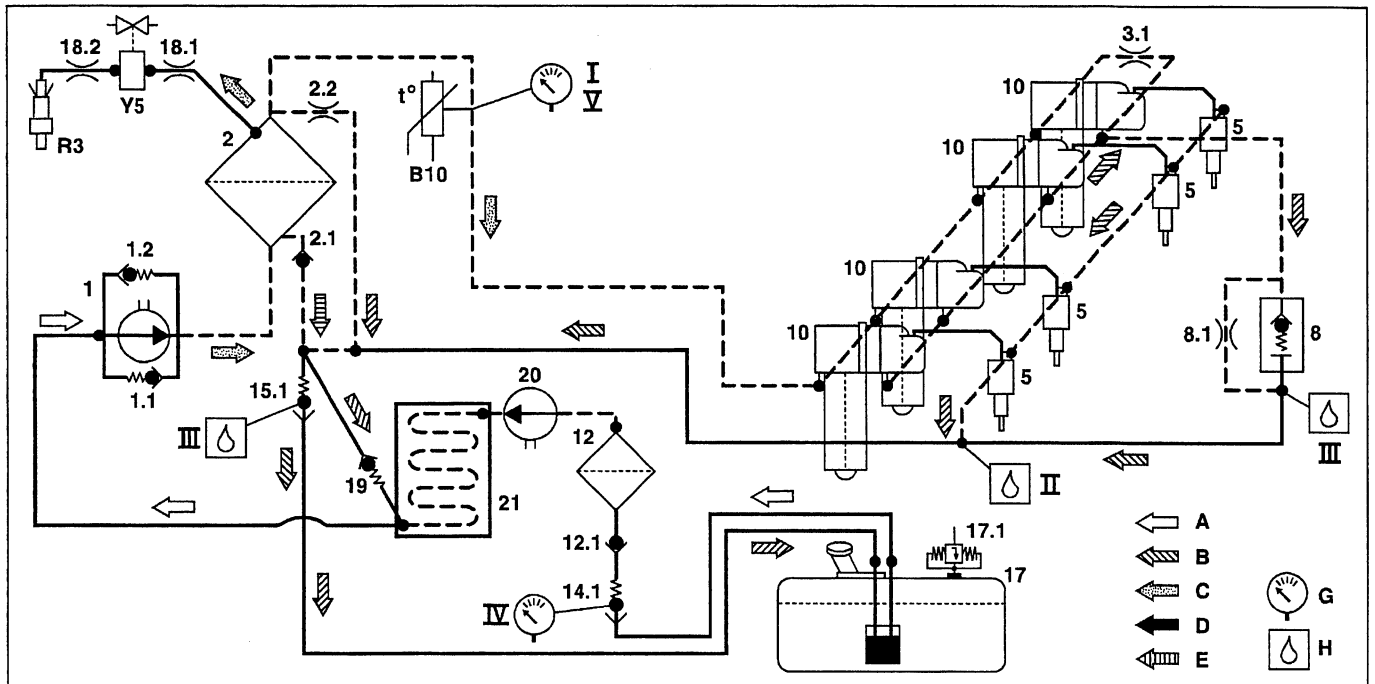

W07.15-1014-09

- 1 Fuel delivery pump (KFP)
- 1.1 Pressure limiting valve in fuel delivery pump (9.2 bar)
- 1.2 Check valve in fuel delivery pump (0.2 bar)
- 2 Fuel filter (KF)
- 2.1 Fuel filter drain valve
- 2.2 Continuous vent in fuel filter (as of engine end no. 027674)
- 3.1 Bypass from fuel feed passage to fuel return flow passage
- 5 Nozzle holder combination
- 8 Overflow valve up to engine end no. 002 604 6.5 bar
as of engine end no. 002 605 4.5 bar
- 8.1 Continuous vent (0.5 mm)
- 10 PLD unit pumps (Y6 to Y11)
- 12 Fuel prefilter (KVF)
- 12.1 Check valve in fuel prefilter
- 14.1 Assembly valve in fuel feed (pressure-opened)
- 15.1 Assembly valve in fuel return flow (pressure-opened)
- 17 Fuel tank
- 17.1 Air admission valve
- 18.1 Restrictor (0.5 mm) in flame fuel line

- 18.2 Restrictor (threaded restrictor) in flame fuel line
- 19 Bypass line with valve
- 20 Fuel hand priming pump
- 21 Fuel heat exchanger
- B10 Fuel temperature sensor
- R3 Flame glow plug
- Y5 Solenoid valve

Fuel circuit

- A Fuel feed (suction-vacuum side)
- B Fuel return flow (leak fuel)
- C Fuel feed (pressure side)
- D Fuel high pressure side (downstream of PLD unit pumps)
- E Fuel return flow (fuel filter drain)

---- Fuel passages in crankcase

— Fuel lines

Test positions, test data

G Pressure gage test

H Fuel return flow quantity test

I Fuel pressure downstream of fuel filter

Idle speed: up to engine end no. 002604 ≥ 6.0 bar,
as of engine end no. 002605 ≥ 4.3 bar

Governed speed: up to engine end no. 002604 6.2-7.5 bar,
as of engine end no. 002605 4.0-6.5 bar

II Fuel return flow quantity at nozzle holder combinations

Test time: 5 min

Idle speed: oil-moist

Governed speed: max. only drops

III Fuel return flow quantity at fuel filter housing outlet

Idle speed and governed speed:

up to engine end no. 027673 ≤ 0.1 l/min

as of engine end no. 027674 ≤ 0.3 l/min

Fuel return flow quantity at overflow valve

Idle speed: up to engine end no. 027673 0.9-1.4 l/min

as of engine end no. 027674 0.9-1.7 l/min

Governed speed: up to engine end no. 027673 2.0-4.0 l/min

as of engine end no. 027674 2.7-7.5 l/min

IV Fuel inlet pressure upstream of fuel pump

Idle speed: -0.09 to -0.12 bar

Governed speed: ≈ -0.35 bar

V Low pressure fuel circuit leaktightness

Test pressure: 5.0 bar

Test time: 5 min

Pressure drop: ≤ 0.1 bar

Diagram of fuel circuit

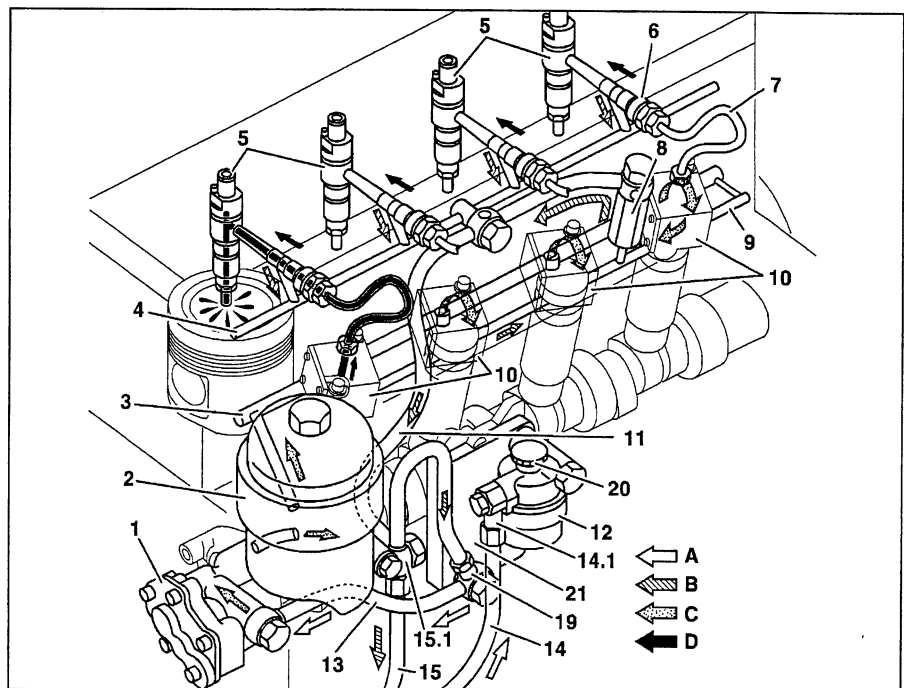

W07.15-1016-06

1 Fuel delivery pump (KFP)

2 Fuel filter (KF)

3 Fuel feed passage to PLD unit pumps

4 Leak fuel passage

5 Nozzle holder combination

6 Pressure pipe connection

7 Injection line

8 Overflow valve

9 Fuel return flow passage - scavenging fuel of PLD unit pumps

10 PLD unit pumps (Y6 to Y11)

11 Return flow - leak fuel line

12 Fuel prefilter (KVF)

13 Fuel line to fuel delivery pump

14 Fuel feed from fuel tank

14.1 Assembly valve in fuel feed

15 Fuel return flow to fuel tank

15.1 Assembly valve in fuel return flow

19 Bypass valve

20 Fuel hand priming pump

21 Fuel heat exchanger



















A Fuel feed











B Fuel return flow/leak fuel

C Fuel feed (pressure side downstream of fuel delivery pump and fuel filter)

D Fuel high pressure side

	Removing, installing	
--	-----------------------------	--

 Danger! 1 	Risk of injury from hand being jammed and bruised when tilting cab Tilt cab Notes on tilting cab	No person must be within the tilting range of the cab when the cab is tilted. Always tilt cab as far as the end position and secure with safety prop. Model 670-679	Page 25 Page 26
2	Remove noise encapsulation on the side at left		
 Danger!	Risk of explosion from ignition, risk of poisoning from inhaling and swallowing fuel, as well as risk of injury from skin and eye contact with fuel.	No fire, sparks, naked flames or smoking. Pour fuels only into suitable and appropriately marked containers. Wear protective clothing when handling fuel.	Page 29
3	Carry out visual inspection at all fuel lines, bolted connections and components	 Run engine at governed speed for about 2-3 minutes. Replace damaged or leaking parts. Retighten bolted connections, if necessary.	
4	Inspect fuel prefilter element	 Replace fuel prefilter element, if necessary.	WH0730
5	Inspect fuel filter element	 Replace fuel filter element, if necessary.	WH0780.30
6	 AD Connect diagnostic system  AD Connect Hand-Held Tester (HHT) and read out fault memory Connect STAR DIAGNOSIS, interrogate fault memory	All models Model 950-954, 957, 970-976	Page 47 Page 47
7	Re-set parameter of stationary speed limit to 4000 rpm	 Only engines fitted with stationary speed limit. Note parameterized value.  Installation: Restore parameter of stationary speed limit to original setting.	
	Inspecting		
	Conditions for tests	Engine must be at operating temperature. Fuel temperature in fuel tank $\leq 40^{\circ}\text{C}$. Collect fuel which flows out. The fuel which flows through during the tests must be free of bubbles.	
8	Open cap at fuel tank		
9	 AD  AD	Test fuel pressure downstream of fuel filter Attach test and measuring instruments to the low pressure fuel circuit Perform test up to engine end no. 002604 as of engine end no. 002605   	Page 50 Page 51 Page 51 123 589 04 21 18 541 589 02 21 00 541 589 00 91 00
10	 AD	Measure fuel return flow quantity at nozzle holder combinations Attach test and measuring instruments to the low pressure fuel circuit Perform test 	Page 52 Page 53 000 589 07 03 00

		 	000 589 68 03 00 541 589 00 91 00 BA07.15-N-1004-01A BA07.15-N-1006-01A
11	Measure fuel return flow quantity at engine	 Injection line to pressure pipe connection and unit pump.  Banjo bolt of fuel line to cylinder head.  If the fuel return flow quantity is within the tolerance range, it is not necessary to carry out any further tests.	Page 53 Page 55 Page 56 541 589 00 91 00 BA07.15-N-1007-01A
12	Test fuel inlet pressure upstream of fuel pump	Attach test and measuring instruments to the low pressure fuel circuit Perform test Up to engine end no. 027673 As of engine end no. 027674   Banjo bolt of fuel line to fuel pressure relief valve.	Page 57 Page 57 617 589 04 21 00 541 589 00 91 00
13	Test low pressure fuel circuit in engine for leaks	Attach test and measuring instruments to the low pressure fuel circuit Perform test   	Page 58 Page 59 123 589 04 21 18 541 589 02 21 00 541 589 00 91 00
14	Install in the reverse order		
15	Bleed fuel system		
16	Test vehicle performance on chassis dynamometer	 Only after all tests or measurements have been completed and any defects rectified: ↓ If no improvement has been achieved in fuel consumption or performance, it is then necessary to connect a fuel consumption measuring system.	

 Diesel injection system with unit pumps (MR/PLD)

Number	Designation		Engine 904.9, 906.9
BA07.15-N-1004-01A	Injection line to pressure pipe connection of unit pump	Nm	25
BA07.15-N-1006-01A	Banjo bolt of fuel line to cylinder head	Nm	40
BA07.15-N-1007-01A	Banjo bolt of fuel line to overflow valve	Nm	40

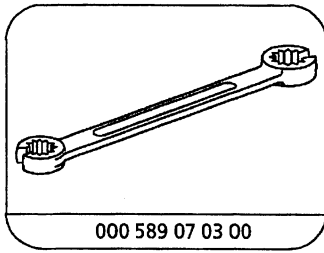

000 589 07 03 00

Ring wrench

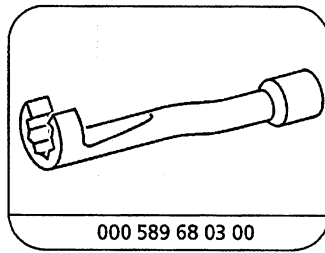

000 589 68 03 00

Ring wrench bit

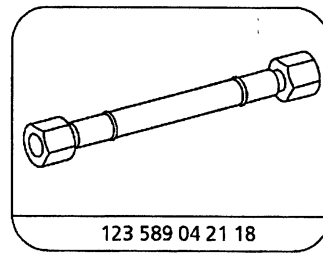

123 589 04 21 18

High-pressure hose

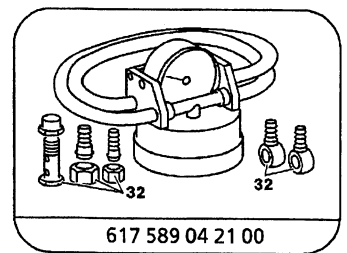

617 589 04 21 00

Tester

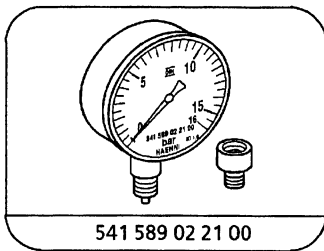

541 589 02 21 00

Tester

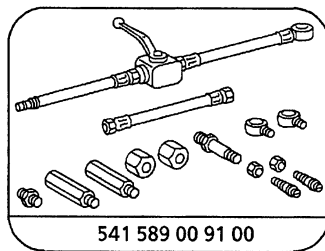

541 589 00 91 00

Adaption parts

AD00.00-W-2000-03A	Connecting hand-held tester (HHT), reading fault memory	All models	
--------------------	---	------------	--

- 1 HHT
- 2 Multiplexer
- 3 Adapter cable
- 4 Diagnostic socket

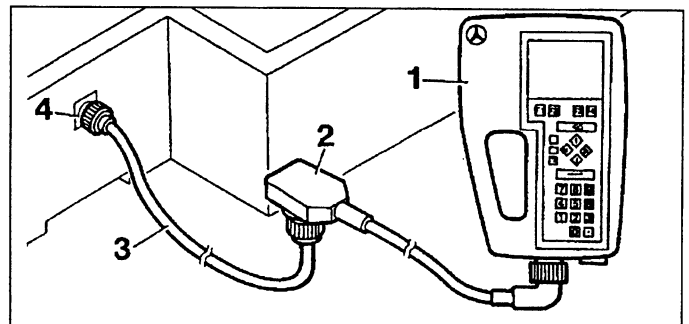

W54.00-0068-10

- a Ignition: **OFF**
- b First of all, connect multiplexer (2) and adapter cable (3) to the HHT (1).
- c Then, connect adapter cable (3) to the diagnostic socket (4).
 - ⚠ Failure to adhere to the order of steps described can result in damage to the multiplexer.
 - The HHT program recognizes the control module type.

- d Ignition: **ON**
- e Start test program (refer to operating instructions of HHT).

i Pay attention to system-specific variations which are listed in the section "Basic knowledge of diagnosis" for the particular diagnosis description.
Stored faults which may be caused by disconnected cables or by simulation during test operations, must be erased in the fault memory after completing the work.

AD00.00-W-2000-04A	Connect STAR DIAGNOSIS, read fault memory		
--------------------	---	--	--

Workshop equipment/MB testers (see Workshop Equipment Manual)

WE58.40-Z-1014-06A	Diagnosis System STAR DIAGNOSIS Compact for CV, order number 6511 1811 02
--------------------	---

- 1 Connect Diagnosis System STAR DIAGNOSIS (1) to diagnostic socket (2).
- 2 Switch on ignition.
- 3 Start DAS (Diagnosis Assistant System) application.

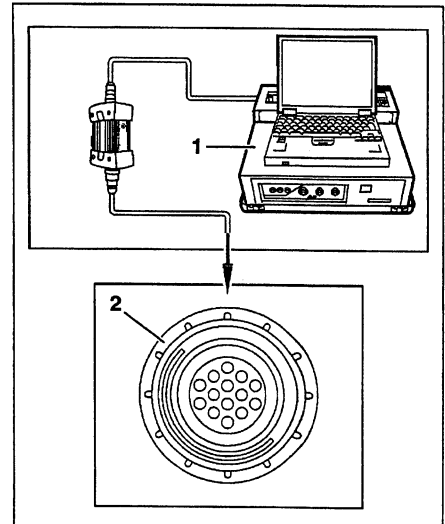

W00.30-1001-02

- 4 Select Trucks range.
- 5 Press "F3 key" once.

Model series/model designation	<input type="text"/>	ECM channel 1	<input type="text"/>
Range selection			
Buses			
Trucks X			
Passenger cars			
Transporters or V-class			
Unimog			
Industrial engines			
ESC	F1	F3	F11

- 6 Select vehicle.
- 7 Press "F3 key" once.

Model series/model designation	<input type="text"/>	ECM channel 1	<input type="text"/>
Vehicle selection.			
ACTROS			
ACTROS trial vehicles			
ATEGO (6.5 - 15 t)			
ATEGO (18 - 26 t)			
ECONIC			
FSK			
Other commercial vehicles			
<div style="display: flex; justify-content: space-around; align-items: center;"> <div style="border: 1px solid black; padding: 5px 15px;">ESC</div> <div style="border: 1px solid black; padding: 5px 15px;">F1</div> <div style="border: 1px solid black; padding: 5px 15px;">F3</div> <div style="border: 1px solid black; padding: 5px 15px;">F6</div> <div style="border: 1px solid black; padding: 5px 15px;">F11</div> </div>			

- 8 Select "Quick test".
- 9 Perform a quick test depending on model to be tested using HHT-WIN or DAS, and compile an incoming test report, if necessary.
 - The procedure for performing quick tests is well known so that no further descriptions are given here.
- 10.1 End HHT-WIN program and press "F2 key" once.
 - HHT-WIN has not ended until the HHT-WIN program window is closed.
- 10.2 Press "F1 key" once.

Model series/model designation	<input type="text" value="ACTROS"/>	ECM channel 1	<input type="text"/>
System recognition ACTROS			
Quick test X			
System recognition			
Special functions			
Direct access to APS (Auto-Pilot-System) control unit			
Record diagnostic and repair data (product performance data).			
<div style="display: flex; justify-content: space-around; align-items: center;"> <div style="border: 1px solid black; padding: 5px 15px;">ESC</div> <div style="border: 1px solid black; padding: 5px 15px;">F1</div> <div style="border: 1px solid black; padding: 5px 15px;">F3</div> <div style="border: 1px solid black; padding: 5px 15px;">F11</div> </div>			

AR07.15-W-2000-01I

Installing test/measuring equipment in low pressure fuel circuit

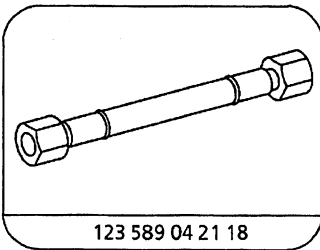

123 589 04 21 18

High-pressure hose

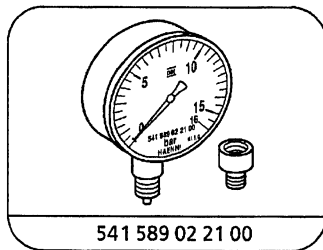

541 589 02 21 00

Tester

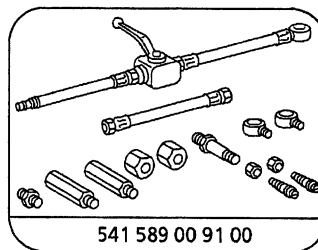

541 589 00 91 00

Adaption parts

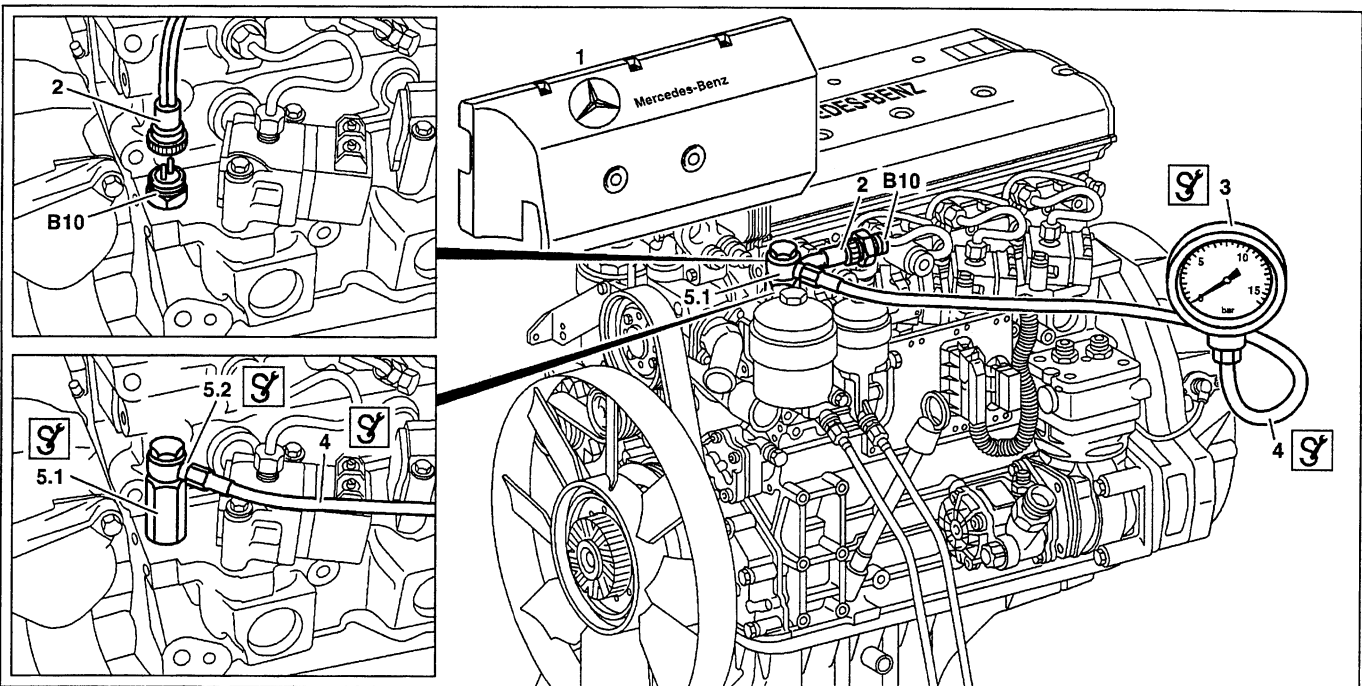

W07.15-1006-09

Shown on engine 904.909

- 1 If MPS or HPS shift fitted:
Unscrew bottom bolt at bracket of cylinder head.
- 2 Remove engine panel (1).
- 3 Remove fuel temperature sensor (B10).
- 4 Install adapter (5.1) together with seal at crankcase.
- 5 Attach banjo union (5.2), pressure gage (3) and test hose (4) to adapter piece (5.1).
- 6 Connect removed fuel temperature sensor (B10) to the engine wiring harness (2) and tie up at engine.

AD07.15-W-7001-01D	MR (PLD) test of hydraulic system fuel pressure downstream of fuel filter	Engines 904.904-908/921 up to engine end No. 002604	
--------------------	---	---	--

⇒	Scope of test	Measuring instrument/ Test connection	Operation/Requirement	Specified value	● Possible cause/Remedy
1.0	Check fuel pressure downstream of fuel filter Install testers and measuring instruments in low pressure fuel circuit &(AR07.15-W-2000-01I)		Engine: Start Idle speed 600 - 650 rpm: Breakaway speed 2500 rpm:	≥ 6.0 bar 6.2 to 7.5 bar	<ul style="list-style-type: none"> ● Fuel pressure too high &(AD07.15-W-5001-09F) ● Fuel pressure too low &(AD07.15-W-7001-06D) ● Fuel pressure within tolerance range &(AD07.15-W-7001-07F)

AD07.15-W-7001-01F	MR (PLD) test of hydraulic system fuel pressure downstream of fuel filter	Engine 904.904-908/921, as of end no. 002605 Engine 904.909-911/915-917/922/923/941, 906.910/911/915/916/919-923/925-928/939/940/941/942/943/951/952	
--------------------	---	---	--

⇒	Scope of test	Tester/test connection	Operation/Requirement	Specified value	● Possible cause/Remedy
1.0	Test fuel pressure downstream of fuel filter Attach test and measuring equipment to low pressure fuel circuit &(AR07.15-W-2000-01I)		Engine: start Idle speed 600 - 650 rpm: Governed speed 2500 rpm:	≥ 4.3 bar 4.0 to 6.5 bar	<ul style="list-style-type: none"> ● Fuel pressure too high &(AD07.15-W-5001-09F) ● Fuel pressure too low Up to engine end no. 027673, except engine 904.904/908 up to end no. 027210 &(AD07.15-W-7001-06D) As of engine end no. 027674, except engine 904.904/908 as of end no. 027211 &(AD07.15-W-7001-06F) ● Fuel pressure within tolerance range &(AD07.15-W-7001-07F)

AR07.15-W-2000-01L	Installing test/measuring equipment in low pressure fuel circuit		
--------------------	--	--	--

Nm Diesel injection system with unit pumps (MR/PLD)

Number	Designation	Engine 904.9, 906.9
BA07.15-N-1004-01A	Injection line to pressure pipe connection of unit pump	Nm 25
BA07.15-N-1006-01A	Banjo bolt of fuel line to cylinder head	Nm 40

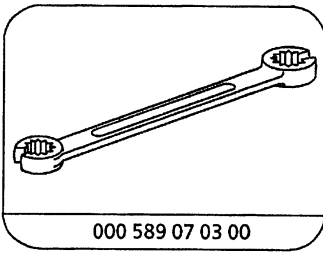

Ring wrench

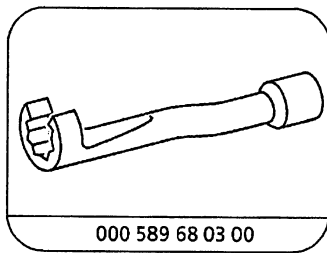

Ring wrench bit

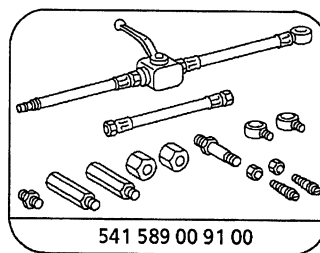

Adaption parts

Shown on engine 904.909

- 1 Remove engine panel.
- 2 Remove injection line.
 - i** Engine 904 at cylinder 2;
Engine 906 at cylinder 4.
- 3 Remove fuel return flow line (2) at cylinder head (leak oil drilling) and attach adapter piece (3.1) with fuel return flow line (2).
 - i** Install U-seal or U-sit sealing rings (3.2) between fuel return flow line and cylinder head.
- 4 Install injection line.
- 5 Place clean cloth below adapter piece (3.1) and collect any leak fuel which flows out.

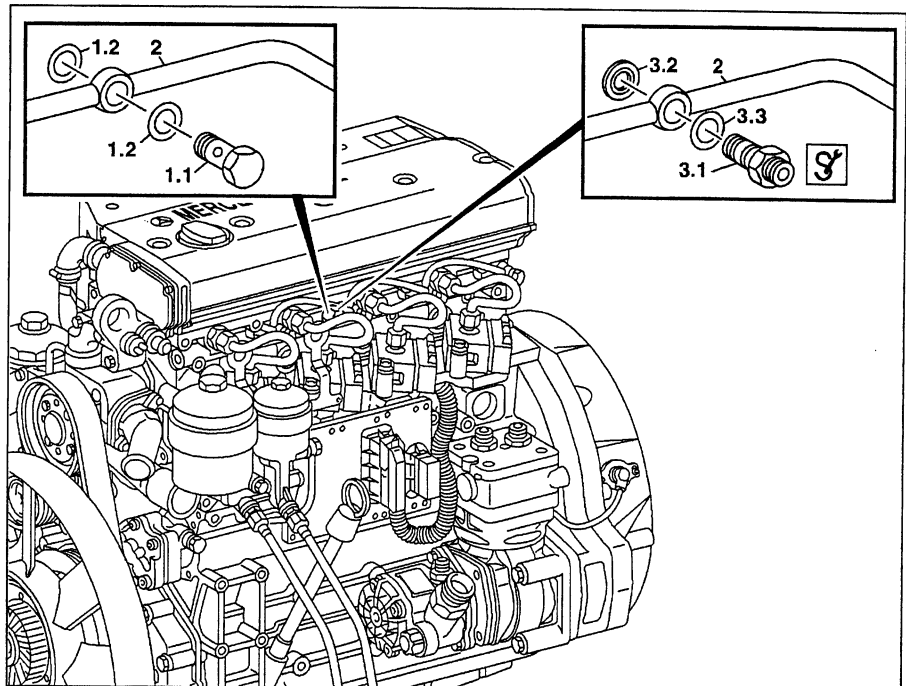

W07.15-1007-06

AD07.15-W-7001-07F	MR (PLD) test of hydraulic system fuel return flow quantity at nozzle holder combinations		
--------------------	---	--	--

⇒	Scope of test	Tester/test connection	Operation/ Requirement	Specified value	● Possible cause/ Remedy
1.0	Test fuel return flow quantity at nozzle holder combinations Attach test and measuring equipment to low pressure fuel circuit &(AR07.15-W-2000-01L)		Engine: start Idle speed 600 - 650 rpm: Test time 5 minutes: Governed speed 2500 rpm: Test time 5 minutes:	oil moist max. only drips	● Fuel and coolant outlet at leak oil drilling or leak oil line &(AD07.15-W-5001-05F)

AR07.15-W-2000-01N	Installing test/measuring equipment in low pressure fuel circuit		
--------------------	--	--	--

Nm Diesel injection system with unit pumps (MR/PLD)

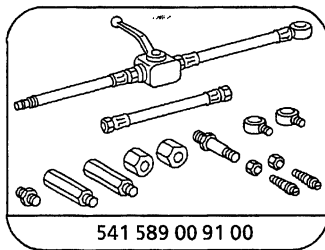

Number	Designation	Engine 904.9, 906.9
BA07.15-N-1007-01A	Banjo bolt, fuel line to bypass valve	Nm 40

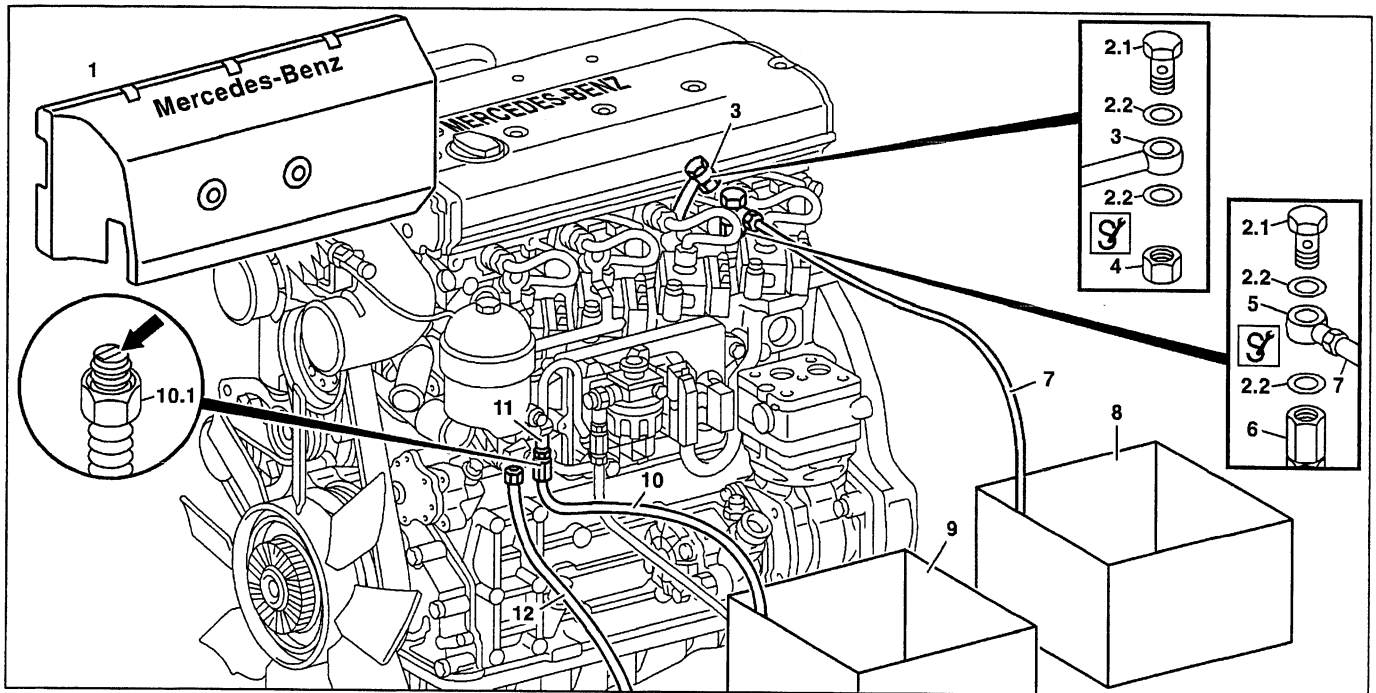

Adaption parts



W07.15-1013-09

- 1 Remove engine compartment lining (1).
- 2 Disconnect fuel return line (3) on bypass valve (6).
 - ⓘ Steady bypass valve (6) when loosening the fuel return line (3).
- 3 Seal fuel return line (3) with banjo bolt (2.1) and  lock nut (4).
- 4 Detach  ring piece (5) from bypass valve (6).
 - ⓘ Steady bypass valve (6) when tightening bolts.
- 5 Install transparent fuel line (7) on  ring piece (5) and guide into a clean container (8).
- 6 Disconnect fuel return line (12) on connection (11) and install transparent fuel line (10).
 - ⓘ The support (10.1) with opening clamp (arrow) must press the non-return valve into the connection (11).
- 7 Guide fuel return line (10) into a clean container (9).

AD07.15-W-7001-06D	MR (PLD) test of hydraulic systems fuel return flow quantity	Engines 904.905-907/921 up to engine end NO. 027673 Engine 904.904/908 up to engine end NO. 027210	
--------------------	--	---	--

⇒	Scope of test	Measuring instrument/ Test connection	Operation/Requirement	Specified value	● Possible cause/Remedy
1.0	Fuel return flow quantity at fuel filter housing outlet Install testers and measuring instruments in low pressure fuel circuit &(AR07.15-W-2000-01N)		Engine: Start Idle speed 600 - 650 rpm Measuring time > 1 minute Breakaway speed 2500 rpm Measuring time > 30 seconds: Measuring point: Bypass valve	≤ 0.1 l/min ≤ 0.1 l/min	● Fuel return flow quantity at bypass valve too low, within tolerance range at fuel filter housing outlet &(AD07.15-W-5001-08A) ● Fuel return flow quantity at bypass valve too low, too high at fuel filter housing outlet &(AD07.15-W-5001-08B)
1.1	Fuel return flow quantity at bypass valve		Engine: Start Idle speed 600 - 650 rpm Measuring time > 1 minute Breakaway speed 2500 rpm Measuring time > 30 seconds:	0.9 – 1.4 l/min 2.0 – 4.0 l/min	● Fuel return flow quantity at bypass valve, within tolerance range at bypass valve and fuel filter housing outlet &(AD07.15-W-5001-08D) ● Fuel return flow quantity at bypass valve and fuel filter housing outlet too low &(AD07.15-W-7001-03D)

AD07.15-W-7001-06F	MR (PLD) test of hydraulic systems fuel return flow quantity	Engine 904.905-907/921 as of end no. 027674, engine 904.904/908 as of end no. 027211, Engine 904.909-911/915-917/922/923/941, 906.910/911/915/916/919-923/925-928/939/940/941/942/943/951/952	
--------------------	--	---	--

⇒	Scope of test	Tester/test connection	Operation/ Requirement	Specified value	● Possible cause/ Remedy
1.0	Fuel return flow quantity at outlet of fuel filter housing Attach test and measuring equipment to low pressure fuel circuit &(AR07.15-W-2000-01K)		Engine: start Wait until fuel flows out practically free of bubbles from the test fuel line Idle speed 600 - 650 rpm Measuring time > 1 minute Governed speed 2500 rpm Measuring time > 30 seconds: Measuring point: Overflow valve	≤ 0.3 l/min ≤ 0.3 l/min	● Fuel return flow quantity too low at overflow valve, within tolerance range at outlet of fuel filter housing &(AD07.15-W-5001-08A) ● Fuel return flow quantity too low at overflow valve and too high at outlet of fuel filter housing &(AD07.15-W-5001-08B)
1.1	Fuel return flow quantity at overflow valve		Engine: start Idle speed 600 - 650 rpm Measuring time > 1 minute Governed speed 2500 rpm Measuring time > 30 seconds	0.9 - 1.7 l/min 2.7 - 7.5 l/min	● Fuel return flow quantity o.k. at overflow valve and cannot be measured at outlet of fuel filter housing &(AD07.15-W-5001-08C) ● Fuel return flow quantity within tolerance range at overflow valve and at outlet of fuel filter housing &(AD07.15-W-5001-08D) ● Fuel return flow quantity too low at overflow valve and at outlet of fuel filter housing &(AD07.15-W-7001-03F)

AR07.15-W-2000-01P	Installing test/measuring equipment in low pressure fuel circuit		
--------------------	--	--	--

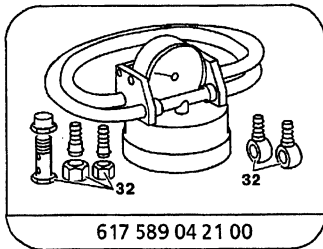

Tester

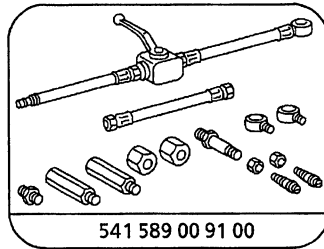

Adaption parts

- 1 Install tester (2) with test cables (2.1) and connectors (2.3) between fuel supply line (3) and connection (1.1) to fuel prefilter housing (1).

- The support (2.2) with opening clamp (arrow) must press the non-return valve into the connection (1.1).
- Check sealing ring on support (2.2) for damage and replace if necessary.

- 2 Bleed fuel system.

- 3 Attach tester (2) to frame.

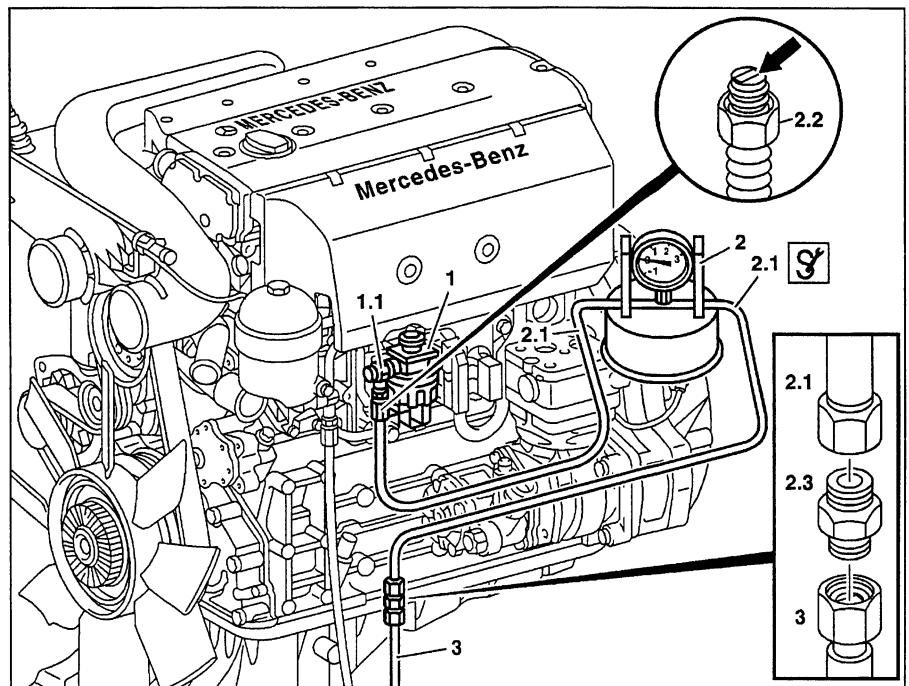

W07.15-1009-06

AD07.15-W-7001-03D	MR (PLD) test of hydraulic system fuel intake pressure upstream of fuel pump	Engines 904.904- 908/921, up to engine end no. 040487	
--------------------	--	---	--

⇒	Scope of test	Measuring instrument/ Test connection	Operation/Requirement	Specified value	● Possible cause/Remedy
1.0	Check fuel intake pressure upstream of fuel pump Install testers and measuring instruments in low pressure fuel circuit &(AR07.15-W-2000-01P)		Engine: Start Idle speed 600 - 650 rpm: Breakaway speed 2500 rpm:	-0.09 to -0.12 bar ≈ -0.35 bar	● Fuel intake pressure too low (→ 0 bar) &(AD07.15-W-5001-01D) ● Fuel intake pressure too high (→ -1 bar) &(AD07.15-W-5001-02F)

AR07.15-W-2000-01S

Installing test/measuring equipment in low pressure fuel circuit

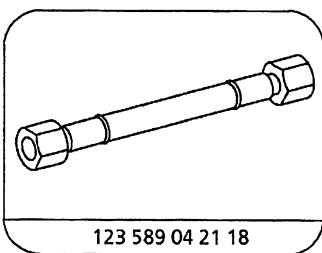

123 589 04 21 18

High pressure hose

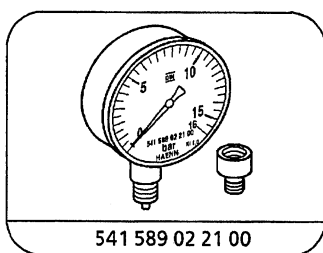

541 589 02 21 00

Tester

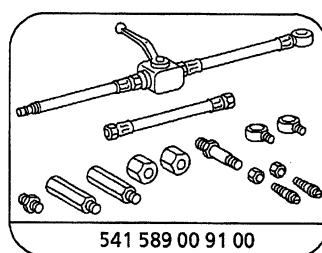



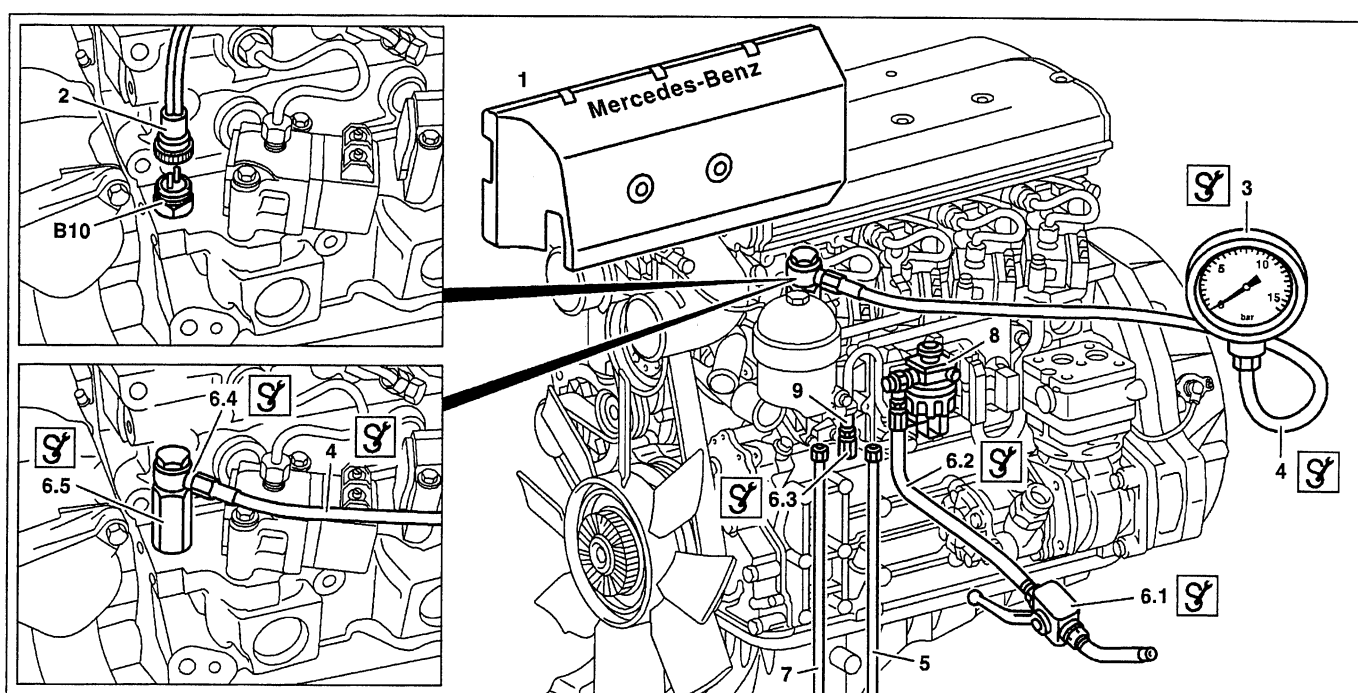

541 589 00 91 00

Adaption parts



W07.15-1011-09

- 1 Remove engine compartment lining (1).
- 2 Remove fuel temperature sensor (B10).
- 3 Install  adapter piece (6.5) with sealing ring on crankcase.
- 4 Install  ring piece (6.4), measuring hose (4) and pressure gauge (3) on adapter piece (6.5).
- 5 Detach fuel return line (7) on connection (9) and seal with  cap (6.3).
- 6 Detach fuel supply line (5) on fuel prefilter housing (8) connection and install  connection line (6.2) with  shut-off cock (6.1).

AD07.15-W-7001-08D	MR (PLD) test of hydraulic system low pressure fuel circuit leaks	Engines 905.904-908/921 up to engine end no. 040487	
--------------------	---	---	--

⇒	Scope of test	Measuring instrument/ Test connection	Operation/Requirement	Specified value	● Possible cause/Remedy
1.0	Check low pressure fuel circuit for leaks Install testers and measuring instruments in low pressure fuel circuit &(AR07.15-W-2000-01S)		Fill low pressure fuel circuit in engine with compressed-air Fuel circuit without PLD heat exchanger Test pressure 5.5 bar: Test time 5 minutes:	$\leq 0.1 \text{ bar}$	● with greater drop in pressure or fuel in engine oil &(AD07.15-W-5001-06F)

Test points, test data

G Pressure gage test

H Fuel return flow quantity test

I Fuel pressure downstream of fuel filter

Idling speed: ≥ 4.3 bar

Governed speed: 4.0-6.5 bar

II Fuel return flow quantity at nozzle holder combinations

Test time: 5 min

Idling speed: oil-moist

Governed speed: max. only drips

III Fuel return flow quantity at fuel filter housing outlet

Idling speed and governed speed: ≤ 0.3 l/min

Fuel return flow quantity at overflow valve

Idling speed: 0.9-1.7 l/min

Governed speed: 2.7-7.5 l/min

IV Fuel inlet pressure upstream of fuel pump

Idling speed: -0.09 to -0.12 bar

Governed speed: -0.4 to -0.5 bar

V Low pressure fuel circuit leaks

Test pressure 10 bar, test time: 5 min,

pressure drop ≤ 0.25 bar





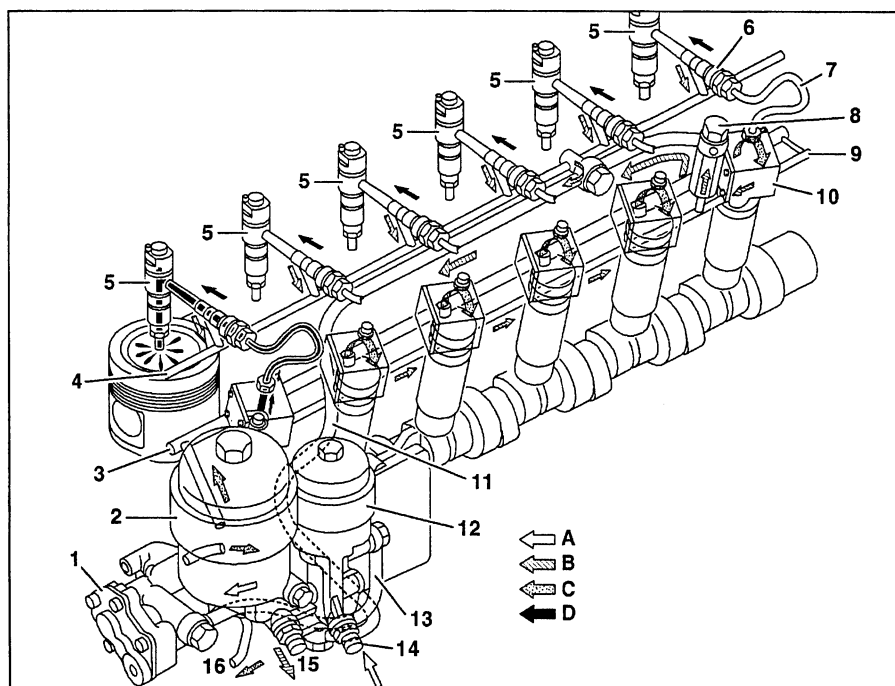







Diagram of fuel circuit

















Shown on engine 906



W07.15-0083-06

- | | | |
|---------------------------------------|--|--|
| 1 Fuel delivery pump (KFP) | 8 Overflow valve (4.5 bar) | 15 Fuel return flow to tank |
| 2 Fuel filter (KF) | 9 Fuel return flow passage - scavenging fuel of PLD unit pumps | 16 Fuel feed to flame starting system |
| 3 Fuel feed passage to PLD unit pumps | 10 PLD unit pumps (Y6 to Y11) | A Fuel feed |
| 4 Leak oil passage | 11 Return flow leak fuel line | B Fuel return flow/leak fuel |
| 5 Nozzle holder combination | 12 Fuel prefilter (KVF) | C Fuel feed (pressure side downstream of fuel delivery pump and fuel filter) |
| 6 Pressure pipe connection | 13 Fuel line fuel prefilter to fuel delivery pump | D Fuel high pressure side (downstream of PLD unit pumps) |
| 7 Injection line | 14 Fuel feed from tank | |

	Removing, installing		
 Danger!	Risk of injury from hand being jammed and bruised when tilting cab	No person must be within the tilting range of the cab when the cab is tilted. Always tilt cab as far as the end position and secure with safety prop.	Page 25
1	Tilt cab		
	Notes on tilting cab	Model 375, 670-679, 950-954, 957, 970-976	Page 26
2	Remove noise encapsulation at left side		
 Danger!	Risk of explosion from ignition, risk of poisoning from inhaling and swallowing fuel, as well as risk of injury from skin and eye contact with fuel.	No fire, sparks, naked flames or smoking. Pour fuels only into suitable and appropriately marked containers. Wear protective clothing when handling fuel.	Page 29
3	Carry out visual inspection at all fuel lines, bolted connections and components	 Run engine for about 2-3 minutes at governed speed. Replace damaged or leaking parts. Re-tighten bolted connections, if necessary.	
4	Inspect fuel prefilter element	 Replace fuel prefilter element, if necessary.	AP47.20-W-0730B
 AP			
5	Inspect fuel filter element	 Replace fuel filter element, if necessary.	AP47.20-W-0780B
 AP			
6	Connect diagnostic system Connect STAR DIAGNOSIS, interrogate fault memory	Model 375, 950-954, 957, 970-976	Page 47
 AD			
N	Reset parameter of stationary speed limit to 4000 rpm	 Only engines fitted with stationary speed limit. Note parameterized value.  Installation: Restore parameter of stationary speed limit to original setting.	
	Inspecting		
	Conditions for tests	If Racor fuel prefilter fitted, take this off and connect fuel lines at fuel prefilter. Engine must be at normal operating temperature. Fuel temperature in fuel tank ≤ 40 °C. Collect fuel which flows out. The fuel which flows through during the test must be free of bubbles.	
8	Open cap at fuel tank		

9	Test fuel pressure downstream of fuel filter	<p>Connect test and measuring equipment to low pressure fuel circuit</p> <p>Perform test</p> <p></p> <p></p> <p></p>	<p>Page 50</p> <p>Page 51</p> <p>123 589 04 21 18</p> <p>541 589 02 21 00</p> <p>541 589 00 91 00</p>
10	Measure fuel return flow quantity at the nozzle holder combinations	<p>Connect test and measuring equipment to low pressure fuel circuit</p> <p>Perform test</p> <p></p> <p></p> <p></p> <p></p> <p></p> <p> If the fuel return flow quantity is o.k., it is not necessary to carry out any further tests.</p>	<p>Page 52</p> <p>Page 53</p> <p>000 589 07 03 00</p> <p>000 589 68 03 00</p> <p>541 589 00 91 00</p> <p>BA07.15-N-1004-01A</p> <p>BA07.15-N-1006-01A</p>
11	Measure fuel return flow quantity at engine	<p>Connect test and measuring equipment to low pressure fuel circuit</p> <p>Perform test</p> <p></p> <p></p>	<p>Page 64</p> <p>Page 56</p> <p>541 589 00 91 00</p> <p>BA07.15-N-1007-01A</p>
12	Testing fuel inlet pressure upstream of fuel pump	<p>Connect test and measuring equipment to low pressure fuel circuit</p> <p>Perform test</p> <p></p> <p></p>	<p>Page 65</p> <p>Page 66</p> <p>617 589 04 21 00</p> <p>541 589 00 91 00</p>
13	Test low pressure fuel circuit in engine for leaks	<p>Connect test and measuring equipment to low pressure fuel circuit</p> <p>Perform test</p> <p></p> <p></p> <p></p>	<p>Page 66</p> <p>Page 67</p> <p>123 589 04 21 18</p> <p>541 589 02 21 00</p> <p>541 589 00 91 00</p>
14	Install in the reverse order		
15	Bleed fuel system		
16	Test vehicle performance on the chassis dynamometer	<p> Only after all the tests or measurements have been completed and any defects rectified: ↓</p> <p>If no improvement is achieved in fuel consumption or performance, then connect a fuel consumption measuring system.</p>	

Nm Diesel injection system with unit pumps (MR/PLD)

Number	Designation		Engine 904.9, 906.9
BA07.15-N-1004-01A	Injection line to pressure pipe connection of unit pump	Nm	25
BA07.15-N-1006-01A	Banjo bolt of fuel line to cylinder head	Nm	40
BA07.15-N-1007-01A	Banjo bolt of fuel line to overflow valve	Nm	40

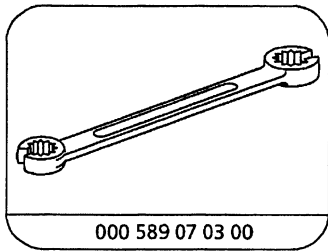

Ring wrench

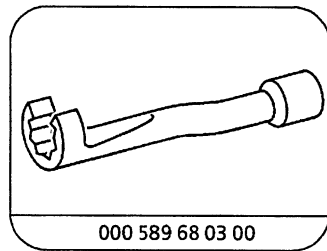

Ring wrench bit

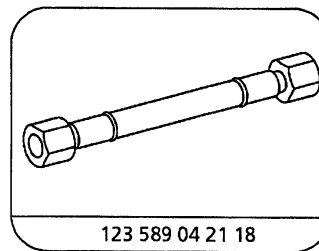

High-pressure hose

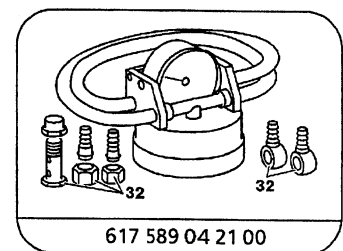

Tester

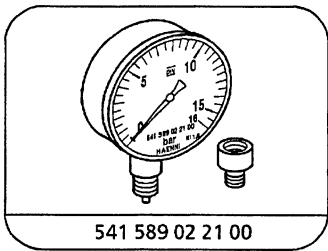

Tester

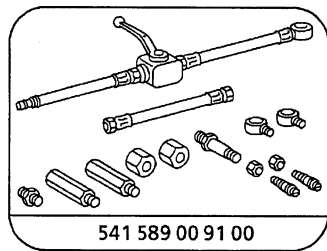

Adaption parts

AR07.15-W-2000-01K	Installing test/measuring equipment in low pressure fuel circuit		
--------------------	--	--	--

Nm Diesel injection system with unit pumps (MR/PLD)

Number	Designation		Engine 904.9, 906.9
BA07.15-N-1007-01A	Banjo bolt of fuel line to overflow valve	Nm	40

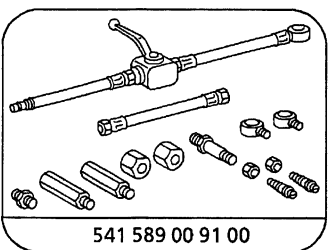

Adaption parts

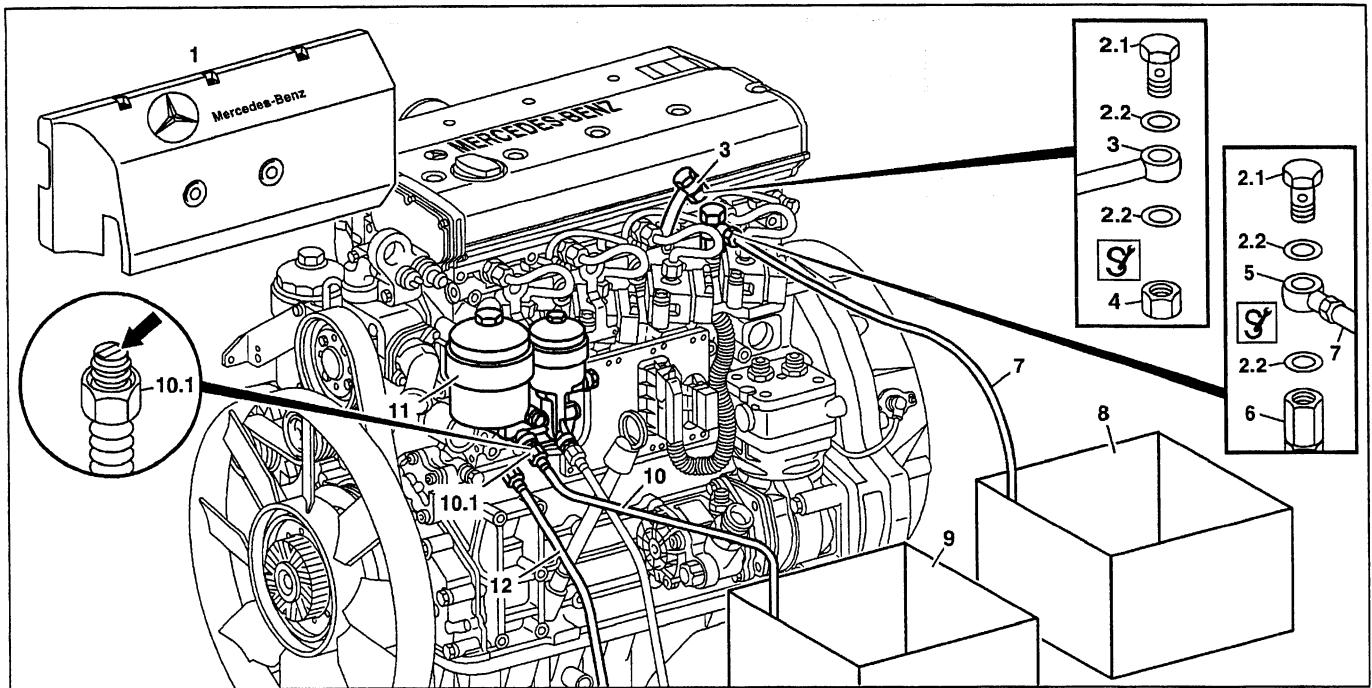

W07.15-1012-09

Shown on engine 904.909

- 1 Remove engine panel (1).
- 2 Separate fuel return flow line (3) at overflow valve (6).
 - ⓘ Counterhold overflow valve (6) when slackening the fuel return flow line (3).
- 3 Seal fuel return flow line (3) with banjo bolt (2.1) and ⓘ nut (4).
- 4 ⓘ Attach banjo union (5) to overflow valve (6).
 - ⓘ Counterhold overflow valve (6) when tightening.
- 5 Attach transparent fuel line (7) to ⓘ banjo union (5) and run into a clean vessel (8).
- 6 Separate fuel return flow line (12) at fuel filter housing (11) connection "RL" and attach transparent fuel line (10).
 - ⓘ The connection (10.1) with opening arm (arrow) must press the check valve in the connection open.
- 7 Run fuel return flow line (10) into a clean vessel (9).

AR07.15-W-2000-01J	Installing test/measuring equipment in low pressure fuel circuit		
--------------------	--	--	--

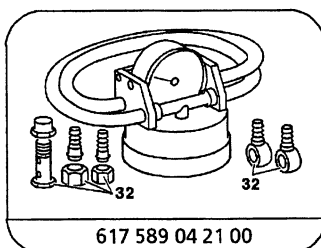

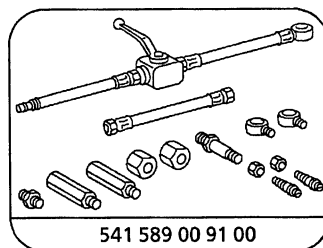

Tester



Adaption parts

Shown on engine 904.909

1  Install tester (2) together with test lines (2.1) and connection (2.3) between fuel feed line (3) and fuel prefilter housing (1).

  The connection (2.2) with opening arm (arrow) must press the check valve in connection (1.1) open.

 Inspect the seals at connection (2.2) for damage, replace if necessary.

2 Bleed fuel system.

3  Attach tester (2) to frame.

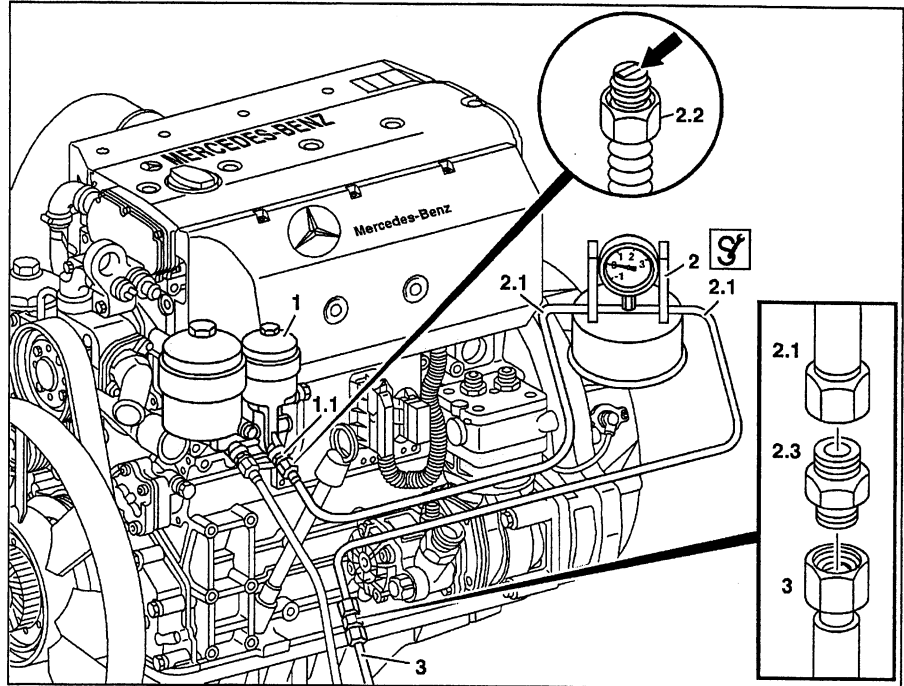

W07.15-1008-06

AD07.15-W-7001-03F	MR (PLD) test of hydraulic system fuel intake pressure upstream of fuel pump	Engine 904.904-908/921, as of end no. 040488 Engine 904.909-911/915- 917/922/923/941, 906.910/911/915/916/919-923/925- 928/939/940/941/942/943/951/952	
--------------------	--	---	--

⇒	Scope of test	Tester/test connection	Operation/ Requirement	Specified value	● Possible cause/ Remedy
1.0	Test fuel intake pressure upstream of fuel pump Attach test and measuring equipment to low pressure fuel circuit &(AR07.15-W-2000-01J)		Engine: start Idle speed 600 - 650 rpm: Governed speed 2500 rpm:	- 0.09 to - 0.12 bar - 0.4 to - 0.5 bar	● Fuel intake pressure too low (→ 0 bar) &(AD07.15-W-5001-01F) ● Fuel intake pressure too high (→ - 1 bar) &(AD07.15-W-5001-02F)

AR07.15-W-2000-01M	Installing test/measuring equipment in low pressure fuel circuit		
--------------------	--	--	--

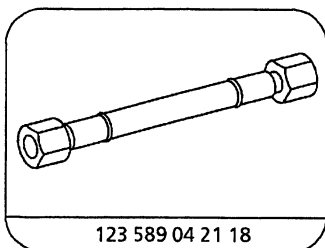

High-pressure hose

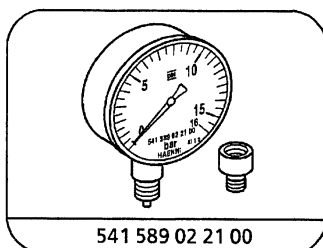

Tester

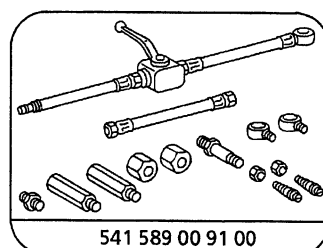

Adaption parts

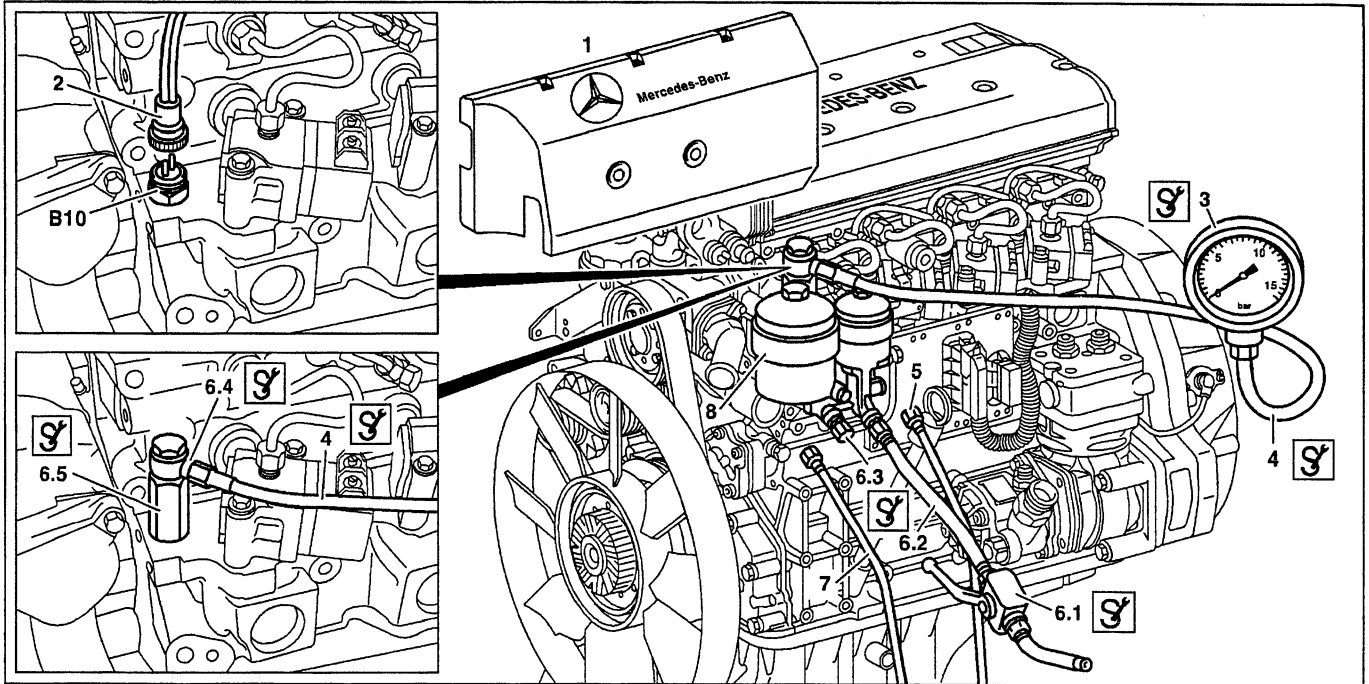

W07.15-1010-09

Shown on engine 904.909

- 1 If MPS or HPS shift fitted:
Unscrew bottom bolt at bracket of cylinder head.
- 2 Remove engine panel (1).
- 3 Remove fuel temperature sensor (B10).
- i** Installation: Bleed fuel system.
- 4 Install adapter piece (6.5) together with seal at crankcase.
- 5 Attach banjo union (6.4), test hose (4) and pressure gage (3) to adapter piece (6.5).
- 6 Disconnect fuel return flow line (7) at fuel filter housing (8) connection "RL" and seal with cap (6.3).
- 7 Disconnect fuel feed line (5) at fuel prefilter housing (8) connection "VL" and attach connection line (6.2) with shutoff cock (6.1).

AD07.15-W-7001-08F	MR (PLD) test of hydraulic system low pressure fuel circuit leaks	Engine 904.904-908/921, as of end no. 040488 Engine 904.909-911/915-917/922/923/941, 906.910/911/915/916/919-923/925-928/939/940/941/942/943/951/952	
--------------------	---	---	--

⇒	Scope of test	Tester/test connection	Operation/Requirement	Specified value	● Possible cause/Remedy
1.0	Test low pressure fuel circuit for leaks Attach test and measuring equipment to low pressure fuel circuit &(AR07.15-W-2000-01M)		Fill low pressure fuel circuit in the engine with compressed air Fuel circuit without PLD heat exchanger Test pressure 10 bar: Test time 5 minutes:	≤ 0.25 bar	● in the case of major pressure drop or fuel in engine oil &(AD07.15-W-5001-06F)

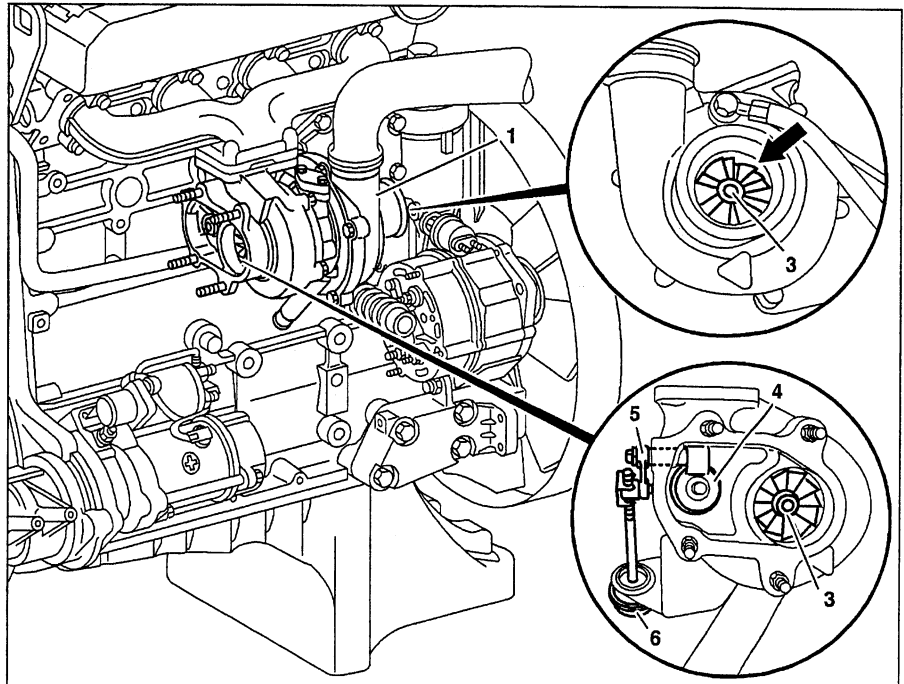

ENGINE 904.905 /906 /907 /909 /910 /911 /915 /916 /917 /921 /922, 906.910 /911 /915 /916 /919 /920 /921 /922 /923 /925 /926 /927 /928 /939 /940 /941 /942 /943 /951 /952

- 1 Turbocharger
- 3 Rotor shaft
- 4 Control flap
- 5 Control flap shaft
- 6 Control unit



W09.40-0012-06

	Inspecting		
1	Remove engine brake flap connection	Engine 904.905-907/909-911/915-917/ 921/922 Engine 906.910/911/915/916/919-923/ 925-928/939-943/951/952	AR14.15-W-6302A AR14.15-W-6302F
2	Remove air intake hose		
3	Inspect axial play and radial play at the rotor shaft (3)	<p>i If there is no sign of the rotor shaft touching the turbocharger housing on either side, the axial play and radial play are OK.</p> <p>If there is any sign of the rotor shaft touching the turbocharger housing: ↓</p> <p>Replace turbocharger.</p> <p>Engine 904.905-907/909-911/ 915-917/921/922 Engine 906.910/911/915/916/919-923/ 925-928/939-943/951/952 Engine 904.908/923</p>	<p style="text-align: right;">Page 69</p> <p style="text-align: right;">Page 71</p> <p>AR09.40-D-6020D</p>
4	Inspect control flap (4) and control flap shaft (5) for damage and play	<p>If wear present: ↓</p> <p>Replace turbocharger.</p> <p>Engine 904.905-907/909-911/ 915-917/921/922 Engine 906.910/911/915/916/919-923/ 925-928/939-943/951/952 Engine 904.908/923</p>	<p style="text-align: right;">Page 71</p> <p>AR09.40-D-6020D</p>

5	Inspect control unit (6)	<p>Engine 904.907/911/917, 906.911/921/923/926/928/941/952</p> <p> Without radiator connection</p> <p> If pressure drop exists: ↓</p> <p>Replace turbocharger.</p> <p>Engine 904.905-907/909-911/ 915-917/921/922</p> <p>Engine 906.910/911/915/916/919-923/ 925-928/939-943/951/952</p> <p>Engine 904.908/923</p>	<p>Page 70</p> <p>124 589 15 21 00</p> <p>Page 71</p> <p>Page 71</p> <p>AR09.40-D-6020D</p>
6	Install air intake hose		
N	Install engine brake flap connection		AR14.15-W-6302A

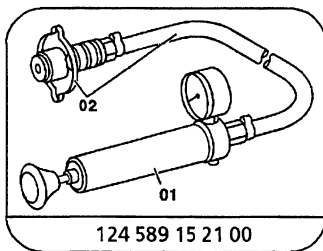

Tester

AR09.40-W-5910-01A	Inspecting axial play and radial play at rotor shaft		
--------------------	--	--	--

- 1 Rotate rotor shaft (1) at the shaft nut or at the turbine wheel and at the same time inspect that the rotor shaft runs freely and evenly. Move the rotor shaft back and forward until it is free of oil carbon deposits.



Rotor shaft is centrifugally stabilized and runs in its bearings with a relatively large play.

Inspecting axial play:

- 2.1 Move rotor shaft (1) in longitudinal direction and inspect whether any sign of the turbine wheel or compressor wheel touching is visible.



If there is no sign of the rotor shaft touching the turbocharger housing on either side, the axial play is o.k.

- 2.2 If any rubbing can be felt, replace the turbocharger.

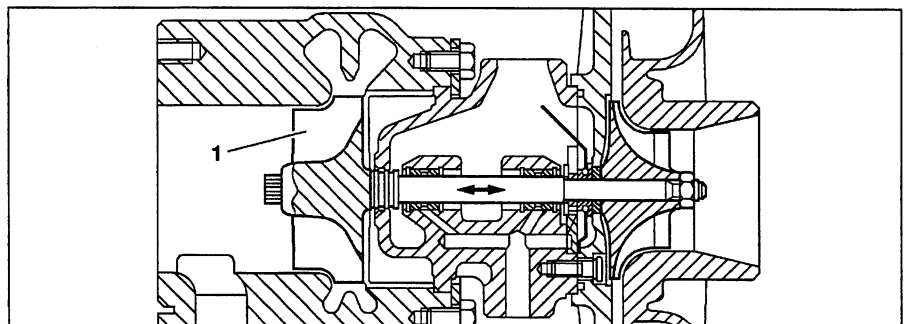

W09.40-0002-04

Inspecting radial play:

3.1 Deflect rotor shaft (1) in the radial direction and at the same time rotate and inspect whether there is any sign of the turbine wheel or compressor wheel touching.

i If there is no sign of the rotor shaft touching the turbocharger housing on either side, the radial play is o.k.

3.2 If any rubbing can be felt, replace the turbocharger.

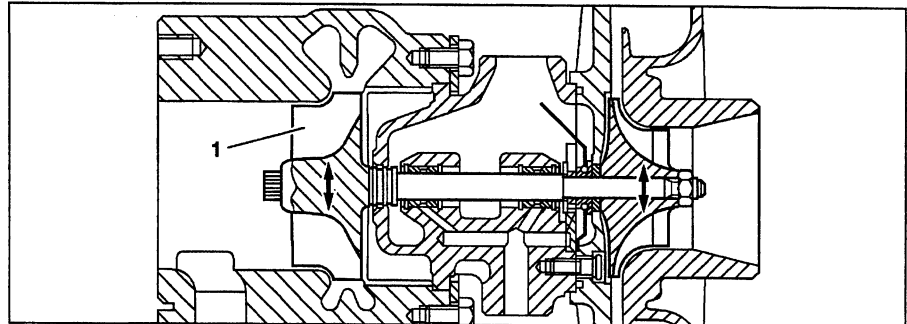

W09.40-0003-04

AR09.40-W-5910-02A	Testing control unit		
--------------------	----------------------	--	--

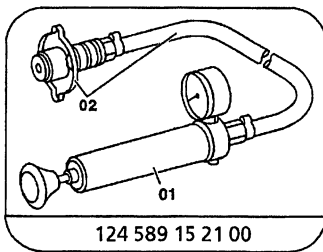

124 589 15 21 00

Tester

1 Inspect control unit (1) for external damage.

i If the control unit is misshapen, the turbocharger must be replaced.

2 **S** Fit hand pump (2) (without coolant connection) onto the hose connection (3) of the control unit (1) and pressurize with not more than 1 bar.

i If the diaphragm is damaged, the compressed air will escape between valve rod (arrows) and control unit mount. Replace turbocharger.

3 **S** Take off hand pump (2) and screw hose connection (3) tight.

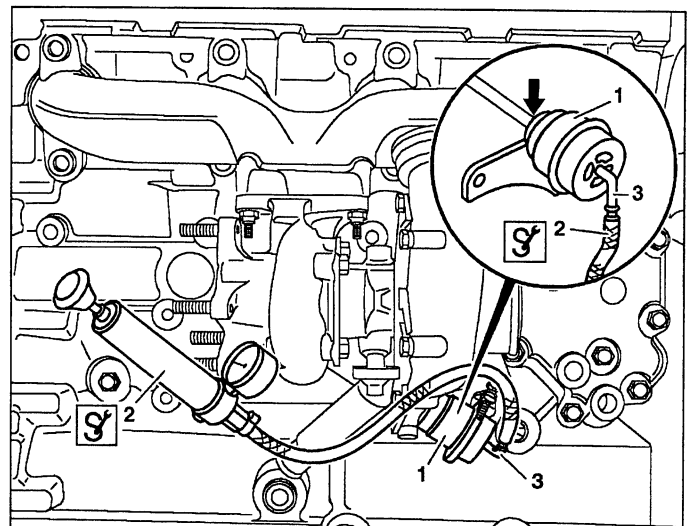

W09.40-0004-11





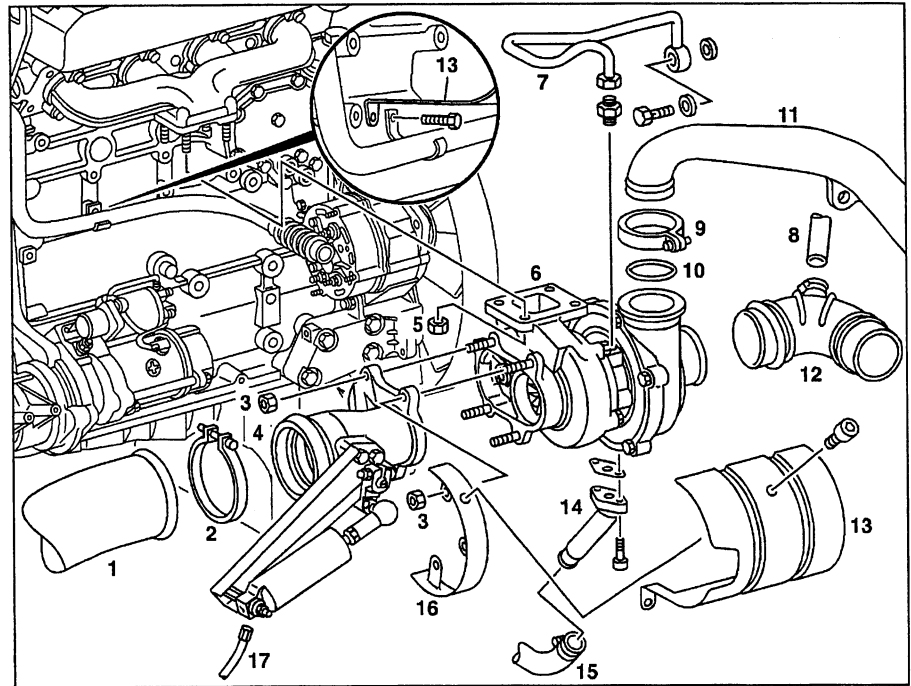









ENGINE 904.905 /906 /907 /909 /910 /911 /915 /916 /917 /921 /922, 906.910 /911 /915 /916 /919 /920 /921 /922 /923 /925 /926 /927 /928 /939 /940 /941 /942 /943 /951 /952

- 1 Exhaust pipe
- 2 Clamp
- 3 Nut
- 4 Engine brake flap connection
- 5 Nut
- 6 Turbocharger
- 7 Oil pressure line
- 8 Crankcase ventilation line
- 9 Clamp
- 10 Seal
- 11 Boost air pipe
- 12 Air intake hose
- 13 Heat shield
- 14 Oil return flow line
- 15 Oil return flow hose
- 16 Bracket
- 17 Compressed air line



W09.40-0013-06

☒ ☒	Removing, installing		
<p>⚠ Danger!</p> <p>☒ ☒</p> <p>1</p> <p>ⓘ</p>	<p>Risk of explosion from explosive gas. Risk of poisoning and caustic burns from swallowing battery electrolyte. Risk of injury from caustic burns to eyes and skin from battery electrolyte or from handling damaged lead acid batteries.</p> <p>Disconnect battery</p> <p>Notes on battery</p>	<p>No fire, sparks, naked flames or smoking. Wear acid-resistant gloves, protective clothing and eye protection. Pour battery electrolyte only into suitable and appropriately marked containers.</p> <p>All models</p>	<p>Page 73</p> <p>Page 75</p>
<p>⚠ Danger!</p> <p>2</p> <p>ⓘ</p>	<p>Risk of injury from hand being jammed and bruised when tilting cab</p> <p>Tilt cab into repair position</p> <p>Notes on tilting cab</p>	<p>No person must be within the tilting range of the cab when the cab is tilted. Always tilt cab as far as the end position and secure with safety prop.</p> <p>Models 375, 673-679, 950-954, 957, 970-976</p>	<p>Page 25</p> <p>Page 26</p>
<p>3</p>	<p>Remove noise encapsulation panels</p>	<p>i On right and at bottom</p>	
<p>4</p>	<p>Remove charge air pipe (11)</p>	<p>Engine 904.905- 907/921</p> <p>Engine 904.909-911/915-917/922</p> <p>Engine 906.910/911/915/916/919-923/ 925-928/ 939-943/951/952</p>	<p>Page 76</p> <p>Page 77</p>
<p>5</p>	<p>Detach air intake hose (12) at turbocharger (6)</p>		
<p>6</p>	<p>Detach exhaust pipe (1) at engine brake flap connection (4)</p>	<p>i Installation: Clean sealing surfaces</p>	
<p>N</p>	<p>Detach compressed air line (17) at engine brake cylinder</p>		

8	Take off heat shield (13) at turbocharger (6) and at crankcase	 Installation: Engine 904.905-907/921: fit on heat shield and compressor inlet line together at crankcase.	
9	Detach oil return flow hose (15) at turbocharger (6)	 Collect engine oil which flows out.	
10	Detach oil pressure line (7) at oil filter and at turbocharger (6)	 Seal hole at turbocharger and at crankcase.  Installation: Before fitting on the oil pressure line, fill the turbocharger bearing housing through the oil filler hole with engine oil. Rotate the turbocharger shaft by hand during this step so that the bearing points are provided with a film of oil. Replace seals. 	BA09.40-N-1002-01B
11	Detach oil return flow hose (14) at turbocharger (6)		BA09.40-N-1003-01B
12	Take off turbocharger (6) together with engine brake flap connection (4) at exhaust manifold	Seal holes at turbocharger with caps.  Installation: Replace nuts (5). 	BA09.40-N-1001-01B
13	Take off engine brake flap connection (14) together with bracket (16)	 Installation: Replace nuts (3). 	BA14.10-N-1002-01B
14	Install in the reverse order		
15.1	Inspect engine oil level with the dipstick	Engine 904.905- 907/921	WH0101.40
15.2	Inspect engine oil level at the electric gage		
	Request engine oil level in display	Model 950- 957	AP18.00-W-0101-07A
	Request engine oil level in display	Model 970- 976	AP18.00-W-0101-07C
 Danger!	Risk of accident from vehicle starting off by itself when engine running. Risk of injury from bruises and burns if you hold your hand into engine when it is started or when it is running.	Secure vehicle to prevent it moving off by itself. Wear closed and close-fitting work clothes. Do not grasp hot or rotating parts.	Page 30
16	Start engine and observe oil pressure gage at idle speed	 Start engine with starter for not more than 90 s. Wait about 2 minutes before repeating start operation. Do not rev up engine until oil pressure is indicated.  The oil pressure gage must indicate oil pressure after about 10 s.	BE18.00-N-1001-01C
17	Switch off engine and inspect for leaks		

Test data of engine oil pressure

Number	Designation	Engine 904.9, 906.9	
BE18.00-N-1001-01C	Engine oil pressure at	Idle speed	bar ≥ 0.5
		Maximum speed	bar ≥ 2.5

Nm Turbocharger

Number	Designation		Engine 904.9	Engine 906.9
BA09.40-N-1001-01B	Nut of turbocharger to exhaust manifold	Nm	30	50
BA09.40-N-1002-01B	Bolt of oil pressure line to turbocharger	M8 Nm	40	40
		M6 Nm	10	10
BA09.40-N-1003-01B	Bolt of oil return flow line to turbocharger	Nm	10	10

Nm Exhaust manifold

Number	Designation		Engine 904.9, 906.9
BA14.10-N-1002-01B	Nut of engine brake flap connection to turbocharger	M8 Nm	30
		M10 Nm	50

AS54.10-Z-0001-01A	Explosion hazard from explosive gas. Danger of poisoning and acid burns when battery acid is swallowed. Danger of acid burns to skin and eyes from battery acid or when handling damaged lead-acid batteries.	Flames, sparks, open light and smoking prohibited. Wear acid resistant gloves, clothing and goggles. Store battery acid only in suitable, appropriately marked containers.	 Danger!
--------------------	---	--	--

Possible dangers

Explosion hazard

A highly explosive gas mixture is generated when lead-acid batteries are charged

Poisoning hazard

When battery acid is taken orally toxic symptoms can occur such as headache, dizziness, stomach pain, paralysis of the respiratory system, unconsciousness, vomiting, acid burns and cramps. Battery acid vapor can burn eyes. Inhalation can result in burns to mucous membranes and respiratory paths. Lead in the body can damage blood, nerves and kidneys; moreover, lead compounds pose a hazard for the reproduction organs.

Injury hazard

Battery acid contains sulfuric acid, which can cause severe burns to skin and eyes. When handling damaged lead-acid batteries (removing from accident vehicle) increased care is necessary due to the sharp edges on the broken housing and direct contact with the lead plates.

Rules of behavior/protective measures

- Charge lead-acid batteries only in well ventilated rooms.
- Fire, sparks, open light and smoking prohibited.
- Do not lay tools or other conductive items on lead-acid batteries (danger of short circuiting).
- Disconnect and remove lead-acid batteries for charging.
- Always disconnect negative pole first; always connect positive pole first.
- Switch on charger only after connecting to poles; switch off before disconnecting.

- Keep lead-acid batteries and battery acid away from unauthorized persons.
- Store battery acid only in suitable, appropriately marked containers.
- Store lead-acid batteries only in upright position.
- Ensure that gassing line is properly connected.
- Check gassing line for kinks and proper passage.
- Observe instructions for applicable lead-acid battery and vehicle operating instructions.
- Wear acid protective clothing and protective goggles with side guard.

First-aid measures

Eye contact

- Rinse eyes immediately with large quantities of water.

Skin contact

- Remove affected clothing.
- Neutralize acid on skin or clothing immediately with acid neutralizer or soap solution and rinse with large quantities of water.

Inhalation of battery acid vapor

- Move affected person to fresh air

Swallowing battery acid

- Have person drink large quantities of water containing activated charcoal.

Generally medical services or a physician should be contacted after administering first aid.

Fire protection measures

Suitable extinguishing agents

- CO₂ and dry extinguishing agents.

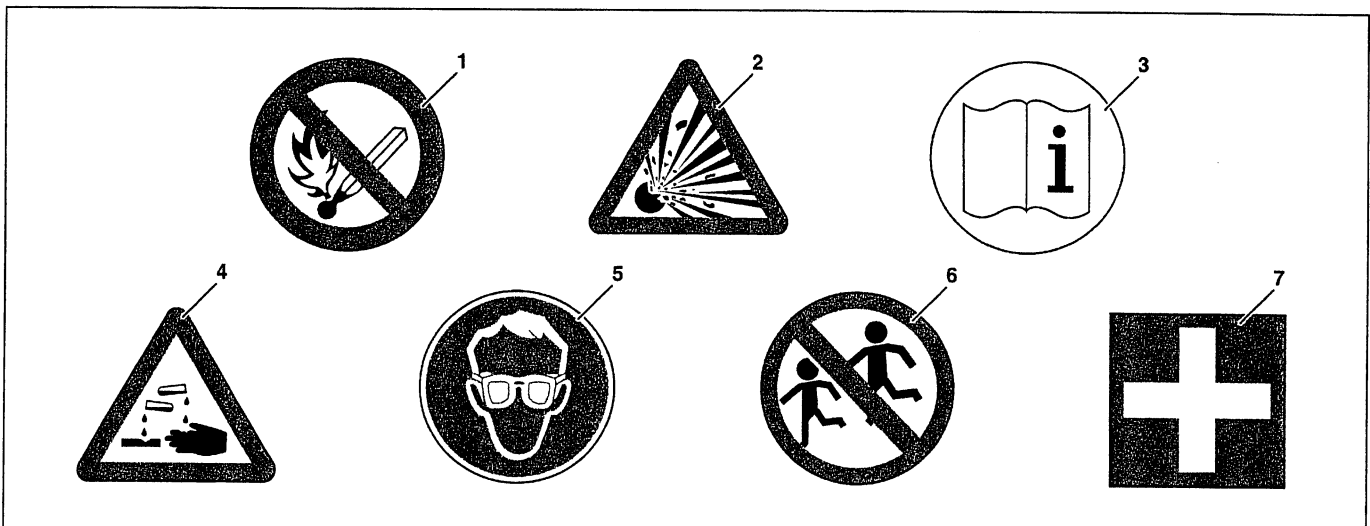

P54.10-0270-08

Warning notes on lead acid batteries

- | | | | | | |
|---|---|---|--------------------------------|---|-------------------------|
| 1 | Fire, sparks, open light and smoking prohibited | 3 | Observe operating instructions | 6 | Keep away from children |
| 2 | Explosion hazard | 4 | Danger of acid burns | 7 | First aid |
| | | 5 | Wear eye protection | | |

AH54.10-P-0001-01A	Notes on battery	All models	
--------------------	------------------	------------	---



- Do not store lead-acid batteries for extended periods of time in a place where they are exposed to direct sunlight.
 - Always store lead-acid batteries horizontally to prevent acid from escaping; do not tilt them when they are being transported.
 - Discharged or faulty lead-acid batteries can freeze up; therefore, ensure that they are stored at temperatures above freezing level.
 - Do not place any tools or other electrically conductive objects on a lead-acid battery (risk of short-circuit!).
 - Avoid mixing up positive and negative poles and avoid short-circuits.
 - Before removing or installing a lead-acid battery, switch off all electrical consumers where possible, and switch off the engine, so as to minimize the possibility of creating sparks.
 - Always **disconnect the negative pole first**; always **connect the positive pole first**.
-
- Do not switch on battery chargers until they have been connected to the battery poles; switch them off before disconnecting.
 - Only charge lead-acid batteries with direct current. For the charging current we recommend 10% of capacity for normal charging and 50% of capacity for rapid charging.
 - During rapid charging it must be insured that the casing of the lead-acid battery does not warm up excessively ($< 55\text{ }^{\circ}\text{C}$).
 - Lead-acid batteries should be kept clean and dry as far as possible.
 - It is advisable to grease the poles lightly with battery pole grease.
 - Lead-acid batteries should not be stored for extended periods without being recharged.
 - If a lead-acid battery is to remain in a vehicle which is not in use for an extended period, the negative terminal clamp should be disconnected.
-



ENGINE 904.905 /906 /907 /921

- 1 Boost air pipe
- 2 Bolt
- 3 Nut
- 4 Bolt
- 5 Flame starting system/solenoid valve
- 6 Boost air hose (red)
- 7 Nut
- 8 Flame glow plug
- 9 O-ring
- 10 Clip
- 11 Coolant pipe

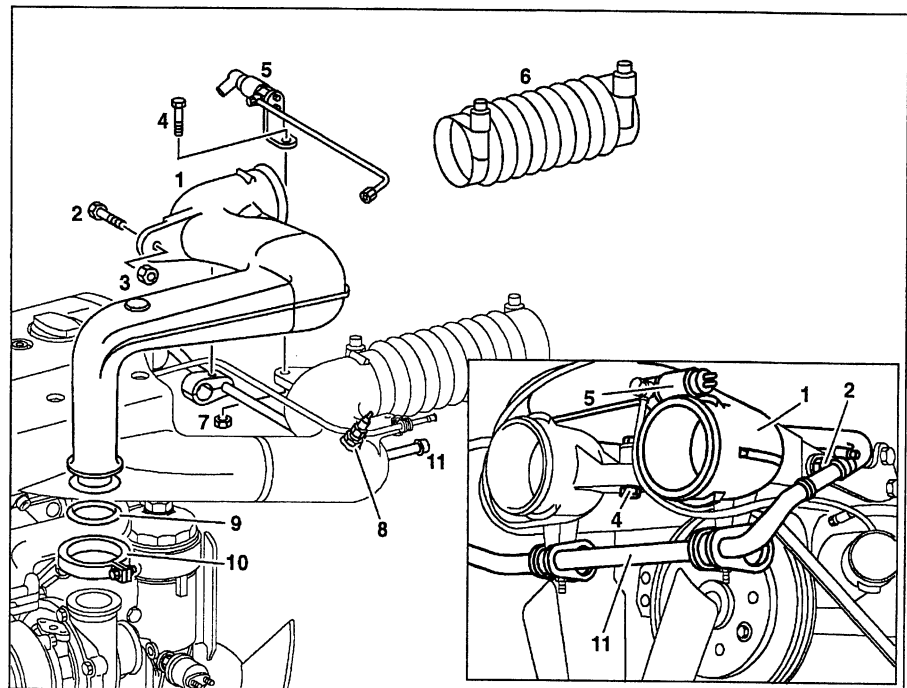

W09.41-0001-06

☒ ☒	Removing, installing		
⚠ Danger!	Risk of injury from bruises and jamming when tilting cap	No person should be in the tilting area of the cab when it is being tilted. Always tilt cab as far as the end position and secure with a safety prop.	Page 25
ⓘ	Notes re tilting cab Tilt cab		Page 26
2	Remove boost air hose (6)	Installation: boost air hoses must not be mixed up. ⓘ Red boost air hose is temperature-resistant and should always be installed between boost air pipe and intercooler.	
3	Take off boost air pipe (1)		
⚠ Danger!	Risk of explosion from ignition. Risk of poisoning from inhaling and swallowing fuel. Risk of injury as a result of fuel coming into contact with skin and eyes.	No fire, naked flame or smoking. Pour fuels only into suitable and appropriately marked containers. Wear protective clothing when handling fuel. ⓘ If flame starting system fitted collect fuel which flows out.	Page 29
4	Detach solenoid valve (5) together with bracket	ⓘ Do not remove coolant pipe.	
5	Disconnect coolant pipe (11) at boost air pipe (1)	ⓘ Seal holes at turbocharger. ⓘ Installation: replace O-ring (9)	
6	Remove boost air pipe (1)		
7	Install in the reverse order		

ENGINE 904.909 /910 /911 /915 /916 /917 /922, 906.910 /911 /915 /916 /919 /920 /921 /922 /923 /925 /926 /927 /928 /939
/940 /941 /942 /943 /951 /952

From turbocharger to charge air cooler

- 1 Charge air pipe (warm air)
- 2 Bolt
- 3 Bracket
- 4 O-ring
- 5 Clamp
- 6 Bolt
- 7 Nut
- 8 Charge air hose, red
- 9 Charge air pipe (cold air)

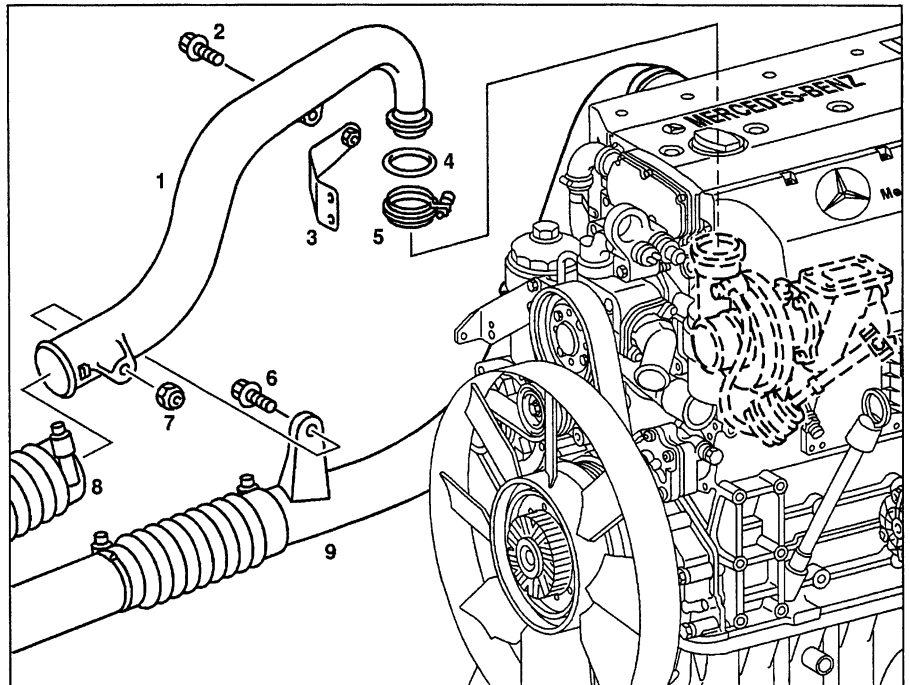

W09.41-0012-06

	Removing, installing		
Danger!	Risk of injury from hand being jammed and bruised when tilting cab	No person must be within the tilting range of the cab when the cab is tilted. Always tilt cab as far as the end position and secure with safety prop.	Page 25
1	Tilt cab		
	Notes on tilting cab	Models 375, 673-679, 950-954, 957, 970-976	Page 26
2	Remove noise encapsulation on right		
3	Remove red charge air hose (8)	Installation: Charge air hoses must not be mixed up. The red charge air hose is temperature-resistant and must always be installed between charge air pipe and charge air cooler.	
4	Remove charge air pipe (warm air) (1)	Seal holes at turbocharger. Installation: Replace O-ring (4).	BA09.41-N-1005-01B
5	Install in the reverse order		

Nm Charge air pipe/charge air cooler

Number	Designation	Engine 904.909/910/ 911/915/916/917/922/ 927/928, 906.910/911/915/916/ 919/920/921/922/923/ 925/926/927/928/935/ 939/955
BA09.41-N-1005-01B	Nut of charge air pipe to charge air pipe	Nm 30

ENGINE 904.909 /910 /911 /915 /916 /917 /922, 906.910 /911 /915 /916 /919 /920 /921 /922 /923 /925 /926 /927 /928 /939 /942 /943

From charge air cooler to charge air manifold

- 1 Charge air hose, black
- 2 Charge air pipe (cold air)
- 3 Bolt
- 4 Bolt
- 5 Wiring harness
- 6 Fuel line
- 7 Flame glow plug
- 8 Clamp
- 9 Charge air pipe (warm air)
- 10 Nut

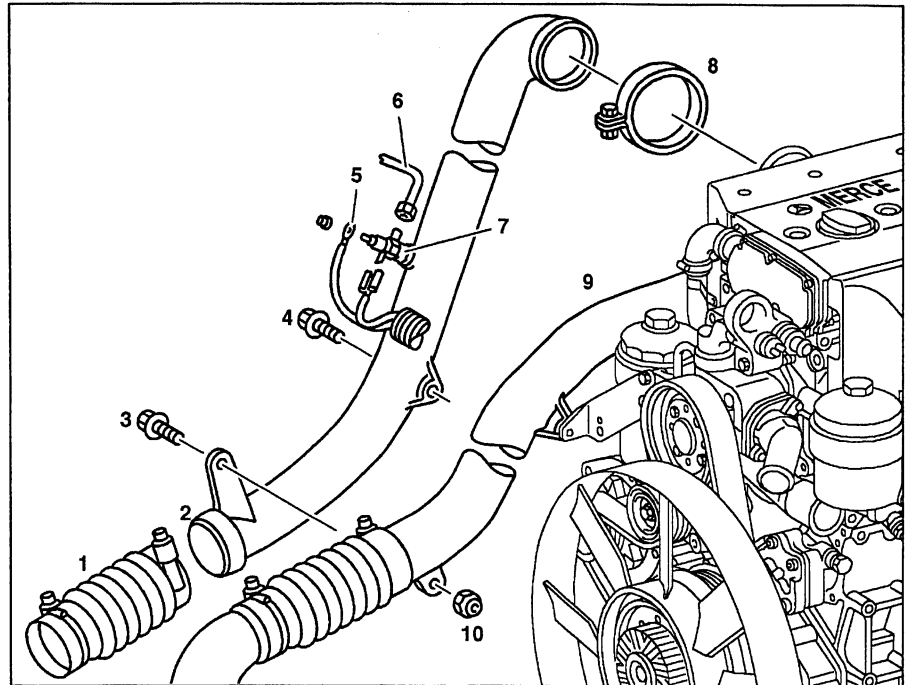

W09.41-0013-06

☒ ☒	Removing, installing		
<p>⚠ Danger!</p> <p>1</p> <p>ⓘ</p>	<p>Risk of injury from hand being jammed and bruised when tilting cab</p> <p>Tilt cab</p> <p>Notes on tilting cab</p>	<p>No person must be within the tilting range of the cab when the cab is tilted. Always tilt cab as far as the end position and secure with safety prop.</p> <p>Models 375, 673-679, 950-954, 957, 970-976</p>	<p>Page 25</p> <p>Page 26</p>
2	Remove noise encapsulation on right		
3	Remove black charge air hose (1)	<p>i Installation: Charge air hoses must not be mixed up.</p> <p>ⓘ The red charge air hose is temperature-resistant and must always be installed between charge air pipe and charge air cooler.</p>	
<p>⚠ Danger!</p> <p>4</p>	<p>Risk of explosion from ignition, risk of poisoning from inhaling and swallowing fuel, as well as risk of injury from skin and eye contact with fuel.</p> <p>Detach wiring harness (5) at fuel line (6) at the flame glow plug (7)</p>	<p>No fire, sparks, naked flames or smoking. Pour fuels only into suitable and appropriately marked containers. Wear protective clothing when handling fuel.</p> <p>If flame starting system (code M89) fitted</p> <p>i Collect fuel which flows out.</p>	<p>Page 29</p>
5	Remove charge air pipe (2)	<p>Nm</p> <p>Nm</p> <p>i Clean sealing surface at charge air manifold.</p>	<p>BA09.41-N-1004-01B</p> <p>BA09.41-N-1005-01B</p>
6	Install in the reverse order		

Nm Charge air pipe/charge air cooler

Number	Designation	Engine 904.909/910/ 911/915/916/917/922/ 927/928, 906.910/911/915/916/ 919/920/921/922/923/ 925/926/927/928/935/ 939/955
BA09.41-N-1004-01B	Bolt of charge pipe to charge to generator support	Nm 30
BA09.41-N-1005-01B	Nut of charge air pipe to charge air pipe	Nm 30

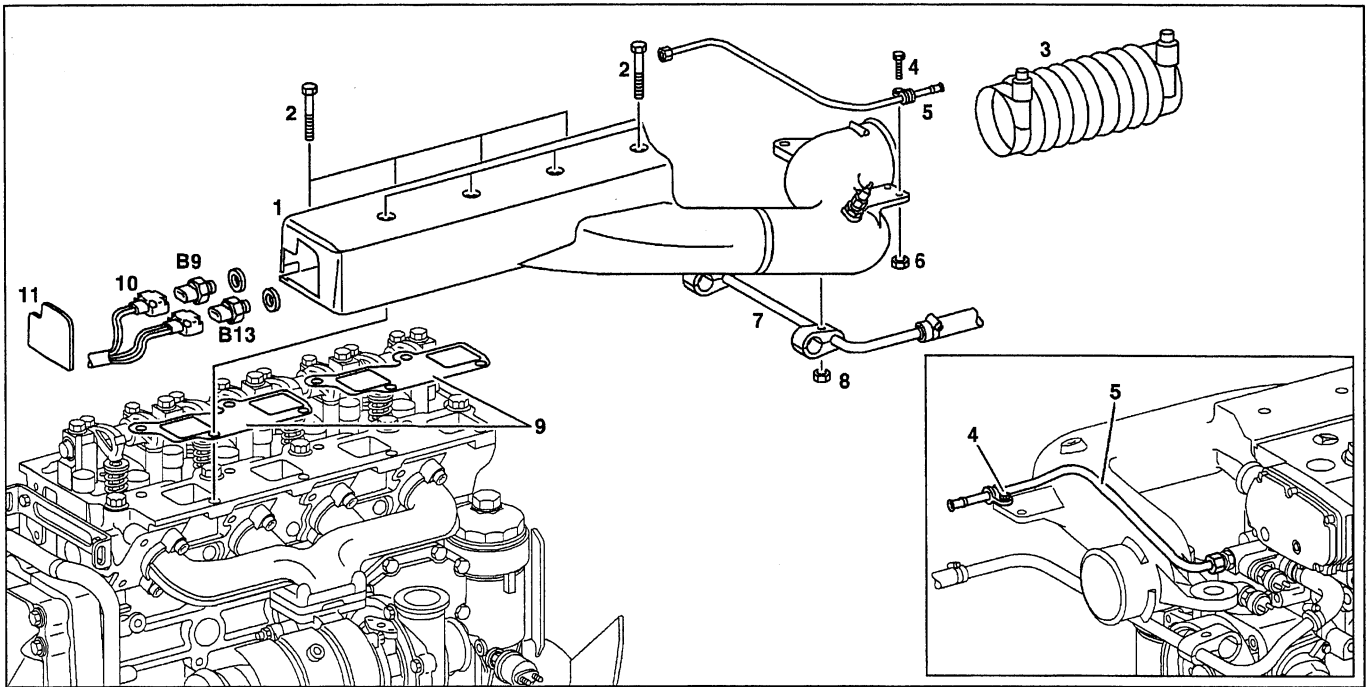

ENGINE 904.905 /906 /907 /921



W09.41-0015-09

- | | | | |
|---|--------------------|-----|------------------------------|
| 1 | Boost air manifold | 8 | Nut |
| 2 | Screw | 9 | Gasket |
| 3 | Boost air hose | 10 | Engine wiring harness |
| 4 | Screw | 11 | Cover |
| 5 | Coolant line/vent | | |
| 6 | Nut | B9 | Boost air temperature sensor |
| 7 | Coolant line | B13 | Boost pressure sensor |

	Removal, installation		
1	Remove cylinder head cover		AR01.20-W-5014A
2	Remove boost air line		Page 76
3	Remove boost air hose (3)	<p>i Installation: boost air hoses must not be mixed up.</p> <p>! Red boost air hose is temperature-resistant and should be installed between boost air line and intercooler</p>	
⚠ Danger!	Danger of severe burns to skin and eyes from hot coolant spewing out. Coolant is toxic when swallowed	Open cooling system only when coolant temperature is below 90 °C. Open cover slowly and reduce pressure. Do not fill beverage containers with coolant. Wear protective gloves, protective clothing and protective goggles.	Page 82
4	Drain coolant	Collect coolant.	WH2080
5	Disconnect coolant line/vent (5) at connector		
6	Detach coolant line (5,7) at boost air manifold (1)		
7	Disconnect coolant line (11) at boost air manifold (1)		

8	Release and separate engine wiring harness (10) at boost air temperature sensor (B9) and boost pressure sensor (B13)		
9	Take off boost air manifold (1)	Clean sealing surfaces.  Installation: replace gaskets (9). Pay attention to installation position.  Bolt for charge air manifold on cylinder head	BA09.41-N-1001-01B
10	Remove boost air temperature sensor (B9) and boost pressure sensor (B13)	 Installation: Replace sealing rings.	
11	Reinstall in opposite order		

 **Boost air line/intercooler**

Number	Designation	Engines 904.905/ 906/907/921
BA09.41-N-1001-01B	Bolt of boost air manifold to cylinder head	Nm 25

AS20.00-Z-0001-01A	Risk of injury to skin and eyes from scalding from hot coolant which splashes out..Risk of poisoning from swallowing coolant.	Do not open the cooling system unless the coolant temperature is below 90 °C. Open cap slowly and allow the pressure to release. Do not pour coolant into containers for drinks. Wear protective gloves, protective clothes, and eye protection.	 Danger!
--------------------	---	--	--

Possible dangers

Risk of injury

The cooling system is pressurized when the engine is warm. Risk of scalding from hot coolant which splashes out if the cooling system is opened suddenly.

Risk of poisoning

If coolant is swallowed, the person affected is likely to show signs of poisoning such as headaches, giddiness and stomach aches, paralysis of the respiratory system, unconsciousness, nausea, and convulsions.

Protective measures/rules of conduct

- Allow cooling system to cool down to a coolant temperature of less than 90 °C.
- Open coolant system cap slowly; open a conventional type of coolant system cap to the first detent and open a screw-type coolant system cap about 1/2 turn, and allow the pressure to release.
- Wear protective gloves, protective clothes, and eye protection.
- Do not pour coolant into containers for drinks.

First aid measures

- Pour large quantities of cold water over the affected area of skin and cover over with sterile bandages.
- Have person affected drink plenty of water to which medicinal carbon has been added.
- Consult a doctor if the person affected has severe burns or has swallowed considerable quantities.

ENGINE 904.909 /910 /911 /915 /916 /917 /922, 906.910 /911 /915 /916 /919 /920 /921 /922 /923 /925 /926 /927 /928 /939 /940 /941 /942 /943 /951 /952

- 1 Engine wiring harness
- 2 Cover
- 3 Bolt
- 4 Charge air manifold
- 5 Clamp
- 6 Boost air pipe
- 7 Gasket

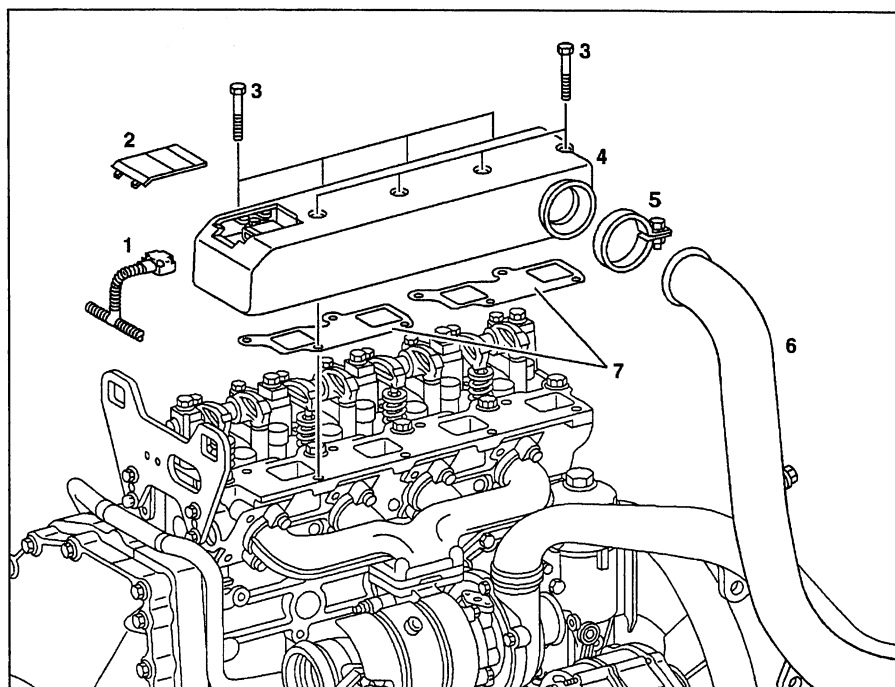

W09.41-0016-06

	Removing, installing		
1	Remove cylinder head cover		AR01.20-W-5014A
2	Remove charge air pipe (6) at charge air manifold (4)		Page 79
3	Take off cover (2) at charge air manifold (4)		
4	Release and disconnect engine wiring harness (1) at charge air combination sensor		
5	Detach charge air manifold (4) at cylinder head	Installation: Clean sealing surfaces Replace gaskets (7), pay attention to installation position. 	BA09.41-N-1001-01B
6	Remove charge air combination sensor		Page 84
N	Install in the reverse order		

Charge air pipe/charge air cooler

Number	Designation	Engine 904.909/910/ 911/915/916/917/922/ 927/928, 906.910/911/915/916/ 919/920/921/922/923/ 925/926/927/928/935/ 939/955
BA09.41-N-1001-01B	Bolt of charge air manifold to cylinder head	Nm 25

AR09.41-W-2003A	Removing, installing boost pressure, boost air temperature sensor	4.8.97
-----------------	---	--------

ENGINE 904.905 /906 /907 /921 /908 ## as of 040488,
 904.909 /910 /911 /915 /916 /917 /922 /923, 906.910 /911 /915 /916 /919 /920 /921 /922 /923 /925 /926 /927 /928
 /939 /942 /943

- 1 Cap
- 2 Connector of engine wiring harness
- 3 Charge air combination sensor (temperature, pressure)
- 4 Bolt

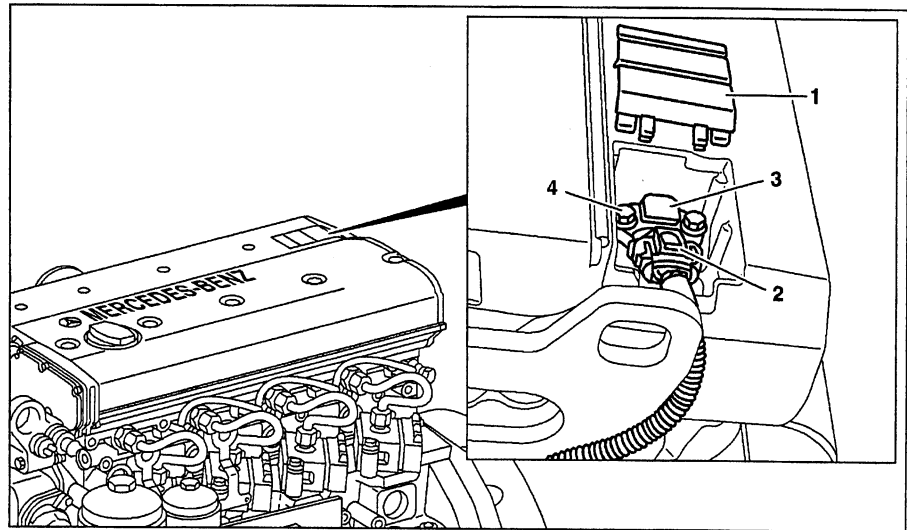

W09.41-0017-05

Modification notes



7.7.98	Tightening torque, bolt of charge air combination sensor to charge air manifold added.	Step 4	
--------	--	--------	--

	Removing, installing		
Danger!	Risk of injury from hand being jammed and bruised when tilting cab	No person must be within the tilting range of the cab when the cab is tilted. Always tilt cab as far as the end position and secure with safety prop.	Page 25
1.1	Tilt cab		
	Notes on tilting cab	Models 375, 673- 679, 950- 954, 957, 970- 976	Page 26
1.2	Remove service cover	Models 668, 670	
2	Remove cap (1) at charge air manifold		
3	Separate connector of engine wiring harness (2) at charge air combination sensor (3)		
4	Remove charge air combination sensor (3)		BA09.41-N-1008-01B
5	Install in the reverse order		

Charge air pipe/charge air cooler







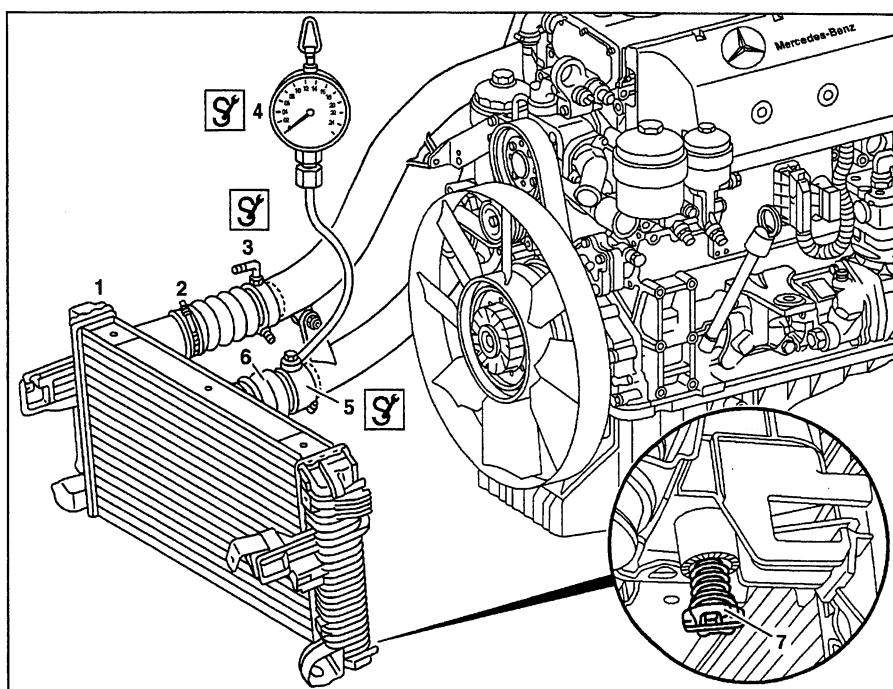

Number	Designation	Engine 904.905/ 906/907/921	Engine 904.908/ 923	Engine 904.909/910/ 911/915/916/917/922/ 927/928, 906.910/911/915/916/ 919/920/921/922/923/ 925/926/927/928/935/ 939/955
BA09.41-N-1008-01B	Bolt of charge air pressure/charge air temperature combination sensor	Nm 10	10	10



ENGINE 904.909 /910 /911 /915 /916 /917 /922, 906.910 /911 /915 /916 /919 /920 /921 /922 /923 /925 /926 /927 /928 /939 /942 /943

- 1 Charge air cooler
- 2 Charge air hose (red)
- 3  Test flange with compressed air connection
- 4  Tester with indicator
- 5  Test flange
- 6 Charge air hose (black)
- 7 Screw plug



W09.41-0014-06

	Removing, installing		
 Danger!	Risk of injury from hand being jammed and bruised when tilting cab	No person must be within the tilting range of the cab when the cab is tilted. Always tilt cab as far as the end position and secure with safety prop.	Page 25
	Notes on tilting cab	Models 375, 950-954, 970-976	Page 26
1	Tilt cab		
2	Remove noise encapsulation on right and at bottom		
3	Remove screw plug (7) at charge air cooler (1) and drain any oil which may have collected	 Collect escaping oil.	
4	Detach charge air hoses (2, 6) at both charge air pipes		
	Inspecting		
5	Fit test flanges (3, 5) onto the charge air hoses (2, 6)	 Inspect clamps for wear. Test flanges must be supported additionally at the openings of the two charge air pipes. 	904 589 07 63 00
6	Fit tester (4) onto test flange (5)		442 589 01 21 00
N	Fill charge air cooler (1) and charge air hoses (2, 6) at test flange (5) with compressed air	 Test pressure 1.5 bar	

8	Observe indication on tester to determine whether pressure drops	 If pressure drops, inspect charge air cooler (1), screw plug (7) and charge air hoses (2, 6) for damage, replace if necessary.	
9	Take off tester (4) and test flanges (3, 5)	 Release pressure	
10	Install in the reverse order		

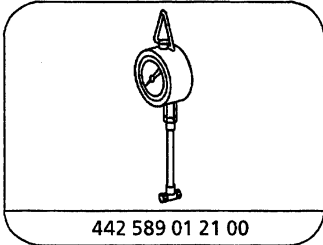

Tester

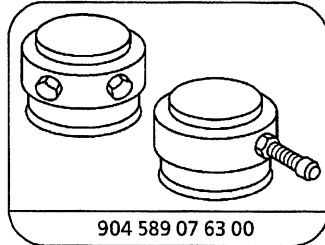

Test flange

ENGINE 904.905 /906 /907 /909 /910 /911 /915 /916 /917 /921 /922, 906.910 /911 /915 /916 /919 /920 /921 /922 /923 /925 /926 /927 /928 /939 /942 /943

- 1 Tensioning device with tensioning pulley
- 2 Tommy bar with wrench socket
- 3 Poly V-belt

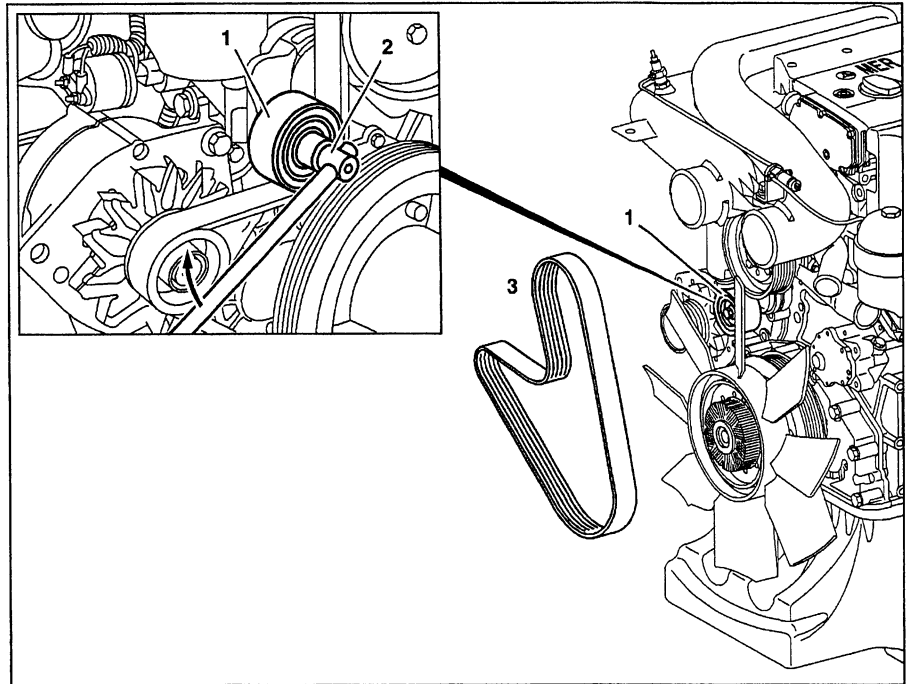

W13.22-0004-06

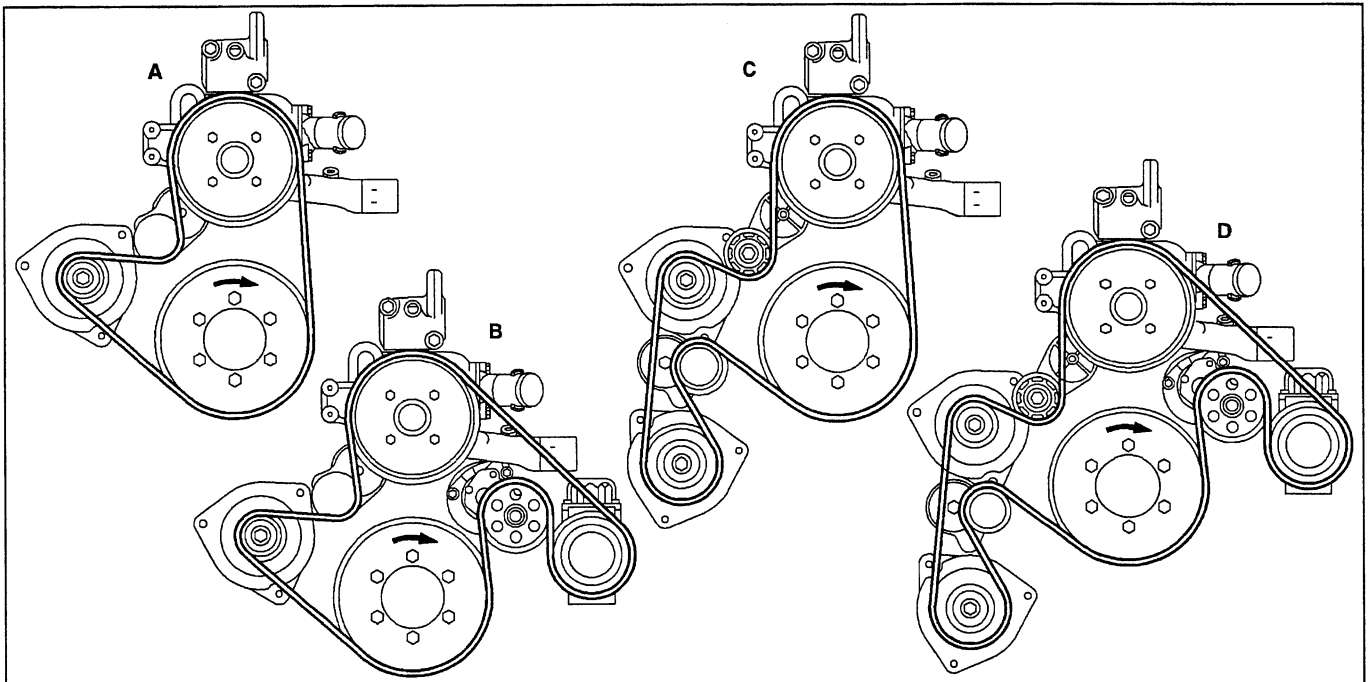

W13.22-0005-09

Poly V-belt running diagrams

A Standard









B With AC compressor

C With additional generator

D With AC compressor and additional generator



Removing

 Danger!	Risk of injury from hand being jammed and bruised when tilting cab	No person must be within the tilting range of the cab when the cab is tilted. Always tilt cab as far as the end position and secure with safety prop.	Page 25
	Notes on tilting cab	Models 375, 673-679, 950-954, 970-976	Page 26
1	Tilt cab		
2	Remove noise encapsulation on side and at bottom		
3	Use tommy bar and wrench socket (2) to swivel tensioning pulley (1) up and hold	 Swivel tensioning pulley up only at the bolt (against the spring tension).	
4	Take off poly V-belt (3)	 Do not kink poly V-belt when removing.	
5  AP	Inspect condition of poly V-belt Damage patterns for poly V-belts		AP13.22-D-1351-01A
6	Swivel back tensioning pulley		
N	Inspect vibration damper, belt pulleys of generator and of coolant pump as well as tensioning device and tensioning pulley (1)	Replace any parts which are damaged or worn: ↓ Vibration damper Tensioning device with tensioning pulley Belt pulley of coolant pump	AR03.30-W-1600A Page 89 AR20.10-W-1271A
	Installing		
8	Fit poly V-belt (3) onto the belt pulleys and onto the vibration damper	 Do not fit poly V-belt onto tensioning pulley (1) at this stage.	
9	Swivel tensioning pulley (1) up and fit poly V-belt (3) onto the tensioning pulley	 Swivel tensioning pulley up only at the bolt.  Ensure the poly V-belt is correctly fitted on the belt pulleys.	
10	Install noise encapsulation panels on side and at bottom		
11	Tilt cab back to driving position		



ENGINE 904.905 /906 /907 /909 /910 /911 /915 /916 /917 /921 /922, 906.910 /911 /915 /916 /919 /920 /921 /922 /923 /925 /926 /927 /928 /939 /942 /943

ENGINE 904.908 /923 in MODEL 668, 670

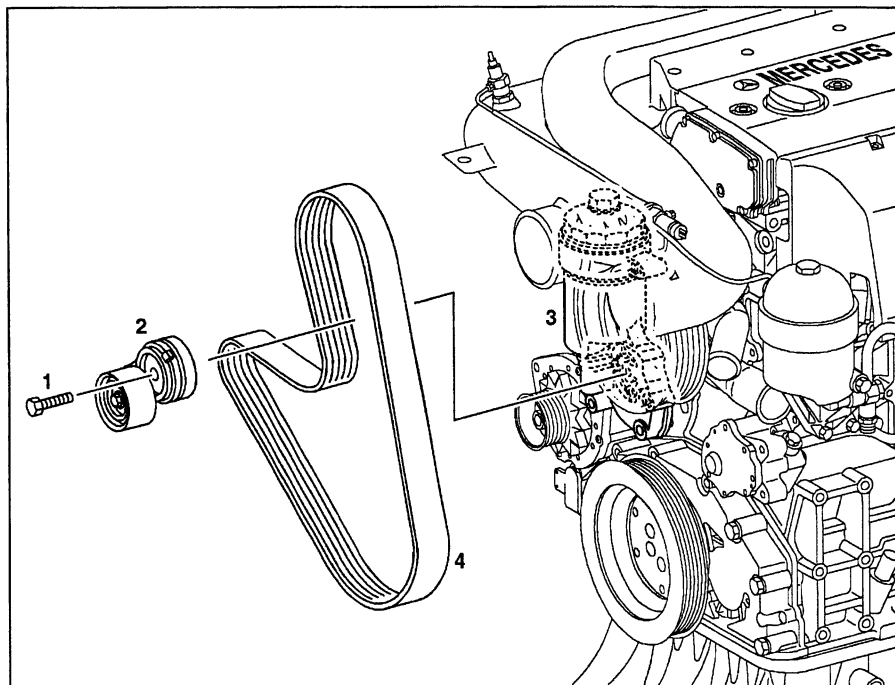
- 1 Bolt
- 2 Tensioning device with tensioning pulley
- 3 Oil filter housing
- 4 Poly V-belt



W13.25-0001-06

	Removing, installing		
1	Remove poly V-belt (4)	Engine 904.905-907/909-911/915-917/ 921/922 Engine 906.910/911/915/916/919-923/ 925-928/939/942/943 Engine 904.908/923	Page 87 AR13.22-D-1202D
2	Take off tensioning device (2) at oil filter housing (3)	 Installation: Fix pins at tensioning device into the holes at the oil filter housing (3). 	BA13.25-N-1001-01C
3	Install in the reverse order		

 Belt tensioning device

Number	Designation	Engine 904.9, 906.9
BA13.25-N-1001-01C	Bolt of poly V-belt tensioning device to crankcase	Nm 50



ENGINES 904.905 /906 /907 /908 /909 /910 /911 /915 /916 /917 /921 /922 /923, 906.910 /911 /915 /916 /919 /920 /921 /922 /923 /925 /926 /927 /928 /939 /942 /943
with single-cylinder compressor

- 1 Compressor
- 3 Coolant line (return)
- 4 Connection
- 5 Compressed air line
- 6 Suction line
- 7 Connection
- 8 Coolant line (feed)
- 9 O-ring
- 10 Drive gear
- 11 Nut
- 12 Allen screw
- 13 Cross plate
- 14 Power steering pump
- 15 Bracket
- 16 Steering line (pressure)
- 17 Steering line (suction)

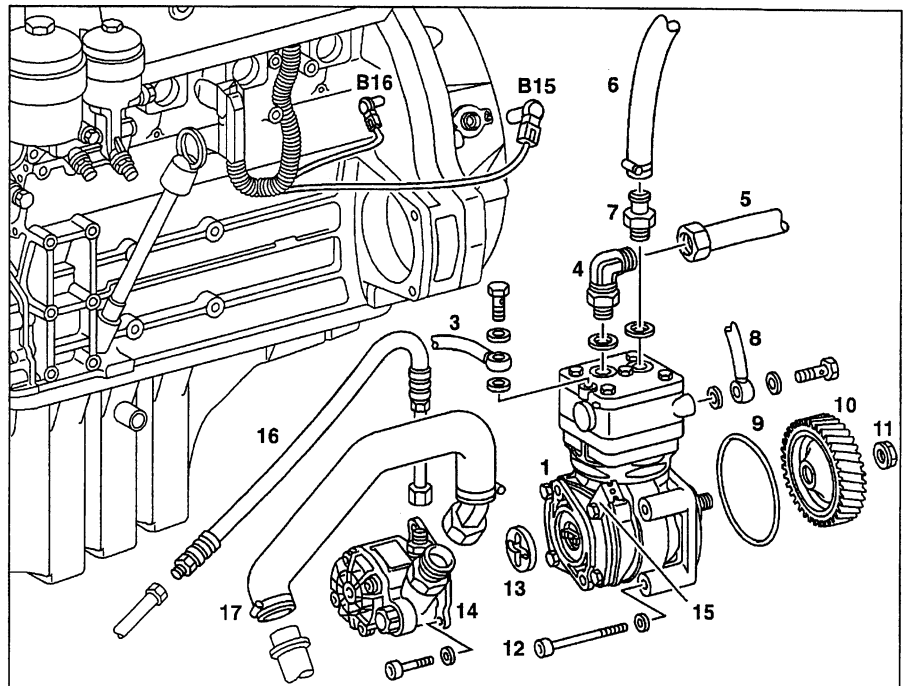
- B15 Crankshaft position sensor
- B16 Camshaft TDC sensor, cylinder 1



W13.30-1012-06

- 1 Compressor
- 9 O-ring
- 10 Drive gear
- 11 Nut
- 13 Cross plate
- 18  Blocking device
- 18a Nut
- 19  Puller

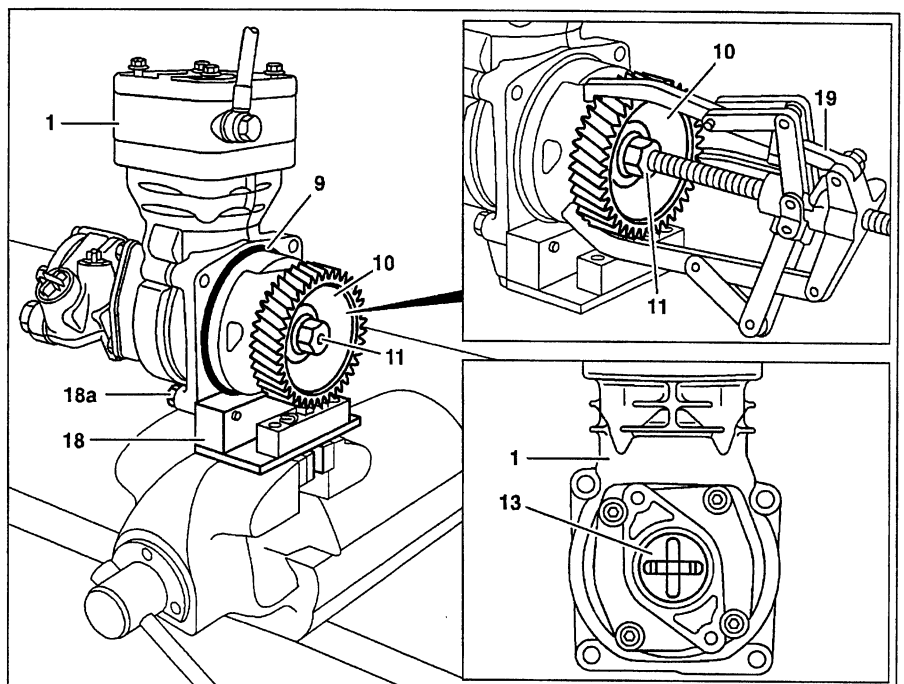











W13.30-0039-06



















Modification notes

30.11.99	Procedure modified	Stages 3.3, 4.3, 5, 6, 10, 11 and 13	
10.4.00	Value changed from 57 Nm to 60 Nm	Value changed in BA26.60-N-1009-01D on transmission 715.060 with code GS3	BA26.60-N-1009-01D



Removing, installing

1.1 	Tilt cab Notes on tilting cab	Models 375, 673-679, 950-954, 970-976	Page 26
1.2	Remove service cover	Models 668, 670	
2	Remove left and bottom sections of noise encapsulation		
3.1	Detach gearshift linkage from gearshift lever or from transmission	Engines 904.905-907/909-911/ 915-917/921/922	
3.2	Detach gearshift lever with gearshift linkage from engine	Engines 906.910/911/915/916/919/939	
4	Detach hydraulic lines from engine and transmission as well as hydraulic gear and gate shift cylinders at transmission	Engines 906.920-923/925-928 with hydro-pneumatic gearshift mechanism (HPS):  Do not separate hydraulic lines, place gear and gate shift cylinders to the side with hydraulic lines connected.  Gear hydraulic cylinder to gearshift shaft  Bearing bracket to transmission housing  Gate hydraulic cylinder to transmission housing  Gate hydraulic cylinder to shift shaft  Gear hydraulic cylinder to transmission housing.  Compressed-air line to control valve/gearshift cylinder	Page 94 BA26.60-N-1009-01D BA26.60-N-1010-01D BA26.60-N-1011-01D BA26.60-N-1012-01D BA26.60-N-1024-01D BA26.60-N-1005-01F
5	Remove MR/PLD control unit	Engines 904.905-907/909-911/ 915-917/921/922 Engine 904.908/923	Page 24 AR07.15-D-1628D
6	Disconnect engine wiring harness on engine brake solenoid	Engines 906.910/911/915/916/ 919-923/925-928/939/942/943	
7	Detach crankshaft position sensor (B15) at timing case	 Installation: Press in camshaft TDC sensor, cylinder 1, crankshaft position sensor and clamping piece as far as stop.	
 Danger!	Risk of injury to skin and eyes from scalding with hot coolant which splashes out. Risk of poisoning from swallowing coolant.	Do not open cooling system unless coolant temperature is below 90 °C. Open cap slowly and release the pressure. Do not pour coolant into beverage bottles. Wear protective gloves, protective clothing and eye protection.	Page 82
8  	Drain coolant and collect	Engine 904.905-907/921 Engines 904.909-911/915-917/922 Engines 906.910/911/915/916/ 919-923/925-928/939/942/943 Engine 904.908/923	WH2080 AP20.00-W-2080A AP20.00-D-2080A
9	Detach coolant lines (3, 8) on compressor cylinder head (1)	 Installation: Replace seals. 	BA13.30-N-1004-01A

10	Unscrew compressed-air line (5) on compressor (1) and inspect for carbon deposits	 If carbon deposits are present, the compressed-air line between compressor and compressed-air drier and the four-circuit protection valve must additionally be inspected. Replace parts with carbon deposits.  Installation: Inspect compressed air line for leaks. 	BA13.30-N-1007-01A
11	Detach suction line (6) on compressor (1)		BA13.30-N-1008-01A
 Danger! 12  AP  AP	Risk of injury to skin or eyes from hydraulic fluid spraying out under pressure. Risk of poisoning from swallowing hydraulic fluid. Separate both steering lines (16,17) at parting point	Render the hydraulic system pressureless before commencing work on system. Wear protective clothing and eye protection. Counterhold connections on power steering pump when loosening, collect escaping hydraulic fluid.  Installation: Top up hydraulic fluid and bleed steering. Engines 904.905-907/921 Engines 904.908/923 Engines 904.909-911/915-917/922 Engines 906.910/911/915/916/ 919-923/925-928/939/942/943	Page 95 WH4611 AP46.00-D-4611A AP46.00-W-4611A
13	Detach compressor (1) together with power steering pump (14) at crankcase	Collect escaping engine oil.  Installation: First fasten Allen screw (12), then fasten remaining Allen screws. 	BA13.30-N-1006-01A
14	Remove power steering pump (14) on compressor (1) and detach cross coupling (13)		AR46.30-W-0500A
15	Fit blocking device (18) on compressor	  Clamp blocking device with compressor in vise.	904 589 03 63 00
16	Detach drive gear (10) from compressor (1)	 	WH58.30-Z-1001-17A BA13.30-N-1005-01A
17	Remove O-ring (9) on compressor flange	 Installation: Replace O-ring.	
18	Detach connections (4, 7) on compressor cylinder head	 Installation: Replace seal!	
19	Install in the reverse order		
20.1	Check engine oil level with dipstick	Engines 904.905-907/921 Engines 904.908/923	WH0101.40 AP18.00-D-0101A
20.2  AP  AP	Inspect engine oil level at the electric gage Request engine-oil level on display Request engine-oil level on display	Models 950 - 957 Model 970- 976	AP18.00-W-0101-07A AP18.00-W-0101-07C

Nm Compressor (compressed air system)

Number	Designation	Engines 904.9, 906.9	
BA13.30-N-1004-01A	Banjo bolt, coolant line to compressor	Nm	40
BA13.30-N-1005-01A	Nut, drive gear to compressor	Nm	270
BA13.30-N-1006-01A	Bolt, compressor to crankcase	Nm	40
BA13.30-N-1007-01A	Connection of compressed air line to compressor	Nm	100
BA13.30-N-1008-01A	Connection of suction line to compressor	Nm	100

Nm Shift mechanism

Number	Designation			Transmission 715.060 with code GS3	Transmission 715.320 with code GS3	Transmissions 715.500/510/520/540 with code GS3
BA26.60-N-1009-01D	Gear hydraulic cylinder to shift shaft	Nm		60	70	50
BA26.60-N-1010-01D	Bearing bracket to transmission housing	Nm		-	-	80
BA26.60-N-1011-01D	Gate hydraulic cylinder to transmission housing	Nm		25	25	50
BA26.60-N-1012-01D	Gate hydraulic cylinder to shift shaft	Nm		35	-	50
BA26.60-N-1024-01D	Gear hydraulic cylinder to transmission housing	M10	Nm	-	45	-
		M12	Nm	-	80	-
		M14	Nm	140	-	-

Nm Shift mechanism

Number	Designation			Transmissions 715.320/321
BA26.60-N-1005-01F	Compressed-air line to control valve/gearshift cylinder	M10	Nm	20
		M12	Nm	30

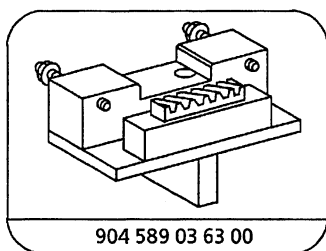

904 589 03 63 00

Blocking device

Commercially available tools (see Workshop Equipment Manual)

Number	Designation	Make (e. g.)	Order no.
WH58.30-Z-1001-17A	Three arm puller (300 mm span)	Hahn und Kolb Borsigstr. 50 D-70469 Stuttgart	55 051 040

AR26.60-W-7000-01A	Detaching, attaching shift cylinder with hydraulic line	Transmission 715.060/320/5	
--------------------	---	----------------------------	--

Modification notes

10.4.00	Figure modified from 57 Nm to 60 Nm	Figure in BA26.60-N-1009-01D for transmission 715.060 with code GS3 modified	BA26.60-N-1009-01D
---------	-------------------------------------	--	--------------------

Nm Shift mechanism

Number	Designation		Transmission 715.060 with code GS3	Transmission 715.320 with code GS3	Transmission 715.500/510/520/540 with code GS3
BA26.60-N-1009-01D	Gear hydraulic cylinder to shift shaft	Nm	60	70	50
BA26.60-N-1010-01D	Bearing bracket to transmission housing	Nm	-	-	80
BA26.60-N-1011-01D	Gate hydraulic cylinder to transmission housing	Nm	25	25	50
BA26.60-N-1012-01D	Gate hydraulic cylinder to shift shaft	Nm	35	-	50
BA26.60-N-1024-01D	Gear hydraulic cylinder to transmission housing	M10 Nm	-	45	-
		M12 Nm	-	80	-
		M14 Nm	140	-	-

Nm Shift mechanism

Number	Designation		Transmission 715.320/321
BA26.60-N-1005-01F	Compressed air line to control valve/gear shift cylinder	M10 Nm	20
		M12 Nm	30

- 1 Detach both securing clamps (2) at the hydraulic lines (1).
- 2 Detach mounting plate (4) for the hydraulic lines (1) at engine; unscrew bolts (3) for this step.

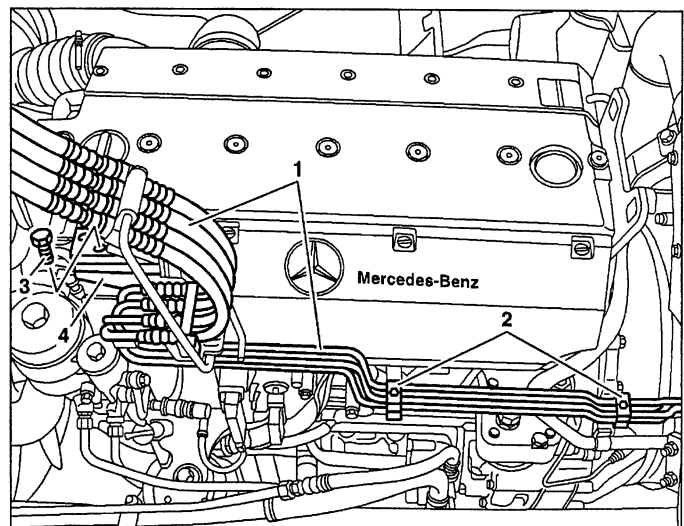

W26.60-1005-11

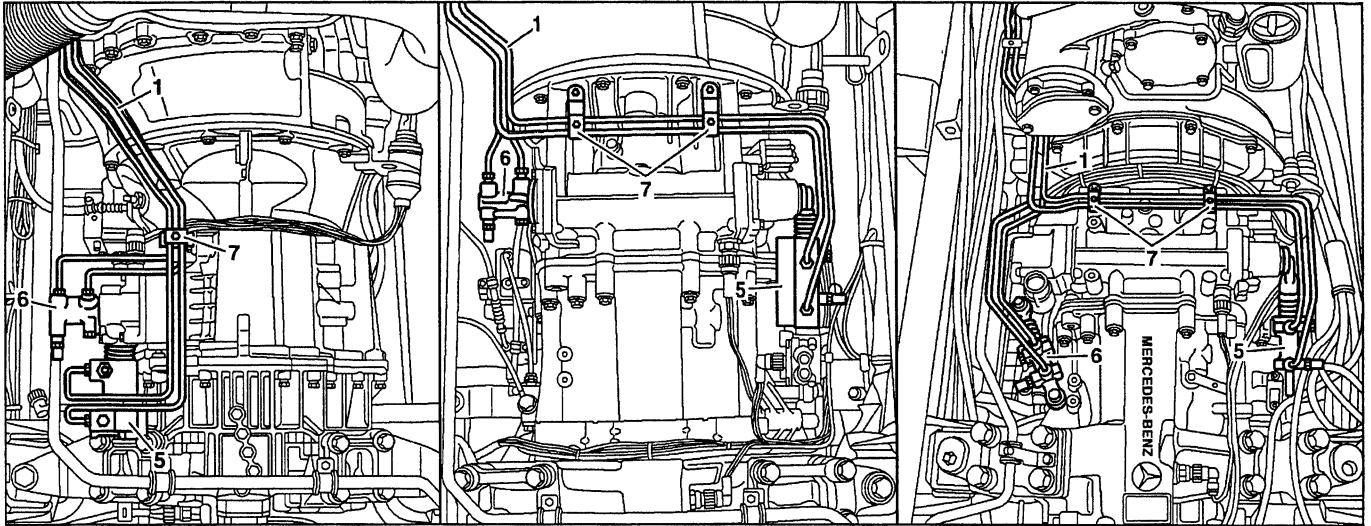

W26.60-1006-08

Hydraulic lines to transmission

Transmission 715.060

Transmission 715.320

Transmission 715.5

- | | |
|--|--|
| <p>3 Detach line attachment (7) together with hydraulic lines (1) at transmission.
 <i>i</i> Do not open the securing clamp.</p> <p>4 Detach hydraulic gate shift cylinder (6) with connected hydraulic lines (1) at transmission.
 <i>i</i> Transmission 715.320: push shift cylinder forward and lift out to the rear.</p> | <p>5 Detach hydraulic gate shift cylinder (5) with connected hydraulic lines (1) at transmission.
 <i>i</i> Transmission 715.320: additionally detach compressed air line and electrical plug connection at shift cylinder.
 Transmission 715.510: detach shift cylinder together with bearing bracket.</p> <p>6 Reinstall in opposite order.
 <i>⊗</i> Replace self-locking nuts.</p> |
|--|--|

AS00.00-Z-0013-01A	Risk of injury to skin or eyes from pressurized hydraulic fluid spraying out. Risk of poisoning from swallowing hydraulic fluid	Before starting work on the hydraulic system, depressurize the system. Wear protective clothing and safety glasses.	⚠ Danger!
--------------------	--	---	------------------

Potential danger

Risk of injury

Serious injuries can be caused to the skin or eyes when loosening hydraulic lines without depressurizing the system beforehand, due to the very high pressures (above 200 bar). Damage to the skin may be caused if unprotected skin comes into contact with hydraulic fluid, particularly central hydraulic fluid (this is especially harmful to health).

Risk of poisoning

Anyone who swallows hydraulic fluid can expect to suffer symptoms of poisoning including headaches, dizziness, stomach ache, vomiting, diarrhoea, cramps and unconsciousness

Safety measures/operating instructions

- Before starting work on hydraulic systems they should be depressurized and the system must be emptied if necessary.
- Do not pour hydraulic fluid into drinking containers.
- Ensure adequate ventilation, particularly in the case of central hydraulic fluid.

- Ensure only authorized persons have access to hydraulic fluid.
- Seal disconnected lines and hoses and connections on the subassemblies immediately with blind plugs.
- Wear safety gloves, protective clothing and safety glasses. If it is not possible to wear safety gloves, the following points are to be observed:
 - Only allow hydraulic fluid to come into contact with the skin for as short a time as possible, wash fluid off skin with soap and water.
 - Change wet clothing as quickly as possible

First aid

- Have the casualty drink plenty of water with activated charcoal additive.
- After swallowing larger quantities, consult a doctor.
- If hydraulic fluid gets into the eyes, rinse out the eyes immediately with plenty of clean water/using a eye rinsing glass.
- In the event of injuries to skin or eyes from a jet of hydraulic fluid, consult a doctor immediately.

Part 4



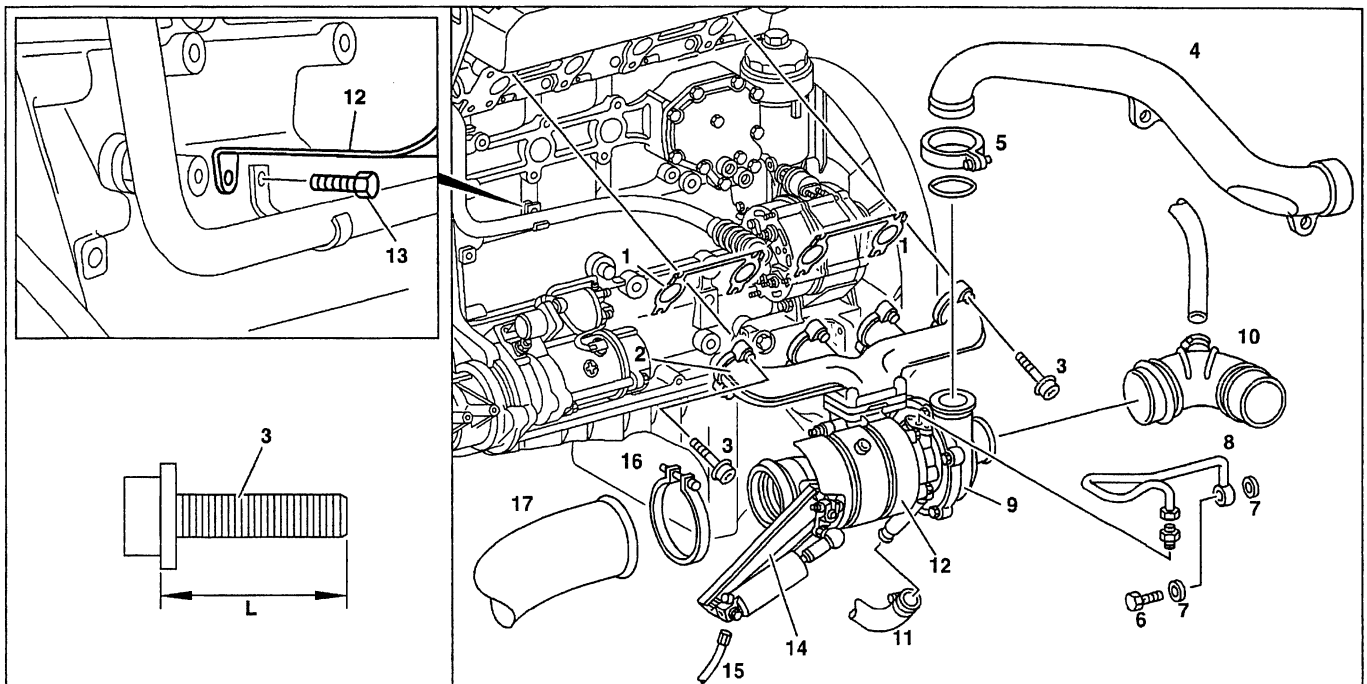











ENGINE 904.905 /906 /907 /909 /910 /911 /915 /916 /917 /921 /922, 906.910 /911 /915 /916 /919 /920 /921 /922 /923 /925 /926 /927 /928 /939 /940 /941 /942 /943 /951 /952



W14.10-0007-09

- | | | | |
|----|-----------------------|----|------------------------------|
| 1 | Gasket | 11 | Oil return flow hose |
| 2 | Exhaust manifold | 12 | Heat shield |
| 3 | Exhaust manifold bolt | 13 | Bolt |
| 4 | Boost air pipe | 14 | Engine brake flap connection |
| 5 | Clamp | 15 | Compressed air line |
| 6 | Banjo bolt | 16 | Clamp |
| 7 | Seal | 17 | Exhaust pipe |
| 8 | Oil pressure line | | |
| 9 | Turbocharger | | |
| 10 | Air intake hose | | |
- L Shank length of exhaust manifold bolt

	Removing, installing		
Danger!	Risk of explosion from explosive gas. Risk of poisoning and caustic burns from swallowing battery electrolyte. Risk of injury from caustic burns to eyes and skin from battery electrolyte or from handling damaged lead acid batteries.	No fire, sparks, naked flames or smoking. Wear acid-resistant gloves, protective clothing and eye protection. Pour battery electrolyte only into suitable and appropriately marked containers.	Page 6
1	Disconnect battery		
	Notes on battery	All models	Page 7
Danger!	Risk of injury from hand being jammed and bruised when tilting cab	No person must be within the tilting range of the cab when the cab is tilted. Always tilt cab as far as the end position and secure with safety prop.	Page 8
2.1	Tilt cab into repair position	Models 673-679	AR60.80-W-0010A
2.2	Tilt cab	Models 950-954, 957, 970-976	
	Notes on tilting cab	Models 375, 673-679, 950-954, 957, 970-976	Page 8

3	Remove noise encapsulation on right and at bottom		
4	Remove charge air pipe (4)	Engine 904.905- 907/921 Engine 904.909-911/915-917/922 Engine 906.910/911/915/916/919-923/ 925-928/939/940/941/942/943/951/952	AR09.41-W-1311A AR09.41-W-1311C
5	Detach exhaust pipe (17) at engine brake flap connection (14)	 Installation: Clean sealing surfaces	
6	Detach compressed air line (15) at engine brake cylinder		
7	Detach heat shield (12) at turbocharger (9) and at crankcase	 Installation: Engine 904.905-907/921: fit on heat shield and compressor suction line together at crankcase.	
8	Detach oil return flow hose (11) at turbocharger (9)	 Collect engine oil which flows out.	
9	Detach oil pressure line (8) at oil filter and at turbocharger (9)	Seal hole at turbocharger and at crankcase.  Installation: Before fitting on the oil pressure line, fill the turbocharger bearing housing through the oil filler hole with engine oil. Rotate the turbocharger shaft by hand during this step so that the bearing points are provided with a film of oil. 	BA09.40-N-1002-01B
10	Detach air intake hose (10) at turbocharger (9)		
11	Remove exhaust manifold (2), turbocharger (9) and engine brake flap connection (14) together	 Only slacken rear exhaust manifold bolt (3) in the bottom row, exhaust manifold is suspended at this bolt. 	BA14.10-N-1001-01B
12	Inspect exhaust manifold bolts (3)	 Installation: If the maximum shank length (L) is exceeded, replace exhaust manifold bolts.	BE14.10-N-1001-01A
13	Take off gaskets (1)	 Installation: Replace gaskets.	
14	Detach turbocharger (9) together with engine brake flap connection (14) at exhaust manifold (2)	 Seal holes at turbocharger with caps.  Installation: Replace nuts.	BA09.40-N-1001-01B
15	Install in the reverse order		
16.1	Check engine oil level with dipstick	Engine 904.905- 907/921	WH0101.40
16.2	Check engine oil level at electric gage		
 AP	Request engine oil level in display	Model 950 - 957	AP18.00-W-0101-07A
 AP	Request engine oil level in display	Model 970- 976	AP18.00-W-0101-07C
 Danger!	Risk of accident from vehicle starting off by itself when engine running. Risk of injury from bruises and burns if you hold your hand into engine when it is started or when it is running.	Secure vehicle to prevent it moving off by itself. Wear closed and close-fitting work clothes. Do not grasp hot or rotating parts.	Page 9

17	Start engine and observe oil pressure gage at idle speed	<p>ⓘ Start engine by cranking with starter for not more than 90 s. Wait about 2 minutes at least before repeating start operation.</p> <p>Motor nicht hochdrehen solange noch kein Öldruck angezeigt wird.</p> <p>ⓘ The oil pressure gage must indicate oil pressure after about 10 s.</p>	BE18.00-N-1001-01C
18	Switch off engine and inspect for leaks		

Inspection data of exhaust manifold

Number	Designation	Engine 904.9, 906.9
BE14.10-N-1001-01A	Exhaust manifold bolts	Thread diameter M 10
		Shank length when new mm 47.0
		Shank length mm ≤ 47.5

Test data of engine oil pressure

Number	Designation	Engine 904.9, 906.9
BE18.00-N-1001-01C	Engine oil pressure at	Idle speed bar ≥ 0.5
		Maximum speed bar ≥ 2.5

Turbocharger

Number	Designation		Engine 904.9	Engine 906.9
BA09.40-N-1001-01B	Nut of turbocharger to exhaust manifold	Nm	30	50
BA09.40-N-1002-01B	Bolt of oil pressure line to turbocharger	M8 Nm	40	40
		M6 Nm	10	10

Exhaust manifold

Number	Designation	Engine 904.9, 906.9
BA14.10-N-1001-01B	Bolt of exhaust manifold to cylinder head	1st stage Nm 10
		2nd stage Nm 55
		3rd stage \sphericalangle° 90

AS54.10-Z-0001-01A	Explosion hazard from explosive gas. Danger of poisoning and acid burns when battery acid is swallowed. Danger of acid burns to skin and eyes from battery acid or when handling damaged lead-acid batteries.	Flames, sparks, open light and smoking prohibited. Wear acid resistant gloves, clothing and goggles. Store battery acid only in suitable, appropriately marked containers.	 Danger!
--------------------	---	--	--

Possible dangers

Explosion hazard

A highly explosive gas mixture is generated when lead-acid batteries are charged

Poisoning hazard

When battery acid is taken orally toxic symptoms can occur such as headache, dizziness, stomach pain, paralysis of the respiratory system, unconsciousness, vomiting, acid burns and cramps.

Battery acid vapor can burn eyes. Inhalation can result in burns to mucous membranes and respiratory paths.

Lead in the body can damage blood, nerves and kidneys; moreover, lead compounds pose a hazard for the reproduction organs.

- Keep lead-acid batteries and battery acid away from unauthorized persons.
- Store battery acid only in suitable, appropriately marked containers.
- Store lead-acid batteries only in upright position.
- Ensure that gassing line is properly connected.
- Check gassing line for kinks and proper passage.
- Observe instructions for applicable lead-acid battery and vehicle operating instructions.
- Wear acid protective clothing and protective goggles with side guard.

Injury hazard

Battery acid contains sulfuric acid, which can cause severe burns to skin and eyes. When handling damaged lead-acid batteries (removing from accident vehicle) increased care is necessary due to the sharp edges on the broken housing and direct contact with the lead plates.

Rules of behavior/protective measures

- Charge lead-acid batteries only in well ventilated rooms.
- Fire, sparks, open light and smoking prohibited.
- Do not lay tools or other conductive items on lead-acid batteries (danger of short circuiting).
- Disconnect and remove lead-acid batteries for charging.
- Always disconnect negative pole first; always connect positive pole first.
- Switch on charger only after connecting to poles; switch off before disconnecting.

First-aid measures

Eye contact

- Rinse eyes immediately with large quantities of water.

Skin contact

- Remove affected clothing.
- Neutralize acid on skin or clothing immediately with acid neutralizer or soap solution and rinse with large quantities of water.

Inhalation of battery acid vapor

- Move affected person to fresh air

Swallowing battery acid

- Have person drink large quantities of water containing activated charcoal.

Generally medical services or a physician should be contacted after administering first aid.

Fire protection measures

Suitable extinguishing agents

- CO₂ and dry extinguishing agents.

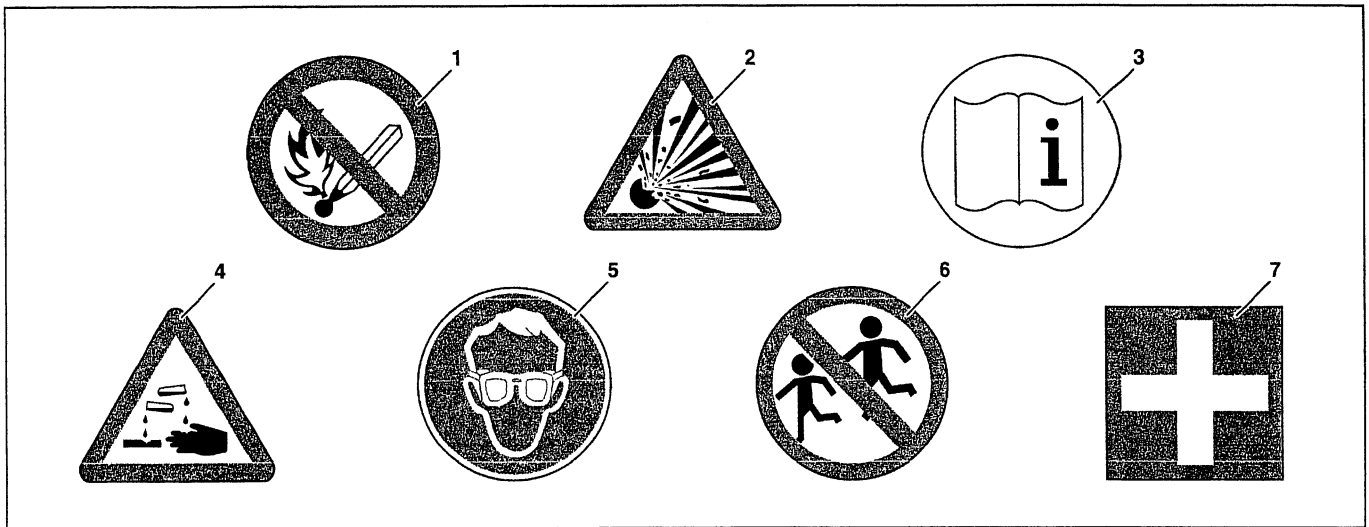

P54.10-0270-08

Warning notes on lead acid batteries

- | | | | | | |
|---|---|---|--------------------------------|---|-------------------------|
| 1 | Fire, sparks, open light and smoking prohibited | 3 | Observe operating instructions | 6 | Keep away from children |
| 2 | Explosion hazard | 4 | Danger of acid burns | 7 | First aid |
| | | 5 | Wear eye protection | | |

AH54.10-P-0001-01A	Notes on battery	All models	
--------------------	------------------	------------	--



- Do not store lead-acid batteries for extended periods of time in a place where they are exposed to direct sunlight.
 - Always store lead-acid batteries horizontally to prevent acid from escaping; do not tilt them when they are being transported.
 - Discharged or faulty lead-acid batteries can freeze up; therefore, ensure that they are stored at temperatures above freezing level.
 - Do not place any tools or other electrically conductive objects on a lead-acid battery (risk of short-circuit!).
 - Avoid mixing up positive and negative poles and avoid short-circuits.
 - Before removing or installing a lead-acid battery, switch off all electrical consumers where possible, and switch off the engine, so as to minimize the possibility of creating sparks.
 - Always disconnect the negative pole first; always connect the positive pole first.
- Do not switch on battery chargers until they have been connected to the battery poles; switch them off before disconnecting.
 - Only charge lead-acid batteries with direct current. For the charging current we recommend 10% of capacity for normal charging and 50% of capacity for rapid charging.
 - During rapid charging it must be insured that the casing of the lead-acid battery does not warm up excessively (< 55 °C).
 - Lead-acid batteries should be kept clean and dry as far as possible.
 - It is advisable to grease the poles lightly with battery pole grease.
 - Lead-acid batteries should not be stored for extended periods without being recharged.
 - If a lead-acid battery is to remain in a vehicle which is not in use for an extended period, the negative terminal clamp should be disconnected.

AS60.80-Z-0001-01A	Injury hazard from pinching and crushing when cab is tilted	When tilting ensure that no one is present in the tilting area of the cab. Always tilt cab to end position and secure with safety brace.	 Danger!
--------------------	---	--	--

Injury hazard

A damaged tilting mechanism or improper handling of the tilting mechanism can lead to severe injuries when tilting the cab.

Rules of behavior/protective measures

Before tilting cab:

- Shut off engine.
- Apply parking brake.
- Secure vehicle against rolling.
- On vehicles with manual transmission, move shift lever to neutral position.
- On vehicles with automatic transmission, move selection lever to position "N":

When tilting the cab:

- Protect tilting area and particularly tilting device against unauthorized access, e.g. by blocking off or with human guard.
- Attach safety cable before tilting when so specified in the vehicle operating instructions.
- Never work under cab when partially tilted.
- Always tilt cab to end position and secure with safety brace.

AH60.80-N-0003-01A	Notes on tilting cab	Model 375, 673, 674, 675, 676, 677, 678, 679, 684, 950, 952, 953, 954, 957, 970, 971, 972, 973, 974, 975, 976	
--------------------	----------------------	---	---

Prior to tilting cab:

- Switch off engine
- Apply parking brake
- Secure vehicle to prevent it moving off
- Remove all loose objects (e.g. cans, bottles, tools, bags etc.) from the cab
- Models fitted with manual transmission: move shift lever into Neutral
- Model 957: unlock steering column and open front flap.

Models fitted with refrigeration compartment

- The refrigeration compartment must be switched off before tilting the cab.
- The refrigeration compartment must not be switched on again until 10 minutes after tilting back the cab.
 Refer also to operating instructions of refrigeration compartment manufacturer and red information sticker on the refrigeration compartment.

The front coupling pin must be correctly inserted.



- Always tilt cab as far as the end position.
- After tilting cab, support with a prop.
- If no resistance can be felt when operating the cab tilting pump, check whether sufficient oil is present in the tilting pump.
- If a firm resistance can be felt when operating the cab tilting pump, check whether the valve lever at the tilting pump is in the desired tilting direction.

AS00.00-Z-0005-01A	Risk of accident as a result of vehicle starting off when engine is running. Risk of injury as a result of bruises and burns if you insert your hands into engine when it is being started or when it is running.	Secure vehicle to prevent it from moving off. Wear closed and close-fitting work clothes. Do not grasp hot or rotating parts.	 Danger!
--------------------	---	---	--

Possible dangers

Risk of accident

from vehicle starting off during starting operation (e.g. when testing compression pressure) as a result of gear engaged or when engine running and vehicles with automatic transmission as a result of selector lever position "P" or "N" not engaged (exception: some vehicles do not have a selector lever position "P").

Risk of injury

Severe injuries may be caused by freely rotating parts in the area of the running engine. The heat produced by the engine when it is operating can result in severe burns if contact is made with individual, unshielded parts.

Rules of conduct / Protective measures

- As a general rule, carry out work on the running engine only if this is absolutely essential.
- Before starting the engine, **apply parking brake**.
- On models with manual transmission, **move gearshift lever into Neutral position**.
- On models with automatic transmission, **move selector lever into position "P" or "N"** (exception: some vehicles do not have a selector lever position "P").
- On models which **do not have selector lever position "P"**, **secure selector lever to prevent it from being operated unintentionally**.
- Wear closed and close-fitting work clothes.
- Take off any jewelry, such as chains, rings etc.
- If you have long hair, wear a suitable head cover.
- Before commencing work on the running engine, check to obtain a general picture of the positioning of parts which may be hot.
- When carrying out work when starting the engine or when engine is running, **do not touch any hot and rotating parts**.

First aid measures in the event of burns

- Do not rub the skin areas affected; flush with plenty of cold water and cover skin with sterile bandages.
- Immediately consult a physician.

ENGINE 904.905 /906 /907 /909 /910 /911 /915 /916 /917 /921 /922

- 1 Engine brake flap connection
- 2 Turbocharger
- 3 Heat shield
- 4 Compressed air line
- 5 Exhaust pipe

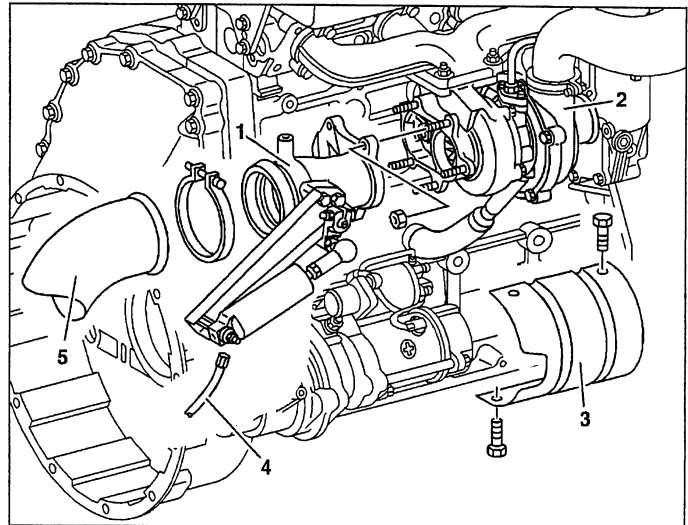

W14.15-1004-11

	Removing, installing		
Danger!	Risk of explosion from explosive gas. Risk of poisoning and caustic burns from swallowing battery electrolyte. Risk of injury from caustic burns to eyes and skin from battery electrolyte or from handling damaged lead acid batteries.	No fire, sparks, naked flames or smoking. Wear acid-protective gloves, clothing and eye protection. Pour battery electrolyte only into suitable and appropriately marked containers.	Page 6
1	Disconnect battery		
	Notes on battery	All models	Page 7
Danger!	Risk of injury from hand being jammed and bruised when tilting cab	No person must be within the tilting range of the cab when the cab is tilted. Always tilt cab as far as the end position and secure with safety prop.	Page 8
2	Tilt cab		
	Notes on tilting cab	Models 375, 673- 679, 970- 976	Page 8
3	Remove noise encapsulation panels		
4	Take off heat shield (3)	Installation: Engine 904.905- 907/921: Attach heat shield together with air intake line of compressor to the crankcase.	
5	Detach exhaust pipe (5) at engine brake flap connection (1)		
6	Detach compressed air line (4) at engine brake cylinder		
7	Detach engine brake flap connection (1) and bracket	Installation: Replace nuts.	
			BA14.10-N-1002-01B
8	Install in the reverse order		

Nm Exhaust manifold

Number	Designation	Engine 904.9, 906.9
BA14.10-N-1002-01B	Nut of engine brake flap connection to turbocharger	M8 Nm 30
		M10 Nm 50

ENGINE 906.910 /911 /915 /916 /919 /920 /921 /922 /923 /925 /926 /927 /928 /939 /940 /941 /942 /943 /951 /952

- 1 Exhaust pipe
- 2 Clamp
- 3 Engine brake flap connection
- 4 Compressed air line
- 5 Heat shield

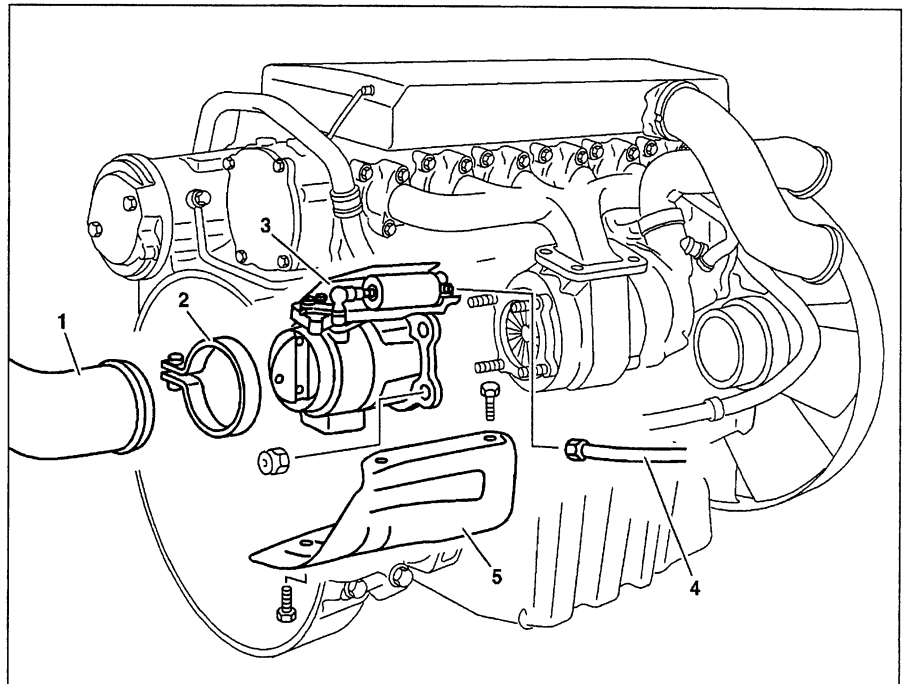

W14.15-1002-06

	Removing, installing		
Danger!	Risk of explosion from explosive gas. Risk of poisoning and caustic burns from swallowing battery electrolyte. Risk of injury from caustic burns to eyes and skin from battery electrolyte or from handling damaged lead acid batteries.	No fire, sparks, naked flames or smoking. Wear acid-resistant gloves, protective clothing and eye protection. Pour battery electrolyte only into suitable and appropriately marked containers.	Page 6
1	Disconnect battery		
	Notes on battery	All models	Page 7
Danger!	Risk of injury from hand being jammed and bruised when tilting cab	No person must be within the tilting range of the cab when the cab is tilted. Always tilt cab as far as the end position and secure with safety prop.	Page 8
2	Tilt cab		
	Notes on tilting cab	Models 375, 950-954, 957, 970-976	Page 8
3	Remove noise encapsulation panels		
4	Remove bracket at engine brake flap connection (3) and at air intake manifold	Only engine 906.940/941/942/943/951/952	
5	Remove exhaust pipe (1) at engine brake flap connection (3) and at the rear suspension eye	Installation: Inspect clamp (2) for wear, replace if necessary.	
6	Take off heat shield (5) at engine brake flap connection (3) and at turbocharger		
7	Detach compressed air line (4) at engine brake cylinder		
8	Detach engine brake flap connection (3)	Installation: Replace nuts. 	BA14.10-N-1002-01B

9	Install in the reverse order		
---	------------------------------	--	--

Nm Exhaust manifold

Number	Designation	Engine 904.9, 906.9		
BA14.10-N-1002-01B	Nut of engine brake flap connection to turbocharger	M8	Nm	30
		M10	Nm	50



ENGINE 904.905 /906 /907 /908 /909 /910 /911 /915 /916 /917 /921 /922 /923

- 1 Engine brake flap connection
- 2 Bearing bush
- 3 Engine brake shaft
- 4 Engine brake flap
- 5 Bolt
- 6 Bracket
- 7 Bolt
- 8 Bolt
- 9 Adjusting lever
- 10 Nut
- 11 Ball socket
- 12 Nut
- 13 Engine brake cylinder
- 14 Nut
- 15 Washer
- 16 Pin
- 17 Nut
- 18 Fuse

Position of engine brake flap/
adjusting lever

- B opened
C closed

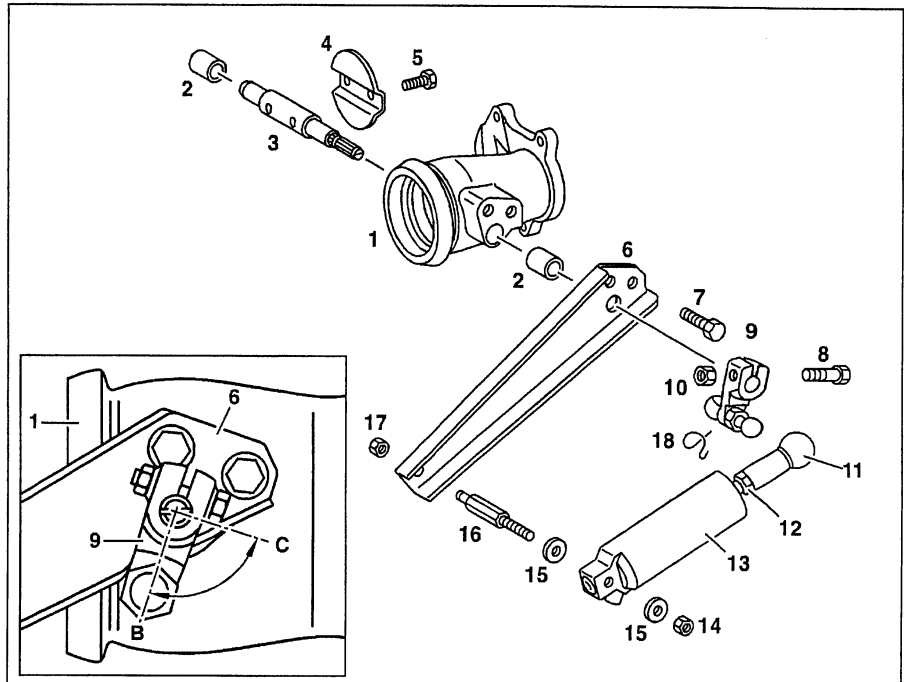

W14.15-0010-06





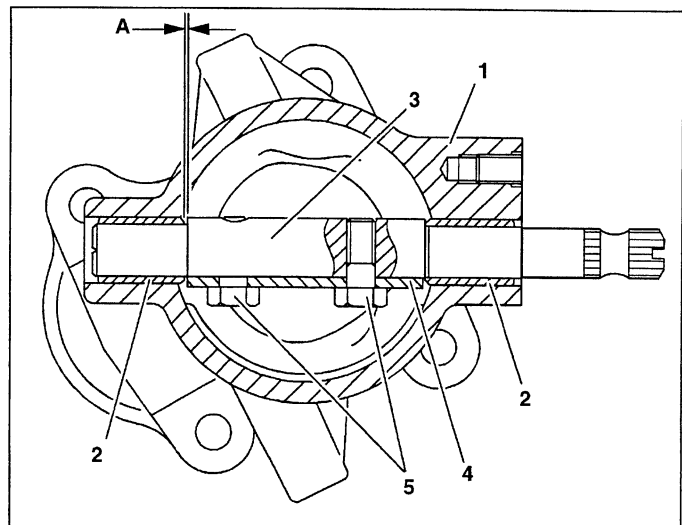







- 1 Engine brake flap connection
- 2 Bearing bush
- 3 Engine brake shaft
- 4 Engine brake flap
- 5 Bolt

A Axial play of engine brake shaft



W14.15-0003-11

☑	Disassembling		
1	Remove engine brake flap connection (1)	Engine 904.905-907/909-911/915-917/ 921/923 Engine 904.908/923	Page 10 AR14.15-D-6302D
2	Remove engine brake cylinder (13)	Release ball socket (18).	
3	Take off adjusting lever (9)		
4	Detach bracket (6)		
5	Remove engine brake flap (4)	i Close engine brake flap for this step.	
6	Remove engine brake shaft (3) and bearing bushes (2)	i Use a suitable drift.	

	Assembly		
7	Install bearing bush (2) on the bracket side	<p> With projection (approx. 3 mm) to inner contact surface. Use a suitable drift.</p> <p> Coat bearing point with hot lubricating paste.</p>	<p>WH58.30-Z-1012-12A</p> <p>BR00.45-Z-1006-06A</p>
8	Insert engine brake flap (4) into the engine brake flap connection (1) and push engine brake shaft (3) through	<p> Coat bearing point with hot lubricating paste.</p>	BR00.45-Z-1006-06A
9	Knock in second bearing bush (2)	<p> Center engine brake shaft (3) relative to flap connection diameter. Projection of both bearing bushes to inner contact surface must be the same. Use a suitable drift.</p>	
10	Knock back bearing bushes (2) evenly on both sides sufficiently far until the axial play (A) of the engine brake shaft (3) is achieved	<p> Use a suitable drift.</p> <p></p>	<p>BE14.15-N-1004-01B</p> <p>WH58.30-Z-1008-12A</p>
11	Tighten engine brake flap (4) fully	<p> When the engine brake flap is closed, bolt heads (5) must point toward the engine. Center engine brake flap in engine brake flap connection (1). Engine brake flap must be resting against flap connection stop in the closed position.</p>	
12	Measure annular gap at engine brake flap (4)	<p> Engine brake flap must not be touching the flap connection passage radially in the closed position.</p> <p></p>	WH58.30-Z-1008-12A
13	Fit on bracket (6)		
14	Install adjusting lever (9)	<p> Fit adjusting lever onto the splines of the engine brake shaft (3) so that the adjusting lever stop is resting against the bracket (6) when the engine brake flap is fully opened (4, position B).</p>	
15	Inspect setting of engine brake flap (4)	<p>When the engine brake flap is closed (position C) the adjusting lever stop must not be touching the bracket (6) (clearance approx. 1 mm).</p>	
16	Install engine brake cylinder (13)	<p> Replace nut (14).</p>	BE14.15-N-1001-01B
17	Set preload of engine brake cylinder (13) and secure engine brake cylinder	<p> When the engine brake flap (4) is opened (position B) turn the ball socket (11) (about 2 turns) until the specified setting is achieved.</p>	BE14.15-N-1002-01B
18	Install engine brake flap connection (1)	<p>Engine 904.905-907/909-911/915-917/921/922</p> <p>Engine 904.908/923</p>	<p style="text-align: right;">Page 10</p> <p>AR14.15-D-6302D</p>

Inspection data of engine brake

Number	Designation	Engine 904.9, 906.9
BE14.15-N-1001-01B	Setting of engine brake cylinder	mm 180.3
BE14.15-N-1002-01B	Engine brake cylinder pretension	mm 1.0-2.0
BE14.15-N-1004-01B	Engine brake shafts - axial play between bushes	mm 0.3-0.5

Commercially available tools (see Workshop Equipment Manual)

Number	Designation	Make (e. g.)	Order no.
WH58.30-Z-1008-12A	Feeler gauge	Stiefelmayer D-73734 Esslingen	59
WH58.30-Z-1012-12A	Depth gage, range 0 - 200 mm	Stiefelmayer D-73734 Esslingen	040 202

Repair products

Number	Designation	Order no.
BR00.45-Z-1006-06A	Hot lubricating paste	000 989 76 51

ENGINE 906.910 /911 /915 /916 /919 /920 /921 /922 /923 /925 /926 /927 /928 /939 /940 /941 /942 /943

- 1 Engine brake flap connection
- 2.1 Bearing bush
- 2.2 Bearing bush
- 3 Engine brake shaft
- 4 Engine brake flap
- 5 Bolt
- 6 Bracket
- 7 Bolt
- 8 Spacer bush
- 9 Nut
- 10 Engine brake cylinder
- 10.1 Nut
- 10.2 Ball socket
- 11 Fuse
- 12 Adjusting lever
- 13 Nut
- 14 Bolt

**Position of engine brake flap/
adjusting lever**

- B opened
- C closed

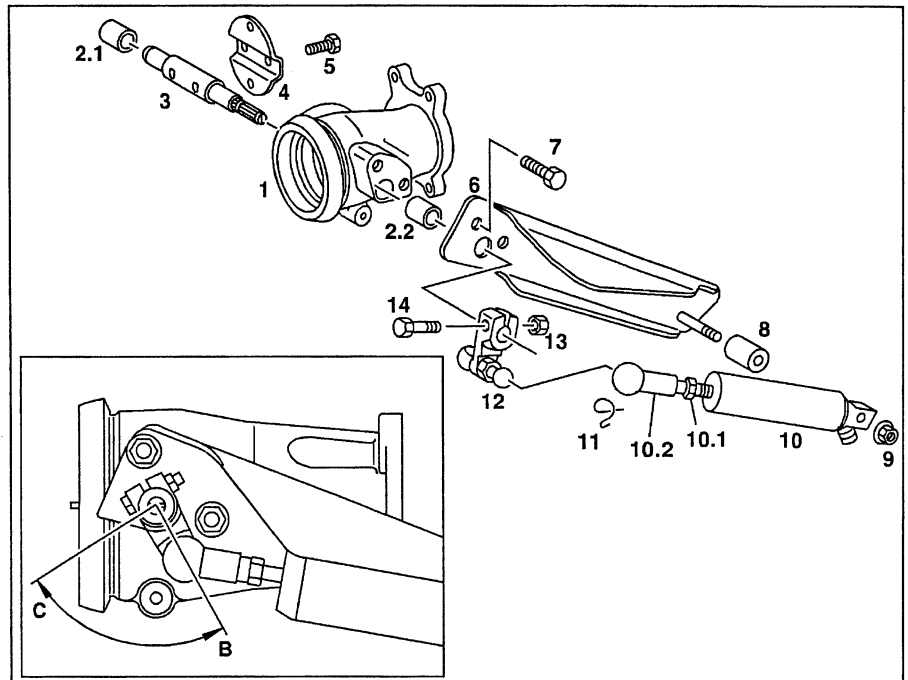





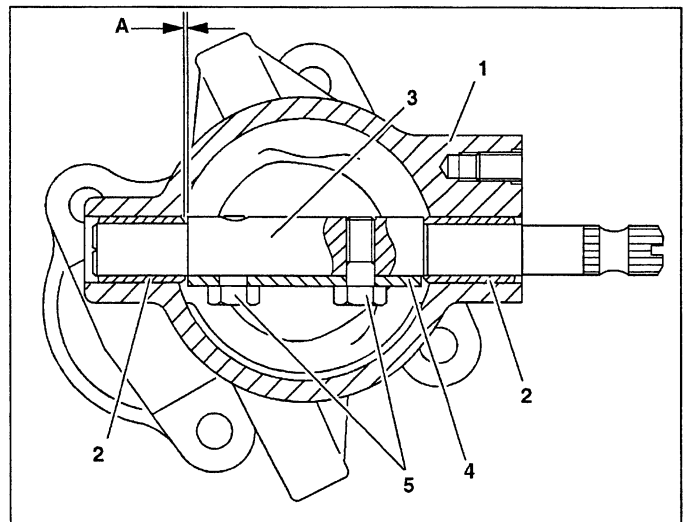





W14.15-1001-06

- 1 Engine brake flap connection
 - 2 Bearing bush
 - 3 Engine brake shaft
 - 4 Engine brake flap
 - 5 Bolt
- A Axial play of engine brake shaft



W14.15-0003-11

	Disassembling		
1	Remove engine brake flap connection (1)		Page 12
2	Remove engine brake cylinder (10)	Unlock ball socket (10.2).	
3	Take off spacer bush (8)		
4	Take off adjusting lever (12)		
5	Detach bracket (6)		
6	Remove engine brake flap (4)	i Close engine brake flap for this step.	
7	Remove engine brake shaft (3) and bearing bushes (2.1, 2.2)	i Use a suitable drift.	
	Assembly		

8	Install bearing bush (2.2) on the bracket side	<p> With projection (approx. 3 mm) to inner contact surface. Use a suitable drift.</p> <p> Coat bearing point with hot lubricating paste.</p>	<p>WH58.30-Z-1012-12A</p> <p>BR00.45-Z-1006-06A</p>
9	Insert engine brake flap (4) into the engine brake flap connection (1) and push engine brake shaft (3) through	<p> Coat bearing point with hot lubricating paste.</p>	BR00.45-Z-1006-06A
10	Knock in second bearing bush (2.1)	<p> Center engine brake shaft (3) relative to flap connection diameter. Projection of both bearing bushes to inner contact surface must be the same. Use a suitable drift.</p>	
11	Knock back bearing bushes (2.1, 2.2) evenly on both sides and sufficiently until axial play (A) of engine brake shaft (3) is achieved	<p> Use a suitable drift.</p> <p></p>	<p>BE14.15-N-1004-01B</p> <p>WH58.30-Z-1008-12A</p>
12	Tighten engine brake flap (4) fully	<p> When the engine brake flap is closed, bolt heads (5) must point toward the engine. Center engine brake flap in engine brake flap connection (1). Engine brake flap must be resting against flap connection stop in the closed position.</p>	
13	Measure annular gap at engine brake flap (4)	<p> Engine brake flap must not be touching the flap connection passage radially in the closed position.</p>	
14	Fit on bracket (6)		
15	Install adjusting lever (12)	<p> Fit adjusting lever onto the splines of the engine brake shaft (3) so that the adjusting lever stop is resting against the bracket (6) when the engine brake flap is fully opened (4) (position B).</p>	
16	Inspect setting of engine brake flap (4)	<p>When the engine brake flap is opened (position B) the adjusting lever stop must not be touching the bracket (6) (clearance approx. 1 mm).</p>	
17	Install spacer bush (8)		
18	Install engine brake cylinder (10)	<p> Replace nut (9).</p>	
19	Set preload of engine brake cylinder (13) and secure engine brake cylinder	<p> When the engine brake flap (4) is opened (position B) turn the ball socket (10) (about 2 turns) until the specified setting is achieved.</p> <p>Pay attention to setting of engine brake cylinder.</p>	<p>BE14.15-N-1002-01B</p> <p>BE14.15-N-1001-01B</p>
20	Install engine brake flap connection (1)		Page 10

Inspection data of engine brake

Number	Designation	Engine 904.9, 906.9
BE14.15-N-1001-01B	Setting of engine brake cylinder	mm 180.3
BE14.15-N-1002-01B	Engine brake cylinder pretension	mm 1.0-2.0
BE14.15-N-1004-01B	Engine brake shafts - axial play between bushes	mm 0.3-0.5

Commercially available tools (see Workshop Equipment Manual)

Number	Designation	Make (e. g.)	Order no.
WH58.30-Z-1008-12A	Feeler gauge	Stiefelmayer D-73734 Esslingen	59
WH58.30-Z-1012-12A	Depth gage, range 0 - 200 mm	Stiefelmayer D-73734 Esslingen	040 202

Repair products

Number	Designation	Order no.
BR00.45-Z-1006-06A	Hot lubricating paste	000 989 76 51

ENGINE 904.905 /906 /907 /909 /910 /911 /915 /916 /917 /921 /922, 906.910 /911 /915 /916 /919 /920 /921 /922 /923 /925 /926 /927 /928 /939 /940 /941 /942 /943 /951 /952

- 1 Control line
 2 Starter cable
 3 Nut
 4 Washer
 5 Bracket
 6 Wiring harness
 7 Ground cable

M1 Starter

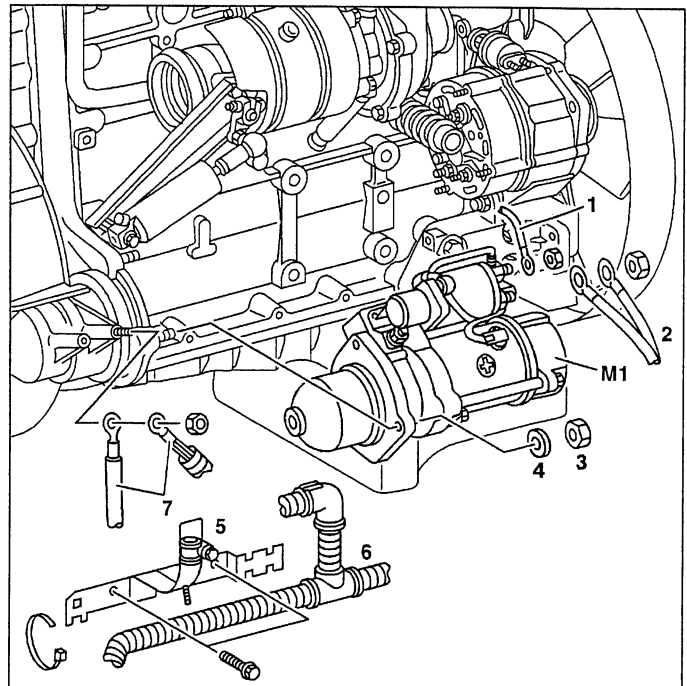

W15.30-0004-12

	Removing, installing		
Danger!	Risk of explosion from explosive gas. Risk of poisoning and caustic burns from swallowing battery electrolyte. Risk of injury from caustic burns to eyes and skin from battery electrolyte or from handling damaged lead acid batteries.	No fire, sparks, naked flames or smoking. Wear acid-resistant gloves, protective clothing and eye protection. Pour battery electrolyte only into suitable and appropriately marked containers.	Page 6
1 	Disconnect battery Notes on battery	All models	Page 7
Danger!	Risk of injury from hand being jammed and bruised when tilting cab	No person must be within the tilting range of the cab when the cab is tilted. Always tilt cab as far as the end position and secure with safety prop.	Page 8
2 	Tilt cab Notes on tilting cab	Models 375, 673-679, 950-954, 957, 970-976	Page 8
3	Remove noise encapsulation panels		
4	Detach wiring harness (6) at bracket (5)		
5	Detach bracket (5) at crankcase		
6	Disconnect ground cables (7) at timing case		
7	Detach control line and starter cable (1, 2) at starter (M1)		
8	Take off starter (M1)	Installation: Lightly grease starter pinion and ring gear of flywheel. 	BR00.45-Z-1001-06A BA15.30-N-1001-01B
9	Inspect starter pinion for wear	If wear present, replace starter.	

10	Inspect ring gear of flywheel for wear	 If wear present: ↓ Replace ring gear of flywheel	AR03.30-W-8312A
11	Install in the reverse order		

Nm Starter

Number	Designation	Engine 904.9, 906.9
BA15.30-N-1001-01B	Nut of starter to timing case	Nm 50

Repair products

Number	Designation	Order no.
BR00.45-Z-1001-06A	MB long-term grease	000 989 63 51

ENGINE 904.905 /906 /907 /909 /910 /911 /915 /916 /917 /921 /922, 906.910 /911 /915 /916 /919 /920 /921 /922 /923 /925 /926 /927 /928 /939 /942 /943

- 1 Air intake hose
 2 Bolt
 3 Poly V-belt
 4 Nut
 5 Bolt
 6 Support
 7 Bolt
 8 Wiring harness
 9 Bracket
 G1 Generator

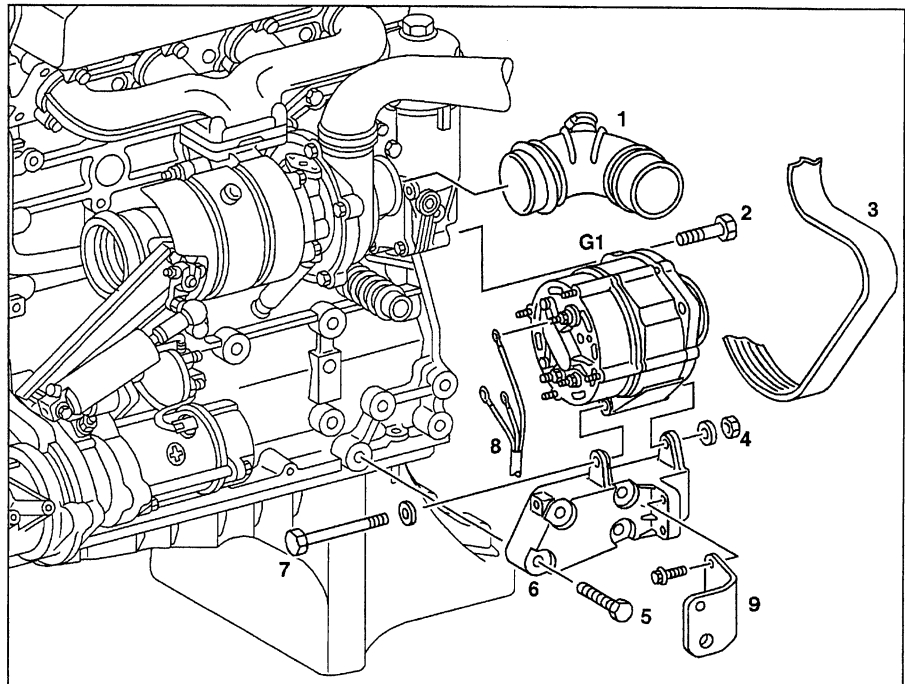

W15.40-0004-06

	Removing, installing		
Danger!	Risk of explosion from explosive gas. Risk of poisoning and caustic burns from swallowing battery electrolyte. Risk of injury from caustic burns to eyes and skin from battery electrolyte or from handling damaged lead acid batteries.	No fire, sparks, naked flames or smoking. Wear acid-resistant gloves, protective clothing and eye protection. Pour battery electrolyte only into suitable and appropriately marked containers.	Page 6
1 	Disconnect battery Notes on battery	All models	Page 7
Danger!	Risk of injury from hand being jammed and bruised when tilting cab	No person must be within the tilting range of the cab when the cab is tilted. Always tilt cab as far as the end position and secure with safety prop.	Page 8
2 	Tilt cab Notes on tilting cab	Models 375, 673-679, 950-954, 957, 970-976	Page 8
3	Remove noise encapsulation panels		
4	Remove air intake hose (1)		
5	Remove charge air pipe from charge air cooler to charge air manifold		AR09.41-W-1311D
6	Remove bracket (9) at support (6)		
7	Slacken poly V-belt (3) and take off		AR13.22-W-1202A
8	Disconnect wiring harness (8) at generator (G1)	Pay attention to color coding of cables.	
9	Take off generator (G1) at bracket		BA15.40-N-1003-01B

10	Remove generator (G1) together with support (6)	Nm	BA01.40-N-1003-01C
11	Take off generator (G1) at support (6)	Nm	BA15.40-N-1002-01B
12	Inspect belt pulley of generator for damage and concentric running	i If wear present: ↓ Replace belt pulley.	Page 24
13	Install in the reverse order		

Nm Crankcase, timing case cover, end cover

Number	Designation	Engine 904.9, 906.9
BA01.40-N-1003-01C	Bolt of generator carrier too crankcase	Nm 100

Nm

Number	Designation	Engine 904.9, 906.9
BA15.40-N-1002-01B	Nut of generator to support	Nm 50
BA15.40-N-1003-01B	Bolt of generator to bracket	Nm 65

ENGINE 904.905 /906 /907 /909 /910 /911 /915 /916 /917 /921 /922, 906.910 /911 /915 /916 /919 /920 /921 /922 /923 /925 /926 /927 /928 /939 /942 /943

- 1 Poly V-belt
 2 Nut
 3 Belt pulley
 4 Fan wheel
 G1 Generator

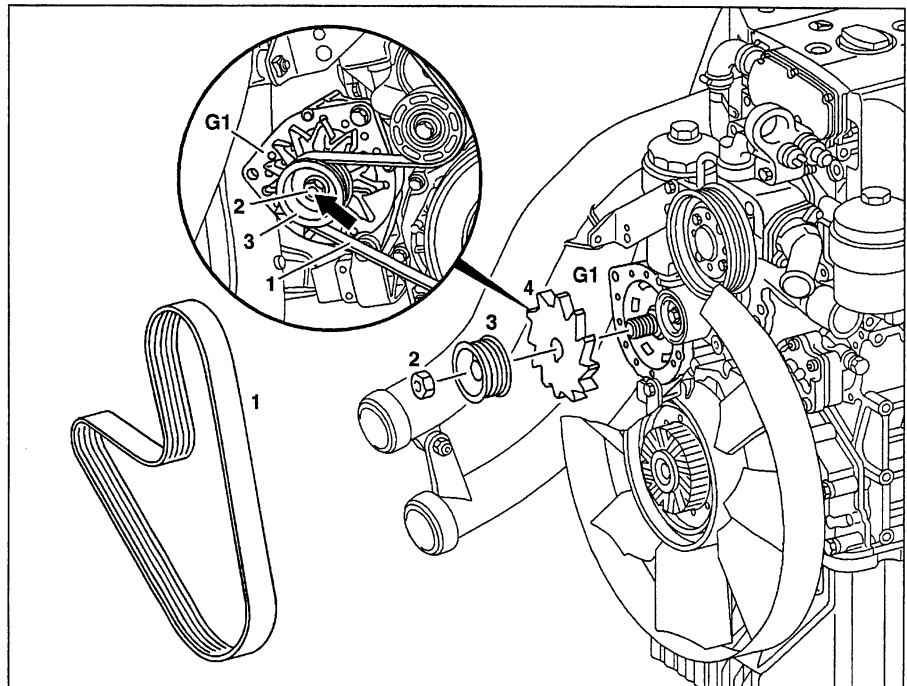

W15.40-0006-06

Modification notes

7.7.98	Tightening torque of nut of belt pulley to generator modified	Step 4	
--------	---	--------	--

	Removing, installing		
Danger!	Risk of injury from hand being jammed and bruised when tilting cab	No person must be within the tilting range of the cab when the cab is tilted. Always tilt cab as far as the end position and secure with safety prop.	Page 8
1	Tilt cab		
	Notes on tilting cab	Models 375, 673-679, 950-954, 970-976	Page 8
2	Remove noise encapsulation panels		
3	Remove air intake hose		
4	Slacken nut (2) at the belt pulley (3)	Counterhold generator shaft with hexagon socket wrench. 	BA15.40-N-1004-01B
5	Slacken poly V-belt (1) and take off		AR13.22-W-1202A
6	Take off belt pulley (3) and fan wheel (4) at generator		
7	Install in the reverse order		

Nm

Number	Designation	Engine 904.9, 906.9
BA15.40-N-1004-01B	Nut of belt pulley to generator	M 16x1.5 Nm 80
		M 27x1.5 Nm 150



ENGINE 904.905 /906 /907 /909 /910 /911 /915 /916 /917 /921 /922, 906.910 /911 /915 /916 /919 /920 /921 /922 /923 /925 /926 /927 /928 /939 /942 /943 /951 /952



ENGINE 904.908 /923 in MODEL 668, 670

ENGINE 906.940 /941 in MODEL 957

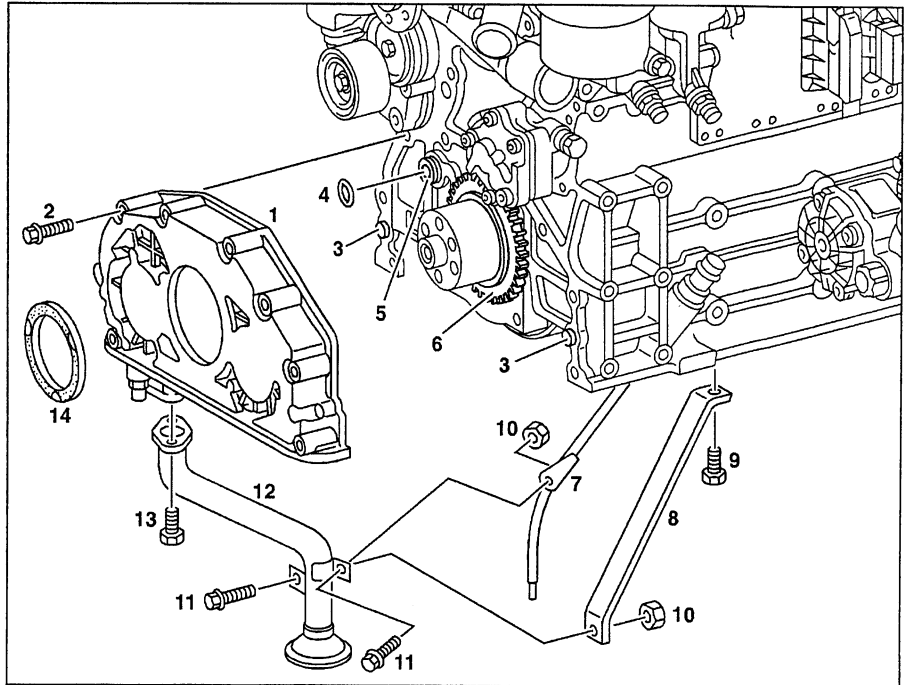
- 1 Oil pump
- 2 Bolt
- 3 Dowel pin
- 4 O-ring
- 5 Connection fitting
- 6 Drive gear
- 7 Oil dipstick guide pipe
- 8 Bracket
- 9 Bolt
- 10 Nut
- 11 Bolt
- 12 Cover the intake ports
- 13 Bolt
- 14 Radial seal



W18.10-0008-06

- 1 Oil pump
- 3 Dowel pin
- 5 Connection fitting
- 14 Radial seal
- 15  Drift
- 16  Guide sleeve
- 17 Support
- 18 Oil pump unit

A Setback of radial seal to oil pump housing

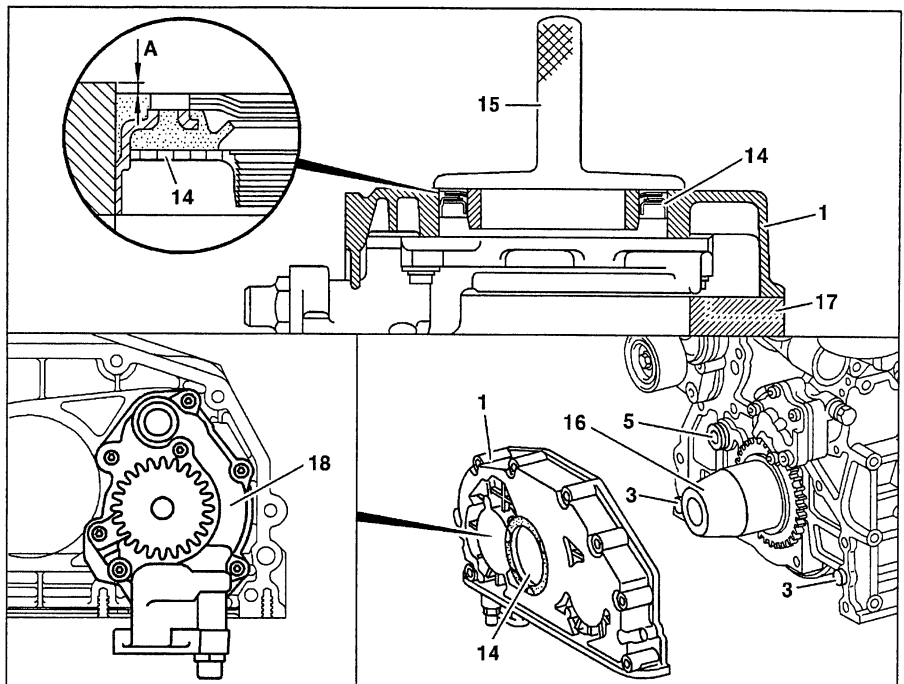











W18.10-1003-06

Modification notes

15.11.99	Inspect oil pump unit for wear.	Step 8 added	
----------	---------------------------------	--------------	--

	Removing, installing		
--	----------------------	--	--

1	Remove vibration damper	Engine 904.905- 907/909- 911/915- 917/921/922 Engine 906.910/911/915/916/919- 923/ 925- 928/939-943/951/952 Engine 904.908/923	AR03.30-W-1600A AR03.30-D-1600D
2	Remove oil pan	Engine 904.905- 907/921 Engine 904.908/923 Engine 904.909- 911/915- 917/922 Engine 906.910/911/915/916/919- 923/ 925- 928/939-943/951/952	AR01.45-W-7500A AR01.45-D-7500D AR01.45-W-7500C
3	Detach dipstick guide tube (7) and bracket (8) at the intake manifold (12)	 Installation: Attach dipstick guide tube and bracket free of stress. 	BA18.10-N-1004-01B
4	Take off intake manifold (12)		BA18.10-N-1002-01B
5	Detach oil pump (1)	 Do not damage sealing surface.  Installation: Clean contact surface at the oil pump (1) and coat with sealant. Position guide sleeve (16) on the crankshaft flange and install oil pump. Do not damage radial seal when installing.  	BR00.45-Z-1010-01A 904 589 02 15 00 BA18.10-N-1001-01B
6	Remove radial seal (14)	 Installation: Press in radial seal, axially parallel and evenly around the entire circumference. Do not damage radial seal when installing. 	904 589 02 15 00
7	Remove O-ring (4)		
8	Take off oil pump unit (18) at oil pump housing and inspect for wear	 If signs of grooves from seal and wear and tear are present at the oil pump unit or at the oil pump housing: ↓ Replace oil pump. 	BA18.10-N-1006-01B
9	Inspect front of crankshaft flange for wear		
10	Install in the reverse order		

 Timing case

Number	Designation	Engine 904.9, 906.9
BA18.10-N-1001-01B	Bolt of oil pump to crankcase	Nm 25
BA18.10-N-1002-01B	Bolt of intake manifold to oil pump	Nm 25
BA18.10-N-1004-01B	Bolt of bracket of oil pump suction pipe to crankcase	Nm 50
BA18.10-N-1006-01B	Bolt of oil pump unit to oil pump housing	Nm 12

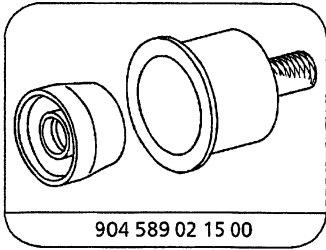

Drift

Repair products

Number	Designation	Order no.
BR00.45-Z-1010-01A	Loctite 574 sealant	001 989 89 20

ENGINE 904.905 /906 /907 /909 /910 /911 /915 /916 /917 /921 /922, 906.910 /911 /915 /916 /919 /920 /921 /922 /923 /925 /926 /927 /928 /939 /940 /941 /942 /943 /951 /952

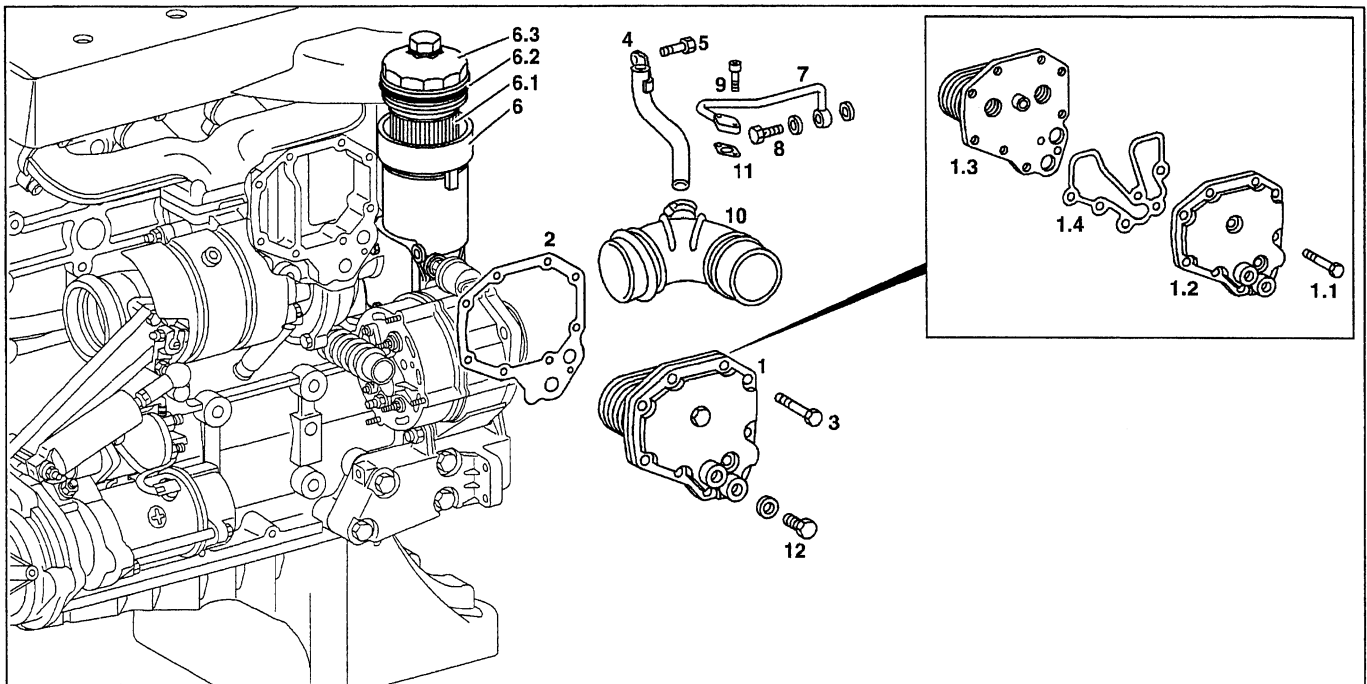



















W18.30-0003-09

- 1 Oil-water heat exchanger
- 1.1 Bolt
- 1.2 Housing cover
- 1.3 Heat exchanger
- 1.4 Gasket
- 2 Gasket
- 3 Bolt
- 4 Vent line
- 5 Bolt
- 6 Oil filter housing

- 6.1 Oil filter element
- 6.2 Seal
- 6.3 Oil filter cap
- 7 Oil pressure line
- 8 Banjo bolt
- 9 Hexagon socket bolt
- 10 Air intake hose
- 11 Gasket
- 12 Screw plug

☒ ☒	Removing, installing		
⚠ Danger!	Risk of injury from hand being jammed and bruised when tilting cab	No person must be within the tilting range of the cab when the cab is tilted. Always tilt cab as far as the end position and secure with safety prop.	Page 8
1	Tilt cab		
(i)	Notes on tilting cab	Models 375, 673-679, 950-954, 957, 970-976	Page 8
2	Remove noise encapsulation panels		
⚠ Danger!	Risk of injury to skin and eyes from scalding with hot coolant which splashes out. Risk of poisoning from swallowing coolant.	Do not open cooling system unless coolant temperature is below 90 °C. Open cap slowly and release the pressure. Do not pour coolant into beverage bottles. Wear protective gloves, protective clothing and eye protection.	Page 32
3	Drain coolant	Collect coolant Engine 904.905- 907/921	WH2080

 	Notes on coolant	Engine 904.909-911/915-917/922 Engine 906.910/911/915/916/919-923/925-928/939/940/941/942/943/951/952	AP20.00-W-2080A Page 33
4	Unscrew oil filter cap (6.3) from oil filter housing (6)	 When the oil filter cap is pulled out, the engine oil flows back into the oil pan.  	366 589 01 07 00 BA18.20-N-1003-01B
5	Remove charge air pipe	 From charge air cooler to charge air manifold	AR09.41-W-1311D
6	Remove air intake hose (10)		
7	Detach vent line (4) at connection piece		BA20.10-N-1003-01C
8	Remove vent line (4) at oil separator		
9	Detach oil pressure line (7) at oil filter housing and turbocharger	 Collect engine oil which flows out. Seal oil drilling in turbocharger. 	BA09.40-N-1002-01B
10	Drain engine oil at oil-water heat exchanger (1)	Collect engine oil.  Installation: Replace seal. 	BA18.30-N-1003-01C
11	Slacken exhaust manifold and push it away from cylinder head	 Unscrew exhaust manifold bolts about 4 mm   Installation: Inspect shank bolts, replace if necessary. Inspect gaskets for damage, if necessary: ↓ Remove exhaust manifold and replace gaskets	BA14.10-N-1001-01B BE14.10-N-1001-01A Page 3
12	Remove oil-water heat exchanger (1) at crankcase	 Collect coolant and engine oil which flows out.  	BA18.30-N-1001-01C BA18.30-N-1002-01C
13	Take off gasket (2) at oil-water heat exchanger (1)		
14	Detach housing cover (1.2) from heat exchanger (1.3)	 Installation: Do not tighten bolt (1.1) fully until after fitting oil-water heat exchanger onto crankcase.	
15	Take gasket (1.4) out of housing cover (1.2)		
16	Install in the reverse order		
	Inspect coolant level and adjust to correct level	Engine 904.905- 907/921 Engine 904.909-911/915-917/922 Engine 906.910/911/915/916/919-923/925-928/939/940/941/942/943/951/952	WH2080 AP20.00-W-2080A
18	Fill engine oil circuit		Page 48

Inspection data of exhaust manifold

Number	Designation	Engine 904.9, 906.9		
BE14.10-N-1001-01A	Exhaust manifold bolts	Thread diameter	M	10
		Shank length when new	mm	47.0
		Shank length	mm	≤47.5

Turbocharger

Number	Designation			Engine 904.9	Engine 906.9
BA09.40-N-1002-01B	Bolt of oil pressure line to turbocharger	M8	Nm	40	40
		M6	Nm	10	10

Exhaust manifold

Number	Designation	Engine 904.9, 906.9		
BA14.10-N-1001-01B	Bolt of exhaust manifold to cylinder head	1st stage	Nm	10
		2nd stage	Nm	55
		3rd stage	∠°	90

Oil filter

Number	Designation	Engine 904.9, 906.9	
BA18.20-N-1003-01B	Oil filter cap to oil filter housing	Nm	25

Oil cooling system

Number	Designation	Engine 904.9, 906.9	
BA18.30-N-1001-01C	Bolt of oil-water heat exchanger to crankcase	Nm	25
BA18.30-N-1002-01C	Bolt of housing cover to oil-water heat exchanger	Nm	25
BA18.30-N-1003-01C	Screw plug to oil-water heat exchanger	Nm	20

Coolant pump, coolant thermostat

Number	Designation	Engine 904.9, 906.9	
BA20.10-N-1003-01C	Bolt of connection piece of coolant pump to cylinder head	Nm	25

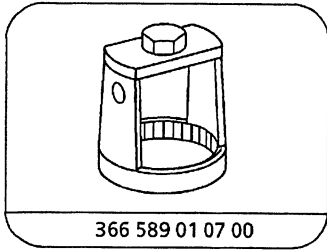

Wrench socket waf 94 mm (14-point)

AS20.00-Z-0001-01A	<p>Risk of injury to skin and eyes from scalding from hot coolant which splashes out..Risk of poisoning from swallowing coolant.</p>	<p>Do not open the cooling system unless the coolant temperature is below 90 °C. Open cap slowly and allow the pressure to release. Do not pour coolant into containers for drinks. Wear protective gloves, protective clothes, and eye protection.</p>	<p>⚠ Danger!</p>
--------------------	---	---	-------------------------

Possible dangers

Risk of injury

The cooling system is pressurized when the engine is warm. **Risk of scalding** from hot coolant which splashes out if the cooling system is opened suddenly.

Risk of poisoning

If coolant is swallowed, the person affected is likely to show signs of poisoning such as headaches, giddiness and stomach aches, paralysis of the respiratory system, unconsciousness, nausea, and convulsions.

Protective measures/rules of conduct

- Allow cooling system to cool down to a coolant temperature of less than 90 °C.
- Open coolant system cap slowly; open a conventional type of coolant system cap to the first detent and open a screw-type coolant system cap about 1/2 turn, and allow the pressure to release.
- Wear protective gloves, protective clothes, and eye protection.
- Do not pour coolant into containers for drinks.

First aid measures

- Pour large quantities of cold water over the affected area of skin and cover over with sterile bandages.
- Have person affected drink plenty of water to which medicinal carbon has been added.
- Consult a doctor if the person affected has severe burns or has swallowed considerable quantities.

AH20.00-N-2080-01A	Instructions re coolant	All engines	
--------------------	-------------------------	-------------	---

Coolant composition

Passenger car and commercial vehicle engine (normal case):

50 % by volume water and

50 % by volume anticorrosion/antifreeze agent.

See **MB Specifications for Service Products** for differing coolant composition for commercial vehicle engines.

Purposes of anticorrosion/antifreeze agent

- Corrosion and cavitation protection for all components in the cooling system
- Antifreeze protection
- Increasing boiling point so that the coolant does not evaporate so rapidly. Ejection of coolant is avoided at high coolant temperatures.

Antifreeze protection

50 % by volume of anticorrosion/antifreeze concentration offers antifreeze protection down to approx. **-37 °C**.

A higher concentration is only practical at even lower ambient temperatures.

55 % by volume of anticorrosion/antifreeze concentration offers antifreeze protection down to approx. **-45 °C**.

 Before pouring fresh coolant into the system, flush the used coolant out of the cooling system. Clean cooling system if severe soiling or oil contamination exist.

 A concentration of anticorrosion/antifreeze agent higher than 55 % by volume should not be used as the maximum antifreeze protection is thus reached. An even higher concentration again reduces the antifreeze protection and impairs heat dissipation.

Water

Use water which is clean and not too hard. Drinking water frequently, but not always, satisfies the requirements. The contents of dissolved substances in the water can be of importance for the occurrence of corrosion. In cases of doubt, analyze the water. See **MB Specifications for Service Products** for fresh water regulations.

Operation of monitoring of coolant

Inspect coolant for resistance to low temperatures before the start of the cold season of the year.

In countries with high ambient temperatures, inspect the anticorrosion/antifreeze concentration once a year.

The corrosion protection in the coolant is reduced during operation. Such coolants have a severely corrosive effect.

The maximum permissible period of use of the coolant is for passenger car and commercial vehicle engines (normal case) **3 years**.

See **MB Specifications for Service Products** for the period of use for differing coolant composition for commercial vehicle engines.

Disposing of coolants

Observe legal regulations and local wastewater regulations.

For workshops located in the Federal Republic of Germany see:

"Umweltschutz-Handbuch für Kfz-Reparaturbetriebe"
(*Environmental protection manual for vehicle repair workshops*)

Publisher: Verband der Automobilindustrie e.V. (VDA)
D-60625 Frankfurt am Main, Westendstraße 61

ENGINE 904.905 /906 /907 /909 /910 /911 /915 /916 /917 /921 /922, 906.910 /911 /915 /916 /919 /920 /921 /922 /923 /925 /926 /927 /928 /939 /940 /941 /942 /943 /951 /952





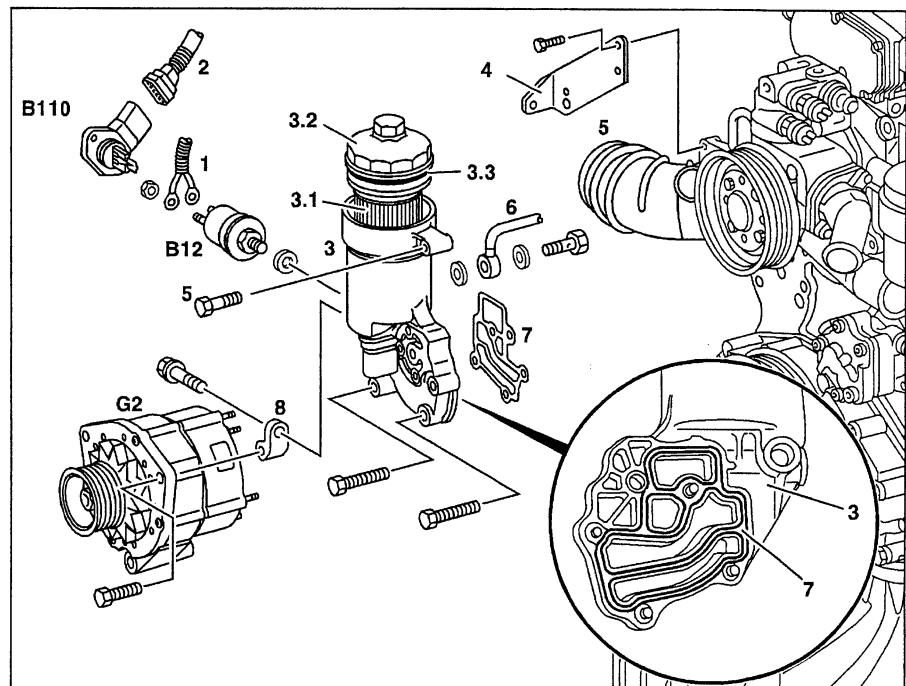







- 1 Engine wiring harness
- 2 Connector of engine wiring harness
- 3 Oil filter housing
- 3.1 Oil filter element
- 3.2 Oil filter cap
- 3.3 Seal
- 4 Bracket
- 5 Air intake hose
- 6 Oil pressure line (turbocharger)
- 7 Gasket
- 8 Bracket

- B12 Oil pressure sensor
- B110 Oil combination sensor (temperature, pressure)
- G2 Generator



W18.20-1004-06

	Removing, installing		
Danger!	Risk of explosion from explosive gas. Risk of poisoning and caustic burns from swallowing battery electrolyte. Risk of injury from caustic burns to eyes and skin from battery electrolyte or from handling damaged lead acid batteries.	No fire, sparks, naked flames or smoking. Wear acid-protective gloves, clothing and eye protection. Pour battery electrolyte only into suitable and appropriately marked containers.	Page 6
1 	Disconnect battery Notes on battery	All models	Page 7
Danger!	Risk of injury from hand being jammed and bruised when tilting cab	No person must be within the tilting range of the cab when the cab is tilted. Always tilt cab as far as the end position and secure with safety prop.	Page 8
2 	Tilt cab Notes on tilting cab	Models 375, 673- 679, 950- 954, 957, 970- 976	Page 8
3	Remove air intake hose (5)		
4	Remove charge air pipe		AR09.41-W-1311C
5	Detach bracket (4) at the coolant pump		BA20.10-N-1005-01C
6	Remove poly V-belt tensioning device		AR13.25-W-3200A
7	Unscrew oil filter cap (3.2)	When the cap is unscrewed, the engine oil flows back into the oil pan. 	366 589 01 07 00 BA18.20-N-1003-01B

8.1	Remove oil pressure sensor (B12)	Engine 904.905- 907/921  Counterhold screw plug. 	BA18.40-N-1001-01C
8.2	Unplug connector of engine wiring harness (14) at oil combination sensor (B110)	Engine 904.909- 911/915- 917/922 Engine 906.910/911/915/916/919- 923/ 925- 928/939/940/941/942/943/951/952	
9	Take off bracket (8) at oil filter housing (3)		BA15.40-N-1001-01B
10	Slacken generator (G2) and swivel bracket (8) and generator away from oil filter housing (7)		BA15.40-N-1003-01B
11	Detach oil pressure line (6) at oil filter housing (3)		
12	Pull out oil filter cap (3.2) together with oil filter element		
13	Unclip oil filter element from oil filter cap (3.2)	Inspect oil filter element for damage and soiling, if necessary: ↓ Replace oil filter element  Engine 904.905- 907/921: with modified supporting dome (integral filter bypass valve) in oil filter housing; only modified oil filter element (with central opening) may be installed.	
14	Take off oil filter housing (3) at crankcase	 	BA18.20-N-1001-01B BA18.20-N-1002-01B
15	Install in the reverse order		
16.1	Inspect engine oil level with the dipstick	Engine 904.905- 907/921	
16.2	Inspect engine oil level at the electric gage		
 AP	Request engine oil level in display	Model 950 - 957	AP18.00-W-0101-07A
 AP	Request engine oil level in display	Model 970- 976	AP18.00-W-0101-07C
 Danger!	Risk of accident from vehicle starting off by itself when engine running. Risk of injury from bruises and burns if you hold your hand into engine when it is started or when it is running.	Secure vehicle to prevent it moving off by itself. Wear closed and close-fitting work clothes. Do not grasp hot or rotating parts.	Page 9
17	Start engine	 Do not rev up engine so long as no oil pressure is indicated.  The oil pressure gage must indicate oil pressure after about 10 seconds	BE18.00-N-1001-01C
18	Switch off engine and inspect for leaks	 Visual inspection	

Test data of engine oil pressure

Number	Designation	Engine 904.9, 906.9
BE18.00-N-1001-01C	Engine oil pressure at	Idle speed bar ≥ 0.5
		Maximum speed bar ≥ 2.5

Nm Generator

Number	Designation	Engine 904.9, 906.9
BA15.40-N-1001-01B	Bolt of generator bracket to oil filter Nm	40
BA15.40-N-1003-01B	Bolt of generator to bracket Nm	65

Nm Oil filter

Number	Designation	Engine 904.9, 906.9
BA18.20-N-1001-01B	Bolt of oil filter housing to crankcase Nm	25
BA18.20-N-1002-01B	Bolt of support of oil filter housing to crankcase Nm	25
BA18.20-N-1003-01B	Oil filter cap to oil filter housing Nm	25

Nm Oil level/oil pressure sensor

Number	Designation	Engine 904.9, 906.9
BA18.40-N-1001-01C	Oil pressure sensor to oil filter housing Nm	25

Nm Coolant pump, coolant thermostat

Number	Designation	Engine 904.9, 906.9
BA20.10-N-1005-01C	Bracket to coolant pump Nm	50

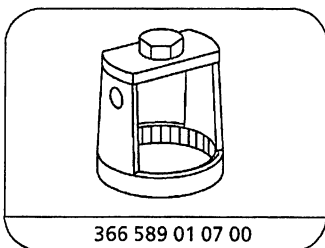

366 589 01 07 00

Wrench socket waf 94 mm (14-point)



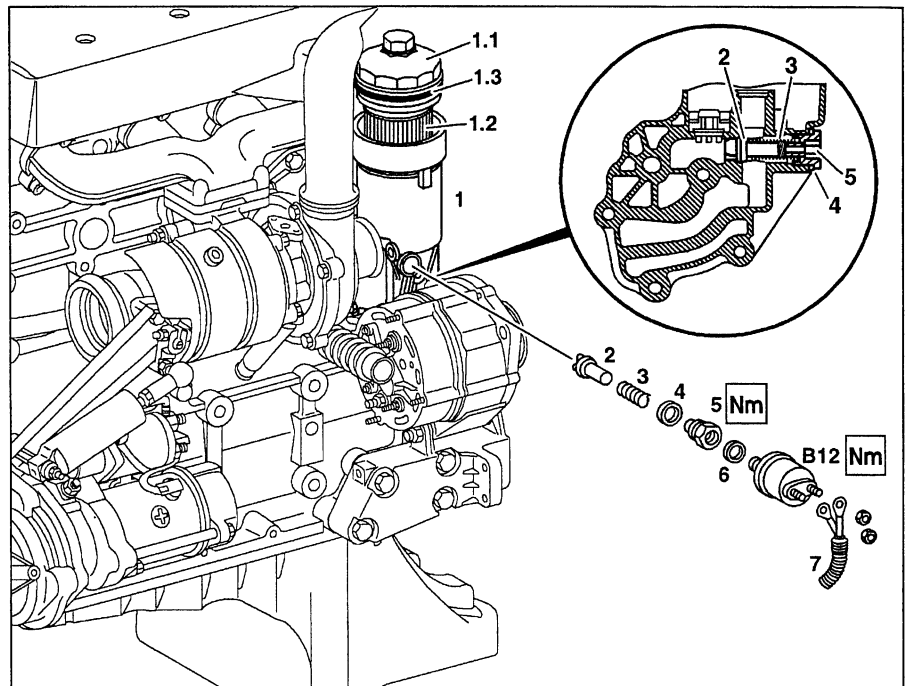

ENGINE 904.905 /906 /907 /921 ## up to 16109
ENGINE 904.908 ## up to 16109 in MODEL 668, 670

- 1 Oil filter housing
 - 1.1 Oil filter cap
 - 1.2 Oil filter element
 - 1.3 Seal
 - 2 Oil filter bypass valve
 - 3 Spring
 - 4 Seal
 - 5 Screw plug
 - 6 Seal
 - 7 Engine wiring harness
- B12 Oil pressure sensor



W18.20-0002-06

	Removing, Installing		
Danger!	Risk of injury from bruises and jamming when tilting cap	No person should be in the tilting area of the cab when it is being tilted. Always tilt cab as far as the end position and secure with a safety prop.	Page 8
1.1	Tilt cab	Model 673 - 679	
	Notes re tilting cab		Page 8
1.2	Remove service cover	Model 668, 670	
2.1	Remove noise encapsulation on right	Engine 904.905- 907/921	
2.2	Remove air intake hose	Engine 904.908	AR09.10-D-8030D
3	Unscrew oil filter cap (1.1) from oil filter housing (1)	<p> When oil filter cap is unscrewed, the engine oil flows back into the oil pan</p> <p></p> <p> Installing: inspect seal (1.3) at oil filter cap and replace if necessary.</p> <p>Replace seal (1.3).</p> <p></p> <p> Oil filter cap to oil filter housing</p>	<p>366 589 01 07 00</p> <p>366 589 01 07 00</p> <p>BA18.20-N-1003-01B</p>
5	Remove screw plug (5)	<p> The screw plug is pressed out by the spring (3).</p> <p> Installation: replace seal (4).</p> <p> Screw plug of oil filter bypass valve to oil filter housing</p>	BA18.20-N-1004-01B

6	Take out spring (3) and oil filter bypass valve (2) and inspect for damage	 Installing: check that oil filter bypass valve is correctly located in oil filter housing (1); install spring for this purpose. When installed, spring should project about 1 cm at oil filter housing.	
7	Install in the reverse order		
8	Adjust engine oil to the correct level	Engine 904.905- 907/921 Engine 904.908	WH0101.40 AP18.00-D-0101A
 Danger!	Risk of accident as a result of vehicle starting off when engine running. Risk of injury as a result of bruises and burns if you insert your hands into engine when it is being started or when it is running	Secure vehicle to prevent it moving off. Wear closed and close-fitting work clothes. Do not grasp hot or rotating parts.	Page 9
9	Start engine and check oil pressure gauge with engine idling	 Crank engine with the starter for not more than 20 seconds. Wait approx. 2 minutes before making a repeat attempt at starting. Do not rev up engine so long as no oil pressure is indicated.  The oil pressure gage should indicate oil pressure after approx. 10 seconds.	BE18.00-N-1001-01C
11	Switch off engine and check for leaks		

Test data of engine oil pressure

Number	Designation	Engine 904.9, 906.9
BE18.00-N-1001-01C	Engine oil pressure at idling speed	bar $\geq 0,5$
	maximum speed	bar $\geq 2,5$

Oil filter

Number	Designation	Engine 904.9, 906.9
BA18.20-N-1003-01B	Oil filter cap to oil filter housing	Nm 25
BA18.20-N-1004-01B	Oil filter bypass valve screw plug to oil filter housing	Nm 50

Oil level sensor, oil pressure sensor

Number	Designation	Engine 904.9, 906.9
BA18.40-N-1001-01C	Oil pressure sensor to oil filter housing	Nm 25

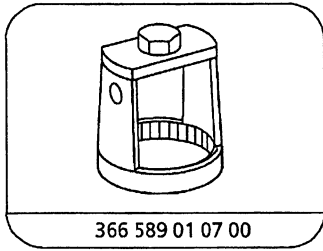

366 589 01 07 00

Wrench insert waf 94 mm (14-point)

ENGINE 904.905 /906 /907 /908 /921 ## as of 040488

ENGINE 904.915 /916 /917 /909 /910 /911 /922 /923, 906.910 /911 /915 /916 /919 /920 /921 /922 /923 /925 /926 /927 /928 /939 /940 /941 /942 /943 /951 /952



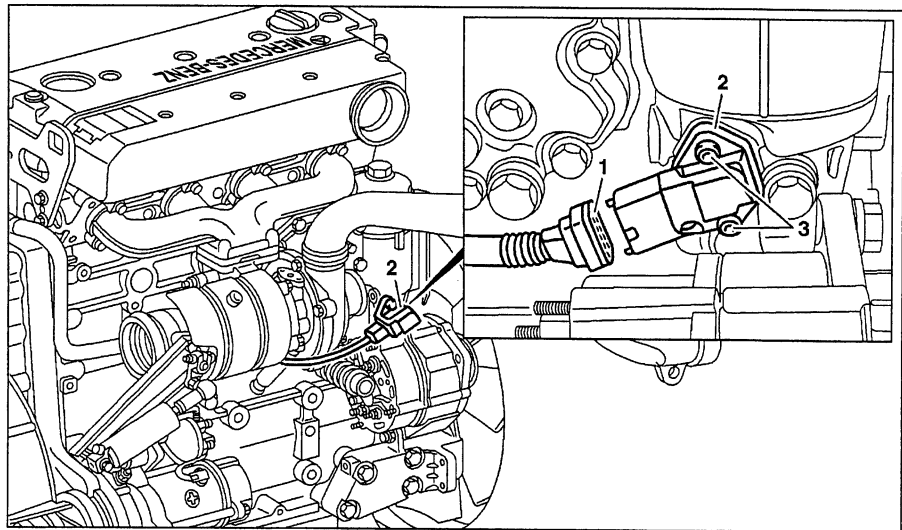







- 1 Connector of engine wiring harness
- 2 Oil combination sensor (temperature, pressure) (B110)
- 3 Bolt



W18.40-0003-05

Modification notes

13.3.00	Inspecting engine oil level	Steps 7.1 and 7.2 added	AP18.00-W-0101-07A AP18.00-W-0101-07C
---------	-----------------------------	-------------------------	--

	Removing, installing		
 Danger!	Risk of injury from hand being jammed and bruised when tilting cab	No person must be within the tilting range of the cab when the cab is tilted. Always tilt cab as far as the end position and secure with safety prop.	Page 8
1.1 	Tilt cab Notes on tilting cab	Models 375, 673- 679, 950- 954, 957, 970- 976	Page 8
1.2	Remove service cover	Models 668, 670	
2	Remove noise encapsulation on right		
3	Remove air intake hose		
4	Unscrew oil filter cap from oil filter housing	 When the oil filter cap is unscrewed, the engine oil flows back into the oil pan.   Installation: Inspect seal at oil filter cap, replace if necessary. 	366 589 01 07 00 BA18.20-N-1003-01B
5	Remove oil combination sensor (2)		BA18.40-N-1003-01C
6	Install in the reverse order		
7.1	Inspect engine oil level with the dipstick	Engine 904.905- 907/921	
7.2	Inspect engine oil level at the electric gage		
 AP	Request engine oil level in display	Model 950 - 957	AP18.00-W-0101-07A
 AP	Request engine oil level in display	Model 970- 976	AP18.00-W-0101-07C

⚠ Danger!	<p>Risk of accident from vehicle starting off by itself when engine running. Risk of injury from bruises and burns if you hold your hand into engine when it is started or when it is running.</p> <p>Start engine</p>	<p>Secure vehicle to prevent it moving off by itself. Wear closed and close-fitting work clothes. Do not grasp hot or rotating parts.</p> <p>ⓘ Do not rev up engine so long as no oil pressure is indicated.</p> <p>ⓘ The oil pressure gage must indicate oil pressure after about 10 seconds</p>	BE18.00-N-1001-01C
8			
9	Switch off engine and inspect for leaks		

Test data of engine oil pressure

Number	Designation	Engine 904.9, 906.9
BE18.00-N-1001-01C	Engine oil pressure at	
	Idle speed	bar ≥ 0.5
	Maximum speed	bar ≥ 2.5

Nm Oil filter

Number	Designation	Engine 904.9, 906.9
BA18.20-N-1003-01B	Oil filter cap to oil filter housing	Nm 25

Nm Oil level/oil pressure sensor

Number	Designation	Engine 904.9, 906.9
BA18.40-N-1003-01C	Bolt of combination sensor for oil pressure and oil temperature to oil filter housing	Nm 8

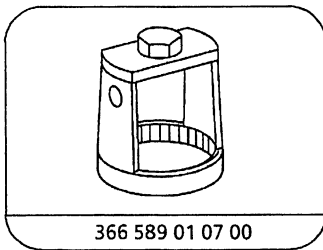

Wrench socket waf 94 mm (14-point)

ENGINE 904.909 /910 /911 /915 /916 /917 /922, 906.910 /911 /915 /916 /919 /920 /921 /922 /923 /925 /926 /927 /928 /939 /940 /941 /951 /952 /942 /943

- 1 Oil pan
2 Clip
3 Engine wiring harness
4 Seal

B14 Engine oil level sensor

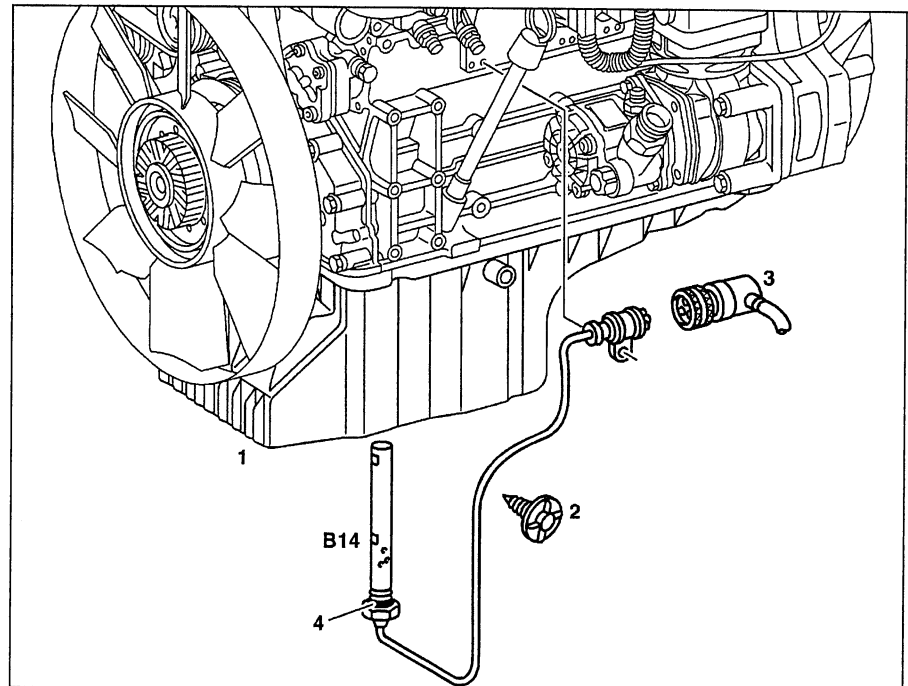

W18.40-0001-06

	Removing, installing		
1 AP	Extract or drain engine oil		AP18.00-W-0101B
2	Separate connector of engine oil level sensor (B14) at engine wiring harness (3)		
3	Disconnect electric cable of engine oil level sensor (B14) at oil pan (1)		
4	Remove oil level sensor (B14) at oil pan (1)	Inspect seal (4), replace if necessary. 	WH58.30-Z-1037-06A BA18.40-N-1002-01C
5	Install in the reverse order		
6.1	Check engine oil level with dipstick	Engine 904.905- 907/921	
6.2 AP AP Danger!	Inspect engine oil level at the electric gage Request engine oil level in display Request engine oil level in display Risk of accident from vehicle starting off by itself when engine running. Risk of injury from bruises and burns if you hold your hand into engine when it is started or when it is running.	Model 950 - 957 Model 970- 976 Secure vehicle to prevent it moving off by itself. Wear closed and close-fitting work clothes. Do not grasp hot or rotating parts.	AP18.00-W-0101-07A AP18.00-W-0101-07C Page 9

7	Start engine and observe oil pressure gage at idle speed	⊛ Crank engine with starter for not more than 90 s. Wait about 2 minutes at least before repeating start operation. Motor nicht hochdrehen solange noch kein Öldruck angezeigt wird. i The oil pressure gage must indicate oil pressure after about 10 s.	BE18.00-N-1001-01C
8	Switch off engine and inspect for leaks		

Test data of engine oil pressure

Number	Designation	Engine 904.9, 906.9
BE18.00-N-1001-01C	Engine oil pressure at	
	Idle speed	bar ≥ 0.5
	Maximum speed	bar ≥ 2.5

Nm Oil level/oil pressure sensor

Number	Designation	Engine 904.9, 906.9
BA18.40-N-1002-01C	Oil level sensor to oil pan	Nm 50

Commercially available tools (see Workshop Equipment Manual)

Number	Designation	Make (e. g.)	Order no.
WH58.30-Z-1037-06A	Special socket (waf 27)	Make Friweg Stormsweg 12 D-22085 Hamburg	493 45850

ENGINE 904.908 /923 in MODEL 668, 670

ENGINE 904.905 /906 /907 /909 /910 /911 /921 /922 ## up to 066192

ENGINE 906.910 /911 /920 /921 /922 /923 ## up to 067198

ENGINE 906.940 /941 ## up to 067198 in MODEL 957

- 1 Oil spray nozzle
2 Banjo bolt

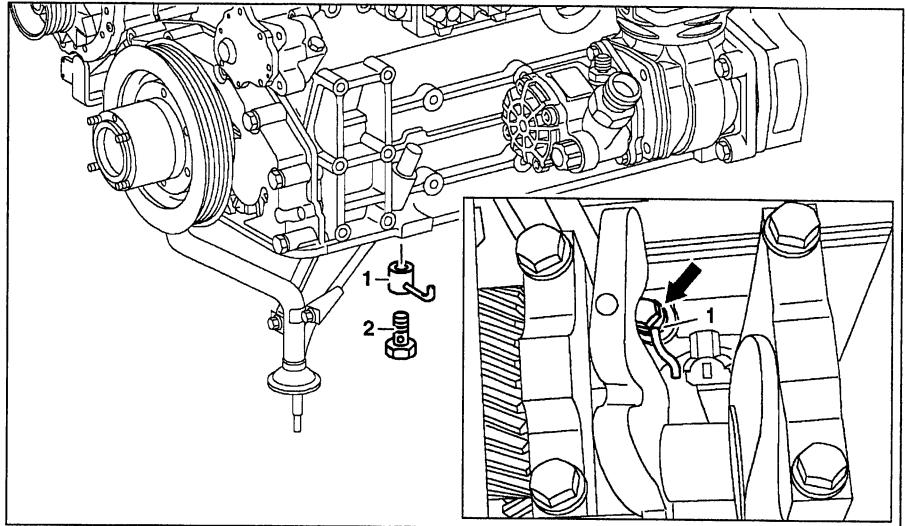

W18.00-0002-05

Icon	Removing, installing		
1	Remove oil pan	Engine 904.905- 907/921 Engine 904.908/923 Engine 904.909- 911/922 and 906.910/911/920- 923	AR01.45-W-7500A AR01.45-D-7500D AR01.45-W-7500C
2	Take off cover at timing case	Nm	BA01.60-N-1002-01A
3	Rotate crankshaft until the oil spray nozzle (1) to be removed, is accessible		
4	Fit on cranking and blocking device (3) at timing case	i Block cranking and blocking device by inserting the pin. G Nm	Page 45 904 589 04 63 00 BA01.60-N-1002-01A
5	Remove oil spray nozzle (1)	i Installation: The dowel pin at the oil spray nozzle must engage in the hole in the crankcase (arrow)).	
6	Inspect oil spray nozzle (1)	If damage present, replace oil spray nozzle	
7	Install in the reverse order		

Nm Timing case

Number	Designation	Engine 904.9, 906.9
BA01.60-N-1002-01A	End cover of inspection hole to timing case	Nm 25

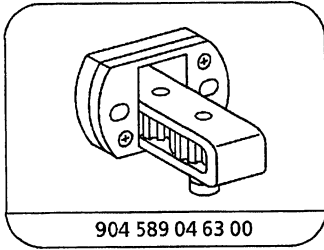

904 589 04 63 00

Cranking device

AR03.30-W-1600-03A	Attaching, detaching cranking/blocking device for engine		
--------------------	--	--	--

Nm Timing case

Number	Designation	Engine	
		904.9, 906.9	
BA01.60-N-1002-01A	End cover of inspection hole to timing case	Nm	25

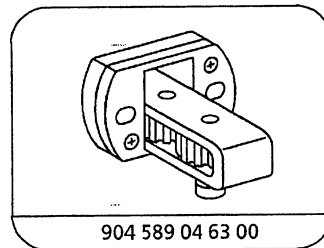

904 589 04 63 00

Cranking device

- 1 Remove noise encapsulation below flywheel housing.
- 2 Remove cover (1) at flywheel housing (if fitted).
- 3 Attach cranking and blocking device (2) tight to flywheel housing with bolts (4).
- Cranking and blocking device (2) can be blocked by inserting the pin (3).
- Cranking and blocking device (2) must be removed before starting the engine.

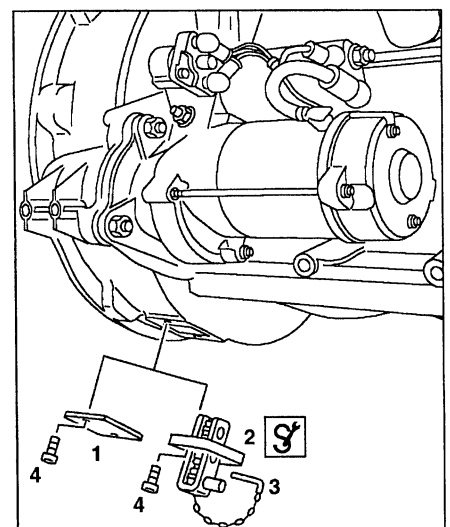



W03.30-0001-02

ENGINE 904.909 /910 /911 /922 ## as of 066193







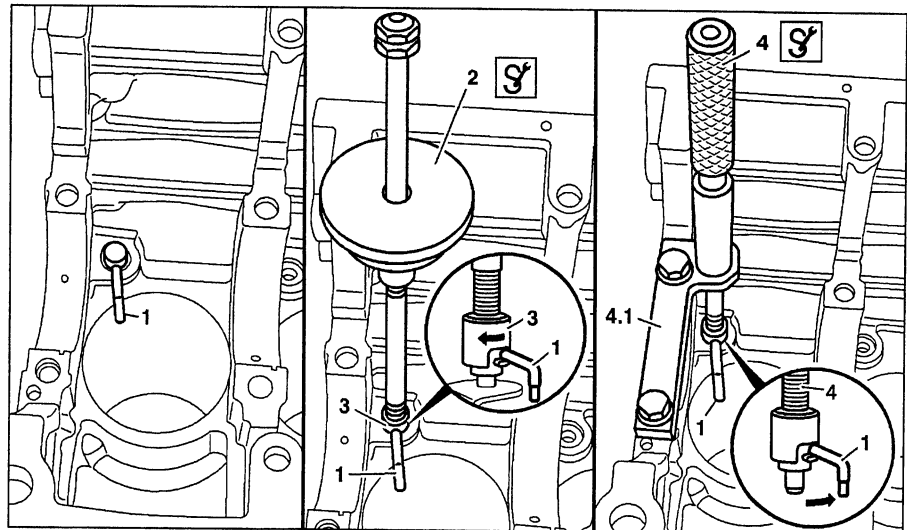



ENGINE 906.910 /911 /920 /921 /922 /923 /940 /941 ## as of 067199

ENGINE 904.915 /916 /917, 906.915 /916 /925 /926 /927 /928 /939 /942 /943 /951 /952

- 1 Oil spray nozzle
 2  Impact extractor
 3  Extraction tool
 4  Insertion tool



W18.00-1004-05

	Removing		
1	Remove crankshaft		AR03.20-W-4351A
2	Screw together impact extractor (2) and extraction tool (3)	 	906 589 00 43 00 355 589 01 63 00
3	Knock out oil spray nozzle (1)	 Fit on extraction tool (3) at the oil spray nozzle.  Spray pipe of the oil spray nozzle must be inserted into the guide slot of the extraction claw as far as a stop.	
4	Clean oil feed drilling in crankcase		
	Installing		
5	Clamp oil spray nozzle (1) in the insertion tool (4)	 Replace oil spray nozzle. Turn spray pipe in the guide slot as far as the stop. 	906 589 00 43 00
6	Install oil spray nozzle (1)	 Screw insertion tool (4) and bracket (4.1) tight at the holes of the main bearing cap. The oil spray nozzle must be positioned vertically to the crankcase contact surface.  Knock in oil spray nozzle as far as a stop.	
7	Install crankshaft		AR03.20-W-4351A

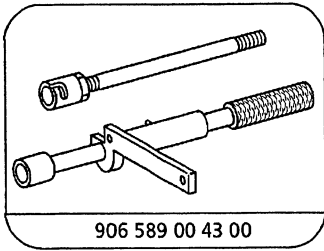

906 589 00 43 00

Insertion and extraction tool

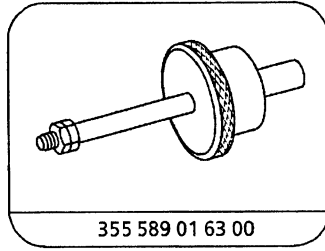



355 589 01 63 00

Impact extractor

ENGINE 904.905 /906 /907 /909 /910 /911 /915 /916 /917 /921 /922, 906.910 /911 /915 /916 /919 /920 /921 /922 /923 /925 /926 /927 /928 /939 /942 /943







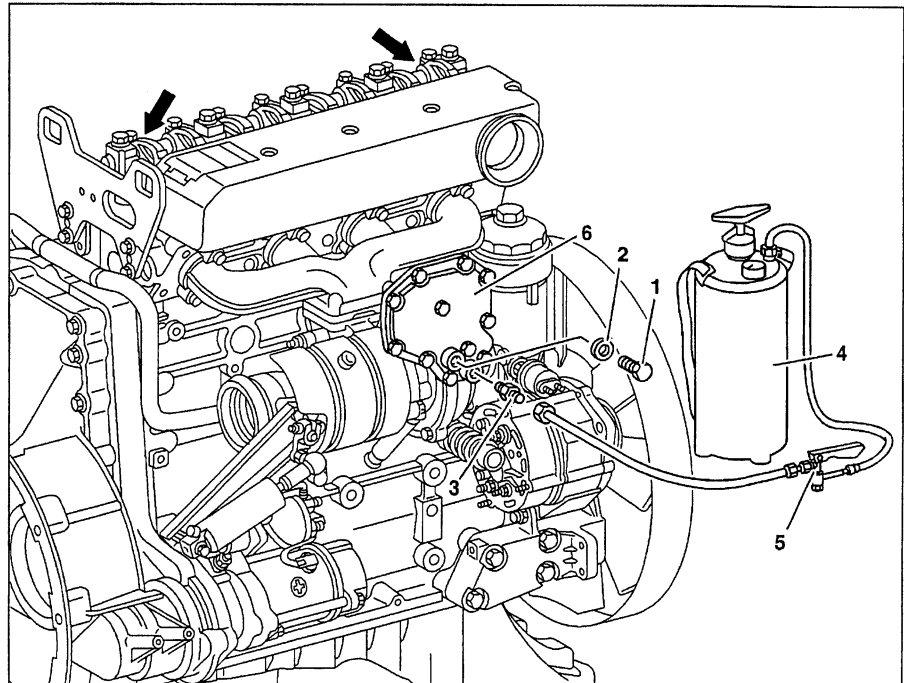

ENGINE 904.908 /923 in MODEL 668, 670

ENGINE 906.940 /941 /951 /952 in MODEL 957

- 1 Screw plug
- 2 Seal
- 3  Pipe union (M14×1.5)
- 4  Oil filling reservoir
- 5  Shutoff valve
- 6 Oil-water heat exchanger



W18.00-0005-06

	Removing, installing		
1	Remove cylinder head cover		AR01.20-W-5014A
2.1	Remove noise encapsulation on right	Engine 904.905-907/909-911/915-917/921/922 Engine 906.910/911/915/916/919-923/ 925-928/939/940/941/951/952	
2.2	Remove air intake hose	Engine 904.908/923	AR09.10-D-8030D
3	Remove screw plug (1) at oil-water heat exchanger (6)	 Installation: Replace seal (2). 	BA18.30-N-1003-01C
4	Screw pipe union (3) tight	 Use pipe union (M14×1.5).	352 589 11 63 00
5	Screw connection hose from oil filling reservoir (4) tight at pipe union (3)		352 589 11 63 00
	Filling		
6	Fill oil filling reservoir (4) with 5 l of approved engine oil and seal		352 589 11 63 00
7	Use the integral hand pump to produce a pressure of about 3 bar	 Shutoff valve (5) closed.	
8	Open shutoff valve (5) long enough until about 4.0 l of engine oil has been pumped from the oil filling reservoir (4) into the oil galleries and the engine oil flows out free of bubbles at the rocker arms (arrows)	 The pressure in the oil filling reservoir must not drop below 1.5 bar; operate pump, if necessary. Do not empty oil filling reservoir completely otherwise air will be forced in. 	352 589 11 63 00

9	Install in the reverse order		
10	Top up remaining engine oil at the filler neck	Engine 904.905- 907/921 Engine 904.908/923 Engine 904.909-911/915-917/922 Engine 906.910/911/915/916/919-923/ 925-928/939/940/941/942/943/951/952	WH0101.40 AP18.00-D-0101A AP18.00-W-0101B
11.1	Check engine oil level with dipstick	Engine 904.905- 907/921 Engine 904.908/923	AP18.00-D-0101A
11.2	Inspect engine oil level at the electric gage Request engine oil level in display Request engine oil level in display	Model 950 - 957 Model 970- 976	AP18.00-W-0101-07A AP18.00-W-0101-07C
12	⚠ Danger! Risk of accident from vehicle starting off by itself when engine running. Risk of injury from bruises and burns if you hold your hand into engine when it is started or when it is running. Start engine and observe oil pressure gage at idle speed	Secure vehicle to prevent it moving off by itself. Wear closed and close-fitting work clothes. Do not grasp hot or rotating parts. ⌚ Crank engine with starter for not more than 90 s. Wait about 2 minutes at least before repeating start operation. Motor nicht hochdrehen solange noch kein Öldruck angezeigt wird. i The oil pressure gage must indicate oil pressure after about 10 s.	Page 9 BE18.00-N-1001-01C
13	Switch off engine and inspect for leaks		

Test data of engine oil pressure

Number	Designation	Engine 904.9, 906.9
BE18.00-N-1001-01C	Engine oil pressure at	
	Idle speed	bar ≥ 0.5
	Maximum speed	bar ≥ 2.5

Nm Oil cooling system

Number	Designation	Engine 904.9, 906.9
BA18.30-N-1003-01C	Screw plug to oil-water heat exchanger	Nm 20

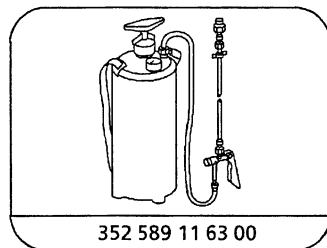



Oil filling reservoir

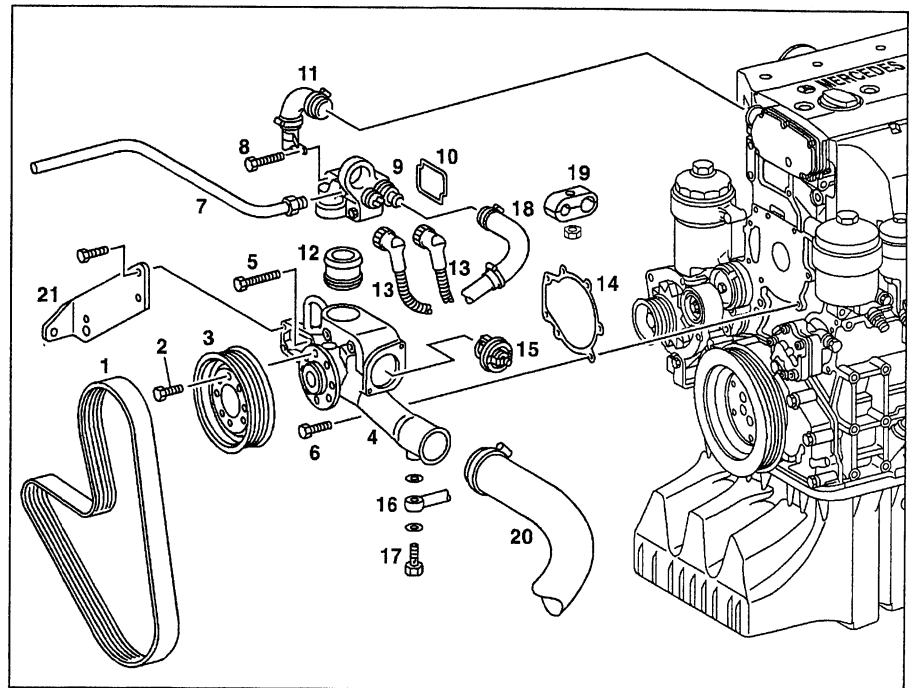

ENGINE 904.905 /906 /907 /909 /910 /911 /915 /916 /917 /921 /922, 906.910 /911 /915 /916 /919 /920 /921 /922 /923 /925 /926 /927 /928 /939 /940 /941 /942 /943 /951 /952

- 1 Poly V-belt
- 2 Bolt
- 3 Belt pulley
- 4 Coolant pump
- 5 Bolt M8×90
- 6 Bolt M8×45
- 7 Coolant line
- 8 Bolt
- 9 Connection piece
- 10 Gasket
- 11 Crankcase ventilation
- 12 Connection fitting
- 13 Connector of engine wiring harness
- 14 Gasket
- 15 Coolant thermostat
- 16 Coolant line
- 17 Banjo bolt
- 18 Coolant line
- 19 Bracket
- 20 Coolant hose
- 21 Bracket



W20.10-0013-06

	Removing, installing		
 Danger!	Risk of injury from hand being jammed and bruised when tilting cab	No person must be within the tilting range of the cab when the cab is tilted. Always tilt cab as far as the end position and secure with safety prop.	Page 8
1	Tilt cab		Page 8
	Notes on tilting cab	Models 375, 673-679, 950-954, 957, 970-976	Page 8
2	Remove noise encapsulation panels		
3	Remove coolant thermostat (15)		Page 55
4	Slacken bolts at the belt pulley (3)		
5	Slacken poly V-belt (1) and take off		AR13.22-W-1202A
6	Remove belt pulley (3)	Nm	BA20.10-N-1002-01C
7.1	Remove bracket (19) at charge air manifold or at charge air pipe	Engine 904.905- 907/921	
7.2	Remove bracket (21) at charge air pipe and at coolant pump (4)	Engine 904.909-911/915-917/922 Engine 906.910/911/915/916/919-923/925-928/939/940/941/942/943/951/952 Nm	BA20.10-N-1005-01C
8	Separate connector of engine wiring harness (13) at coolant temperature sensors		
9	Remove connection piece (9)	Nm	Page 51 BA20.10-N-1003-01C

10	Remove connection fitting (12)	 Installation: Replace connection fitting.	
11	Detach coolant hose (20) and coolant line (16) at the coolant pump (4)	Collect coolant which flows out.	
12	Remove coolant pump (4) and take off gasket (14)		BA20.10-N-1001-01C
13	Clean sealing surfaces at crankcase and at coolant pump (4)		
14	Install in the reverse order		
15	Inspect coolant level and inspect cooling system for leaks	Engine 904.905- 907/921 Engine 904.909-911/915-917/922 Engine 906.910/911/915/916/919-923/ 925-928/939/940/941/942/943/951/952	WH2080 AP20.00-W-2080A



 Coolant pump, coolant thermostat

Number	Designation	Engine 904.9, 906.9	
BA20.10-N-1001-01C	Bolt of coolant pump to crankcase	Nm	25
BA20.10-N-1002-01C	Bolt of belt pulley to coolant pump	Nm	25
BA20.10-N-1003-01C	Bolt of connection piece of coolant pump to cylinder head	Nm	25
BA20.10-N-1005-01C	Bracket to coolant pump	Nm	50

AR20.10-W-1290-02A	Removing, installing connection piece of coolant pump to cylinder head		
--------------------	--	--	--

 Coolant pump, coolant thermostat

Number	Designation	Engine 904.9, 906.9	
BA20.10-N-1003-01C	Bolt of connection piece of coolant pump to cylinder head	Nm	25

- 1 Disconnect coolant lines (1, 2) at connection piece (3).
- 2 Unscrew bolts (4) and take off crankcase ventilation line (5).
- 3 Pull connection piece (3) up and out of connection fitting (6).
- 4 Replace gasket (7) and connection fitting (6).

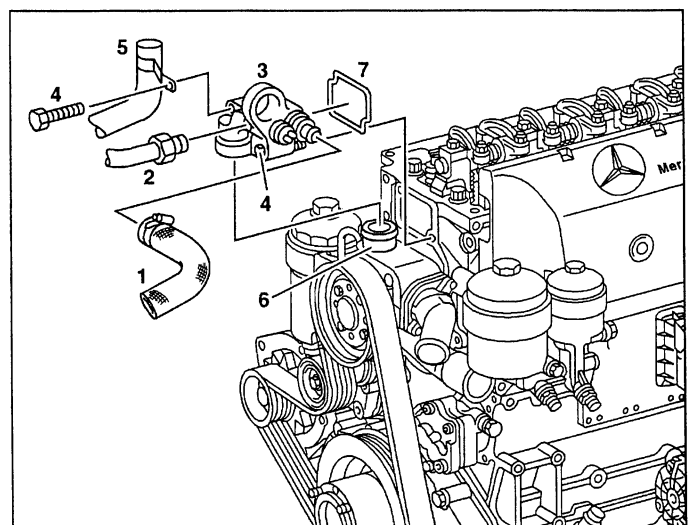



W20.10-0014-11

ENGINE 904.905 /906 /907 /909 /910 /911 /915 /916 /917 /921 /922, 906.910 /911 /915 /916 /919 /920 /921 /922 /923 /925 /926 /927 /928 /939 /942 /943

ENGINE 904.908 /923 in MODEL 668, 670

ENGINE 906.940 /941 /951 /952 in MODEL 957

- 1 Flange
- 2 Circlip
- 3 Bearing shaft
- 4 Coolant pump housing
- 5 Cassette-type seal
- 6 Impeller
- 7  Puller
- 8  Thrust piece

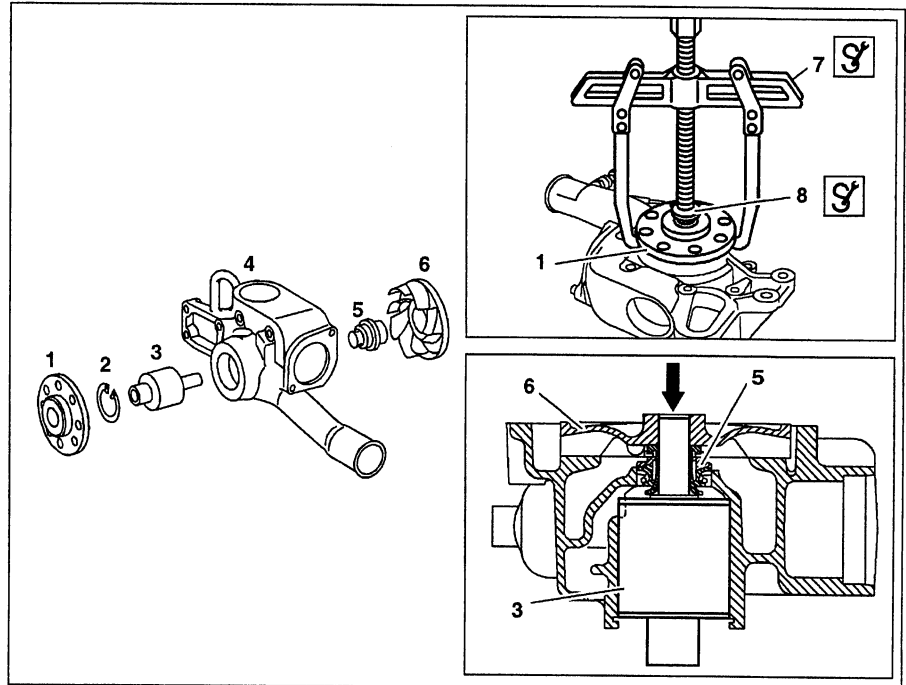

W20.10-0003-06

- 1 Flange
 - 2 Circlip
 - 3 Bearing shaft
 - 5 Cassette-type seal
 - 6 Impeller
 - 9  Drift
- A Gap between impeller and coolant pump housing
- B Distance between coolant pump housing and flange
- C Projection of impeller to coolant pump housing

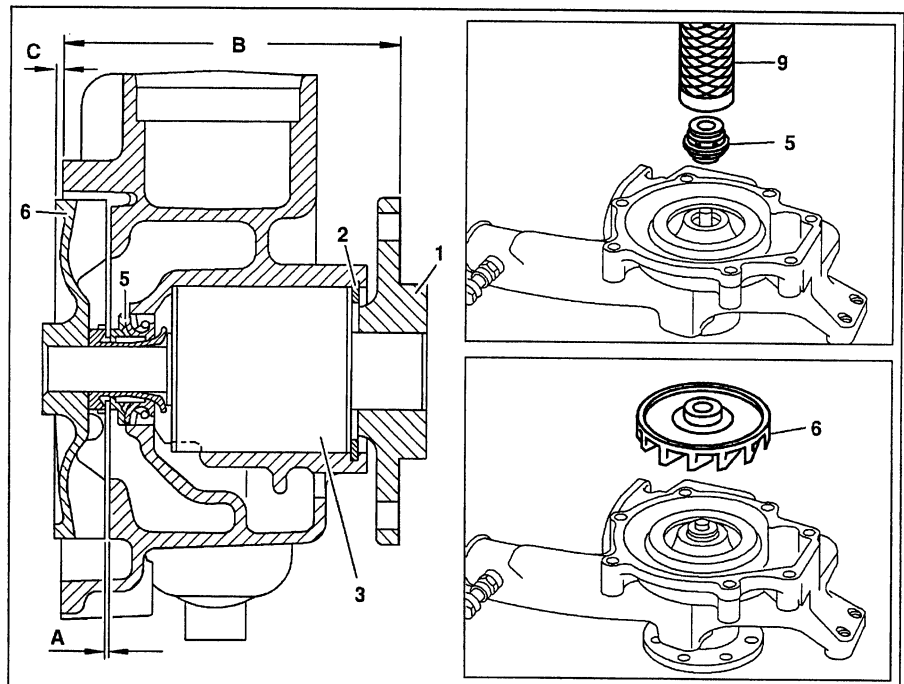











W20.10-0016-06

Modification notes

15.11.99	The bearing shaft of the coolant pump must always be replaced	Step 6	
----------	---	--------	--

	Disassembling		
--	---------------	--	--

1	Remove coolant pump	Engine 904.905- 907/909- 911/915- 917/921/922 Engine 906.910/911/915/916/919- 923/ 925- 928/939-943/951/952 Engine 904.908/923	Page 50 AR20.10-D-1271D
2	Pull flange (1) off the bearing shaft (3)	 	000 589 65 33 00 321 589 00 63 00
3	Remove circlip (2)		
4	Use a suitable drift to press bearing shaft (3) out of the impeller (6) and the coolant pump housing (4)		WE58.40-Z-1001-12A
5	Remove cassette-type seal (5)		
	Assembling		
6	Oil bearing shaft (3) at bearing outer race with engine oil and press into coolant pump housing (4) with a suitable drift	 The bearing shaft must always be replaced. Press in bearing shaft only at the bearing outer race. 	WE58.40-Z-1001-12A
7	Install circlip (2)		
 Danger!	Risk of injury to skin and eyes from handling hot or glowing objects.	Wear protective gloves, protective clothes and, if necessary, eye protection.	Page 54
8	Heat flange (1) and press onto bearing shaft (3)	 When pressing on, counterhold at the shaft. Measure dimension (B) distance between coolant pump housing (4) and flange (contact surface of belt pulley). 	BE20.10-N-1002-01B WE58.40-Z-1001-12A
9	Fit new cassette-type seal (5) over the bearing shaft (3) and use a drift to press it in as far as the coolant pump housing (4)	  Inspect seat of cassette-type seal on the bearing shaft and in the coolant pump housing.	352 589 08 15 00
10	Press impeller (6) onto bearing shaft (3)	 When pressing on, counterhold at the shaft. Measure projection dimension (C) of impeller to coolant pump housing (4). Measure gap (A) between impelle and coolant pump housing (4). 	BE20.10-N-1003-01B BE20.10-N-1001-01B WH58.30-Z-1008-12A
11	Rotate coolant pump at flange (1) and inspect for smooth running		
12	Install coolant pump	Engine 904.905- 907/909- 911/915- 917/921/922 Engine 906.910/911/915/916/919- 923/ 925- 928/939-943/951/952 Engine 904.908/923	Page 50 AR20.10-D-1271D

Inspection data of coolant pump

Number	Designation	Engine 904.9, 906.9
BE20.10-N-1001-01B	Gap between impeller and coolant pump housing (A)	mm 0.6-1.0
		See figure -
BE20.10-N-1002-01B	Distance between coolant pump housing and flange (B)	mm 112.7-113.3
		See figure -
BE20.10-N-1003-01B	Projection between coolant pump housing (C)	mm ≤ 0.5
		See figure -

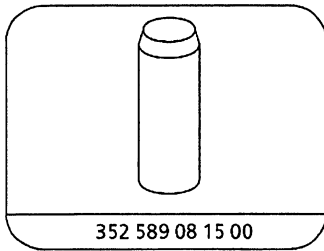

352 589 08 15 00

Drift

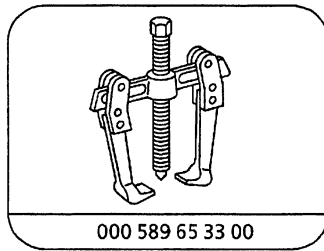

000 589 65 33 00

Puller

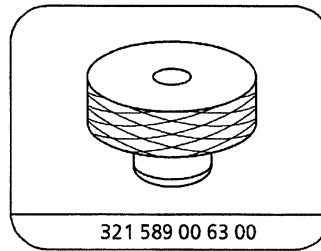

321 589 00 63 00

Thrust piece

Commercially available tools (see Workshop Equipment Manual)

Number	Designation	Make (e. g.)	Order no.
WH58.30-Z-1008-12A	Feeler gauge	Stiefelmayer D-73734 Esslingen	59

Workshop equipment/MB testers (see Workshop Equipment Manual)

WE58.40-Z-1001-12A	Stationary workshop press 65 t, e.g. Matra-Werke GmbH, D-60314 Frankfurt/Main
--------------------	---

AS00.00-Z-0002-01A	Risk of injury to skin and eyes from handling hot or glowing objects	Wear protective gloves, protective clothing and, if appropriate, eye protection.	Danger!
--------------------	--	--	----------------

Risk of injury

Contact with hot or glowing objects without suitable protective clothing causes severe burns to the skin and eyes.

Contact between glowing objects and water produces hot water vapor or splashes which can cause severe burns to skin and eyes. If hot or glowing objects come into contact with unprotected skin or eyes, this can cause severe and even permanent injury.

Contact between glowing objects and combustible substances produces a risk of fire.

Protective measures/rules of conduct

- Wear protective clothing, eye protection, heat-resistant gloves.
- Transport hot or glowing objects only with the aids and equipment provided for this purpose.
- Avoid sparks and contact with combustible substances when handling glowing objects.

First-aid measures

- Pour plenty of cold water over the affected areas of skin and cover with sterile bandages.
- Consult a doctor without delay.

ENGINE 904.905 /906 /907 /909 /910 /911 /915 /916 /917 /921 /922, 906.910 /911 /915 /916 /919 /920 /921 /922 /923 /925 /926 /927 /928 /939 /942 /943

ENGINE 904.908 /923 in MODEL 668, 670

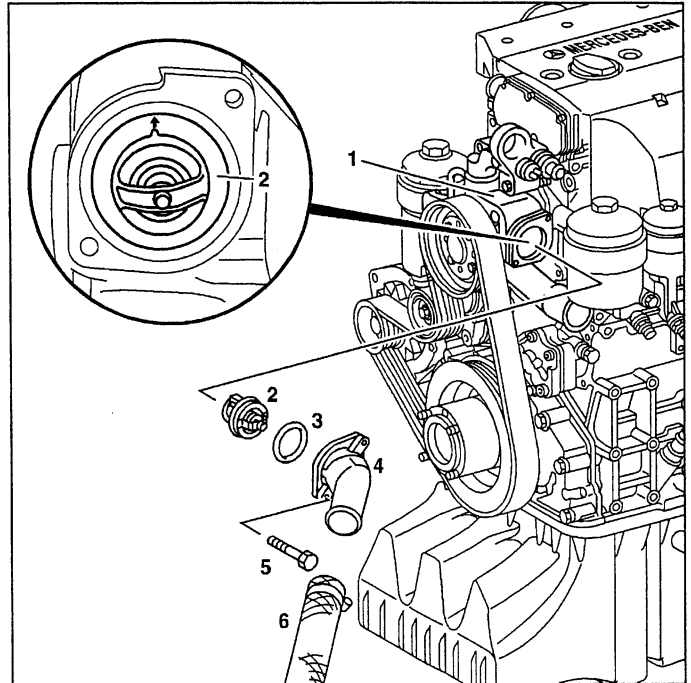

ENGINE 906.940 /941 /951 /952 in MODEL 957

- 1 Coolant pump
- 2 Coolant thermostat
- 3 O-ring.
- 4 Coolant line
- 5 Bolt
- 6 Coolant hose



W20.10-0015-12

☒ ☒	Removing, installing		
<p>⚠ Danger!</p> <p>1</p> <p>AP</p> <p>AP</p> <p>ⓘ</p>	<p>Risk of injury to skin and eyes from scalding with hot coolant which splashes out. Risk of poisoning from swallowing coolant.</p> <p>Drain coolant</p> <p>Notes on coolant</p>	<p>Do not open cooling system unless coolant temperature is below 90 °C. Open cap slowly and release the pressure. Do not pour coolant into beverage bottles. Wear protective gloves, protective clothing and eye protection.</p> <p>Engine 904.905- 907/921</p> <p>Engine 904.908/923</p> <p>Engine 904.909-911/915-917/922</p> <p>Engine 906.910/911/915/916/919-923/ 925-928/939-943/951/952</p>	<p>Page 32</p> <p>WH2080</p> <p>AP20.00-D-2080A</p> <p>AP20.00-W-2080A</p> <p>Page 33</p>
<p>⚠ Danger!</p> <p>2.1</p> <p>ⓘ</p>	<p>Risk of injury from hand being jammed and bruised when tilting cab</p> <p>Tilt cab</p> <p>Notes on tilting cab</p>	<p>No person must be within the tilting range of the cab when the cab is tilted. Always tilt cab as far as the end position and secure with safety prop.</p> <p>Model 375, 673-679, 950-954, 957, 970-976</p>	<p>Page 8</p> <p>Page 8</p>
2.2	Remove service cover	Model 668, 670	
3	Remove coolant line (4)	<p>ⓘ Collect coolant which flows out</p> <p>Nm</p>	BA20.10-N-1004-01C

4	Remove coolant thermostat (2)	 Installation: Replace O-ring (3). Pay attention to installation position of coolant thermostat. The vent opening (arrow) must always be pointing up.	
5	Test coolant thermostat (2)		Page 57
6	Install in the reverse order		
7	Inspect coolant level and inspect cooling system for leaks  AP  AP	Engine 904.905- 907/921 Engine 904.908/923 Engine 904.909-911/915-917/922 Engine 906.910/911/915/916/919-923/ 925-928/939-943/951/952	WH2080 AP20.00-D-2080A AP20.00-W-2080A

 **Coolant pump, coolant thermostat**

Number	Designation	Engine 904.9, 906.9
BA20.10-N-1004-01C	Coolant line coolant thermostat to coolant pump	Nm 25

ENGINE 904.9, 906.9
ENGINE 541.9, 542.9

- 1 Coolant thermostat
 1/1 Main valve
 1/2 Bypass valve

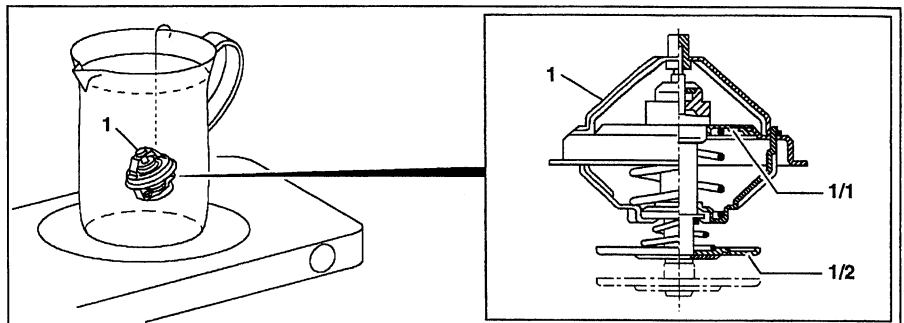

W20.10-0005-04

Shown on engine 906.920-923/925-928

- 1 Coolant thermostat
 1/1 Main valve

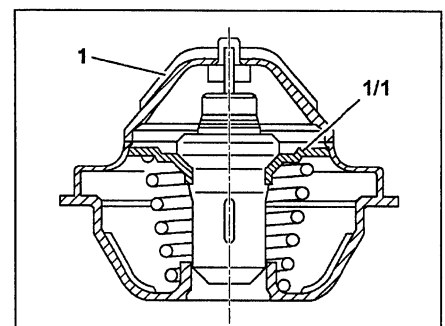

W20.10-1001-01

☐	Inspecting		
1	Remove coolant thermostat (1)	Engine 904.905-907/909-911/915-917/ 921/922, 906.910/911/915/916/919-923/ 925-928/939-941/951/952 Engine 904.908/923 in model 668, 670 Engine 541.920-927/940-947, 542.920- 923/925/926/940-944	Page 55 AR20.10-W-2460B
2	Suspend coolant thermostat (1) from a wire in a vessel filled with water		
⚠ Danger! 3	Risk of injury to skin and eyes from handling hot or glowing objects. Heat water with a suitable source of heat. Stir water so that the temperature of the water is the same at all points	Wear protective gloves, protective clothing and, if appropriate, eye protection. ⚡ On no account use a welding torch or soldering tool for heating the coolant thermostat (1).	Page 54
4	Measure temperature of water	i The heating-up rate should be not more than 1°C to 2°C/min from about 8 °C below the start of opening of the coolant thermostat. Pay attention to standard or tropical version of coolant thermostat (1).	BE20.10-N-1001-02A
5	Heat water to the full opening temperature of the bypass valve (1/2)	Except engine 906.920-923/925-928	BE20.10-N-1003-02A
6	Heat water to the full opening temperature of the main valve (1/1), measure stroke	i Main valve (1/1) must be fully opened after 6 to 8 minutes. If the specifications are not achieved ↓ replace coolant thermostat (1).	BE20.10-N-1002-02A

7	Install coolant thermostat (1)	Engine 904.905-907/909-911/915-917/ 921/922, 906.910/911/915/916/919-923/ 925-928/939-941/951/952 Engine 904.908/923 in MODEL 668, 670 Engine 541.920-927/940-947, 542.920- 923/925/926/940-944	Page 55 AR20.10-W-2460B
---	--------------------------------	--	---------------------------------------

Test data of coolant thermostat

Number	Designation	Engine 904, 906
BE20.10-N-1001-02A	Coolant thermostat - start of opening	°C 83 ± 2
BE20.10-N-1002-02A	Coolant thermostat - main valve	Fully open °C 95
		Stroke mm ≥ 8
BE20.10-N-1003-02A	Coolant thermostat - bypass valve closed at	°C 92

Test data of coolant thermostat

Number	Designation	Engine 541, 542
BE20.10-N-1001-02B	Coolant thermostat - start of opening	°C 83 ± 2
BE20.10-N-1002-02B	Coolant thermostat - main valve	Fully open °C 95
		Stroke mm ≥ 8
BE20.10-N-1003-02B	Coolant thermostat - bypass valve closed at	°C 92

ENGINE 904.909 /910 /911 /915 /916 /917 /922, 906.910 /911 /915 /916 /939 /942 /943

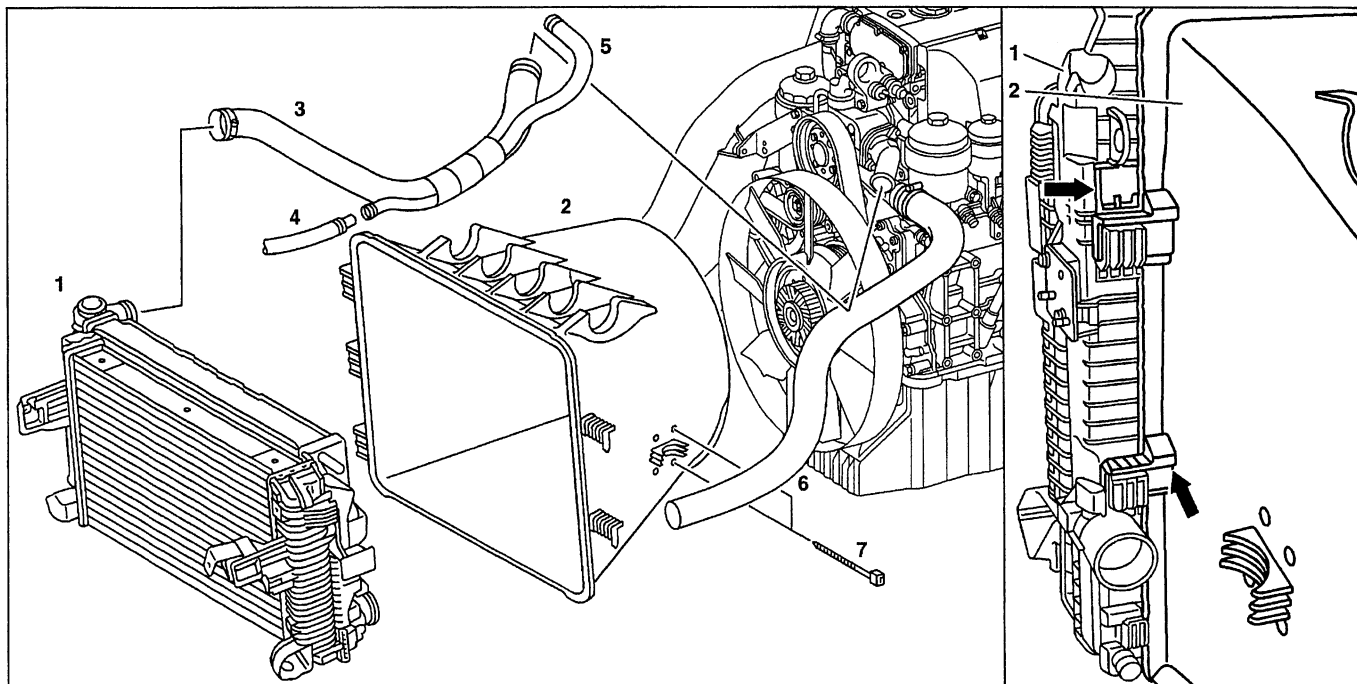





W20.40-0004-09

- 1 Radiator with charge air cooler
 2 Fan shroud
 3 Coolant hose (coolant line)
 4 Coolant hose (heating)

- 5 Coolant hose (heating)
 6 Coolant hose (coolant pump)
 7 Cable strap

	Removing, installing		
Danger! 1 AP 	Risk of injury to skin and eyes from scalding with hot coolant which splashes out. Risk of poisoning from swallowing coolant. Drain coolant at radiator (1) Notes on coolant	Do not open cooling system unless coolant temperature is below 90 °C. Open cap slowly and release the pressure. Do not pour coolant into beverage bottles. Wear protective gloves, protective clothing and eye protection.	Page 32 AP20.00-W-2080A Page 33
Danger! 2 	Risk of injury from hand being jammed and bruised when tilting cab Tilt cab into repair position Notes on tilting cab	No person must be within the tilting range of the cab when the cab is tilted. Always tilt cab as far as the end position and secure with safety prop. Model 375, 673-679, 950-954, 957, 970-976	Page 8 Page 8
3	Remove noise encapsulation on side and at bottom		
4	Detach coolant hose (3) at the coolant line and at the radiator (1)		
5	Separate coolant hoses (4, 5) and detach coolant hose (5) at the connection piece		

6	Detach coolant hose (6) at the side of the fan shroud (2)	 Engine 904.909-911/915-917/922	
7	Remove coolant hose (4) at radiator (1)		
8	Remove fan shroud (2) at radiator (1)	 The fan shroud is secured at the two top radiator mounting brackets and inserted at the bottom.	
9	Lift fan shroud (2) up and out	 Do not damage radiator.  Installation: Engine 904.909-911/915-917/922: feed in both cable straps (7) at the fan shroud before installing.	
10	Install in the reverse order		
11	Inspect coolant level and inspect cooling system for leaks		
			AP20.00-W-2080A

ENGINE 904.909 /910 /911 /915 /916 /917 /922, 906.910 /911 /915 /916 /919 /920 /921 /922 /923 /925 /926 /927 /928 /939 /942 /943

- 1 Viscous fan clutch
- 2 Nut
- 3 Fan
- 4 Nut (engine 904)
- 5 Bolt (engine 906)
- 6 Coolant hose

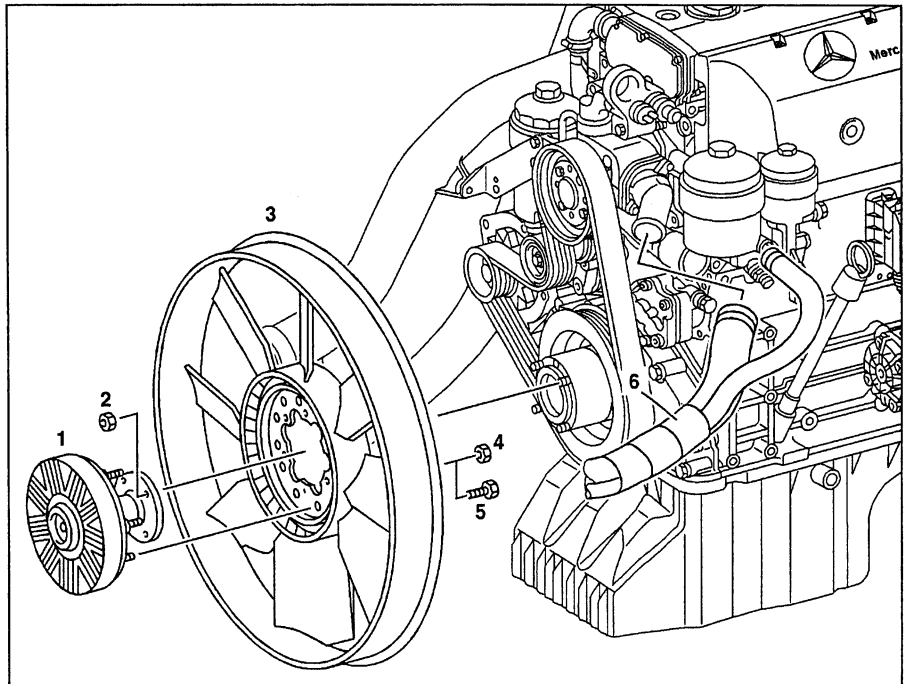

W20.40-0003-06

	Removing, installing		
Danger!	Risk of injury from hand being jammed and bruised when tilting cab	No person must be within the tilting range of the cab when the cab is tilted. Always tilt cab as far as the end position and secure with safety prop.	Page 8
1	Tilt cab into repair position		
	Notes on tilting cab	Models 375, 673-679, 950-954, 970-976	Page 8
2	Remove noise encapsulation panels		
3	Remove charge air pipe from turbocharger to charge air cooler		AR09.41-W-1311C
4	Remove charge air pipe from charge air cooler to charge air manifold		AR09.41-W-1311D
Danger!	Risk of injury to skin and eyes from scalding with hot coolant which splashes out. Risk of poisoning from swallowing coolant.	Do not open cooling system unless coolant temperature is below 90 °C. Open cap slowly and release the pressure. Do not pour coolant into beverage bottles. Wear protective gloves, protective clothing and eye protection.	Page 32
5	Drain coolant		
			AP20.00-W-2080A
	Notes on coolant		Page 33
6	Remove coolant hoses at the coolant pump and connection piece		
7	Detach viscous fan clutch (1) together with fan (2) at intermediate piece and take out	Installation: The viscous fan clutch and fan must be stored upright for at least 1 hour before being installed.	

		Nm	BA20.40-N-1003-01G
8	Detach viscous fan clutch (1) at fan (2)	Nm	BA20.40-N-1002-01G
9	Install in the reverse order		

Nm Fan, fan clutch

Number	Designation		Engine 904.905/ 906/907/909/ 910/911/915/ 916/917/921/922, 906.910/911/915/ 916/919/920/ 921/922/923/ 925/926/927/ 928/939
BA20.40-N-1002-01G	Fan to viscous fan clutch	Nm	25
BA20.40-N-1003-01G	Nut of viscous fan clutch to intermediate piece	Nm	25

ENGINE 904.905 /906 /907 /921

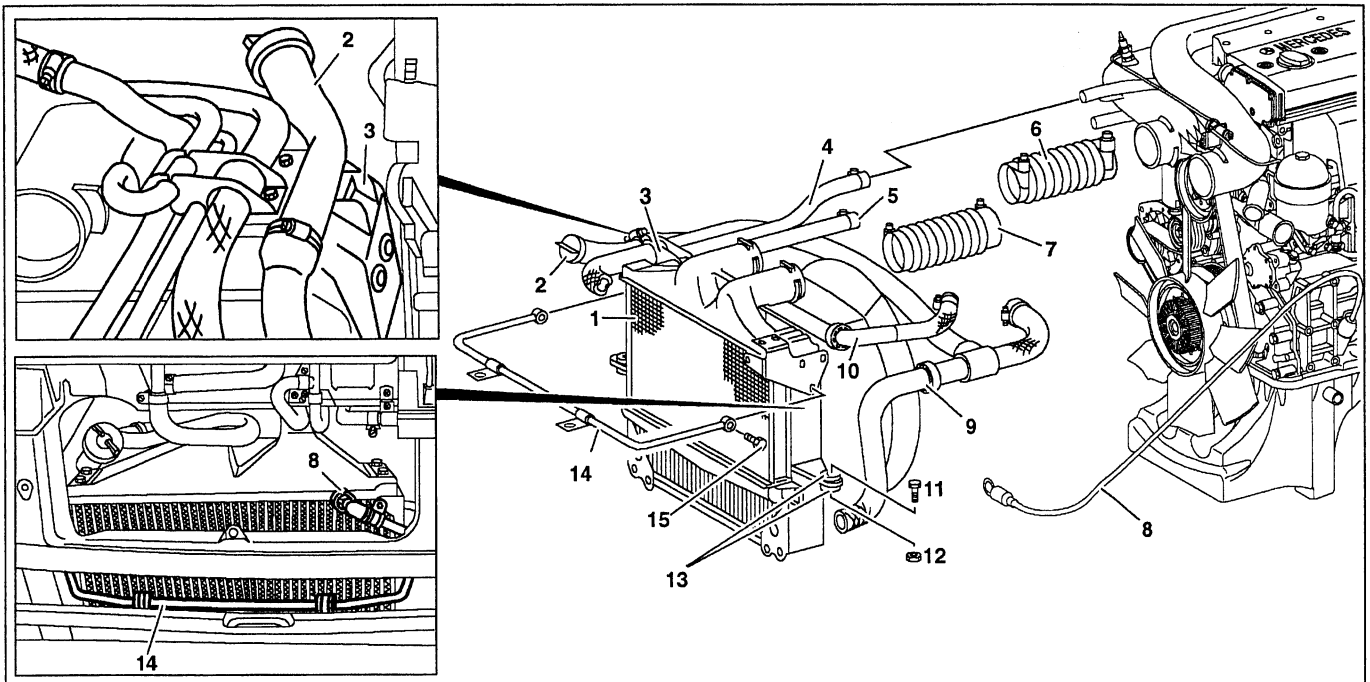

W20.20-0001-09

- | | |
|---------------------------------|--------------------------------|
| 1 Radiator with intercooler | 9 Coolant hose (coolant pump) |
| 2 Oil filler pipe | 10 Coolant hose (coolant pump) |
| 3 Bracket with mounting bracket | 11 Bolt |
| 4 Coolant hose (ventilation) | 12 Nut |
| 5 Coolant hose (heating) | 13 Radiator mounting |
| 6 Boost air hose | 14 Support |
| 7 Boost air hose (red) | 15 Bolt |
| 8 Dipstick guide tube | |

	Removing, installing		
Danger!	Risk of injury to skin and eyes from scalding from hot coolant which splashes out. Risk of poisoning from swallowing coolant	Do not open the cooling system unless the coolant temperature is below 90 °C. Open cap slowly and allow the pressure to release. Do not pour coolant into containers for drinks. Wear protective gloves, protective clothes, and eye protection.	Page 32
1	Drain coolant fully	Collect coolant.	WH2080
	Notes re coolant		Page 33
2	Open service flap		
3	Remove dipstick guide tube (8) at radiator bracket		
4	Remove support (14) at radiator bracket and waistrail		
Danger!	Risk of injury from bruises and jamming when tilting cap	No person should be in the tilting area of the cab when it is being tilted. Always tilt cab as far as the end position and secure with a safety prop.	Page 8
5	Tilt cab		

			Page 8
⑬ 6	Notes re tilting cab Tilt cab into repair position		AR60.80-W-0010A
7	Remove noise encapsulation at side and below	ⓘ On side and at bottom	
8	Remove boost air hoses (6, 7)	ⓘ Installation: boost air hoses must not be mixed up. ⑬ Red boost air hose (7) is temperature-resistant and should always be installed between boost air pipe and intercooler.	
9	Detach coolant hoses (4, 5, 9, 10) at the coolant lines and at radiator (1)	ⓘ Collect coolant which flows out.	
10	Remove bracket (3) on right of radiator, take off mounting bracket with coolant pipes, oil filler pipe (2) and place to the front and tie up		
11	Remove radiator and intercooler (1) downward	⑬ Do not damage radiator and intercooler. ⓘ Inspect radiator mounting for signs of wear; replace mounting if necessary.	
12	Install in the reverse order		
14	Inspect coolant level and check cooling system for leaks		WH2080



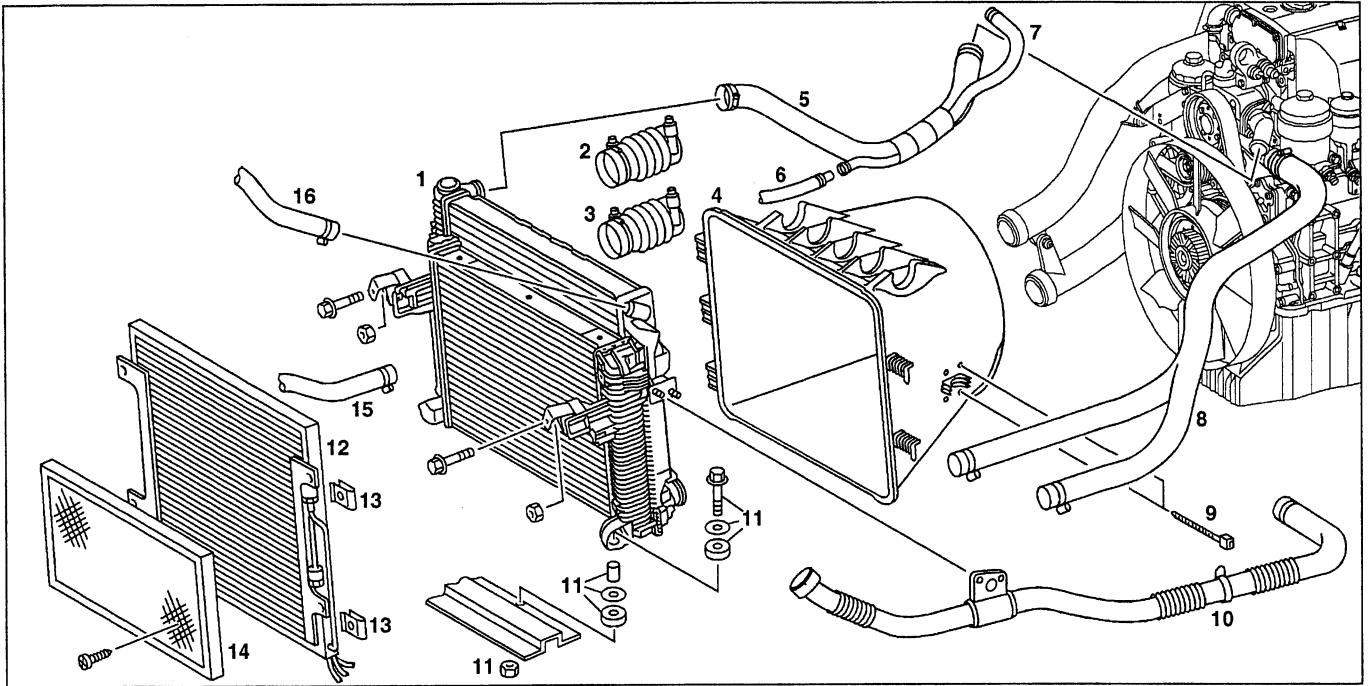







ENGINE 904.909 /910 /911 /915 /916 /917 /922



W20.20-0005-09

- | | | | |
|---|---------------------------------|----|------------------------------------|
| 1 | Radiator with charge air cooler | 9 | Cable strap |
| 2 | Charge air hose (red) | 10 | Oil filler line |
| 3 | Charge air hose (black) | 11 | Radiator mounting |
| 4 | Fan shroud | 12 | Heat exchanger (air conditioning) |
| 5 | Coolant hose (coolant line) | 13 | Clip |
| 6 | Coolant hose (heating) | 14 | Protective grille |
| 7 | Coolant hose (heating) | 15 | Coolant hose (expansion reservoir) |
| 8 | Coolant hose (coolant pump) | 16 | Coolant hose (heating) |

	Removing, installing		
1	Open service flap		
2	Remove protective grille (14) in front of charge air cooler	Remove from the front.	
3	Remove heat exchanger (12) at charge air cooler	If AC fitted. Do not damage heat exchanger and tie up at the cab mounting. Do not separate coolant lines.	
Danger!	Risk of injury from hand being jammed and bruised when tilting cab	No person must be within the tilting range of the cab when the cab is tilted. Always tilt cab as far as the end position and secure with safety prop.	Page 8
4 	Tilt cab into repair position Notes on tilting cab	Model 375, 950, 952, 953, 954	Page 8
Danger!	Risk of injury to skin and eyes from scalding with hot coolant which splashes out. Risk of poisoning from swallowing coolant.	Do not open cooling system unless coolant temperature is below 90 °C. Open cap slowly and release the pressure. Do not pour coolant into beverage bottles. Wear protective gloves, protective clothing and eye protection.	Page 32

5	Drain coolant at radiator (1)		AP20.00-W-2080A
 AP	Notes on coolant		Page 33
			
6	Remove noise encapsulation panels		
7	Remove charge air hoses (2, 3)	<p> Installation: The charge air hoses must not be mixed up.</p> <p> The red charge air hose (2) is temperature-resistant and must always be installed between charge air pipe and charge air cooler.</p>	
8	Remove oil filler pipe (10) at radiator (1)	 Tie up at chassis.	
9	Disconnect coolant hoses (5, 7, 8, 16) at the coolant lines and at the radiator (1)		
10	Disconnect coolant hoses (5, 7) at the engine		
11	Remove coolant hose (8) at the side of the fan shroud (2) and coolant hose (15) at the radiator (1)		
12	Take off both brackets (charge air cooler) at the cab mounting		
13	Remove radiator with charge air cooler (1) downward at the frame crossmember	 Inspect radiator mountings (11) for wear, replace if necessary.	
14	Lift radiator and charge air cooler (1) up and out	<p> Do not damage radiator and charge air cooler.</p> <p> Installation: Feed in both cable straps (9) at the fan shroud (4) before installing.</p>	
15	Remove fan shroud (2) at radiator (1)	 The fan shroud is secured at the two top radiator mounting brackets and inserted at the bottom.	
16	Remove charge air cooler at radiator (1)	 The charge air cooler is secured at the two side radiator mountings and inserted on the right.	
17	Install in the reverse order		
18	Inspect coolant level and inspect cooling system for leaks		
 AP			AP20.00-W-2080A



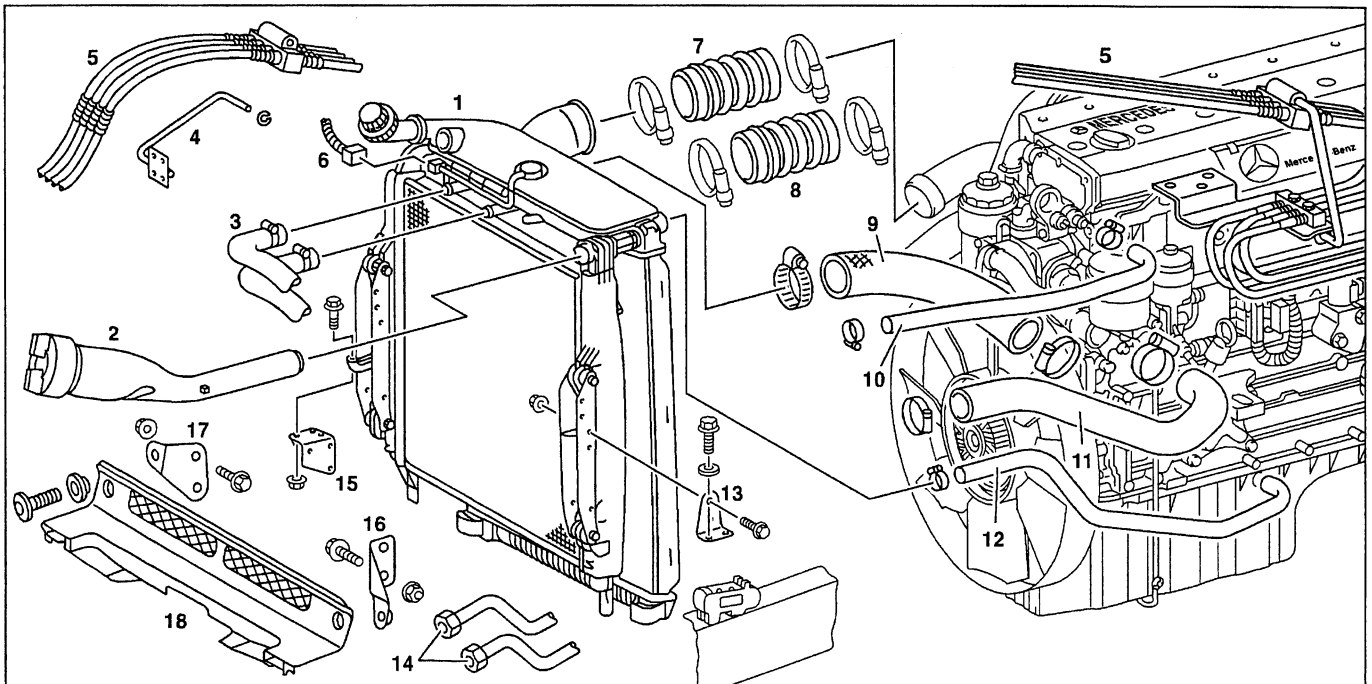















ENGINE 906.920 /921 /922 /923 /925 /926 /927 /928 /942 /943



W20.20-1001-09

- | | | | |
|---|---|----|-----------------------------|
| 1 | Radiator with charge air cooler and coolant expansion reservoir | 10 | Coolant hose |
| 2 | Oil filler neck | 11 | Coolant hose (coolant pump) |
| 3 | Coolant hose (heating) | 12 | Oil filler hose |
| 4 | Tension relief linkage of HPS hydraulic lines | 13 | Bracket |
| 5 | HPS hydraulic line | 14 | Transmission oil line |
| 6 | Plug connector | 15 | Bracket |
| 7 | Charge air hose (red) | 16 | Bracket |
| 8 | Charge air hose (black) | 17 | Bracket |
| 9 | Coolant hose (coolant thermostat) | 18 | Protective grille |

	Removal, installation		
	Installation	Replace all self-locking nuts and bolts	
1	Remove noise encapsulation panels below the radiator and engine		
	Danger! Risk of injury to skin and eyes from scalding with hot coolant which splashes out. Risk of poisoning from swallowing coolant.	Do not open cooling system unless coolant temperature is below 90 °C. Open cap slowly and release the pressure. Do not pour coolant into beverage bottles. Wear protective gloves, protective clothing and eye protection.	Page 32
	Notes on coolant	All engines	Page 33
2	Drain coolant at radiator and engine		
			AP20.00-W-2080A
3	Open service flap		
4	Remove front grille		000 589 01 10 00
5	Remove protective grille (18), bracket (16, 17) at charge air cooler (1) and bumper		

6	Remove bracket (13) at charge air cooler and bottom left of radiator (1)	 Secure radiator to prevent it toppling.	
7	Disconnect transmission oil lines (14) at bottom of radiator (1)	 Collect transmission oil which flows out Seal openings with plugs.	
 Danger!	Risk of injury from hand being jammed and bruised when tilting cab	No person must be within the tilting range of the cab when the cab is tilted. Always tilt cab as far as the end position and secure with safety prop.	Page 8
8 	Tilt cab Notes on tilting cab	Model 375, 950, 952, 953, 954	Page 8
9	Remove noise encapsulation panels on side		
10	Separate plug connector (6) of the coolant level gage at the coolant expansion reservoir		
11	Remove charge air hoses (7, 8)	 Inspect condition of charge air hoses and hose clamps, replace if necessary.  Installation: The charge air hoses must not be mixed up.  The red charge air hose (7) is temperature-resistant and must always be installed between charge air pipe and charge air cooler (1).	
12	Separate coolant hoses (3, 9, 10, 11) at radiator and at coolant expansion reservoir or engine (1)	 Inspect condition of coolant hoses and hose clamps, replace if necessary.	
13	Take off tension relief linkage (4) of the HPS hydraulic lines (5) at the cab	 Do not separate hydraulic lines	
14	Take off shift rod at relay lever	 Model 375	
15	Remove oil filler neck (2)	 Turn oil filler neck (2) at the bayonet connection at the radiator and pull out.	
16	Detach oil filler hose (12) at radiator and tie up at engine	 Seal opening.	
17	Remove bracket (15) at bottom right of radiator	 Secure radiator.	
18	Lift radiator together with charge air cooler and coolant expansion reservoir (1) up and out	 Do not damage radiator, charge air cooler and coolant expansion reservoir.  Installation: After inserting radiator, center radiator to viscous fan until the same distance (clearance) exists between radiator shroud and viscous fan on all sides.	
19	Detach charge air cooler and fan shroud at the radiator		
20	Install in the reverse order		
21  AP	Inspect coolant level and inspect cooling system for leaks		AP20.00-W-2010A
22  AP	Inspect transmissio oil level	 Top up oil to lower edge of oil filler opening	AP26.00-W-2601A

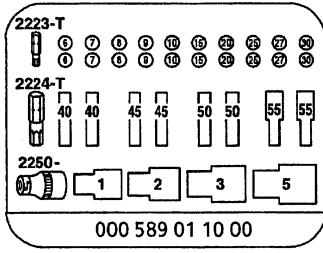

Torx bit set

ENGINE 904.909 /910 /911 /915 /916 /917 /922, 906.910 /911 /915 /916 with BODY 972.899

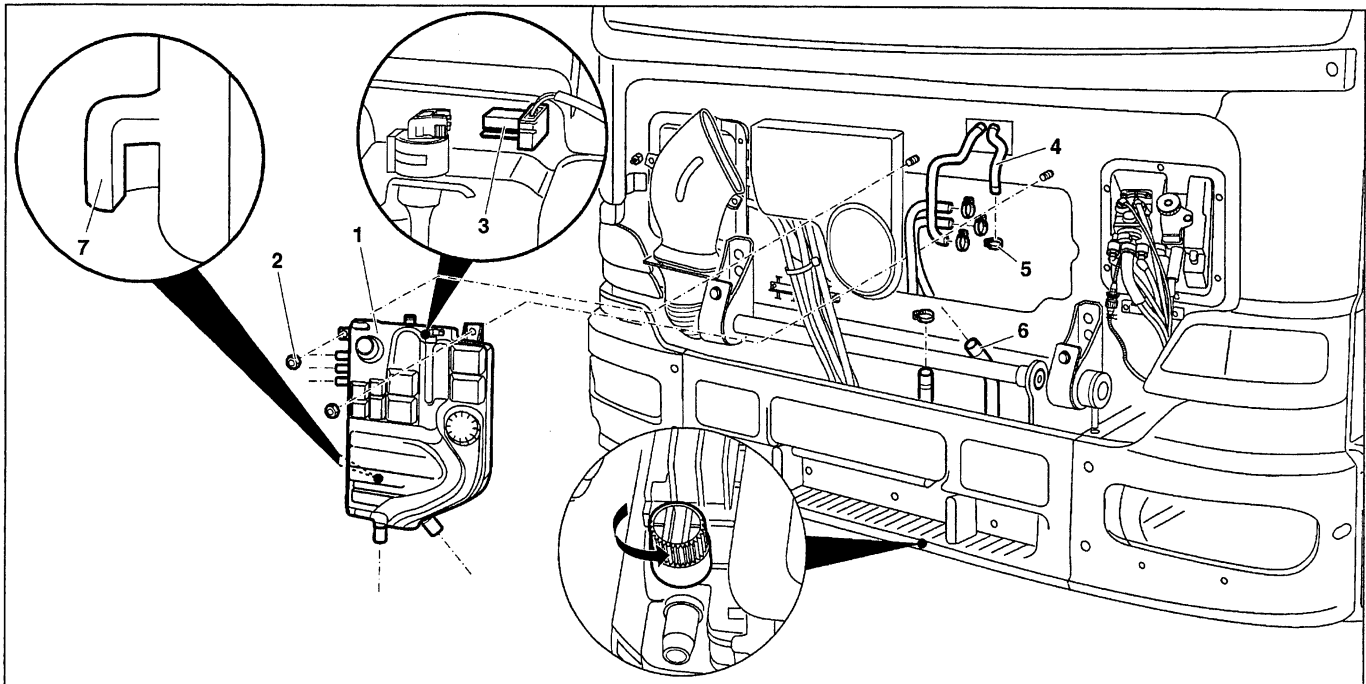

W20.30-0003-09

1 Expansion reservoir
2 Hexagon nut

3 Plug connection of coolant level sensor
4 Coolant hose

5 Hose clamp
6 Oil filler pipe
7 Retaining hook

	Removal, installation		
1	Open front flap		
2	Remove trim grille		
Danger!	Risk of injury to skin and eyes from scalding with hot coolant which splashes out. Risk of poisoning from swallowing coolant.	Do not open cap of the expansion reservoir or radiator unless coolant temperature is below 90 °C. Turn cap carefully to the first detent or slacken one turn. Wear protective clothing.	Page 32
3	Allow pressure in coolant circuit to escape		
4	Unscrew cap of expansion reservoir (1)		
5	Drain coolant into a clean vessel	Open drain cock at vehicle radiator.	
6	Separate plug connection (3) to coolant level sensor		
7	Detach coolant hoses (4) from expansion reservoir		
8	Detach oil filler pipe (6) from connection of expansion reservoir (1)		
9	Remove expansion reservoir (1)	Lift expansion reservoir up and out. Installation: Attach hook (7) at opening of firewall. 	BA60.80-N-1011-01C
10	Install in the reverse order		

11	 Danger!	Risk of accident from vehicle starting off by itself when engine running. Risk of injury as a result of bruises and burns if you insert your hand into the engine when it is started or when it is running	Risk of injury! Secure vehicle to prevent it moving off when carrying out work on the running engine. Wear suitable work clothes when carrying out work on the vehicle.	Page 9
		Start engine and bleed cooling and heating system.	Warm up engine by running at varying revs for about 1 minute. Constantly top up coolant to the top marking in the coolant expansion reservoir.	
	12	Switch off engine		
13	Inspect coolant hose connections for leaks			

 **Cab**

Number	Designation	Body
		972.889 in model 970, 972, 974, 975, 976
BA60.80-N-1011-01C	Nut of coolant expansion reservoir to firewall	Nm 18

ENGINE 904.905 /906 /907 /909 /910 /911 /915 /916 /917 /921 /922, 906.910 /911 /915 /916 /919 /920 /921 /922 /923 /925 /926 /927 /928 /939 /942 /943

ENGINE 904.908 /923 in MODEL 668, 670





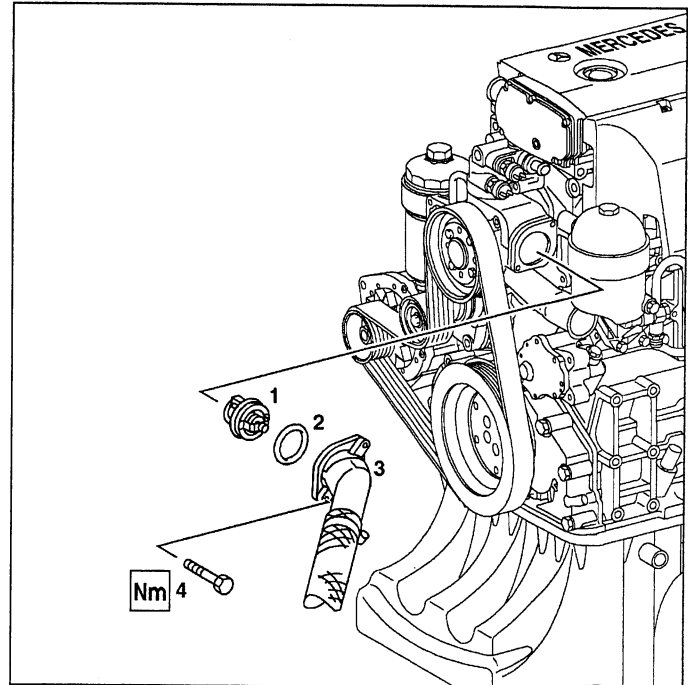







ENGINE 906.940 /941 /951 /952 in MODEL 957

- 1 Coolant thermostat
- 2 Seal
- 3 Coolant line
- 4 Bolt



W20.00-0001-12

	Removing grease		
<p>⚠ Danger!</p> <p>1</p> <p>AP</p> <p>AP</p> <p>ⓘ</p>	<p>Risk of injury to skin and eyes from scalding with hot coolant which splashes out. Risk of poisoning from swallowing coolant.</p> <p>Drain coolant completely and collect</p> <p>Notes on coolant</p>	<p>Do not open cooling system unless coolant temperature is below 90 °C. Open cap slowly and release the pressure. Do not pour coolant into beverage bottles. Wear protective gloves, protective clothing and eye protection.</p> <p>Engine 904.905- 907/921</p> <p>Engine 904.908/923</p> <p>Engine 904.909-911/915-917/922</p> <p>Engine 906.910/911/915/916/919-923/925-928/939/940/941/942/943/951/952</p>	<p>Page 32</p> <p>WH2080</p> <p>AP20.00-D-2080A</p> <p>AP20.00-W-2080A</p> <p>Page 33</p>
2	Remove coolant thermostat (1)		Page 55
3	Block main valve at the coolant thermostat (1) in the opened position		
4	Install coolant line (3) and O-ring (2)	Nm	BA20.10-N-1004-01C
5	Fill cooling system with a 5-% solution of a mildly alkaline cleaner and fresh water	<p>Mixing ratio: 50 g cleaner to 1 l water</p> <p>P3 Croni</p> <p>Grisiron 7220</p>	<p>BR00.45-Z-1011-04A</p> <p>BR00.45-Z-1012-04A</p>

<p> Danger!</p> <p>6</p>	<p>Risk of accident from vehicle starting off by itself when engine running. Risk of injury from bruises and burns if you hold your hand into engine when it is started or when it is running.</p> <p>Warm up engine by running at moderate revs up to approx. 80 °C coolant temperature and hold at this coolant temperature for about 5 minutes</p>	<p>Secure vehicle to prevent it moving off by itself.</p> <p>Wear closed and close-fitting work clothes. Do not grasp hot or rotating parts.</p> <p> The radiator can be covered over if necessary.</p>	<p>Page 9</p>
<p>7</p>	<p>Switch off engine and allow coolant temperature to cool down to approx. 50 °C</p>		
<p>8</p>	<p>Drain solution completely from the cooling system</p>	<p> Dispose of solution in an environmentally compatible way</p>	
<p>9</p>	<p>Rinse cooling system 2 times with fresh water; run the engine for about 5 minutes with each rinsing filling</p>	<p> Dispose of water in an environmentally compatible way</p>	
	<p>Removing scale</p>		
<p>10</p>	<p>Fill cooling system with a 10-% solution of water and citric, tartaric or oxalic acid</p>	<p> Before removing the scale, always remove the grease in the cooling system even if there is no visible sign of oiling. For reasons of wastewater contamination, it is not permitted to use chromic acid or products containing chrome.</p> <p> It is best to use citric acid.</p> <p>Mixing ratio: 100 g citric acid to 1 l water.</p> <p> Chemicals for preparing the solution can be obtained from the chemical trade. Commercially available products which consist of the aforementioned acids, can also be used for removing scale and rust.</p>	
<p>11</p>	<p>Warm up engine by running at moderate revs to approx. 80 °C and hold at this coolant temperature for about 10 minutes</p>		
<p>12</p>	<p>Switch off engine and allow to cool down to approx. 50 °C</p>		
<p>13</p>	<p>Drain solution completely</p>	<p> Dispose of solution in an environmentally compatible way</p>	
<p>14</p>	<p>Rinse cooling system at least 3 times with fresh water; run the engine with each rinsing filling for 5 minutes</p>	<p> Dispose of water in an environmentally compatible way</p>	
<p>15</p>	<p>Remove coolant thermostat</p>		<p>Page 55</p>
<p>16</p>	<p>Remove blocking element at coolant thermostat (1)</p>	<p> Inspect coolant thermostat for damage, replace if necessary.</p>	
<p>17</p>	<p>Install coolant thermostat</p>		<p>Page 55</p>
<p>18</p> <p> AP</p> <p> AP</p>	<p>Fill cooling system with specified coolant and inspect for leaks</p>	<p>Engine 904.905- 907/921</p> <p>Engine 904.908/923</p> <p>Engine 904.909-911/915-917/921/922</p> <p>Engine 906.910/911/915/916/919-923/925-928/939/940/941/942/943/951/952</p>	<p>WH2080</p> <p>AP20.00-D-2080A</p> <p>AP20.00-W-2080A</p>

Nm Coolant pump, coolant thermostat

Number	Designation	Engine 904.9, 906.9
BA20.10-N-1004-01C	Coolant line coolant thermostat to coolant pump	Nm 25

Repair products





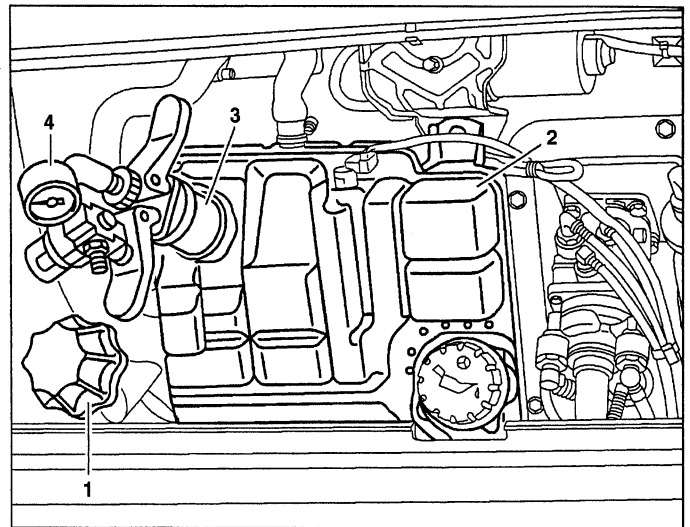

Number	Designation	Order no.
BR00.45-Z-1011-04A	P3 Croni	Manufacturer Henkel
BR00.45-Z-1012-04A	Grisiron 7220	Manufacturer Hoechst



ENGINES 904.909 /910 /911 /915 /916 /917 /922, 906.910 /911 /915 /916 /940 /941 /942 /943 /951 /952

- 1 End cover
 2 Compensating reservoir
 3  Adapter
 4  Tester



W20.00-0004-11

	Inspecting		
 Danger!	Risk of injury to skin and eyes from scalding with hot coolant which splashes out. Risk of poisoning from swallowing coolant.	Do not open cooling system unless coolant temperature is below 90 °C. Open cap slowly and release the pressure. Do not pour coolant into beverage bottles. Wear protective gloves, protective clothing and eye protection.	Page 32
1 	Open cap (1) on compensating reservoir (2) Notes on coolant		Page 33
2	Set heating switches to maximum heating capacity		
3 	Check coolant level and if necessary correct		AP20.00-W-2010A
4	Fit adapter (3) and tester (4) to compensating reservoir (2)	 	001 589 83 21 00 655 589 00 63 00
5	Fill cooling system with compressed air via tester (4)	 Test pressure approx. 1.0 bar and test period approx. 5 to 10 minutes, then release overpressure. A rapid pressure drop is visible on pressure gauge if cooling system is leaking: ↓ Rectify leakage in cooling system: Check condition of cooling and heating hoses as well as coolant lines and their connecting points. Check condition and seating of hose clamps, if necessary retighten or replace parts. If pressure drops with no external leakage: ↓ Check cylinder liners and cylinder head for cracks, if OK: ↓ Test core plug or core plug screw for leaks.	AR01.40-W-0001B

6	Remove adapter (3) and tester (4) from compensating reservoir	 Release overpressure.	
 AP	Check coolant level and if necessary correct		AP20.00-W-2010A

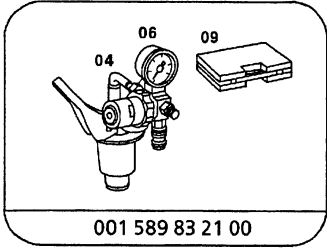

Tester

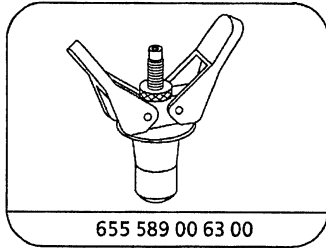

Adapter

STEERING 765.602 /604 /605 /820 /821 /830 /840 /844 /861 /865 /889 with **ENGINE** 904.905 /906 /907 /909 /910 /911 /915 /916 /917 /921 /922, 906.910 /911 /915 /916 /919 /920 /921 /922 /923 /925 /926 /927 /928 /939 /940 /941 /942 /943 /951 /952

- 1 Steering line (pressure)
- 2 Steering line (return flow)
- 3 Power steering pump
- 4 Cross plate
- 5 Hexagon socket bolt

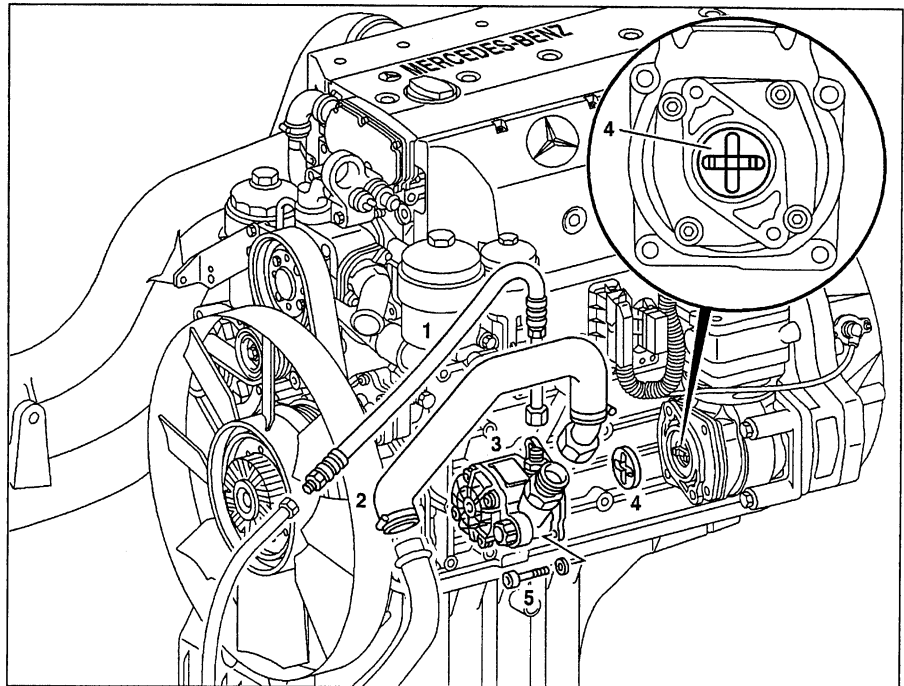

W46.30-0009-06

	Removing, installing		
Danger!	Risk of injury from hand being jammed and bruised when tilting cab	No person must be within the tilting range of the cab when the cab is tilted. Always tilt cab as far as the end position and secure with safety prop.	Page 8
1 	Tilt cab Notes on tilting cab	Model 375, 673-679, 950-954, 957, 970-976	Page 8
2	Remove noise encapsulation on left and at bottom		
Danger!	Risk of injury to skin or eyes from hydraulic fluid spraying out under pressure. Risk of poisoning from swallowing hydraulic fluid.	Render the hydraulic system pressureless before commencing work on system. Wear protective clothing and eye protection.	Page 79
3	Separate both hoses at steering lines	Collect hydraulic fluid which flows out	
4	Detach power steering pump (3) at the compressor		BA46.30-N-1001-01B
5	Take off cross plate (4)	Installation: Rotate crankshaft of compressor until the guides of the cross plate are positioned horizontally. Secure cross plate with grease to prevent it slipping.	
6	Detach hoses at the power steering pump (1, 2)	Counterhold connection in the power steering pump when slackening and collect hydraulic oil which flows out.	
7	Install in the reverse order		
8	Bleed steering	Engine 904.905- 907/921	WH4611

		Engine 904.909-911/915-917/922 Engine 906.910/911/915/916/919-923/ 925-928/939/940/941/942/943/951/952	AR46.25-W-3300C
--	--	--	-----------------

Nm Power steering pump

Number	Designation		Steering 765.602/604/605/ 865 with engine 904	Steering 765.820/821/840/ 844/861/889 with engine 904, 906
BA46.30-N-1001-01B	Bolt of power steering pump to compressor	Nm	40	40

AS00.00-Z-0013-01A	Risk of injury to skin or eyes from pressurized hydraulic fluid spraying out. Risk of poisoning from swallowing hydraulic fluid	Before starting work on the hydraulic system, depressurize the system. Wear protective clothing and safety glasses.	 Danger!
--------------------	--	---	--

Potential danger

Risk of injury

Serious injuries can be caused to the skin or eyes when loosening hydraulic lines without depressurizing the system beforehand, due to the very high pressures (above 200 bar). Damage to the skin may be caused if unprotected skin comes into contact with hydraulic fluid, particularly central hydraulic fluid (this is especially harmful to health).

Risk of poisoning

Anyone who swallows hydraulic fluid can expect to suffer symptoms of poisoning including headaches, dizziness, stomach ache, vomiting, diarrhoea, cramps and unconsciousness

Safety measures/operating instructions

- Before starting work on hydraulic systems they should be depressurized and the system must be emptied if necessary.
- Do not pour hydraulic fluid into drinking containers.
- Ensure adequate ventilation, particularly in the case of central hydraulic fluid.

- Ensure only authorized persons have access to hydraulic fluid.
- Seal disconnected lines and hoses and connections on the subassemblies immediately with blind plugs.
- Wear safety gloves, protective clothing and safety glasses.

If it is not possible to wear safety gloves, the following points are to be observed:

- Only allow hydraulic fluid to come into contact with the skin for as short a time as possible, wash fluid off skin with soap and water.
- Change wet clothing as quickly as possible

First aid

- Have the casualty drink plenty of water with activated charcoal additive.
- After swallowing larger quantities, consult a doctor.
- If hydraulic fluid gets into the eyes, rinse out the eyes immediately with plenty of clean water/using an eye rinsing glass.
- In the event of injuries to skin or eyes from a jet of hydraulic fluid, consult a doctor immediately.

ENGINE 904.905 /906 /907 /921 ## up to 33991
ENGINE 904.908 ## up to 33991 in MODEL 668, 670



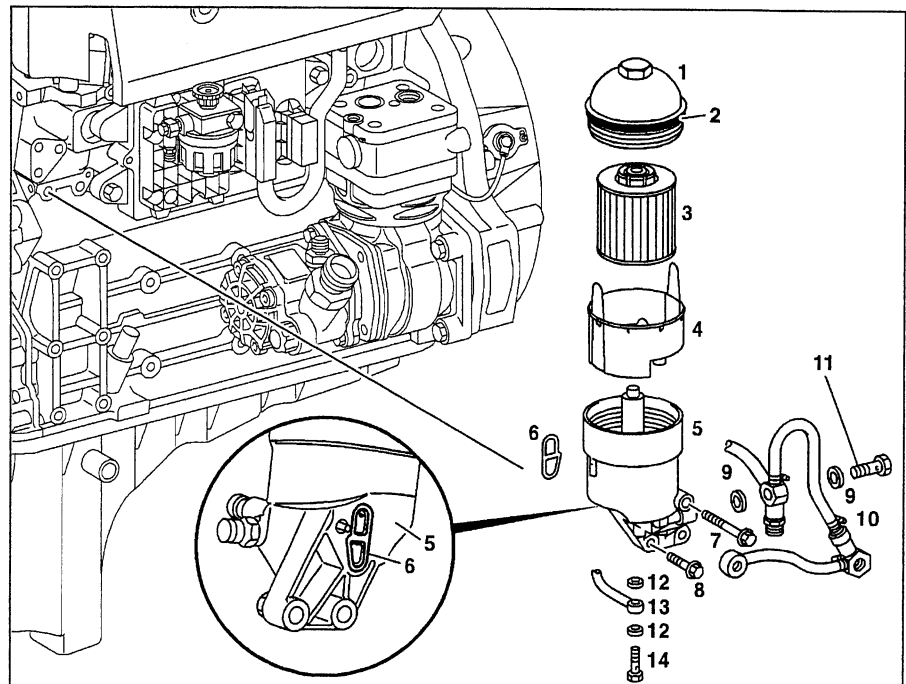





- 1 Fuel filter cap
- 2 Seal
- 3 Fuel filter element
- 4 Dirt collection reservoir
- 5 Fuel filter housing
- 6 Gasket
- 7 Bolt
- 8 Bolt
- 9 Seal
- 10 Fuel line
- 11 Banjo bolt
- 12 Seal
- 13 Fuel line (flame starting system)
- 14 Banjo bolt







W47.20-0002-06

Modification notes

7.7.98	Tightening torque of bolt of fuel filter housing to crankcase added	Step 6	
--------	---	--------	--

	Removing, installing		
 Danger!	Risk of injury from bruises and jamming when tilting cab	No person should be in the tilting area of the cab when it is being tilted. Always tilt cab as far as the end position and secure with a safety prop.	Page 8
1.1	Tilt cab	Model 673- 679	
	Notes on tilting cab		Page 8
1.2	Remove service hood	Model 668, 670	
 Danger!	Risk of explosion from ignition. Risk of poisoning from inhaling and swallowing fuel. Risk of injury as a result of fuel coming into contact with skin and eyes.	No fire, naked flame or smoking. Pour fuels only into suitable and appropriately marked containers. Wear protective clothing when handling fuel.	Page 81
2	Unscrew fuel filter cap (1) together with fuel filter element (3)	<p> When the fuel filter cap is removed, the fuel flows out of the fuel filter housing back along the fuel return flow line into the fuel tank.</p> <p> Installation: inspect seal (2), replace if necessary.</p> <p> Cap to fuel filter housing</p>	BA47.20-N-1001-02A
3	Pull dirt collection reservoir (4) out of the fuel filter housing (5)	 Dispose of fuel and the impurities which have gathered in the dirt collection reservoir	

4	Detach fuel lines (10) at fuel filter housing (5)	 Collect fuel which flows out. Installation: replace seals (9).  Banjo bolt of fuel line to fuel filter	BA47.20-N-1002-02A
5	Detach fuel line (13) at fuel filter housing (5)	 If flame starting system fitted collect fuel which flows out. Installation: replace seals (12).	
6	Detach fuel filter housing at crankcase	 Collect fuel which flows out. Installation: replace gasket (6).  Bolt of fuel filter housing to crankcase	BA47.20-N-1005-02A
7	Install in the reverse order		
8	Bleed fuel system	See Operating Instructions	

 Fuel filter

Number	Designation	Engine 904.9, 906.9	
BA47.20-N-1001-02A	Cap to fuel filter housing	Nm	25
BA47.20-N-1002-02A	Banjo bolt of fuel line to fuel filter	Nm	40
BA47.20-N-1005-02A	Bolt of fuel filter housing to crankcase	Nm	25

AS47.00-Z-0001-01A	Fuel vapors present an explosion hazard. Fuel is toxic when inhaled or swallowed. Contact with fuel can cause skin and eye injury.	No fire, sparks, naked flames or smoking. Pour fuels only into suitable and appropriately marked containers. Wear protective clothing when handling fuel.	 Danger!
--------------------	--	---	--

Possible hazards

Risk of explosion, poisoning and injury

Fuels are easily flammable and poisonous when swallowed. Fuel can cause skin damage. For example, contact with gasoline fuel removes the natural oils of the skin. Fuel vapors are explosive, invisible and disperse on the ground. They are poisonous if inhaled and have a narcotic effect if they are present in high concentrations.

- Store drained fuel in suitable and sealed containers.
- Immediately eliminate fuel which has poured out.

Carrying out work on a vehicle with a naked flame (e.g. welding, etc.)

- Before commencing such work, remove the relevant parts of the fuel system and seal any open fuel lines with plugs.

Protective measures/rules of conduct

- Observe the safety precautions and regulations applicable in the specific country.
- No fire, sparks, naked flames or smoking.
- Ensure that the work place is adequately ventilated.
- Never drain or pour in fuels above assembly pits.

First-aid measures

- Clean moistened skin with soap and water.
- Change moistened clothing as rapidly as possible
- If fuel gets into the eyes, immediately rinse out the eyes with water; contact a doctor, if necessary.

ENGINE 904.905 /906 /907 /908 /921 ## as of 033992

ENGINE 904.909 /910 /911 /915 /916 /917 /922 /923, 906.910 /911 /915 /916 /919 /920 /921 /922 /923 /925 /926 /927 /928 /939 /940 /941 /942 /943 /951 /952

- 1 Fuel filter cap
- 2 Seal
- 3 Fuel filter element
- 4 Dirt collecting vessel
- 5 Fuel filter housing
- 6 Gasket
- 7 Fuel line
- 8 Banjo bolt
- 9 Bolt
- 10 Fuel line (feed)
- 11 Fuel line (return flow)
- 12 Fuel line
- 13 Bolt
- 14 Fuel line (flame starting system)
- 15 Banjo bolt

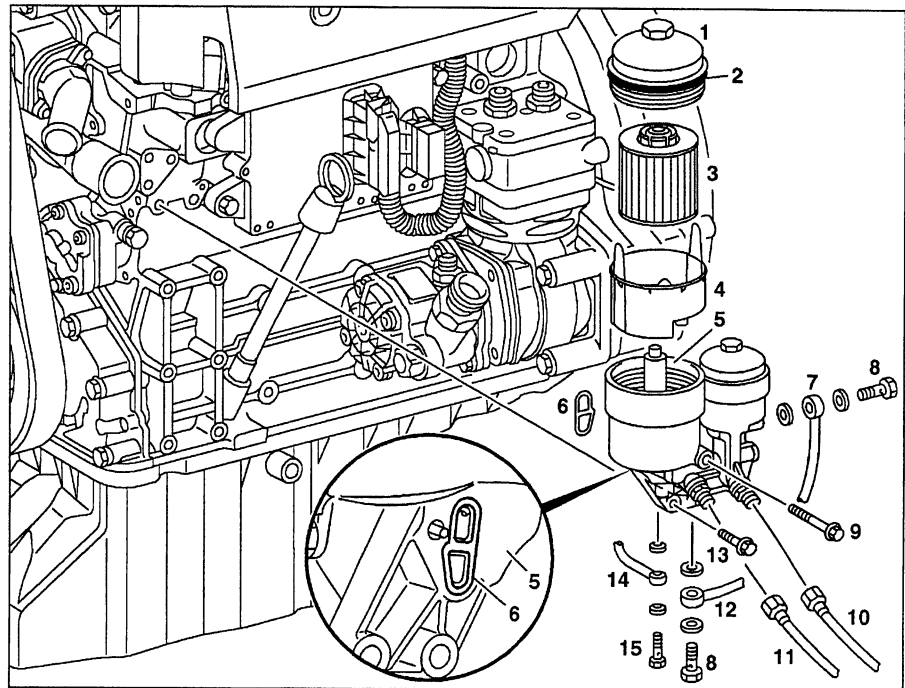







W47.20-0003-06

Modification notes

7.7.98	Tightening torque, bolt of fuel filter housing to crankcase added	Step 7	
--------	---	--------	--

	Removing, installing		
Danger!	Risk of injury from hand being jammed and bruised when tilting cab	No person must be within the tilting range of the cab when the cab is tilted. Always tilt cab as far as the end position and secure with safety prop.	Page 8
1.1	Tilt cab		
	Notes on tilting cab	Model 375, 673-679, 950-954, 957, 970-976	Page 8
1.2	Remove service cover	Model 668, 670	
Danger!	Risk of explosion from ignition, risk of poisoning from inhaling and swallowing fuel, as well as risk of injury from skin and eye contact with fuel.	No fire, sparks, naked flames or smoking. Pour fuels only into suitable and appropriately marked containers. Wear protective clothing when handling fuel.	Page 81
2	Unscrew fuel filter cap (1) together with fuel filter element (3).	When the fuel filter cap is pulled out, the fuel flows back out of the fuel filter housing along the fuel return flow line into the fuel tank if the fuel tank cap is opened. Installation: Inspect seal (2), replace if necessary 	BA47.20-N-1001-02A
3	Pull out dirt collecting vessel (4) from the fuel filter housing (5)	Dispose of fuel and the collected impurities from the dirt collecting vessel.	

4	Detach fuel lines (10, 11) at the fuel filter housing (5)	 Mark fuel lines and collect fuel which flows out.	
5	Detach fuel lines (7, 12) at the fuel filter housing (5)	 Collect fuel which flows out. 	BA47.20-N-1002-02A
6	Detach fuel line (14) at the fuel filter housing (5)	 If flame starting system fitted: collect fuel which flows out.	
7	Detach fuel filter housing at crankcase	 Collect fuel which flows out. 	BA47.20-N-1005-02A
8	Install in the reverse order		



Number	Designation	Engine 904.9, 906.9
BA47.20-N-1001-02A	Cap to fuel filter housing	Nm 25
BA47.20-N-1002-02A	Banjo bolt of fuel line to fuel filter	Nm 40
BA47.20-N-1005-02A	Bolt of fuel filter housing crankcase	Nm 25

ENGINE 904.905 /906 /907 /921 ## up to 33991
 ENGINE 904.908 ## up to 33991 in MODEL 668, 670

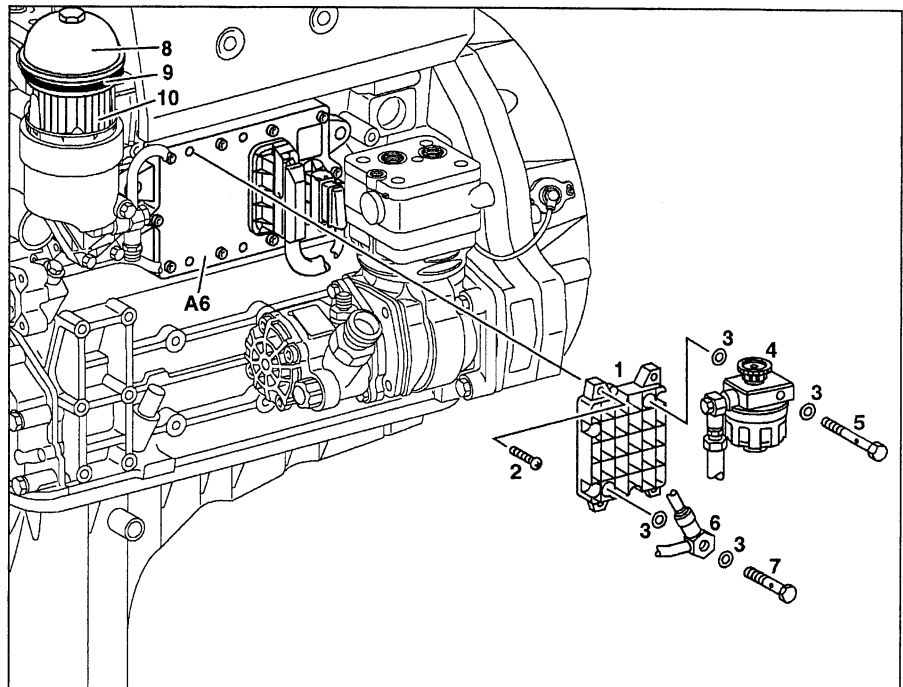

- 1 Fuel heat exchanger
- 2 Bolt
- 3 Seal
- 4 Fuel priming pump
- 5 Banjo bolt
- 6 Fuel line
- 7 Banjo bolt
- 8 Fuel filter cap
- 9 Seal
- 10 Fuel filter element

- A6 PLD control unit



W47.21-0001-06

	<p>Removing, installing</p>		
<p>⚠ Danger!</p> <p>1.1</p> <p></p> <p>1.2</p>	<p>Risk of injury from bruises and jamming when tilting cab</p> <p>Tilt cab</p> <p>Notes on tilting cab</p> <p>Remove service hood</p>	<p>No person should be in the tilting area of the cab when it is being tilted. Always tilt cab as far as the end position and secure with a safety prop.</p> <p>Model 673- 679, 970- 976</p> <p>Model 668, 670</p>	<p>Page 8</p> <p>Page 8</p>
<p>⚠ Danger!</p> <p>2</p>	<p>Risk of explosion from ignition. Risk of poisoning from inhaling and swallowing fuel. Risk of injury as a result of fuel coming into contact with skin and eyes.</p> <p>Unscrew fuel filter cap (8) from the fuel filter housing</p>	<p>No fire, naked flame or smoking. Pour fuels only into suitable and appropriately marked containers. Wear protective clothing when handling fuel.</p> <p> When the fuel filter cap is removed, the fuel flows out of the fuel filter housing back along the fuel return flow line into the fuel tank.</p> <p> Installation: replace seal (9).</p> <p> Fuel filter cap to fuel filter housing</p>	<p>Page 81</p> <p>BA47.20-N-1001-02A</p>
<p>3</p>	<p>Detach fuel priming pump (4) and fuel line (6) at fuel heat exchanger (1)</p>	<p>Collect fuel which flows out.</p> <p> Installation: replace seals (3).</p> <p> Banjo bolt of fuel priming pump to fuel heat exchanger</p> <p> Banjo bolt of fuel line to fuel heat exchanger</p>	<p>BA47.20-N-1003-01A</p> <p>BA47.20-N-1004-01A</p>
<p>4</p>	<p>Detach fuel heat exchanger (1) at PLD control unit (A6)</p>	<p> Fuel heat exchanger must not be disassembled.</p>	

5	Install in the reverse order		
6	Bleed fuel system	Engine 904.905- 908/921/923 See Operating Instructions  , or 	

 Fuel pump

Number	Designation		Engine 904.9, 906.9
BA47.20-N-1003-01A	Banjo bolt of fuel priming pump to fuel heat exchanger	Nm	40
BA47.20-N-1004-01A	Banjo bolt of fuel line to fuel heat exchanger	Nm	40

 Fuel filter

Number	Designation		Engine 904.9, 906.9
BA47.20-N-1001-02A	Cap to fuel filter housing	Nm	25

ENGINE 904.905 /906 /907 /909 /910 /911 /915 /916 /917 /921 /922, 906.910 /911 /915 /916 /919 /920 /921 /922 /923 /925 /926 /927 /928 /939 /942 /943

ENGINE 904.908 /923 in MODEL 668, 670





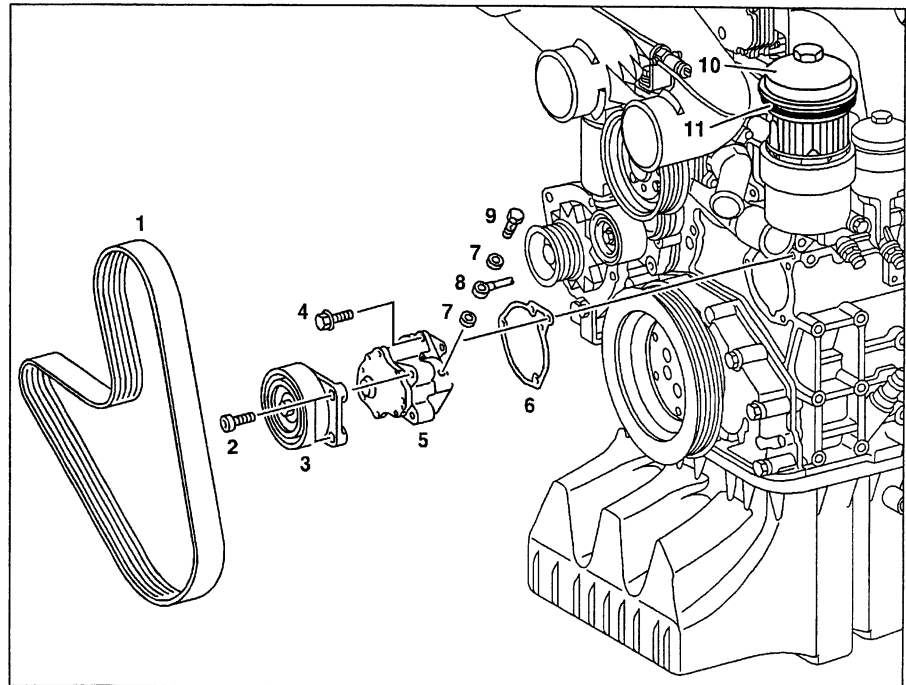

ENGINE 906.940 /941 /951 /952 in MODEL 957

- 1 Poly V-belt
- 2 Hexagon socket bolt
- 3 Guide pulley (only if AC fitted)
- 4 Bolt
- 5 Fuel pump
- 6 Gasket
- 7 Seal
- 8 Fuel line
- 9 Banjo bolt
- 10 Fuel filter cap
- 11 Seal



W47.20-0001-06

☒ ☒	Removing, installing		
<p>⚠ Danger!</p> <p>1.1</p> <p>ⓘ</p>	<p>Risk of injury from hand being jammed and bruised when tilting cab</p> <p>Tilt cab</p> <p>Notes on tilting cab</p>	<p>No person must be within the tilting range of the cab when the cab is tilted. Always tilt cab as far as the end position and secure with safety prop.</p> <p>Model 375, 673-679, 950-954, 957, 970-976</p>	<p>Page 8</p> <p>Page 8</p>
1.2	Remove service cover	Model 668, 670	
2	Slacken poly V-belt (1) and take off	<p>Engine 904.905-907/909-911/915-917/921/922</p> <p>Engine 906.910/911/915/916/919-923/925-928/939/940/941/942/943/951/952</p> <p>Engine 904.908/923</p>	<p>AR13.22-W-1202A</p> <p>AR13.22-D-1202D</p>
3	Take off guide pulley (3) at the fuel pump (5)	<p>ⓘ If AC fitted</p>	
<p>⚠ Danger!</p> <p>4</p>	<p>Risk of explosion from ignition, risk of poisoning from inhaling and swallowing fuel, as well as risk of injury from skin and eye contact with fuel.</p> <p>Unscrew fuel filter cap (10) from the fuel filter housing</p>	<p>No fire, sparks, naked flames or smoking. Pour fuels only into suitable and appropriately marked containers. Wear protective clothing when handling fuel.</p> <p>ⓘ When the fuel filter cap is pulled out, the fuel flows back out of the fuel filter housing along the fuel return flow line into the fuel tank if the fuel tank cap is opened.</p> <p>Nm</p>	<p>Page 81</p> <p>BA47.20-N-1001-02A</p>

5	Detach fuel line (8) at fuel pump (5)	 Collect fuel which flows out. 	BA47.20-N-1002-01A
6	Detach fuel pump (5)	 Collect fuel which flows out.  Installation: When fitting on the fuel pump, the driver at the fuel pump must not be touching the dowel pin of the camshaft. 	BA47.20-N-1001-01A
7	Install in the reverse order		
 Danger! 8	Risk of accident from vehicle starting off by itself when engine running. Risk of injury from bruises and burns if you hold your hand into engine when it is started or when it is running. Bleed fuel system with starter	Secure vehicle to prevent it moving off by itself. Wear closed and close-fitting work clothes. Do not grasp hot or rotating parts.  Start engine with starter for not more than 120 s. Wait about 2 minutes before repeating start operation.	Page 9

 Fuel pump

Number	Designation	Engine 904.9, 906.9
BA47.20-N-1001-01A	Bolt of fuel pump to crankcase	Nm 25
BA47.20-N-1002-01A	Banjo bolt of fuel line to fuel pump	Nm 40



Number	Designation	Engine 904.9, 906.9
BA47.20-N-1001-02A	Cap to fuel filter housing	Nm 25

