

# **OPERATION & MAINTENANCE MANUAL**

## **MITSUBISHI DIESEL ENGINE**

### **S16R**

#### **APPLICATIONS**

- Generator drive
- Prime power
- Locomotive drive
- Construction machinery drive
- Marine generator drive
- Marine prime power



**MITSUBISHI**  
HEAVY INDUSTRIES, LTD.

**WE WELCOME YOU TO THE  
GROWING LIST OF PEOPLE  
WHO OWN AND USE OUR  
DIESEL ENGINE**

**S16R**

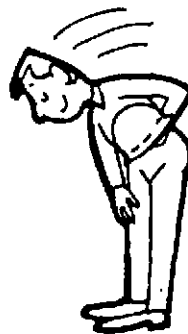

500001

This manual is written to familiarize you with the operation and maintenance of your S16R diesel engine, and provide important safety information. We suggest that you carefully read this manual to learn about your new engine.

After reading this manual, be sure to keep it near your engine as a ready reference when you need it. See your Mitsubishi dealer for any further information you feel you need. He will be glad to help you and answer any questions you may have about handling of your new engine.

The descriptions, illustrations and specifications contained in this manual were in effect at the time it was approved for printing. Mitsubishi reserves the right to change specifications or design without notice and without incurring obligation.

# INDEX

Your engine and Mitsubishi .....	1
Safety rules .....	3
Nomenclature .....	8
Operation instructions .....	9
Before operation .....	9
Operating the engine .....	15
Maintenance instructions .....	18
Maintenance schedule .....	18
Every 10 hours or daily .....	21
Every 50 hours or monthly .....	23
Every 1 year .....	24
Every 250 hours or 1 year .....	25
Every 500 hours or 2 years .....	27
Every 1000 hours or 3 years .....	28
Every 2000 hours or 5 years .....	33
Storage .....	34
Fuels, coolant and lubricants .....	36
Troubleshooting .....	41
Specifications .....	48
Tightening torque .....	49
Schematic .....	52

## YOUR ENGINE AND MITSUBISHI

### SERVICE ASSISTANCE

Mitsubishi dealers are strategically located through the world.

No matter where your engine operates, you can rely on the expert knowledge of servicemen and the service facilities at your dealer.

Should your engine get out of order, contact your dealer by giving the engine serial number and service meter reading.

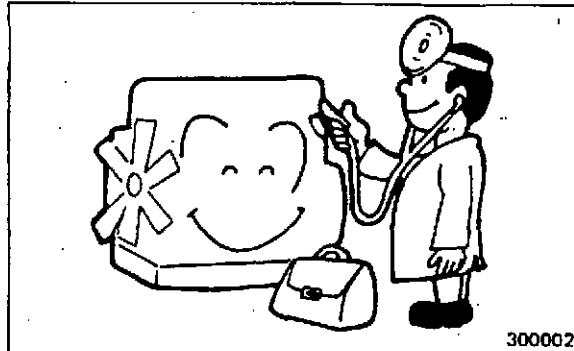

If your engine is transferred to elsewhere from the original place of use registered with Mitsubishi, be sure to have the registration changed. Consult your Mitsubishi dealer for the necessary procedure.

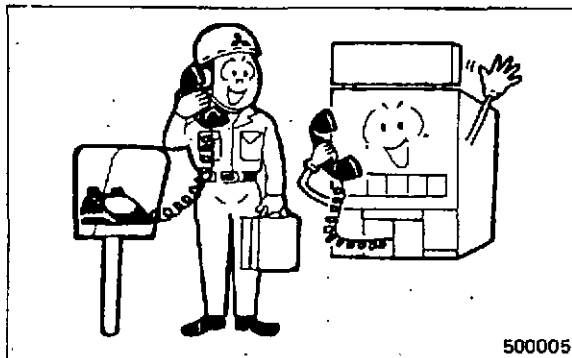

**LOCATION OF ENGINE SERIAL NUMBER**

The engine serial number is stamped on the nameplate attached to the right rear side of the engine.

Example: Model            Serial number  
           S16R                00012

On the nameplate are also stamped the output and rated speed. The numbers in the illustration show cylinder numbers.

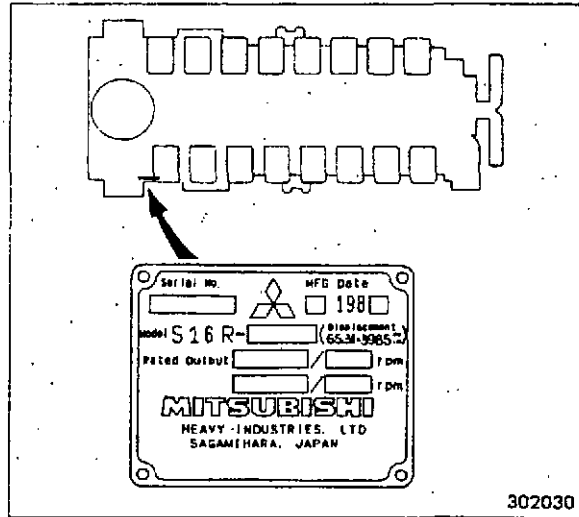

**ENGINE MODEL AND APPLICATION CODES**

- S □ □ - □ T            Turbocharged unit
- S □ □ - □ TA           Turbocharged, aftercooled unit
- S □ □ - □ TK           Turbocharged, intercooled unit

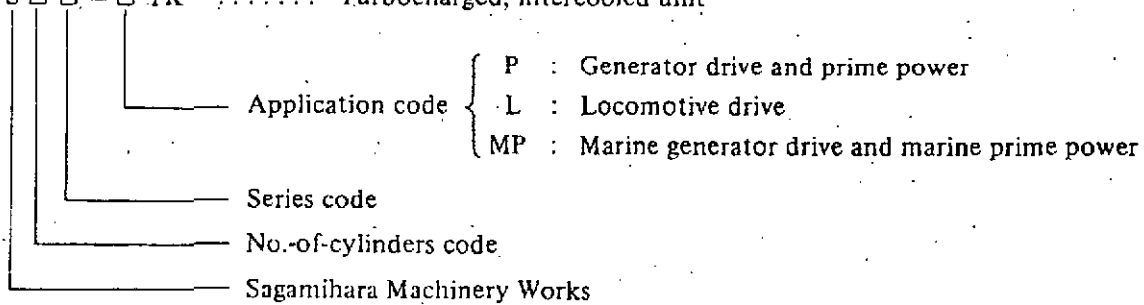

## SAFETY RULES

WARNINGS, CAUTIONS and NOTES are used in this manual to emphasize important and critical instructions. They are used for the following conditions:



**WARNING**

..... Operating procedures, practices, etc., which if not correctly followed, will result in personal injury or loss of life.



**CAUTION**

..... Operating procedures, practices, etc., which if not strictly observed, will result in damage to or destruction of engine.

**NOTE**

..... An operating procedure, condition, etc., which is essential to highlight.

✓

..... Right or normal as a result of inspection

x

..... Wrong or abnormal (service needed) as a result of inspection

### Recommendation of daily operation record

It is obvious to every engine user and operator that an engine should not be run to destruction. Daily recording is a preventive maintenance program and will serve as a guide for:

- Effective troubleshooting (to help a serviceman of your Mitsubishi dealer pin-point the trouble)
- Quick servicing and less downtime (to help him save time for servicing)
- Grasp of operating conditions (to help you recognize conditions, signs or indications of approaching trouble)

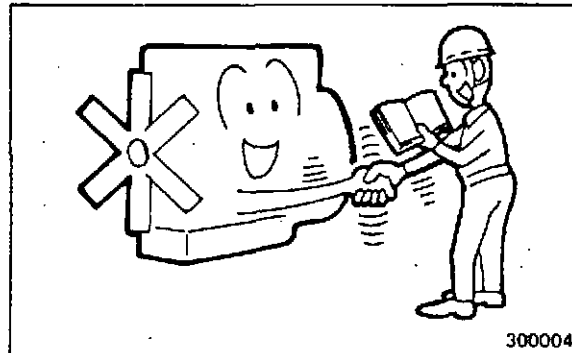

300004

### Items to be recorded

The following items are recommended to be recorded as "daily readings":

1. Operating hours (service meter reading)
2. Quantities of engine oil, fuel oil and water (coolant) used for refilling.
3. Engine oil and coolant change periods
4. Engine oil pressure, exhaust temperature, supply air pressure and fresh water temperature
5. Parts serviced, kinds of service (adjustment, repair or replacement) and results of service
6. Changes in operating conditions (for example, "Exhaust smoke turned black")

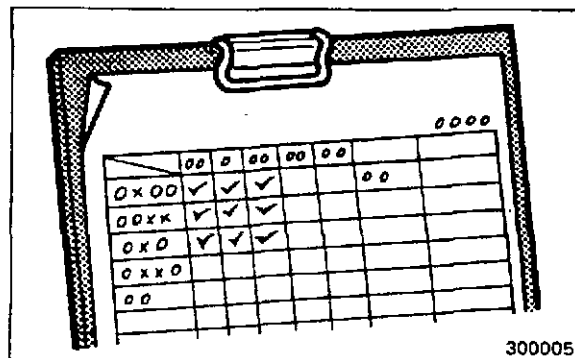

300005

SAFETY RULES

- ⚠ Study **OPERATION & MAINTENANCE MANUAL** to become thoroughly familiar with all engine controls and instruments — and service procedures.

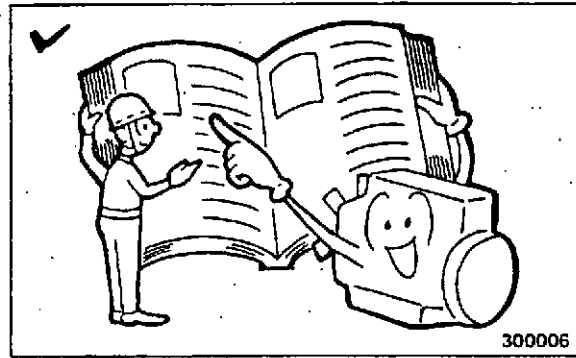

- ⚠ Wear hard hat and safety shoes — and, if job conditions require, safety goggles, heavy gloves, ear protectors, respirators, etc.

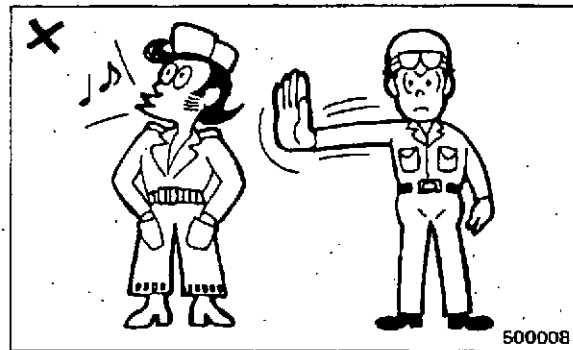

**Before operation**

Before starting and during warm up period, check under and around engine for visual defects — leaks of fuel, oil and coolant, loose or missing part.

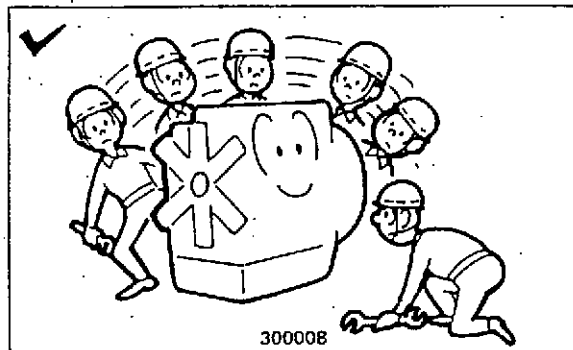

- ⚠ When starting engine, walk around it once more — open eyes and be alert to people and obstacles that may be within operating area.

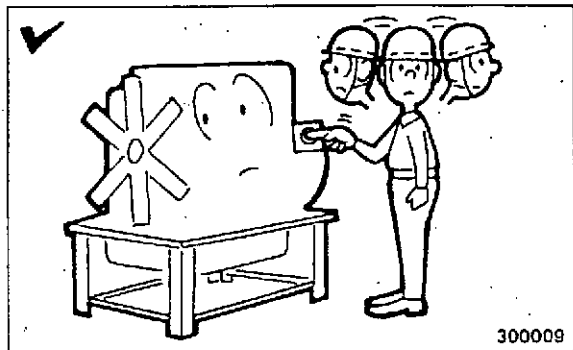

**During operation**

- ⚠ Do not touch any moving part of a running engine, or clothing or hair can be caught in moving parts, resulting in personal injury or loss of life.

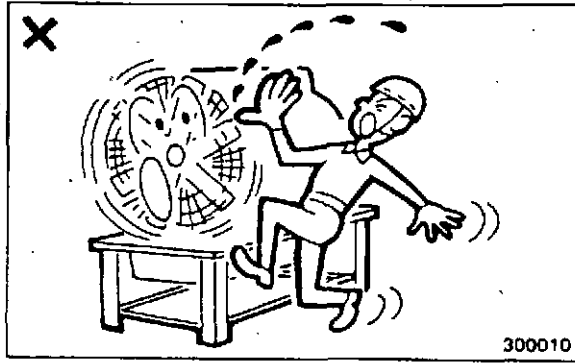

- ⚠ Keep hands off hot parts — turbo-charger, exhaust pipe, etc. — during operation or immediately after shutting off engine.

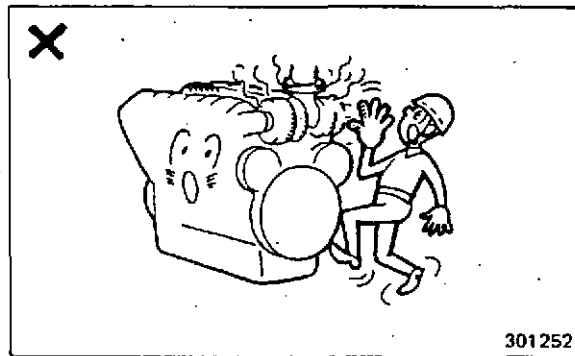

- ⚠ If necessary to operate engine within an enclosed area, provide adequate ventilation — and pay attention to exhaust piping and exhaust gas leaks.

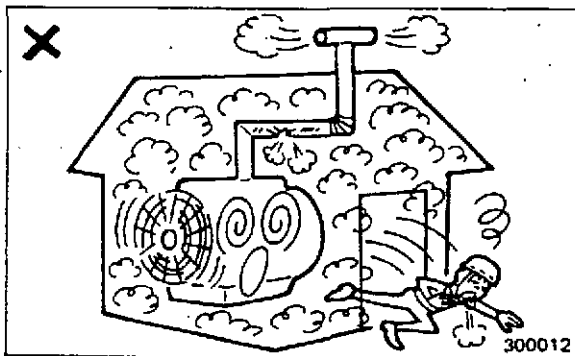
**Idling operation for engine cooling**

After the load is removed, allow the engine to run at low idle speed for about 5 to 6 minutes. During this period, check around the engine for visual defects. Shutting off the engine immediately after removing the load is very hard on the engine parts.

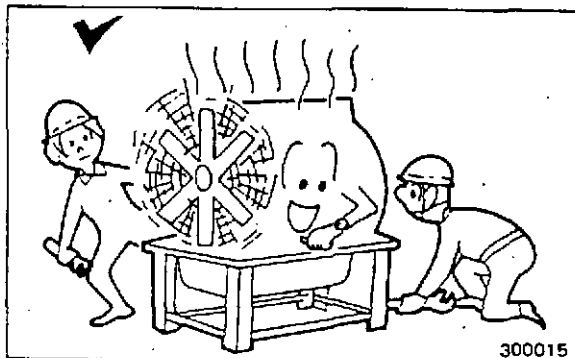

## SAFETY RULES

### After operation

At end of operating period, walk around engine to check for any defects, and make repairs to prepare for the next day.

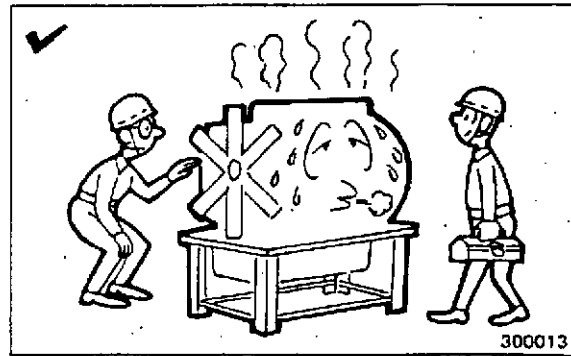

### Maintenance

⚠ Be sure to shut off engine, and turn off battery main switch (or close air tank valve) before servicing engine. If necessary to crank engine for inspection, signal to other man before cranking. After cranking, be sure to lock turning gear.

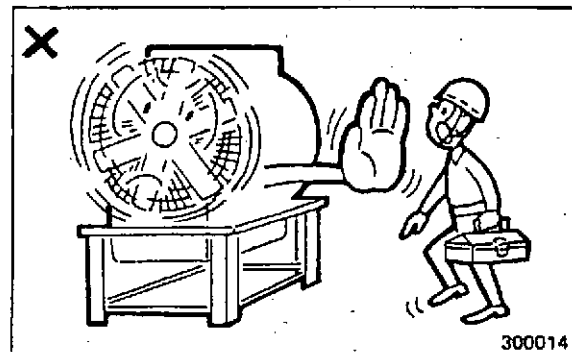

⚠ Use right tools correctly. Thoughtless use of tools including use of a wrong tool can cause personal injury and damage to engine.

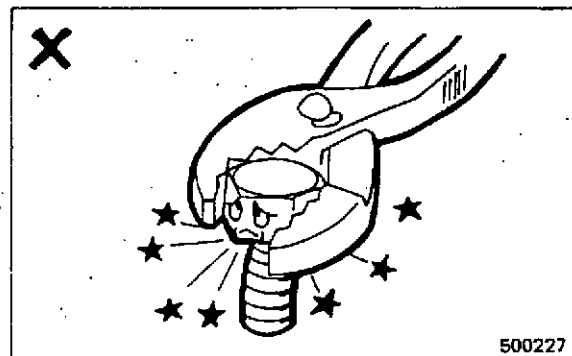

⚠ When removing radiator filler cap immediately after shutting off engine, be sure to release pressure to avoid having scalding by hot water or steam blow out of radiator.

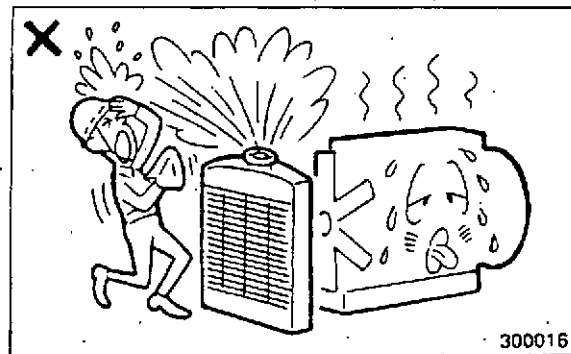

- ⚠ Do not smoke while handling highly flammable materials. Do not use open cans of gasoline or diesel fuel for cleaning parts near any open flame. Good commercial, nonflammable solvents are preferred.

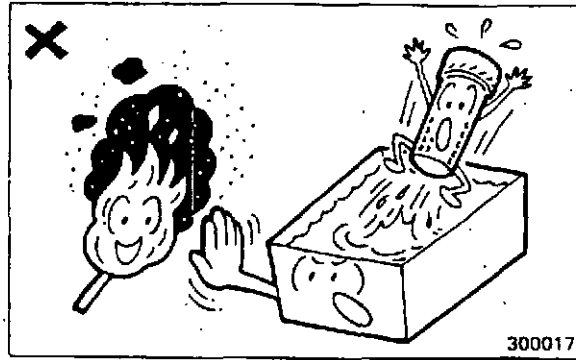

- ⚠ Do not attempt to "climb up" engine for access to upper parts. Use a safe footstool for maintenance without accidents.

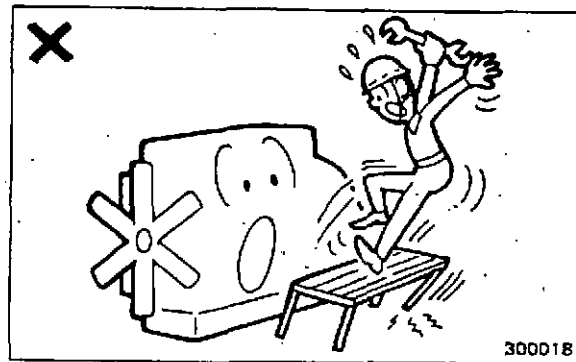

- ⚠ When lifting engine, use slings free of broken strands. Be sure that the hoist has enough capacity for engine to be lifted. Make use of hangers provided on engine, and lift it carefully.

Put wads to sling contacting surfaces of engine to protect both slings and engine.

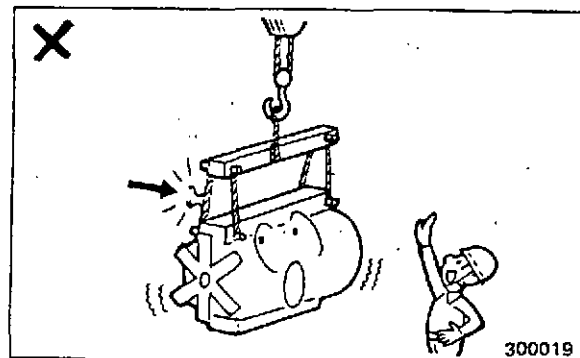

# NOMENCLATURE

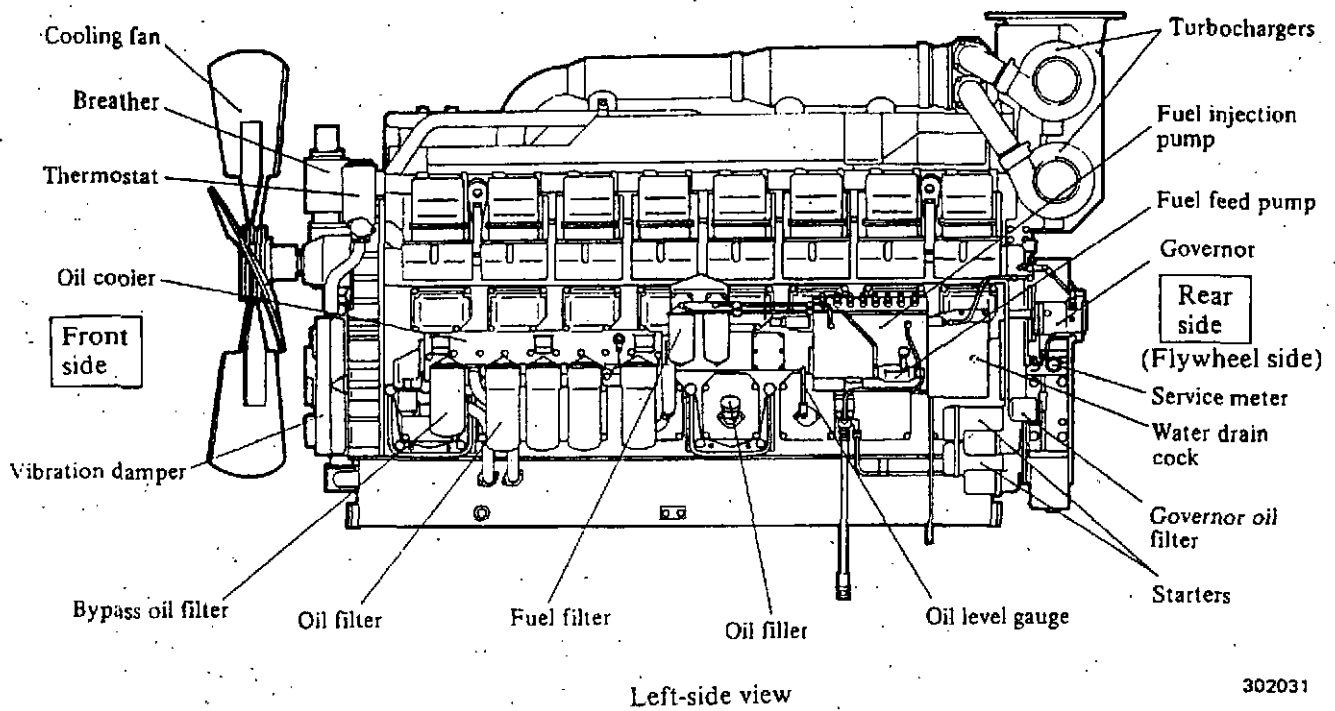

Left-side view

302031

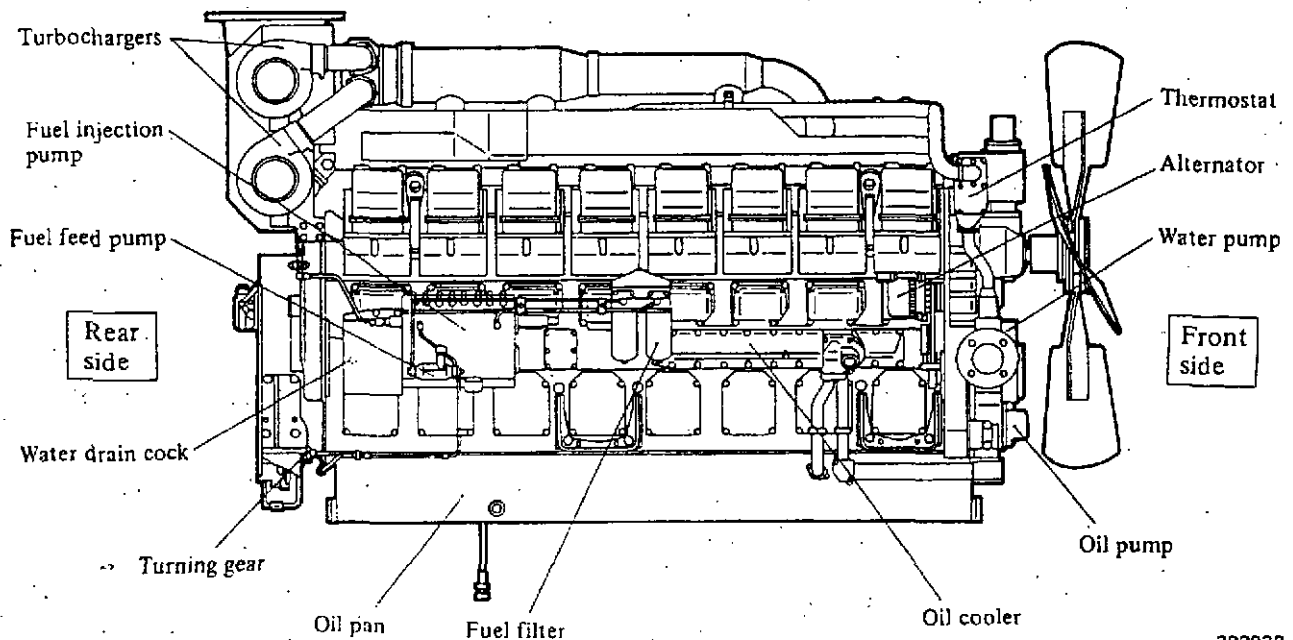

Right-side view

302032

Remarks: Direction of rotation of this engine is counterclockwise as seen from flywheel side.

## OPERATION INSTRUCTIONS

### BEFORE OPERATION

Anyone charged with the care and operation of the engine is responsible for "new engine initial service" — service for a new or reconditioned engine or an engine which has been

stored for a long period of time. Check the following points before starting the engine for the first time. For the second and subsequent services, refer to Maintenance Schedule.

#### Walk-around checks

- Check for damage or missing parts.
- Check for loose bolts or nuts.

#### Cooling system

- Fill cooling system.
- Check for leaks.

#### Fuel system

- Fill fuel tank.
- Prime fuel system.
- Check for leaks.

#### Electrical system

- Check battery electrolyte level and specific gravity.
- Check for loose terminal.
- Check gauges and lamps for operation.

#### Lubrication system

- Fill oil pan.
- Check for oil leaks.

#### Air inlet system

- Check air cleaner for clogging.
- Check gauges and lamps for operation.

After initial 50 service hours, perform the following services:

Change of engine oil

Change of oil filter

Retightening of bolts and nuts

#### CAUTION

During break-in period of a new or reconditioned engine, avoid sudden application of load and high-speed operation for engine life.

## OPERATION INSTRUCTIONS

### WALK-AROUND CHECKS

Damage or missing parts	Engine
Loose bolts and nuts	Cylinder heads
	Crankshaft pulley
	Fuel injection pump couplings and drive shafts
	Mounting brackets
	Turbochargers
	Exhaust pipe

### FUEL SYSTEM

#### Filling fuel tank

Before filling the tank, remove the inspection lid (when so equipped) and check the tank interior for cleanliness. If there is any dirt in the tank, flush the interior by pouring a little fuel into the tank and allowing it to drain from the drain port. Then, fill the tank with recommended fuel. After filling, check the amount of fuel in the tank with level gauge.

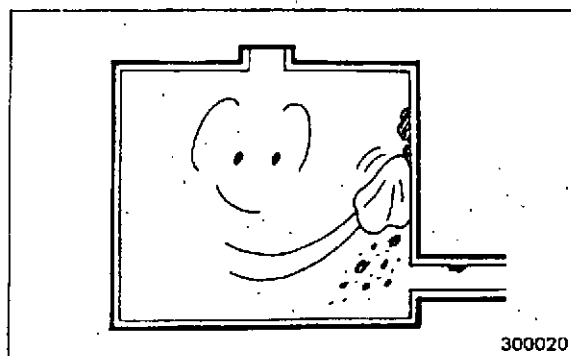

#### Priming fuel system

Prime the fuel filters and injection pumps in that order – that is, from the fuel tank side.

##### • Fuel filters

1. Loosen air vent plugs (1) about 1-1/2 turns on the filter.
2. Unlock priming pump (2) by twisting it counterclockwise and operate it.
3. Tighten plugs (1) when the flow of fuel from the vent plug holes is free of air bubbles.
4. Prime the right-hand and left-hand filters as above.

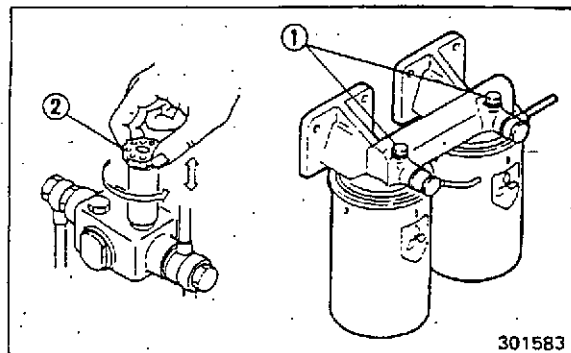

### Fuel injection pumps

1. Loosen air vent plug (3) about 1-1/2 turns on the injection pump.
2. Operate priming pump (2) until the flow of fuel from the plug is free of air bubbles. Lock the priming pump by twisting it clockwise while depressing it, and then tighten vent plug (3).
3. Prime the right-hand and left-hand injection pumps as above.

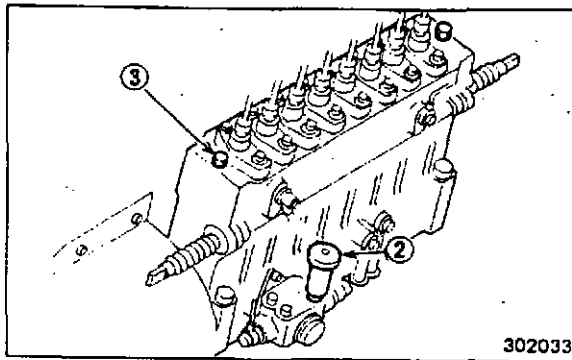

302033

### CAUTION

- If all vent plugs are tightened before priming pump is locked, pressure acts on the feed pump, making it difficult to lock the priming pump.
- Wipe off fuel spilled out of each vent plug hole with wiping rag.

## LUBRICATION SYSTEM

### Filling oil pan

1. Use a clean jug to pour oil into the oil pan. Use engine oil of API service classification "CD."
2. After filling, check the oil level with the level gauge. The level should be within the correct range on the gauge.
3. Remove the rocker covers, and apply oil to the valve mechanism.
4. Check the oil pan and other parts for oil leaks.
5. Start and run the engine for a while. Stop the engine and, after waiting for about 10 minutes, add oil up to the level specified in 2 above.

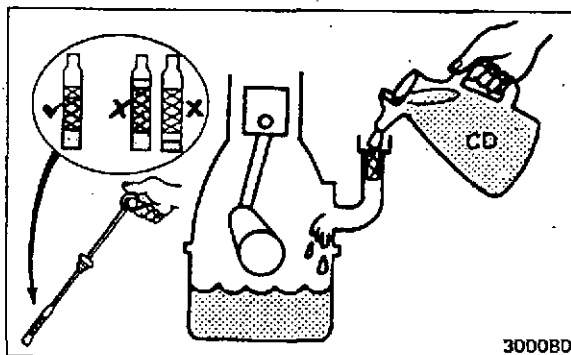

3000B0

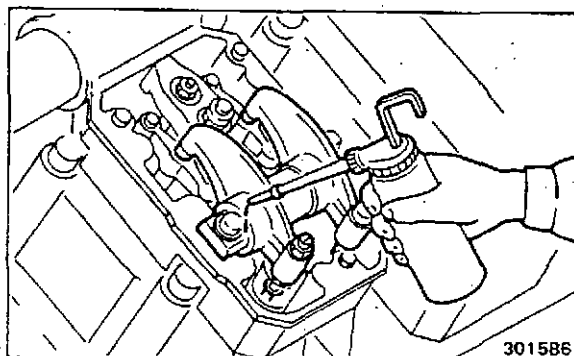

301586

**COOLING SYSTEM**

**Filling cooling system-**

1. Tighten the drain cocks on the rear side of the engine (or the radiator drain plug on a radiator-cooled engine). The engine is shipped from the factory with its cooling system drained.
2. Water used in the cooling system should be soft, or as free as possible from scale forming minerals. Remember, some waters pumped out of ground in a mining or hot-spring area contain such minerals harmful to the material of cylinder liners.

**NOTE**

- 1) Use permanent-type anti-freeze solution of 30% to 50% concentration by volume through the year.
- 2) For coolant freezing temperature vs. anti-freeze solution concentration, see page 38.

3. To fill the cooling system of a radiator-cooled engine for the first time, or to change the coolant in such an engine, proceed as follows:
  - a) Remove the radiator filler cap. Pour anti-freeze solution into the radiator first, then slowly fill the radiator with soft water until it is full.

**CAUTION**

To bleed air out of the cooling system, loosen the valve at the top of thermostat.

- b) When the radiator is full, leave the radiator filler cap removed and crank the engine with the starters three times, for 5 to 6 seconds each time, at intervals of about 20 seconds, in order to bleed air out of the water pump.

**CAUTION**

To crank the engine for air bleeding, keep the stop lever in STOP (returned) position. (See page 15.)

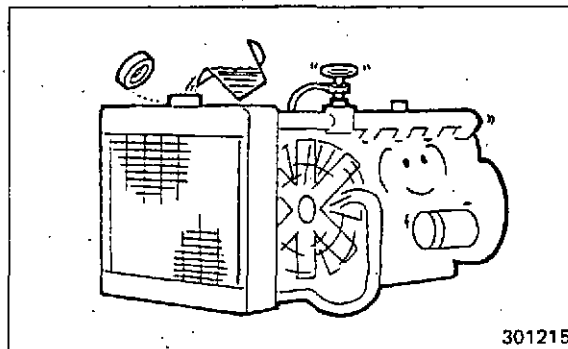
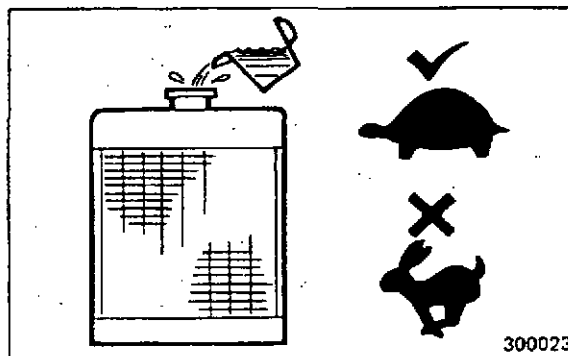

- c) Check the coolant level in the radiator, and add water if necessary.
- d) Crank the engine with the fuel supply shut off for 10 seconds to make sure that the oil pressure rises normally. If the pressure does not rise in 10 seconds, wait for about 1 minute, and crank it again.
- e) Start the engine and run it at 600 rpm until the normal operating temperature is reached to mix the anti-freeze solution and water.
- f) Stop the engine, and check the coolant level in the radiator again. If the level is low, refill the radiator fully, and install the cap.

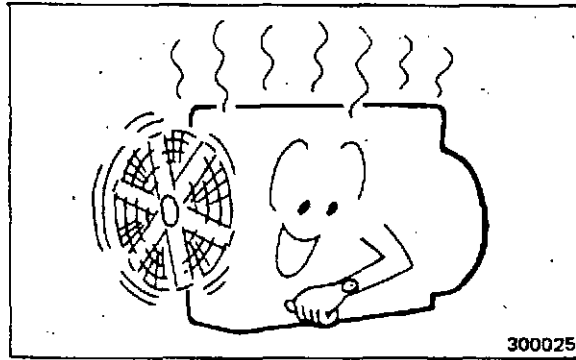

**NOTE**

When refilling the radiator, maintain the recommended anti-freeze concentration.

- g) Check the hose joints for coolant leaks.

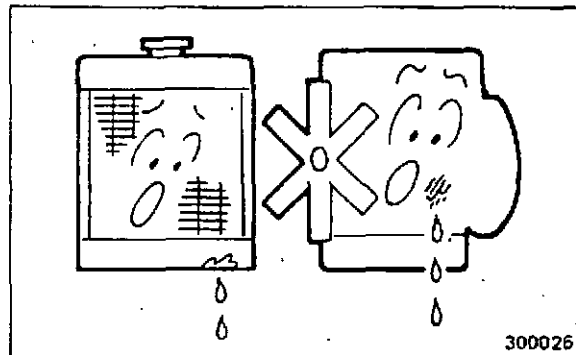

**ELECTRICAL SYSTEM**

**Checking battery electrolyte level**

1. Remove the filler caps, and check the electrolyte level in each cell. It should be 1 cm (0.4 in.) above the cell plates.
2. When filling the cells of the battery for the first time, slowly pour dilute sulfuric acid (electrolyte) in the cells.
3. If the battery is already filled with electrolyte, check its level and, if the level is low, add distilled water.

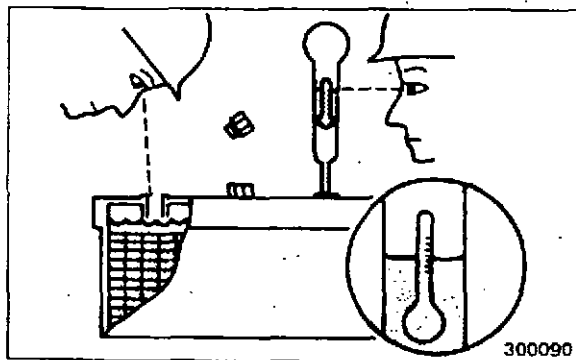

**Checking electrolyte specific gravity**

Check the specific gravity of electrolyte. If the SG is below 1.22 at 20°C (68°F), recharge the battery.

**Circuits**

Check each circuit for loose terminals.

**WARNING**

- Electrolyte, sulfuric acid, is very corrosive. If you drip it on your skin or clothing, flush it off at once with water.
- Do not allow sparks or open flame near the battery.

## OPERATION INSTRUCTIONS

### OTHERS

Check the following valves and cocks to make sure they are opened or closed properly:

- Fuel supply valve ..... Open
- Radiator coolant drain cock  
(radiator-cooled engine) ..... Closed
- Coolant drain cock (engine) ..... Closed
- Oil drain valve ..... Closed
- Air supply valve (air tank) ..... Open

OPERATING THE ENGINE

Instruments

**• Water temperature gauge**  
Indicates temperature of engine coolant.  
Normal range:  
70 to 90°C  
(158 to 194°F)

**• Oil filter alarm lamp (pilot lamp)**  
Glows when oil filter element is clogged.

**• Tachometer**  
Indicates engine speed in rpm (revolutions per minute).

**• Oil temperature gauge**  
Indicates temperature of engine lubricating oil.  
Normal range:  
70 to 110°C  
(158 to 230°F)

**• Oil pressure gauge**  
Indicates pressure of lubricating oil.  
Normal range:  
5 to 6.5 kgf/cm<sup>2</sup>  
(71 to 92 psi)  
(0.5 to 0.6 MPa)

**• Ammeter**  
Indicates battery charging current.  
Normal indication: (+) side

**• Starter switch**  
HEAT: Operates air heater (when so equipped) to start engine easily in cold weather. (engine with air heater)  
OFF: Insert and pull out key. All electrical circuits are OFF. Turn the key to this position to stop the engine.  
ON: Keep engine running. Charging and lamp circuits are ON.  
START: Start engine. Key will return to ON when released.

300921

Controls

**• Speed control lever**

300082

Use the lever to control engine speed. Pull it to stop engine.

**• Stop lever**

301159

Pull the lever to stop a generator drive engine in case of emergency.

**• Service meter**

301587

Rely on this meter to check; service or lubricate engine.

NOTE: Dial advances one number when engine is operated for 1 hour at 1500 rpm.

## OPERATION INSTRUCTIONS

After performing daily (10-hour) servicing, operate the engine as follows:

### STARTING

There are three methods available for starting the engine. — electric starting, air motor starting and air starting. Disengage the clutch (when so equipped) or remove any load from the engine.

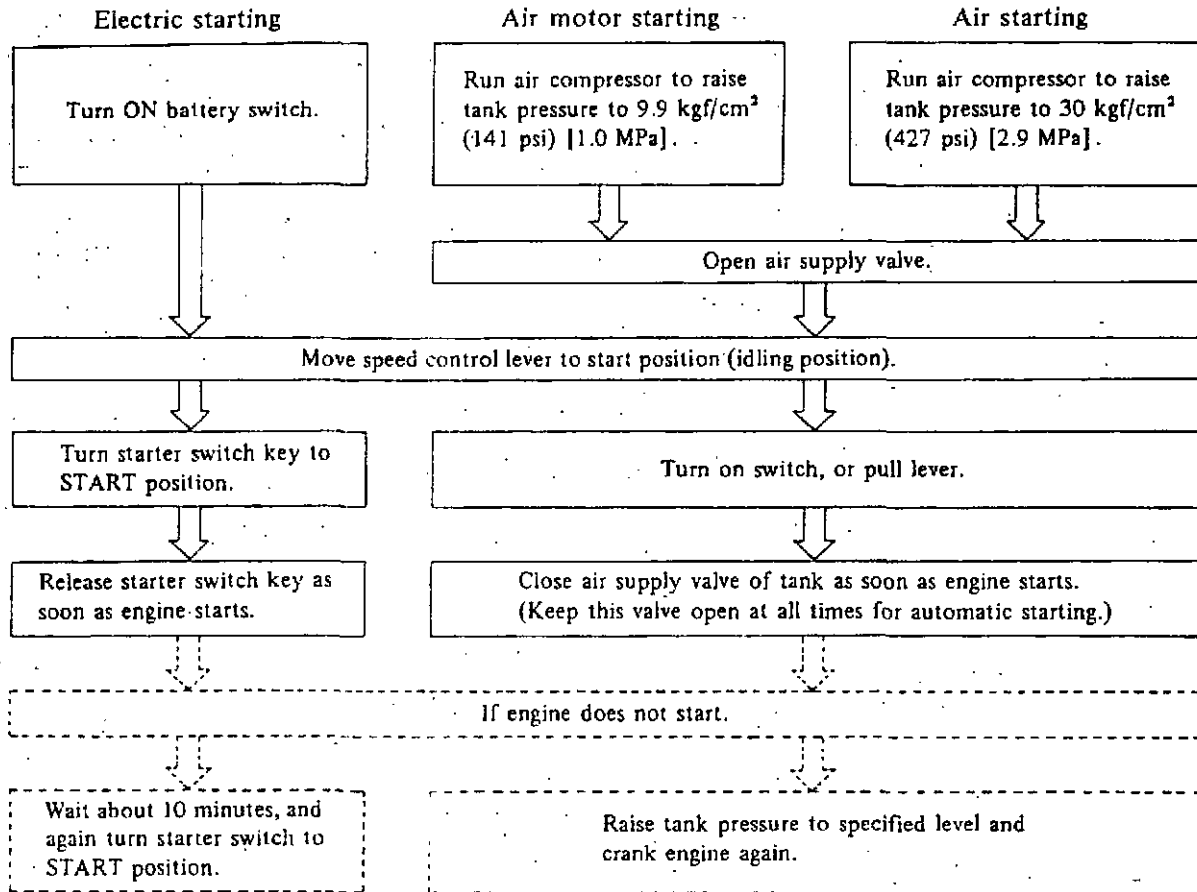

### CAUTION

- Do not crank the engine for more than 10 seconds at any one time. This may cause the battery to run down.
- Never attempt to turn the starter switch and battery switch to OFF position when the engine is running.
- In case of air motor starting or air starting engine, open the air tank drain cock and drain water every 50 hours or monthly.

**WARMING UP**

After starting up, allow the engine to idle at about 1000 rpm for 5 minutes to warm it up. During this warm-up period, check to be sure that oil pressure rises properly. The pressure will be 2 to 3 kgf/cm<sup>2</sup> (28 to 43 psi) [0.2 to 0.3 MPa] during low idling.

The pressure will be sometimes higher than the standard level – 5 to 6.5 kgf/cm<sup>2</sup> (71 to 92 psi) [0.5 to 0.6 MPa] if the engine is revved up immediately after it has been started, that is, when the oil temperature is low. The pressure will become normal as the oil temperature rises.

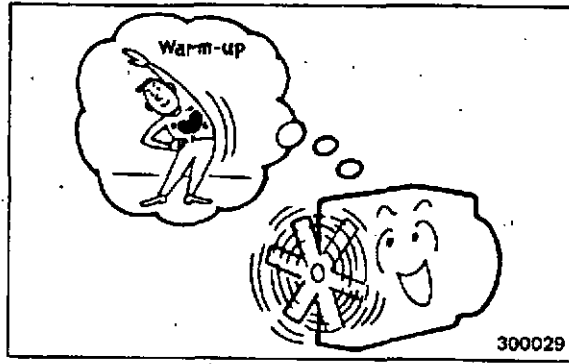

**CAUTION**

It is not necessary to warm up a stand-by engine. Instead, be sure to perform periodical testing items described in "Maintenance Instructions."

**STARTING THE LOAD**

After warming up the engine, apply the load. During the operation, check to be sure –

1. The engine makes no abnormal sound and vibration.
2. Exhaust smoke color is normal.
3. There is no fuel, coolant or oil leakage.
4. Meters and gauges are indicating normally.

- Tachometer
- Engine oil pressure gauge: 5 to 6.5 kgf/cm<sup>2</sup> (71 to 92 psi) [0.5 to 0.6 MPa]
- Water temperature gauge: 70°C to 90°C (158°F to 194°F)
- Ammeter: (+) side
- Engine oil temperature gauge: 70°C to 110°C (158°F to 230°F)
- Oil filter alarm lamp (pilot lamp): OFF

**STOPPING**

1. After the load is removed, allow the engine to idle for 5 or 6 minutes.
2. Shutting off the engine immediately after removing the load is very hard on the engine parts.

**CAUTION**

Keep on pulling the stop lever until the engine stops "rocking" to prevent it from turning in reverse direction.

Engine equipped with speed control lever

Move speed control lever to STOP position.

Engine equipped with stop lever

Pull stop lever on governor to STOP position.

Turn starter switch to OFF position, pull out the key, and turn OFF battery switch (electric starting).

## MAINTENANCE INSTRUCTIONS

1. Use service-meter or calendar intervals whichever occur first.
2. The maintenance schedule, which follows, is for a fully equipped engine.
3. The established intervals in the schedule are for an average job application. Service the engine earlier than scheduled intervals if necessary. (Service intervals depends on application, operating conditions, fuel oil and lube oil used in the engine. Adjust the service intervals to meet the actual operating conditions.)
4. Perform previous interval items at multiples of the original requirement.

Example:

At 250 hours or 1 year, also perform those items listed in "10 hours or daily" and "50 hours or monthly."

5. Where the engine is used for stand-by duty,

it must be thoroughly checked and kept in perfectly operable condition at all times. This is because it has to be started and run under severe conditions and is expected to give full performance no matter when it is put in operation. Test the engine periodically by running it in no-load condition, as follows:

Test run	Once-a-week no-load test run for 5 to 10 minutes	Check for: Ease of starting Lube oil pressure Color of exhaust smoke Abnormal vibration and others
	Once-a-month load test run for 15 to 30 minutes (Operate at half the full load, min.)	

- : Check, clean, wash, adjust.
- : Change.
- Ⓢ : Rely on your Mitsubishi dealer if necessary.
- \* : Item to be performed on a new, reconditioned or long-stored engine for the first time.

### MAINTENANCE SCHEDULE

Group	Service		Service intervals					Remarks	
			Every 10 hours or daily	Every 50 hours or monthly	Every 250 hours or 1 year	Every 500 hours or 2 years	Every 1000 hours or 3 years		Every 2000 hours or 5 years
Engine	Valve clearance	Check			*		○		Ⓢ
	Bolts and nuts	Retighten		*			○		Ⓢ
	Walk-around checks		○						
Lubrication system	Oil pan	Check oil level	○						
		Check for water or fuel in oil		○					
		Change oil		*	●				Ⓢ
	Oil filters	Change		*	●				Also change when filter alarm lamp glows
	Bypass oil filter	Change			●				Ⓢ
	Governor oil filter	Change				●			

MAINTENANCE INSTRUCTIONS

Group	Service		Service intervals						Remarks	
			Every 10 hours or daily	Every 50 hours or monthly	Every 250 hours or 1 year	Every 500 hours or 2 years	Every 1000 hours or 3 years	Every 2000 hours or 5 years		
Fuel system	Fuel tank	Check oil level	○							
		Drain water		○						
	Fuel filters	Change				●		③		
	Injection nozzles	Check and adjust					○		③	
	Injection timing	Check and adjust					○		③	
Cooling system	Coolant	Check level	○							
		Change	Every 1 year							
	Radiator fins	Clean			○				③	
	Friction rubbers	Check			○					
	Heat exchanger	Wash						○	③	
	Zinc rods	Change				●			③	
Air inlet and exhaust systems	Air cleaner (paper-element type)	Check indicator	○							
		Clean element			○				③	
		Change element					●			
	Air cleaner (silencer type)	Clean			○				③	
	Exhaust muffler	Drain water			○					
	Air cooler	Clean						○	③	
	Turbochargers	Check						○	③	
Starting system	Electric starting	Batteries	○						Check specific gravity from time to time	
		Alternator	Check					○	③	
		Starters	Check					○	③	
	Air starting	Oiler	Check oil level	○						
		Air filter (air-motor engine)	Drain water		○					
			Wash element				○			③
		Air filter (air-start engine)	Drain water		○					
	Wash element				○			③		

MAINTENANCE INSTRUCTIONS

Group	Service		Service intervals					Remarks		
			Every 10 hours or daily	Every 50 hours or monthly	Every 250 hours or 1 year	Every 500 hours or 2 years	Every 1000 hours or 3 years		Every 2000 hours or 5 years	
Starting system	Air starting	Air tank	Check air pressure	○						Before starting
			Drain water		○					
			Check safety valve for operation			○				
Protective devices operation	Water temperature rise: $98 \pm 2^{\circ}\text{C}$ ( $208.4 \pm 3.6^{\circ}\text{F}$ ) Engine oil pressure drop, $\text{kgf/cm}^2$ (psi) [kPa]: - At rated speed, $4 \pm 0.2$ ( $57 \pm 2.8$ ) [ $392 \pm 17$ ] - At idle speed, $1.5 \pm 0.075$ ( $21 \pm 1.1$ ) [ $147 \pm 7.4$ ] Overspeeding: 112 to 115%						○		⑤ Check when malfunction is suspected. (Check for stand-by engine every 1 year.)	
Others	Vibration damper	Check						○		Leaks, cracks in rubber or flaw
		Change								Every 8000 hours
	Coupling (rubber bushings)	Check			○					⑤ Cracks or other defects
	Valves in pipeline	Check for setting	○							
	Speed control lever	Check	○							
	Alternator drive belt	Check tension			○					

EVERY 10 HOURS OR DAILY

Walk-around checks

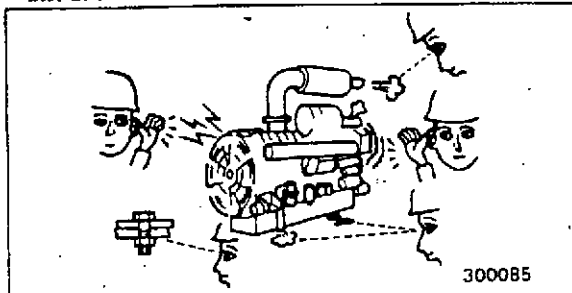

300085

Check for:

- Loose or missing bolts and nuts
- Abnormal vibration, noise and exhaust color
- Water, oil, air and gas leaks
- Broken electric wire and loose terminals
- Loose pipe joints
- The amount and color of mist from breather

Radiator – Check coolant level.

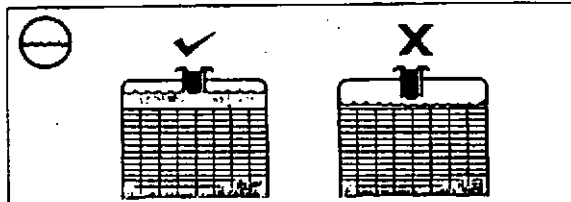

300160

Remove radiator filler cap and check. Coolant should be visible in filler neck. Check level in sight gauge on expansion tank when so equipped. Add coolant containing antifreeze of the prescribed concentration to radiator or tank if coolant level is low.

Oil pan – Check oil level.

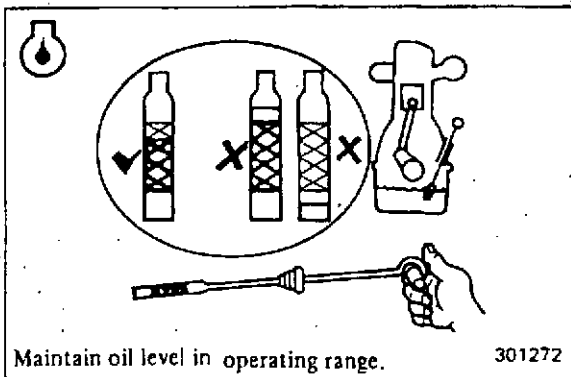

301272

Maintain oil level in operating range.

Air cleaner indicator (paper-element type) – Check.

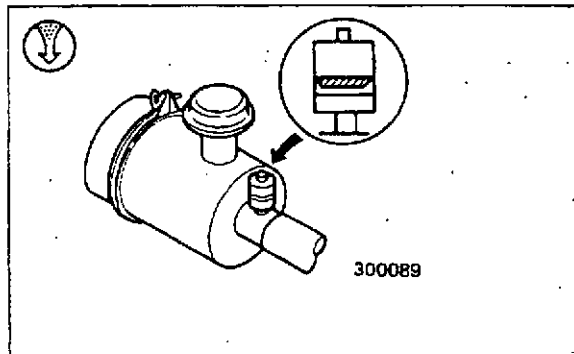

300089

Fuel tank – Check level.

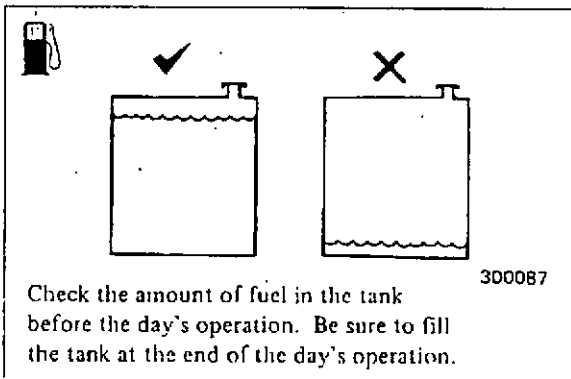

300087

Check the amount of fuel in the tank before the day's operation. Be sure to fill the tank at the end of the day's operation.

MAINTENANCE INSTRUCTIONS

EVERY 10 HOURS OR DAILY – continued

**Battery** – Check electrolyte level and specific gravity.

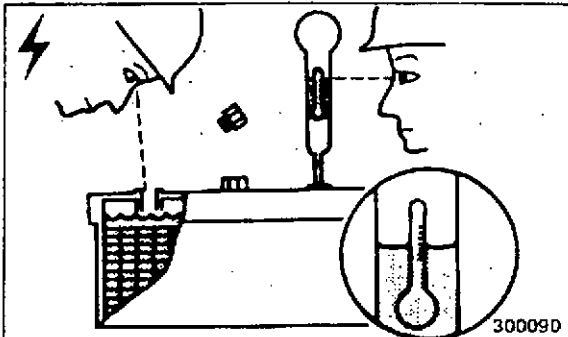

Electrolyte level should be 1 cm (3/8 in.) above cell plates.  
Check specific gravity from time to time, and recharge before it drops to 1.22.

**Valves in pipeline** – Check for setting.

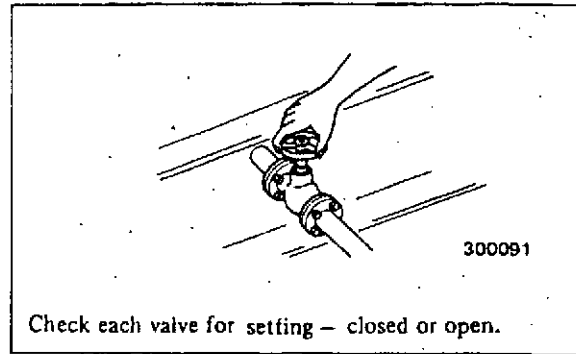

Check each valve for setting – closed or open.

**Oiler (air-motor engine)** – Check oil level.

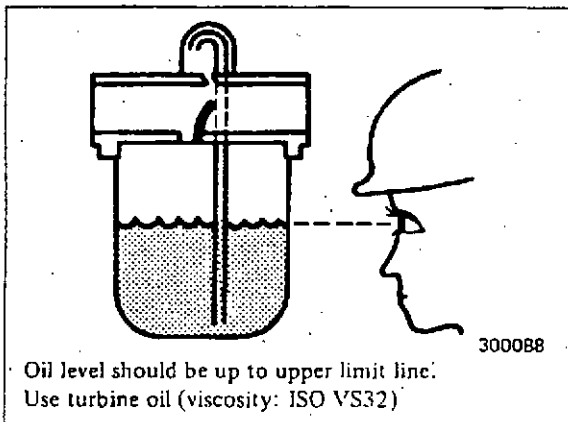

Oil level should be up to upper limit line.  
Use turbine oil (viscosity: ISO VS32)

**Speed control lever** – Check.

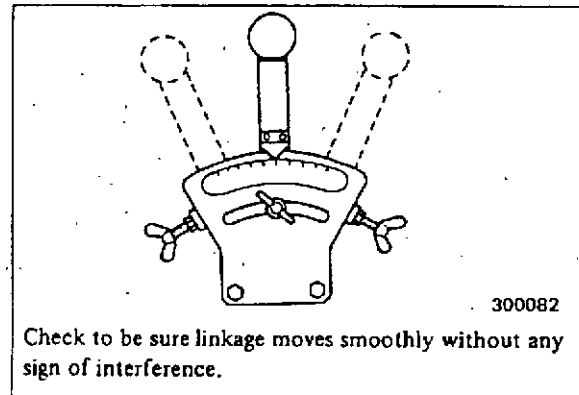

Check to be sure linkage moves smoothly without any sign of interference.

**Air tank (air-motor/air-start engine)** – Check air pressure.

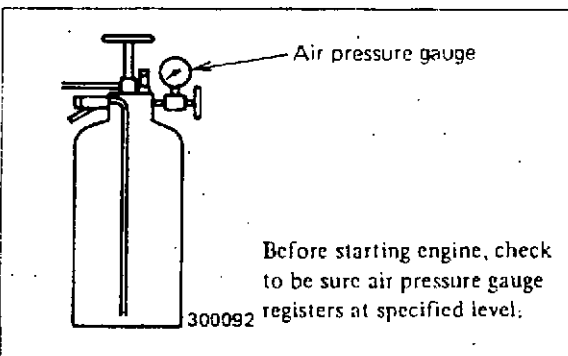

Before starting engine, check to be sure air pressure gauge registers at specified level.

EVERY 50 HOURS OR MONTHLY

Oil pan – Check for water or fuel in oil.

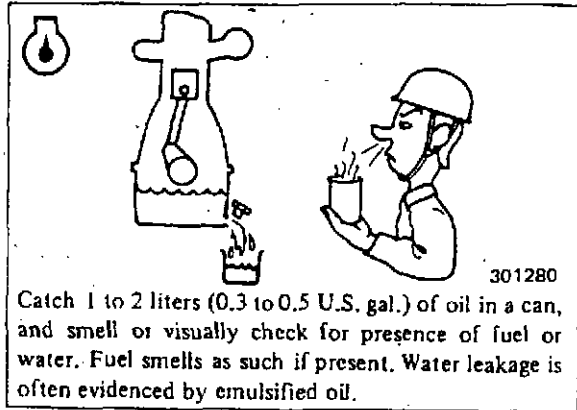

Air filter (air-start engine) – Drain water.

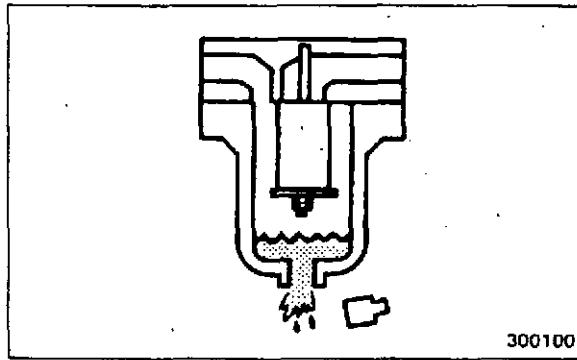

Fuel tank – Drain water.

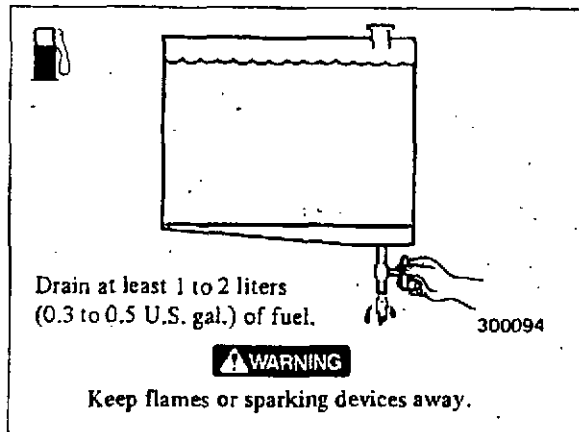

Air tank (air-motor/air-start engine) – Drain water.

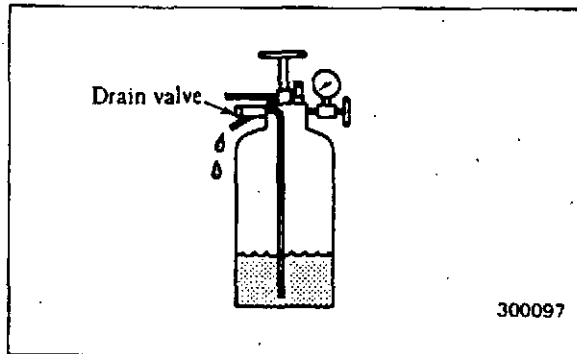

Air filter (air-motor engine) – Drain water.

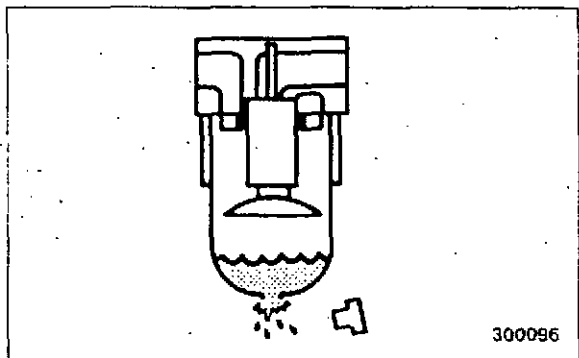

## EVERY 1 YEAR

### Changing the coolant



1. Normally, change coolant every 1 year.
2. Use clean water that is soft, or as free as possible from scale forming minerals.
3. Use permanent-type anti-freeze solution through the year within a concentration range of 30% to 50% by volume to provide freeze protection. Anti-freeze solution of less than 30% concentration does not provide sufficient corrosion protection. Concentrations over 50% adversely affect freeze protection and heat transfer rate, resulting in freezing or overheating.

#### NOTE

- 1) Determine concentration of anti-freeze solution on the basis of cooling system capacity.
- 2) When refilling the cooling system, use anti-freeze solution of the same concentration as before.

Temperature, °C (°F)	Above -11 (12)	Above -15 (5)	Above -19 (-2)	Above -25 (-13)	Above -31 (-24)
Recommended antifreeze concentration, % by volume	30	35	40	45	50
Amount of water, % by volume	70	65	60	55	50

#### Procedure

1. Start engine and run it until coolant temperature is 70°C to 90°C (158°F to 194°F).
2. Raise lever of radiator filler cap (1) to relieve pressure and remove the cap.
3. Open radiator drain plug (2) and drain cocks (3) on the right and left sides of engine, and drain coolant.
4. Close drain cocks and fill cooling system with flushing solvent (which does not attack rubber and metal). Run engine at 800 to 900 rpm for about 15 minutes. Stop engine and drain flushing solvent.
5. Close drain cocks. Fill cooling system with clean water and run engine at 800 to 900 rpm for about 10 minutes.
6. Stop engine and open drain cocks. Rinse cooling system with clean water until water flowing out of engine is clean.
7. Close drain plug and cocks, and fill cooling system with soft water up to specified level.
8. Start engine and run it until coolant temperature is 70°C to 90°C (158°F to 194°F). Stop engine and check coolant level in radiator. Add coolant if necessary.

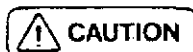

Loosen air vent valve at the top of thermostat case to bleed air completely.

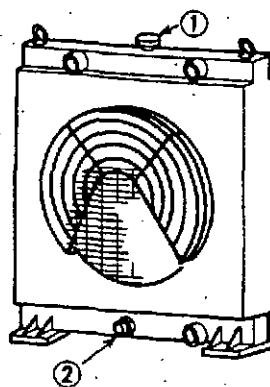

300102

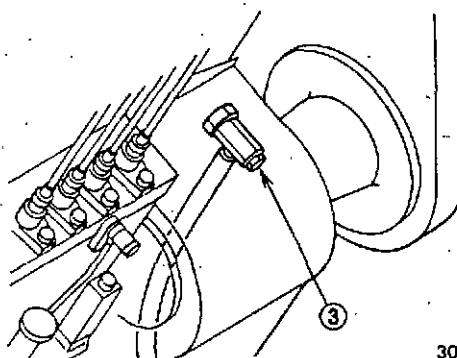

301592

EVERY 250 HOURS OR 1 YEAR

Oil pan – Change oil.

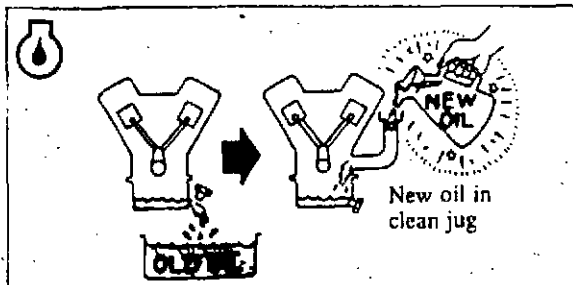

301597

Drain out oil when engine is still hot shortly after operation. Use engine oil of API service classification "CD" (for high-speed, high-load, turbo-charged diesel engines).

Friction rubbers – Check.

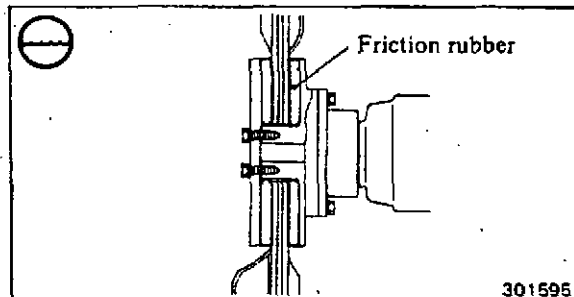

301595

Visually check for deterioration or cracks.

Oil filters and bypass oil filter – Change.

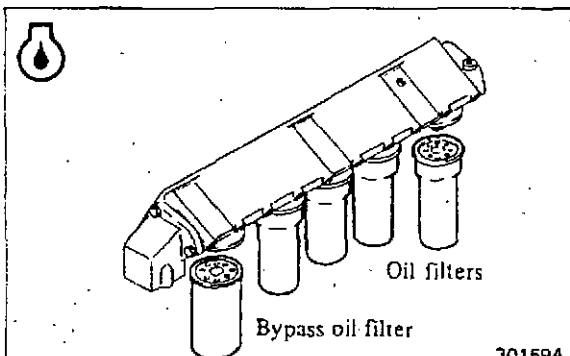

301594

Disassemble filter and check for metal particles trapped in it. If such particles are found, consult your Mitsubishi dealer.

**NOTE**

Also change filter when oil filter alarm lamp glows.

Air cleaner – Clean element.

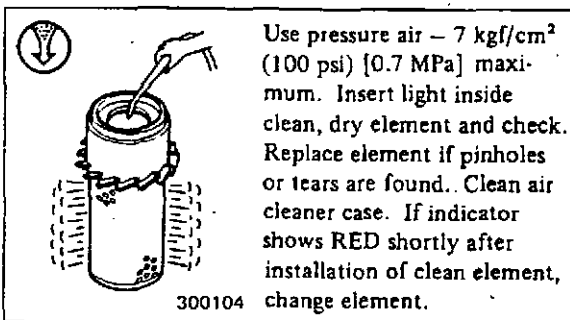

Use pressure air – 7 kgf/cm<sup>2</sup> (100 psi) [0.7 MPa] maximum. Insert light inside clean, dry element and check. Replace element if pinholes or tears are found. Clean air cleaner case. If indicator shows RED shortly after installation of clean element, change element.

Silencer – Clean.

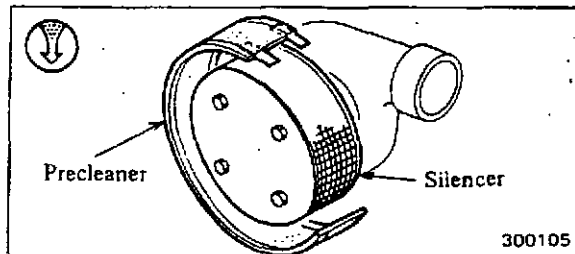

300105

Remove precleaner, and wash it with neutral cleaning solvent.

Radiator fins – Clean

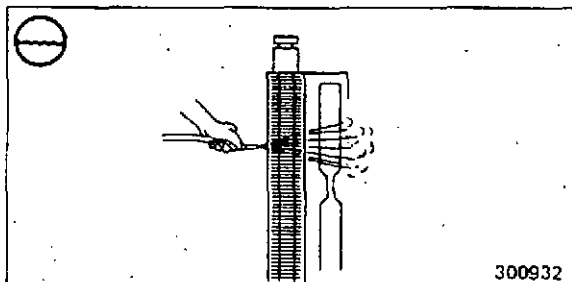

300932

Direct pressure air in direction opposite to air flow.

EVERY 250 HOURS OR 1 YEAR – continued

Exhaust muffler – Drain water.

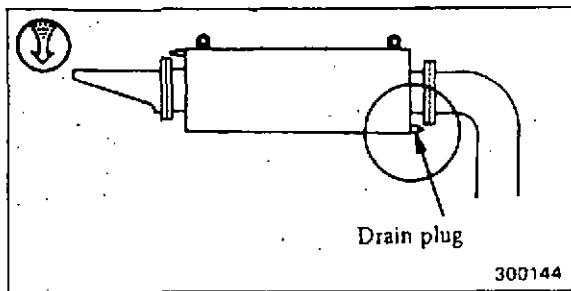

Air tank (air-motor/air-start engine) – Check safety valve for operation.

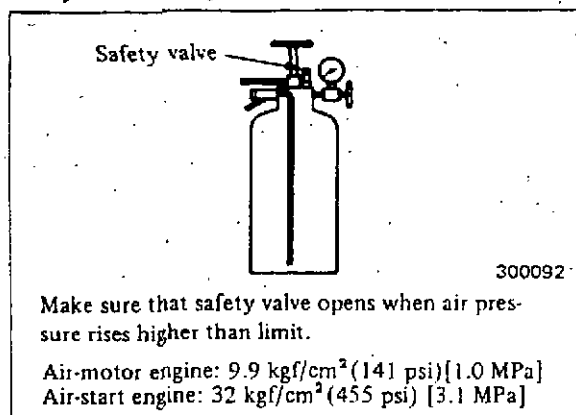

Make sure that safety valve opens when air pressure rises higher than limit.

Air-motor engine: 9.9 kgf/cm<sup>2</sup> (141 psi) [1.0 MPa]  
Air-start engine: 32 kgf/cm<sup>2</sup> (455 psi) [3.1 MPa]

Coupling (rubber-bushing type) – Check.

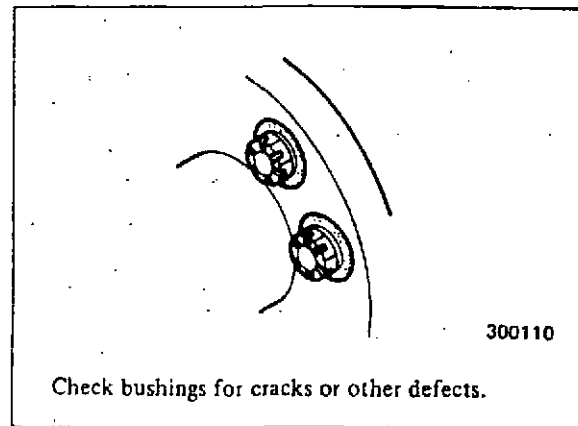

Alternator drive belt – Check tension.

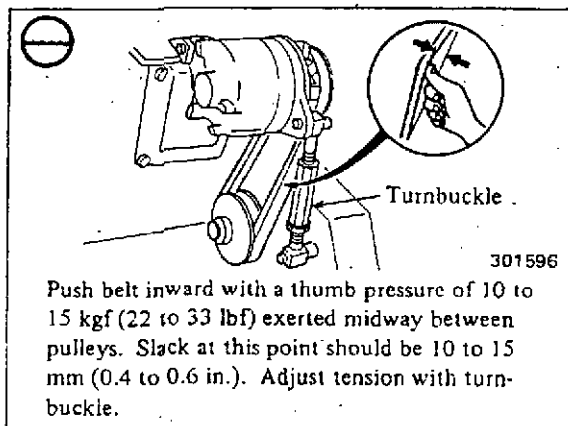

EVERY 500 HOURS OR 2 YEARS

Governor oil filter (Woodward type) – Change.

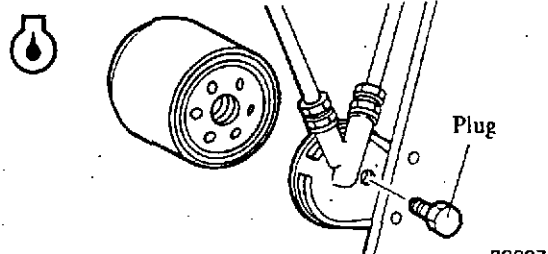

302071

Do not wash filter. Be sure to change it with a new one.

**NOTE** After installing a new filter, remove plug from filter bracket and pour engine oil into filter until it is full.

Air filter (air-motor engine) – Wash element.

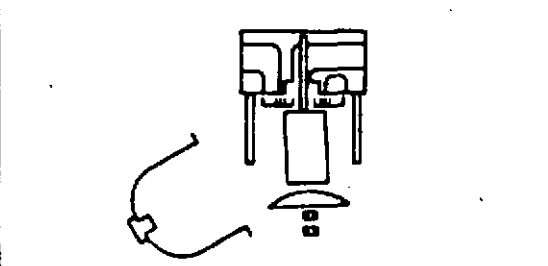

300115

Wash element with diesel fuel.

Zinc rods (sea-water cooling) – Change.

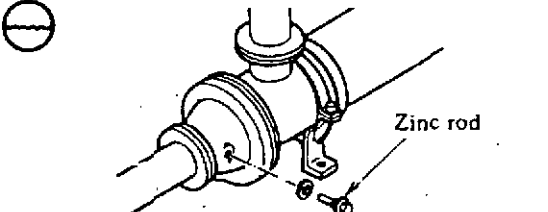

300113

Change zinc rods of heat exchanger, air coolers, etc.

Air filter (air-start engine) – Wash element.

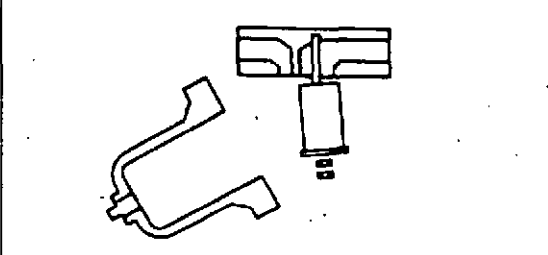

300116

Wash element with diesel fuel.

EVERY 1000 HOURS OR 3 YEARS

Bolts and nuts – Retighten.

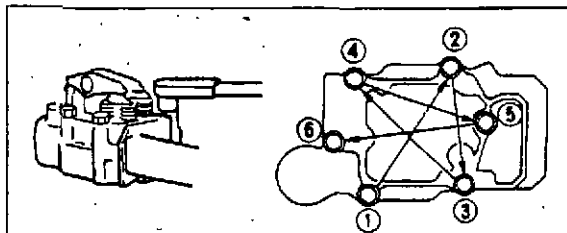

301172

Retighten bolts and nuts on:

- Timing gear case
- Crankshaft pulley
- Injection pump coupling and shaft
- Mounting brackets
- Exhaust manifolds
- Turbochargers

Retighten cylinder head bolts in sequence shown above.

Fuel injection nozzles – Check and adjust.

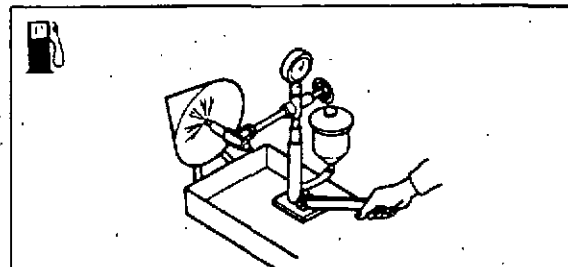

300150

Injection pressure: 350 kg/cm<sup>2</sup> (4977 psi)  
[34.3 MPa]

Make sure that nozzle produces a conical, somewhat hollow spray with finely atomized fringe, issuing from ten orifices.

**NOTE** If exhaust smoke is abnormal, check nozzles for spray pattern. See Fuel Injection Nozzles – Check and adjust.

Fuel filters – Change.

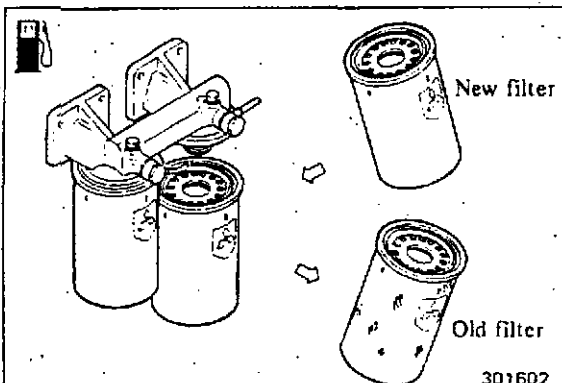

301602

Apply oil to gasket of a new cartridge. Bring gasket into contact with sealing face of bracket, and tighten cartridge 1/2 to 3/4 rotation by hands.

Air cleaner – Change element.

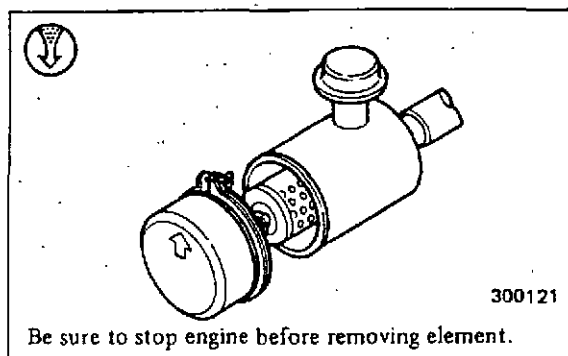

300121

Be sure to stop engine before removing element.

EVERY 1000 HOURS OR 3 YEARS – continued

Injection timing – Check and adjust.

To adjust injection timing, proceed as follows:

1. Injection timing is indicated on caution plate attached to rocker cover

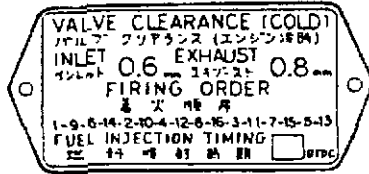

302034

2. Using a turning gear, turn crankshaft in normal direction (clockwise as seen from front side), bringing timing pointer into alignment with 1, 8 index number mark punched on damper. This crank position corresponds to top dead center on compression stroke in No. 1 cylinder. Make sure that inlet and exhaust valves of No. 1 cylinder have some clearance. If they have no clearance, turn crankshaft once more.

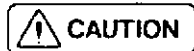

Be careful not to confuse No. 1 cylinder with No. 8. When No. 1 is in the above-mentioned position, its inlet and exhaust valves are both fully seated, presenting valve clearance.

3. Turn back crankshaft about 60°, and turn it forward slowly until timing mark (2) on pump coupling aligns with pointer (1) on end face of pump case. In this position of crankshaft, read degrees of angle (injection timing) on scale (4) provided on damper, indicated by pointer (3). Minus (-) mark on scale means BEFORE top dead center.

4. To adjust injection timing, proceed as follows:

Make sure that pointer is aligned with injection timing mark for No. 1 cylinder on damper, displace injection pump by loosening two coupling bolts (5) to align pointer (1) on pump case with timing mark (2) on pump coupling. Then, tighten one bolt and, after turning crankshaft, tighten another. Again check injection timing by cranking engine.

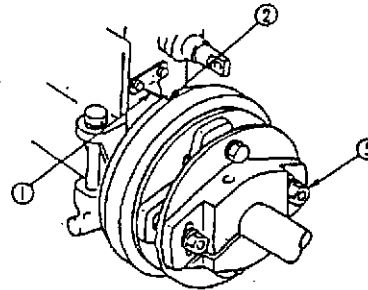

302035

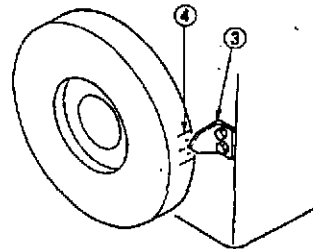

302036

5. On left-hand injection pump, the position where pointer aligns with index number – 9, 16 – on damper is top dead center on compression stroke of No. 9 cylinder. At this position, both inlet and exhaust valves of that cylinder must have clearance as specified. After this, follow procedure outlined for right-hand side injection pump.

Fuel injection nozzles – Check and adjust.

Removal

1. Remove nozzle connector (1) by loosening securing nut.
2. Unscrew gland nut (2) and, after taking off gland, remove nozzle from cylinder head.
3. To remove nozzle, use nozzle remover (3) (33591-10101).

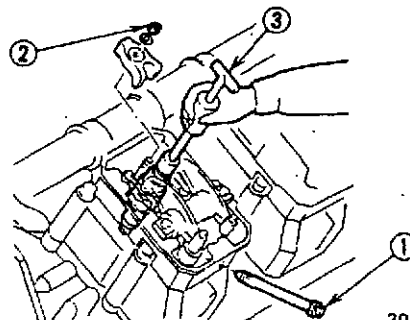

301605

EVERY 1000 HOURS OR 3 YEARS – continued

**Injection pressure adjustment**

1. Mount injection nozzle in a tester. Push down tester lever gently to pressurize. See if fuel spray begins at 350 kgf/cm<sup>2</sup> (4977 psi) [34.3 MPa].
2. Remove cap nut (4) on nozzle holder, and tighten or loosen adjusting screw (5). Tightening screw will increase pressure, and vice versa.
3. After adjusting, put back on cap nut (4) and tighten it to 4 to 5 kgf-m (29 to 36 lbf-ft) [39 to 49 N-m].

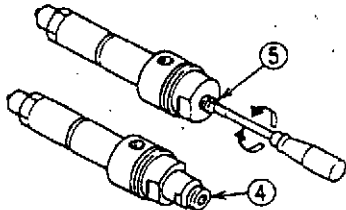

300212

5. Tighten cap nut (6) to 18 to 20 kgf-m (130 to 145 lbf-ft) [177 to 196 N-m].
6. If the foregoing adjustment and cleaning do not improve spray pattern, replace nozzle tip.

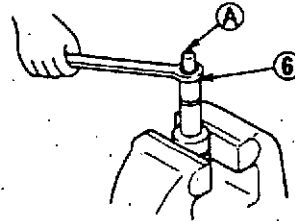

300123

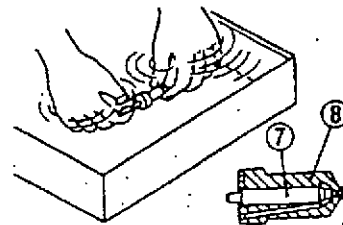

400229

**Fuel spray pattern**

1. Push down tester lever forcefully to let nozzle spray fuel. Spray should occur from all of the ten orifices at the same time, taking a cone shape with an angle of 160 degrees and consisting of finely and uniformly atomized fuel particles. Nozzle should terminate each spray without any after-dribble.
2. If spray pattern is poor, remove nozzle tip. To remove the tip, remove cap nut (4), loosen adjusting screw (5) with a screwdriver, and loosen retaining nut (6). Be sure to follow these steps in order because the tip is spring-loaded.
3. Wash needle valve (7) and body (8).

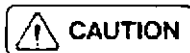

**CAUTION**  
When removing nozzle tip, be careful not to tap part (A) of the tip.

4. For cleaning fluid, use clean gasoline. After cleaning, assemble needle valve (7) and body (8) in clean diesel fuel.

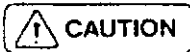

**CAUTION**  
Needle valve and body are selectively fitted: never change this combination by replacing either part.

**Installation**

1. To install, use reverse of removal procedure. To install nozzle, tighten nut to 10 kgf-m (72.3 lbf-ft) [98 N-m] while keeping the gap between body and spring equally. After installing nozzle, check each fuel pipe joints for fuel leaks.
2. Remove rocker cover, and run engine at about 600 rpm. Under this condition, check to be sure that no fuel leaks at points (A), (B) and (C). Then, stop engine, and install rocker cover.

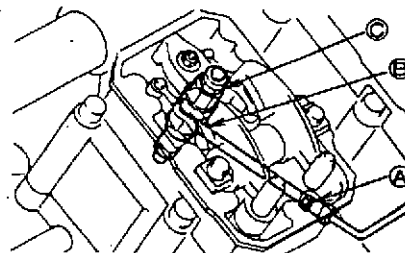

301605

EVERY 1000 HOURS OR 3 YEARS — continued

Valve clearance — Check.

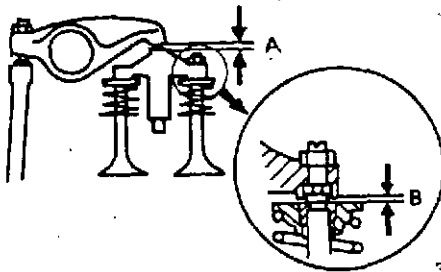

300516

Unit: mm (in.)

	Valve clearance (A) (cold)	Bridge-to-valve rotator clearance (B)
Inlet valves	0.6 (0.024)	1.5 (0.059), minimum
Exhaust valves	0.8 (0.031)	

Check valve clearance in sequence of firing order (injection sequence) shown below by turning crankshaft with turning gear.

Firing order

1-9-6-14-2-10-4-12-8-16-3-11-7-15-5-13

Adjust valve clearance if it is incorrect.

**NOTE** Inlet valves are on left side and exhaust valves on right side of each cylinder head as seen from right or left side of engine.

Valve clearance — Adjust.

Valve height adjustment

1. Before adjusting valve clearance, adjust heights of two valves (bring bridge into contact with valves). If valve seats are worn, one valve differs from the other in height, producing some clearance between its stem top (5) and bridge (3) to change valve clearance.
2. To adjust, loosen lock nut (2) and back off adjusting screw (1).
3. Hold rocker arm by finger in such a manner as to push down on bridge (3) and turn in adjusting screw (1) until it touches valve stem top (5). From this position, further turn it in about 10° turn and tighten lock nut (2).

3. After obtaining a proper clearance, set adjusting screw (6) by tightening lock nut (7).

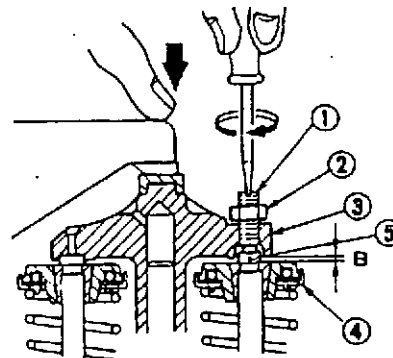

300517

**NOTE** If clearance (B) between bridge (3) and valve rotator (4) is less than 0.5 mm (0.020 in.), valve cotter would come off. Be sure to keep this clearance greater than 1.5 mm (0.059 in.).

Valve clearance adjustment

1. Loosen lock nut (7) for adjusting screw (6) (on push rod side of rocker).
2. Turn adjusting screw (6) in either direction to reduce or increase valve clearance between rocker arm and bridge with a feeler gauge inserted between the two.

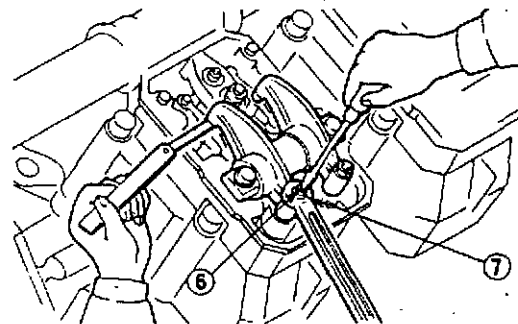

301607

EVERY 1000 HOURS OR 3 YEARS – continued

How to use the turning gear

1. Loosen bolts (1) and (2), and take plate (3) off groove of shaft (4). Then, push in shaft (4) all the way.
2. Put socket (5) and ratchet handle (6) to hexagonal end of shaft (4) and turn the shaft for cranking engine. Engine will crank in normal direction if ratchet handle is pushed down.
3. After cranking engine, pull out shaft (4), restore plate (3) to its original position, and tighten bolts (1) and (2), making sure that plate (3) is properly fitted in groove of shaft (4).

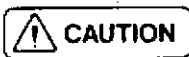

When starting the engine, make sure that turning gear is in RUN position.

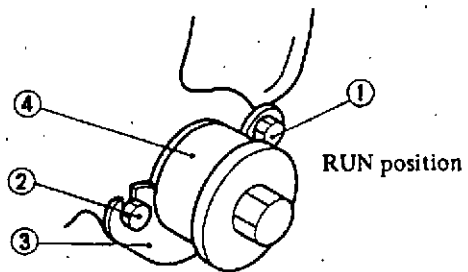

301608

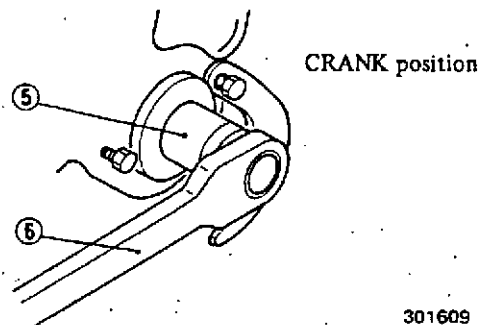

301609

EVERY 2000 HOURS OR 5 YEARS

Heat exchanger – Wash.

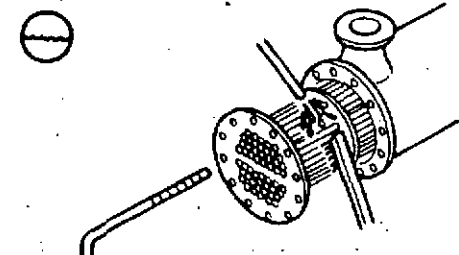

300125

Wash outside surfaces of pipes with a brush by dashing fresh water over them. Remove scale from inside of pipes by inserting a bar.

**NOTE** Use a soft brush for cleaning.

Alternator – Check.

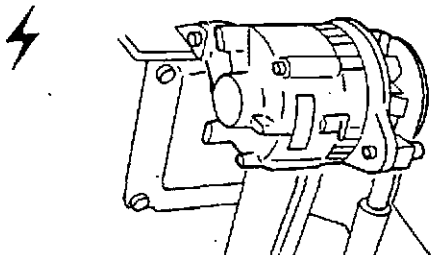

301611

Visually check for any defect. Remove V-belt from alternator pulley and turn alternator by hand to test for abnormal noise by ear.

Air cooler – Clean.

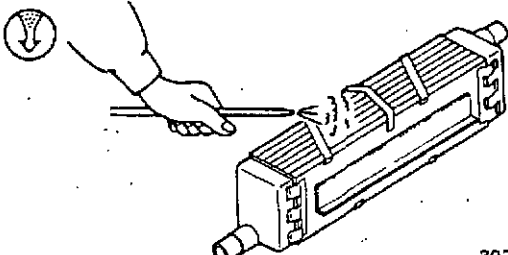

302037

Remove air cooler, and direct pressure air in direction opposite to air flow. Remove scale from inside of fresh-water or sea-water pipes by inserting a bar.

Starters – Check.

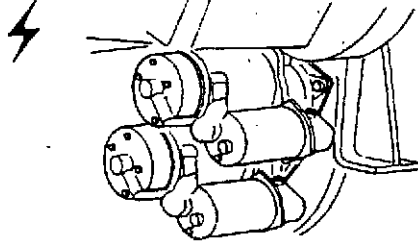

301614

Visually check for any defects. Check pinion for proper shifting and meshing.

Turbochargers – Check.

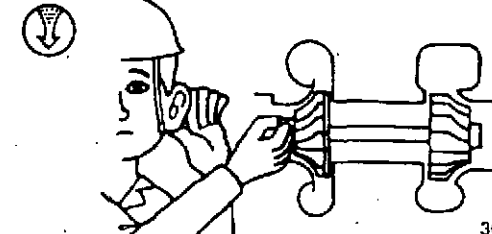

300124

Turn compressor wheel by hand to check for rattling by feel and for abnormal noise by ear. If wheel is noisy or rattles, replace bearings.

Vibration damper – Check.

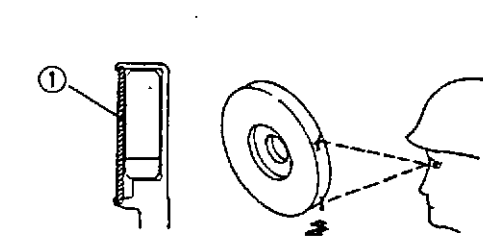

301612

Check for fluid leaks, flaws, distortion, cracks in rubber, discoloration of painted surfaces and flaking. Check cover (1) for swelling (by feel), fluid leakage from staked portion and discoloration of painted surface.

# STORAGE

## Preparation for prolonged storage (3 months or more)

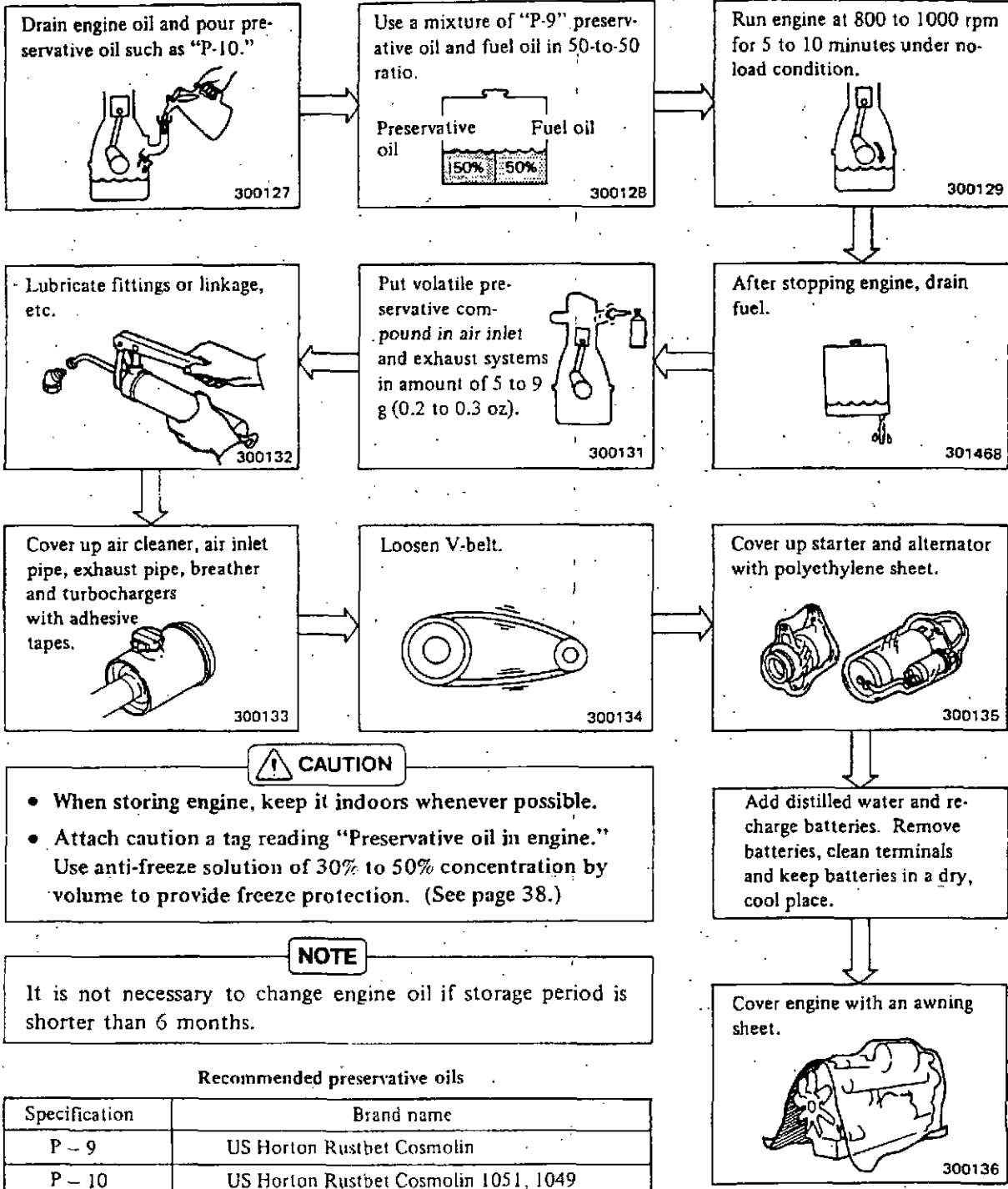

**CAUTION**

- When storing engine, keep it indoors whenever possible.
- Attach caution a tag reading "Preservative oil in engine." Use anti-freeze solution of 30% to 50% concentration by volume to provide freeze protection. (See page 38.)

**NOTE**

It is not necessary to change engine oil if storage period is shorter than 6 months.

Recommended preservative oils

Specification	Brand name
P - 9	US Horton Rustbet Cosmolin
P - 10	US Horton Rustbet Cosmolin 1051, 1049

### Service during storage

Recharge batteries at least once a month.

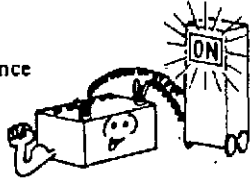

300137

### Preparing a stored engine for service

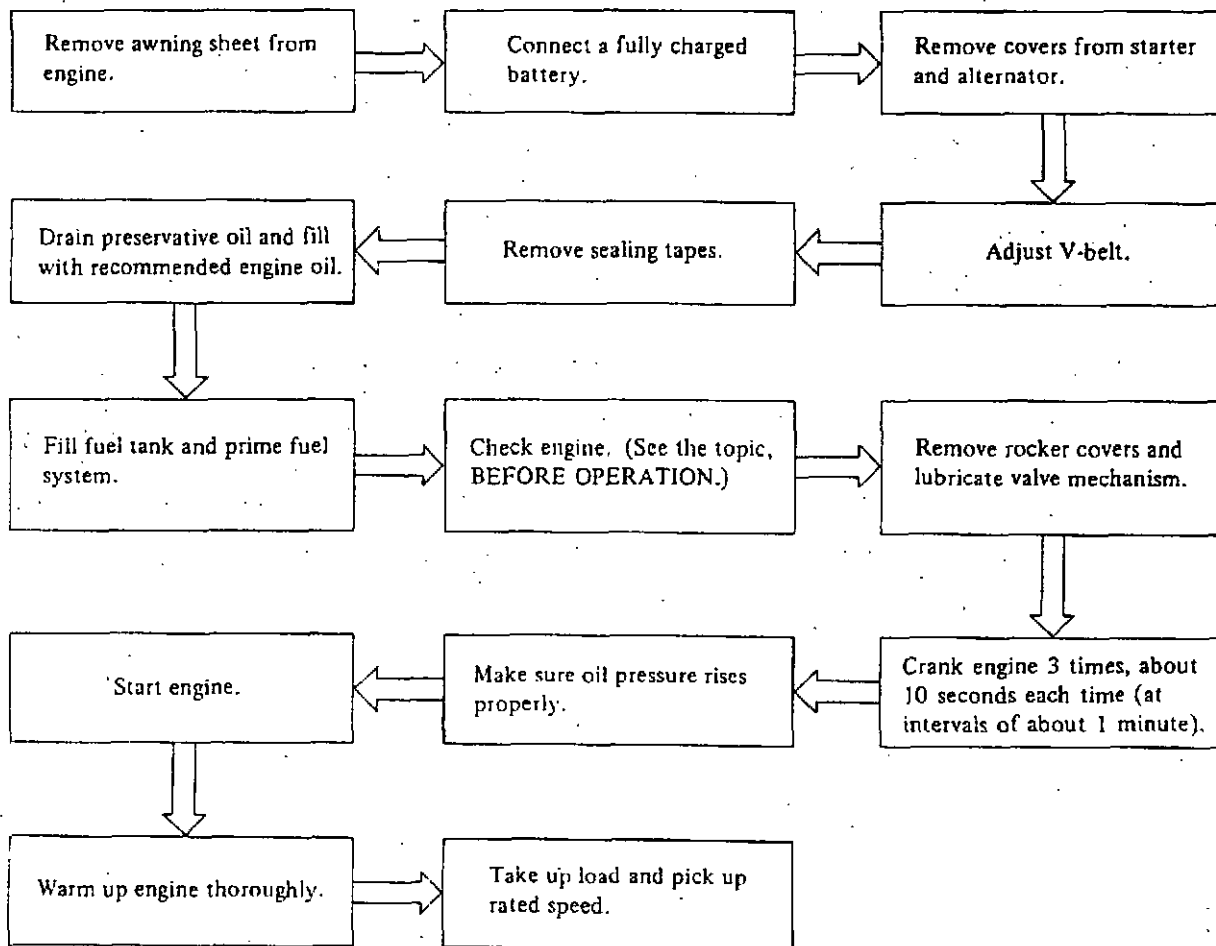

## FUELS, COOLANT AND LUBRICANTS

### FUELS FOR MITSUBISHI ENGINES

Mitsubishi diesel engines are designed to use diesel fuel oil meeting the requirements of JIS (Japanese Industrial Standard) K2204. JIS K2204 diesel fuel oil nearly corresponds to Class 2-D fuel oil specified by ASTM (American Society for Testing and Materials) D975. For pour point, refer to the following chart:

Ambient temp. °C (°F)	-30 (-22)	-20 (-4)	-10 (14)	0 (32)	10 (50)	20 (68)	30 (86)	40 (104)
Gas oil (JIS K2204)	No. 3, special	No. 3	No. 2	No. 1	No. 1, special			

#### NOTE

The fuel should be fluid enough to flow from the fuel tank to the injection pump. The pour point of the fuel should be at least 18°C (10°F) below the lowest atmospheric temperature at which the engine should start and operate. This will generally provides a fuel that will flow readily from the fuel tank to the injection pump.

#### Fuel cleanliness

1. Use a storage tank, and allow fuel to stand at least 24 hours in this tank before pumping it to the diesel fuel tank. Be sure to drain all water and sediment that has settled to the bottom of the storage tank before the diesel fuel tank is refilled.
  
2. Fill the diesel fuel tank at the end of the day. This will drive out moisture-laden air and prevent condensation.

#### CAUTION

Filters for burner fuels (furnace oils or domestic heating fuels) differ from those for diesel fuels. Never use burner fuel in an engine equipped with a filter for diesel fuel.

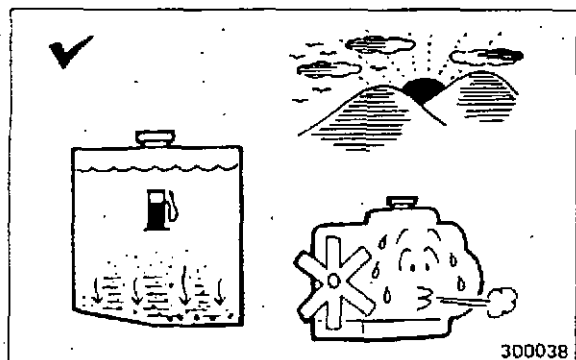
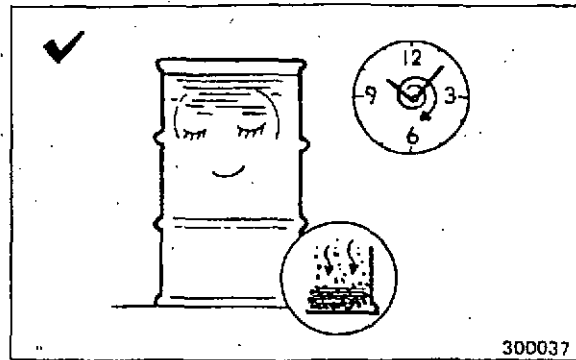

3. When refilling the diesel fuel tank, use clean tools, such as a hand pump, funnels, containers, hoses, etc. Wipe filler cap clean before removing it. When operating the hand pump, keep in mind that there could be water and sediment that has settled to the bottom of storage tank; tap the needed amount of fuel from clean top portion.

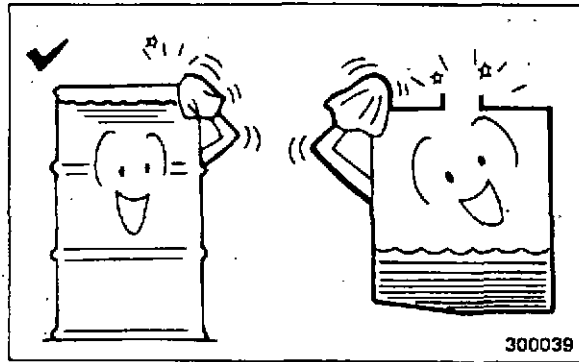

4. Be sure to pour fuel through strainer in the filler opening. Use of a lint-free cheese cloth is a good practice for keeping dirt out.

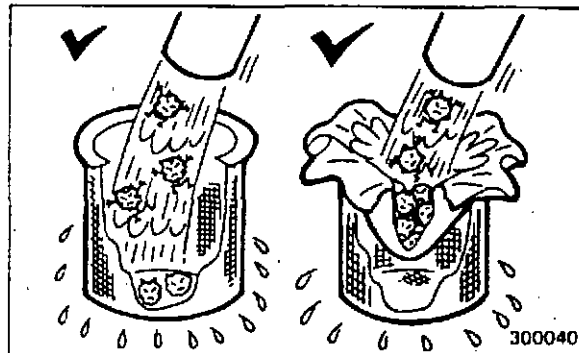

5. Occasionally, open the drain cock of the storage and diesel fuel tank to drain off any water or sediment that may have accumulated.

**NOTE**

Even clean top portion of fuel oil contains more or less dirt and water. Such dirt and water should be removed before they get inside the engine. This method of cleaning fuel oil is called "draining."

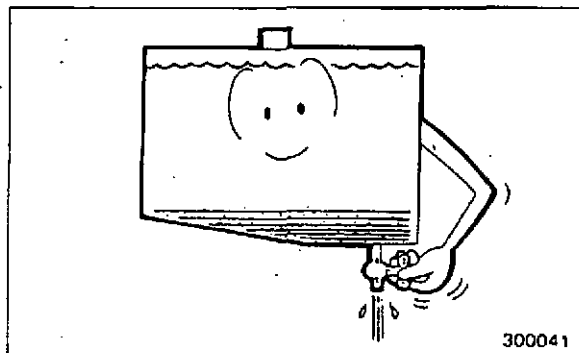

**COOLANT**

1. Water used in the cooling system must be soft, or as free from scale forming minerals as possible. Water, such as is available from the city water supply, is generally soft enough for the engine.
2. River water and well water are most likely to contain large amount of scale forming minerals and should not be used. Remember, some waters, particularly those pumped from ground in a mining or hot-spring area, contain active impurities harmful to cylinder liners of your engine.
3. Be sure to service the zinc rods installed in the sea-water circuits at regular intervals.
4. Use permanent-type anti-freeze solution through the year within a concentration range of 30% to 50%.

Temperature, C (°F)	Above -11 (12)	Above -15 (5)	Above -19 (-2)	Above -25 (-13)	Above -31 (-24)
Recommended antifreeze concentration, % by volume	30	35	40	45	50
Amount of water, % by volume	70	65	60	55	50

**Care in hot weather**

Give particular attention to overheating of the engine by observing the water temperature gauge and oil pressure gauge. When the engine is overheated, remove the load rather slowly, and allow the engine to idle for gradual cooling.

**⚠ WARNING**

Do not attempt to pour cold water into an overheated radiator; you will have scalding hot coolant or steam spouted out from the radiator.

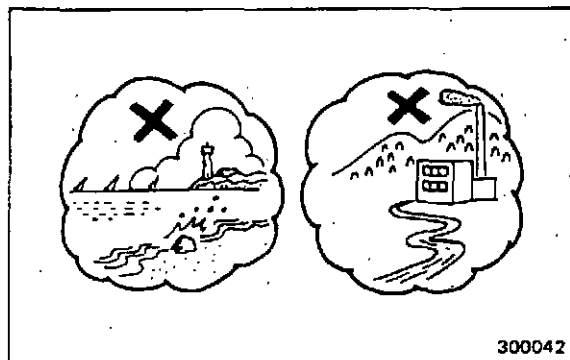

300042

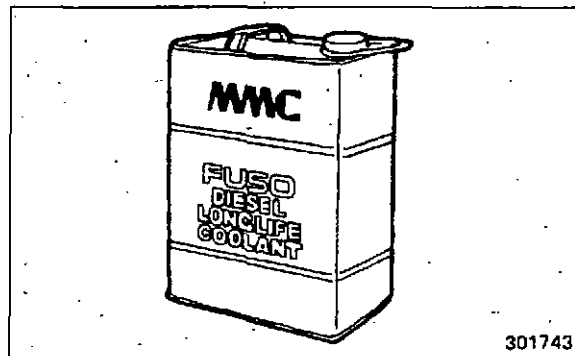

301743

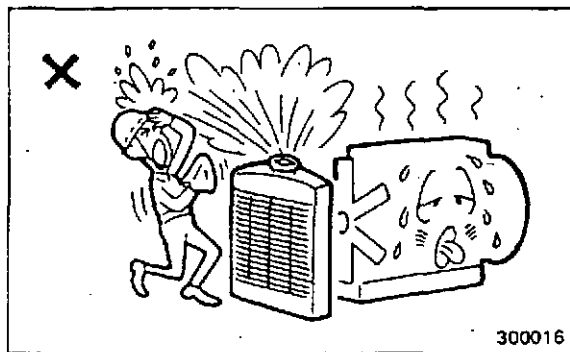

300016

**LUBRICANTS**

**Engine oil**

Careful attention to the following information on engine oil and its proper selection will add much to performance, economy and long life of your engine – a high-speed, high-load diesel engine.

1. Be sure to use engine oil of the API (American Petroleum Institute) service classification "CD."
2. Avoid mixing engine oils of different brands. In some cases, different brands are not compatible with each other and, when mixed, can seize parts such as piston rings, cylinder liners, etc. or abnormally wear moving parts. It is best to stick with one and the same brand of engine oil at successive service intervals.

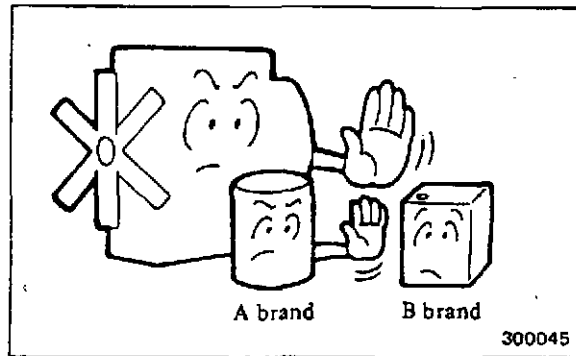
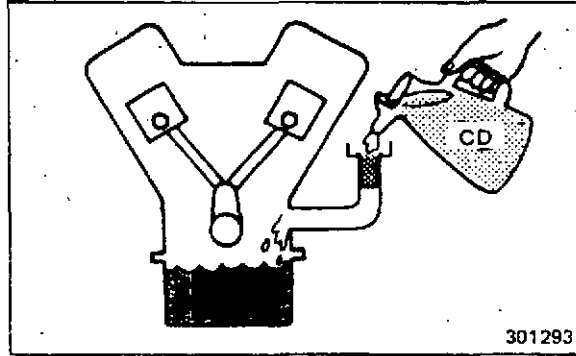

**3. Draining and refilling**

To change the oil, drain it out while the engine is still hot after a duty operation: the oil is hot and will rush out, washing out the sludge. After draining, allow the engine to idle for about 5 minutes with a flushing oil in the oil pan and refill with fresh oil upon draining the flushing oil.

**CAUTION**

It is prohibited by the law to cast aside waste engine oil indiscriminately. Have your Mitsubishi dealer dispose of such an oil.

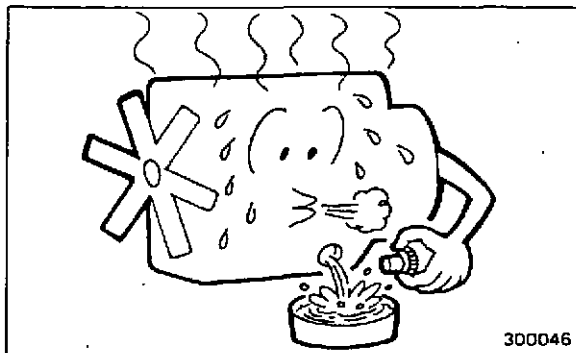

**Grease**

Use clean multi-purpose grease for your engine.

**CAUTION**

Cleanliness is important for handling engine oil and grease. Use clean handling tools; wipe filler cap, grease fittings and plugs clean; and handle them in a dust-free condition.

## FUELS, COOLANT AND LUBRICANTS

### Selection

Refer to the following charts in selecting engine oil and grease:

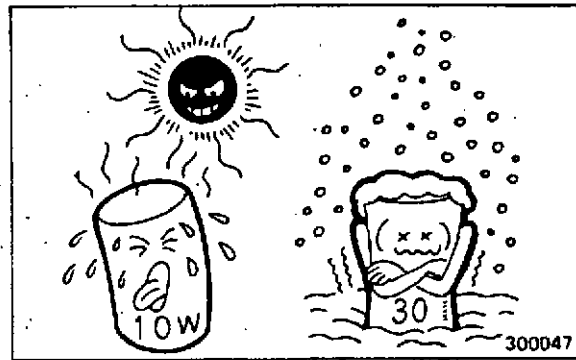

Starting temperatures and grades of lubricants

Ambient temp. C (°F)	-30 (-22)	-25 (-13)	-20 (-4)	-15 (5)	-10 (14)	-5 (23)	0 (32)	10 (50)	20 (68)	30 (86)	40 (104)
Engine oil											
Grease	NLGI No. 0, 1						NLGI No. 2				

### Recommended engine oils

Manufacturer	Brand name
Mitsubishi	Diamond HDS-3 Engine oil
Esso	Essolube D-3
General	General Gemico Super S-3
Idemitsu	Apollo Oil Diesel Motive Custom
Kygnus	Mighty Oil S-3
Kyodo	Kyoseki Delmate D
Cosmo	Cosmo Multi Diesel, Cosmo Diesel CD
Mobil	Mobil Delvac 1300 series
Nippon	High Diesel S-3
Showa-Shell	Shell Rimula Z Oil White Parrot Super S-3

When using oils other than these recommended ones, they should be of API service classification "CD" and meet the requirements of MIL-L-2104C.

## TROUBLESHOOTING

### General instructions

#### 1. Think before acting

Upon noting an abnormal symptom, recall what you did the last time when you ran across the same symptom. If what you did was correct and successful, do the same. If the symptom noted is new to you, think of possible causes in accordance with the troubleshooting procedure which follows.

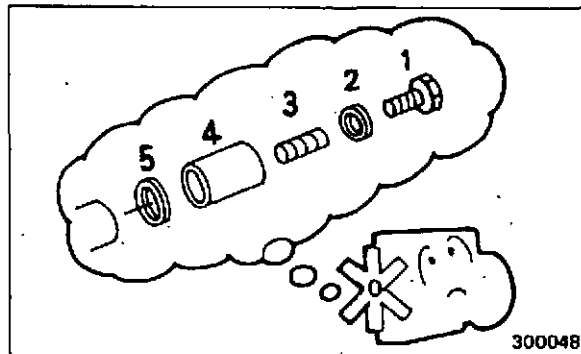

#### 2. Dust and dirt are often the ultimate causes.

"Wear" is usually a result of abrasive particles. When disconnecting or disassembling a part or component, be sure to keep off dust and dirt.

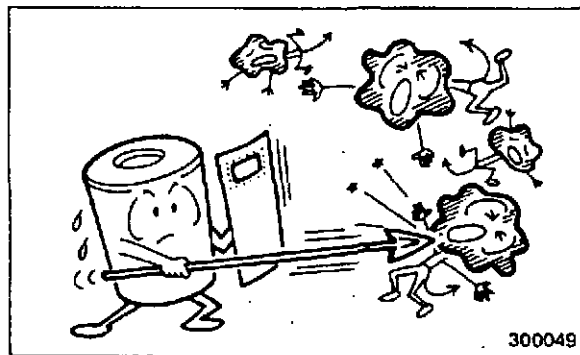

#### 3. Use genuine Mitsubishi parts.

Use only genuine parts to replace those that have failed or reached the service limit. When ordering, specify the needed replacement parts by referring to the Mitsubishi Parts Catalogues.

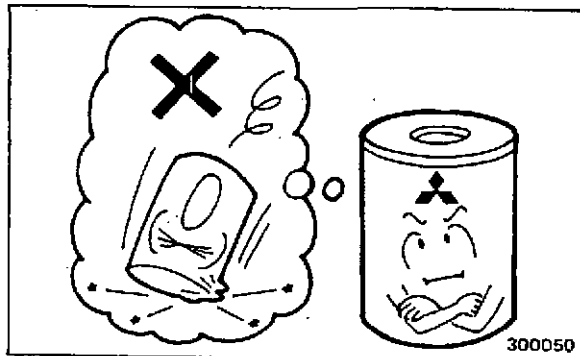

#### 4. Perform servicing work safely.

Use the right kind of hand tool to carry on each working step in repair work. Avoid injury to yourself and damage to the parts by using improper tool. When lifting or carrying a part too heavy for one person to handle, get another person's help and, if necessary, use a jack or a hoist to avoid personal injury.

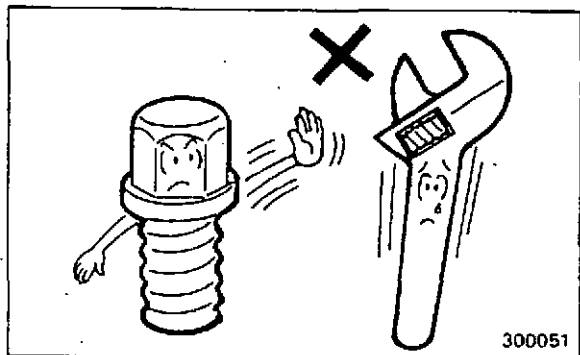

## TROUBLESHOOTING



### CAUTION

- Never attempt to break the seals of the governor for maximum speed setting and maximum injection quantity setting.
- The maximum injection quantity of injection pumps has been set on the basis of the output horsepower of each engine verified in the bench test. Never attempt to vary this injection quantity in field.

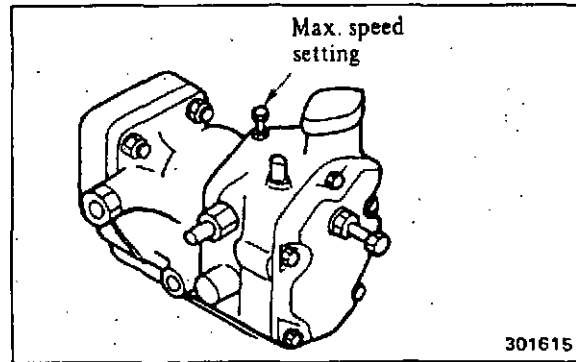

Electric-starting engine



300053



300054

Starter will not crank engine or cranks slowly, resulting in a failure of engine to start

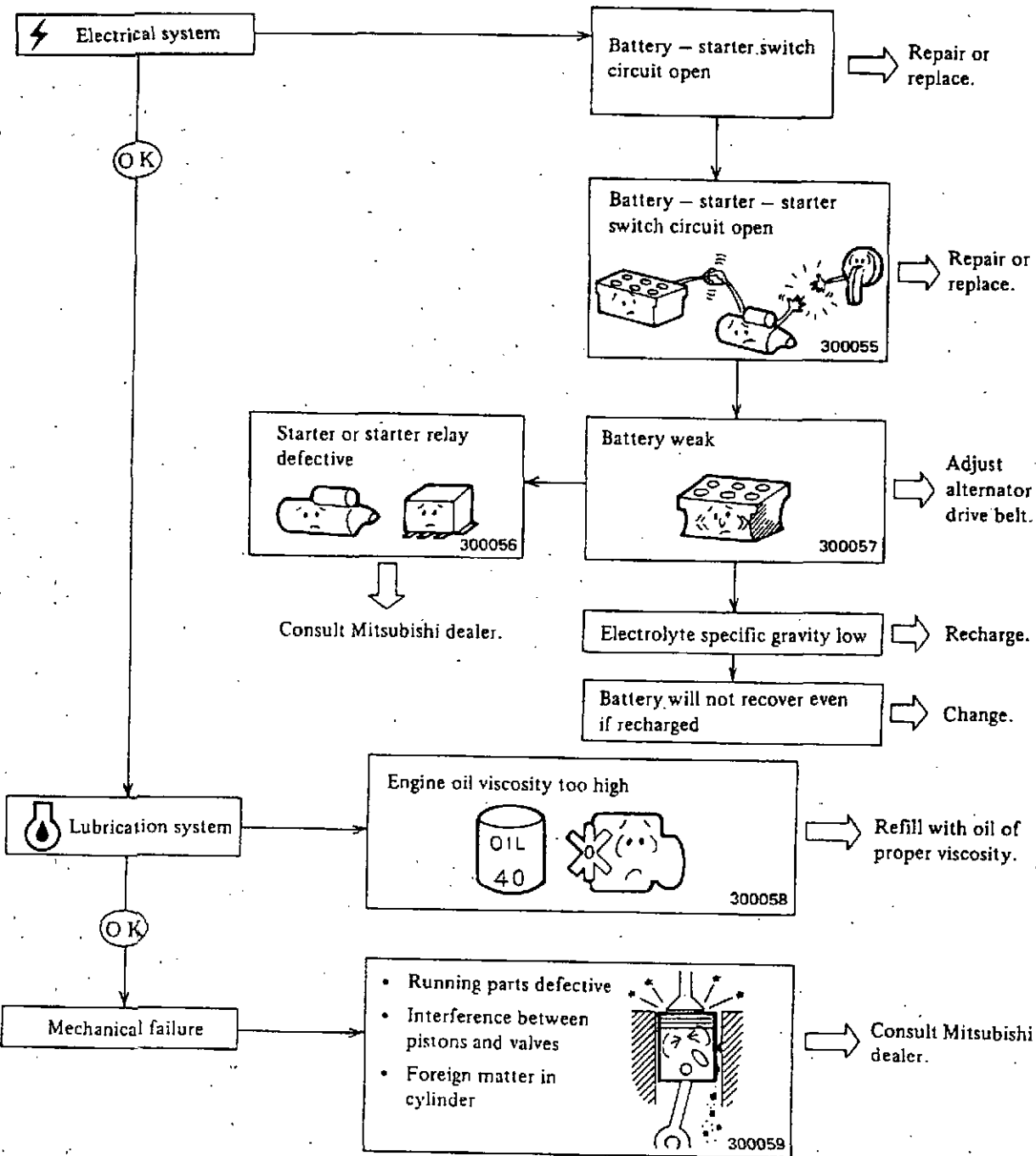

Starter will crank engine, but engine will not start



300060

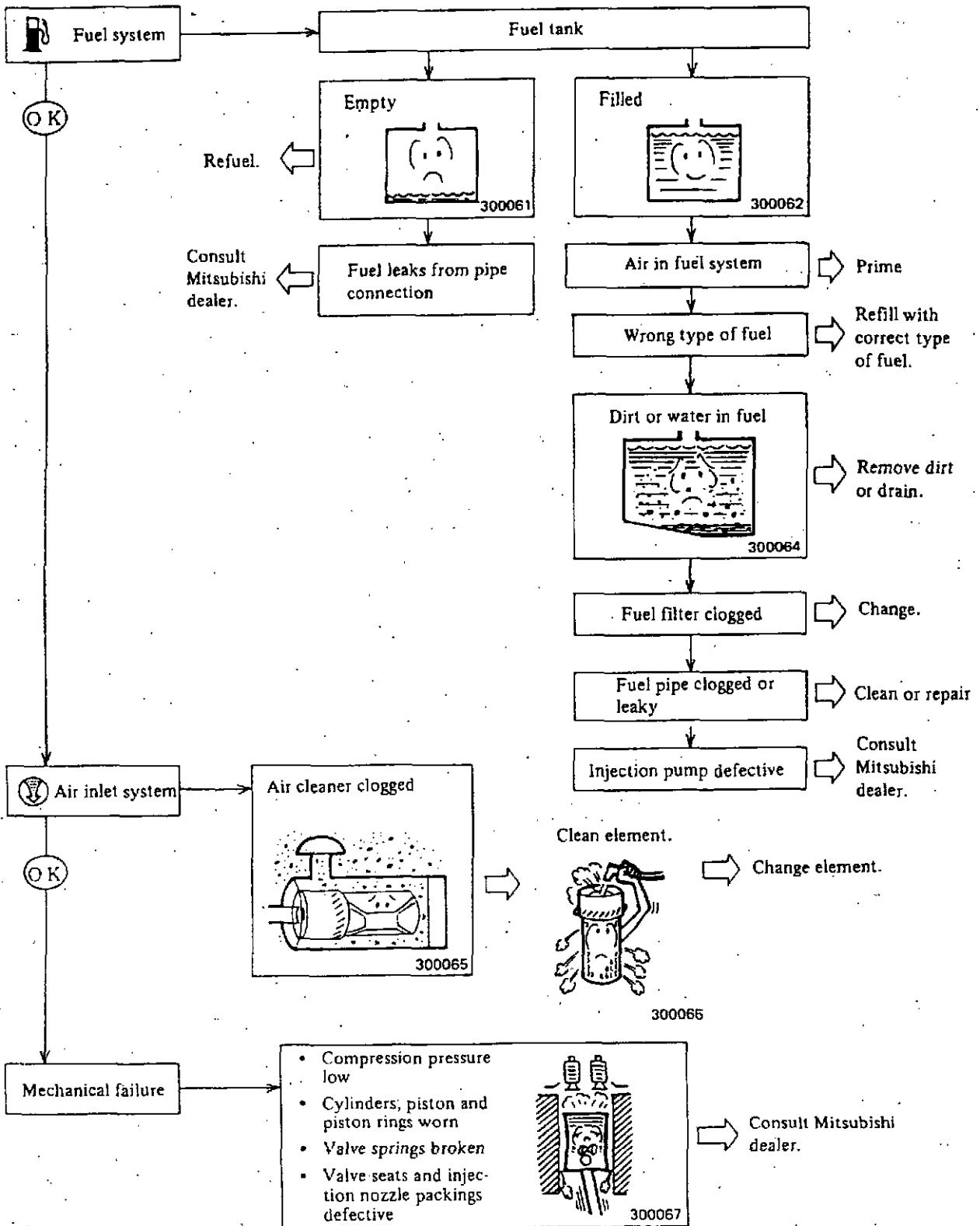

**Air-motor engine**

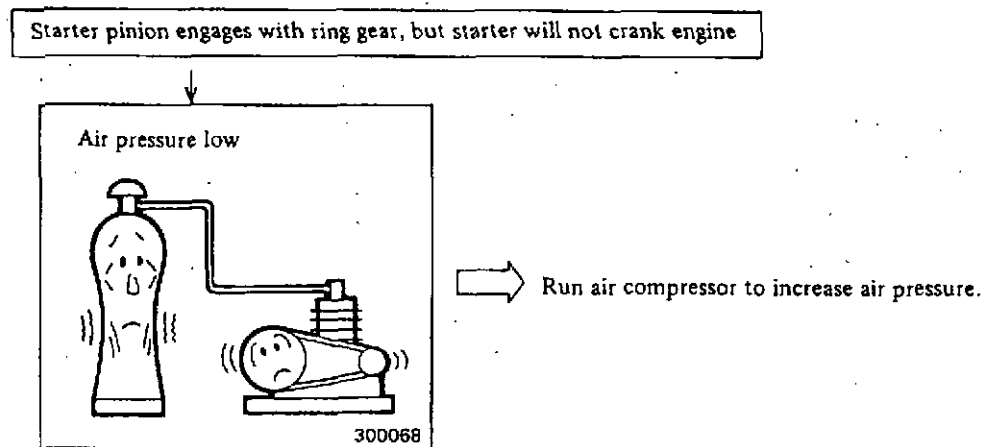
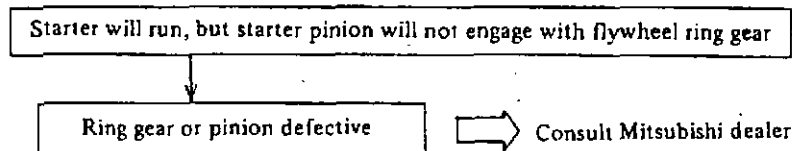
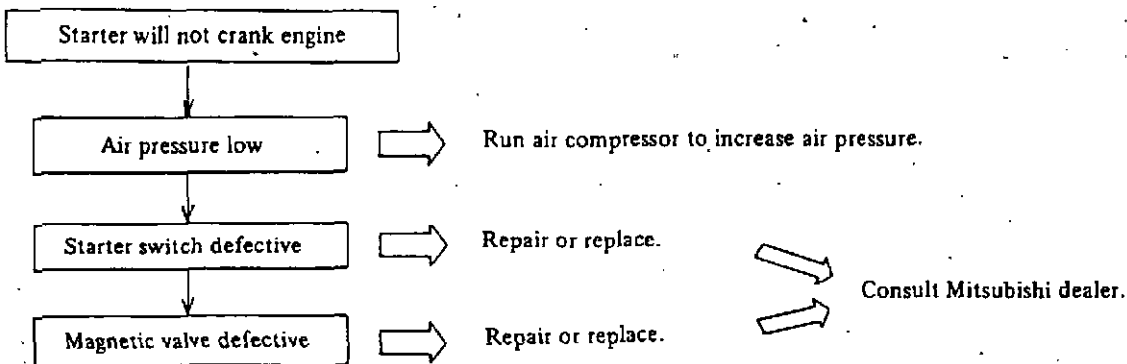



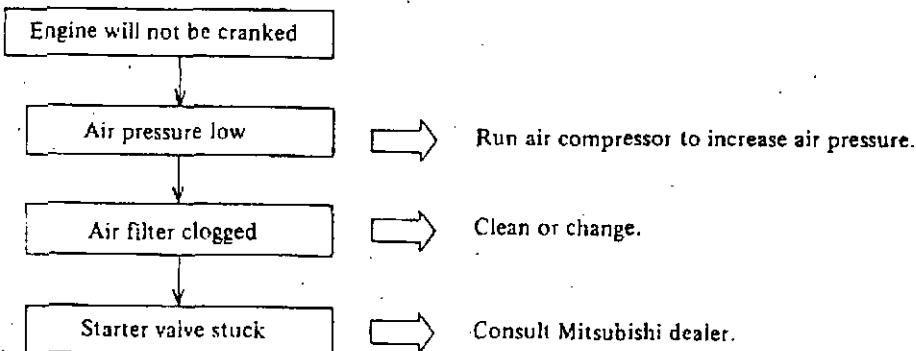



**Air-start engine**



TROUBLESHOOTING

Others

Complaint	Possible causes	Remedy
<p>Engine lacks power</p>  <p>500040</p>	<ul style="list-style-type: none"> <li>• Incorrect grade of oil</li> <li>• Wrong type of fuel</li> <li>• Insufficient air (air cleaner clogged)</li> <li>• Engine overcooled</li> <li>• Fuel feed pump gauze filter clogged</li> <li>• Engine overheating</li> <li>• Valve clearance incorrect</li> <li>• Injection pump defective</li> <li>• Injection nozzles defective</li> <li>• Injection timing incorrect</li> <li>• Compression pressure low (cylinders and pistons worn)</li> </ul>	<ul style="list-style-type: none"> <li>• Use recommended type and SAE number of oil.</li> <li>• Change.</li> <li>• Clean or change element.</li> <li>• Use radiator cover or replace parts.</li> <li>* Clean gauze filter.</li> <li>• Flush cooling system or replace parts.</li> <li>• Readjust.</li> <li>* Readjust or replace.</li> <li>* Readjust or replace.</li> <li>* Readjust.</li> <li>* Disassemble and replace parts.</li> </ul>
<p>White or blue exhaust smoke</p>  <p>500041</p>	<ul style="list-style-type: none"> <li>• Too much oil in crankcase</li> <li>• Oil viscosity too low</li> <li>• Engine overcooled</li> <li>• Thermostat defective (no water temperature rise)</li> <li>• Injection timing incorrect</li> <li>• Compression pressure low</li> <li>• Wrong type of fuel (low cetane number)</li> </ul>	<ul style="list-style-type: none"> <li>• Fill only to correct level on gauge.</li> <li>• Refill with correct viscosity of oil.</li> <li>• Use radiator cover or replace parts.</li> <li>* Replace.</li> <li>* Readjust.</li> <li>* Disassemble and replace parts.</li> <li>• Change.</li> </ul>
<p>Black or gray exhaust smoke</p>  <p>500042</p>	<ul style="list-style-type: none"> <li>• Wrong type of fuel</li> <li>• Valve clearance incorrect</li> <li>• Injection pump defective</li> <li>• Compression pressure low</li> <li>• Insufficient air (air cleaner clogged)</li> </ul>	<ul style="list-style-type: none"> <li>• Refill with correct type of fuel.</li> <li>• Readjust.</li> <li>* Readjust or replace.</li> <li>* Disassemble and replace parts.</li> <li>• Clean or change element.</li> </ul>
<p>High fuel consumption</p>  <p>500043</p>	<ul style="list-style-type: none"> <li>• Injection pump defective</li> <li>• Injection nozzles defective</li> <li>• Injection timing incorrect</li> <li>• Wrong type of fuel</li> <li>• Compression pressure low</li> <li>• Insufficient air</li> </ul>	<ul style="list-style-type: none"> <li>* Readjust or replace.</li> <li>* Readjust or replace.</li> <li>* Readjust.</li> <li>• Refill with correct type of fuel.</li> <li>* Disassemble and replace parts.</li> <li>• Clean or change air cleaner element. Check turbocharger.</li> </ul>

Complaint	Possible causes	Remedy
High oil consumption  500044	<ul style="list-style-type: none"> <li>• Too high oil level in crankcase</li> <li>• Incorrect grade of oil</li> <li>• Oil leaks</li> <li>• Cylinders and piston rings worn</li> </ul>	<ul style="list-style-type: none"> <li>• Maintain oil level in correct range on gauge.</li> <li>• Use recommended type and SAE number of oil.</li> <li>• Retighten or replace.</li> <li>* Disassemble and replace parts.</li> </ul>
Engine overheats  500047	<ul style="list-style-type: none"> <li>• Radiator or heat exchanger dirty</li> <li>• Friction rubber deteriorated</li> <li>• Lack of coolant</li> <li>• Water pump defective</li> <li>• Thermostat defective</li> </ul>	<ul style="list-style-type: none"> <li>• Wash.</li> <li>* Replace.</li> <li>• Refill.</li> <li>* Replace.</li> <li>* Replace.</li> </ul>
Low oil pressure  500045	<ul style="list-style-type: none"> <li>• Lack of oil</li> <li>• Oil viscosity too low</li> <li>• Oil filters clogged</li> <li>• Oil pump defective</li> <li>• Oil pressure regulating valve defective</li> <li>• Oil pressure sensor circuit defective</li> </ul>	<ul style="list-style-type: none"> <li>• Refill up to level.</li> <li>• Refill with correct viscosity of oil.</li> <li>• Replace element.</li> <li>* Readjust, clean or replace.</li> <li>* Readjust or replace.</li> <li>* Replace.</li> </ul>

- Remarks:
1. Consult your Mitsubishi dealer for items marked with asterisk (\*).
  2. Consult your Mitsubishi dealer for any item other than those listed above.
  3. When communicating with your Mitsubishi dealer, give model designation, serial number and service meter reading of your engine.

## SPECIFICATIONS

Model designation		S16R	
		T	TA
Type		Water-cooled, 4-stroke cycle, turbocharged	
		Aftercooled	Intercooled
Number of cylinders		16	
Bore x stroke		170 x 180 mm (6.693 x 7.087 in.)	
Piston displacement		65.3 liters (3985 cu in.)	
Fuel injection system		Direct	
Compression ratio		14.0 : 1	
Firing order		1-9-6-14-2-10-4-12-8-16-3-11-7-15-5-13	
Rotation		Counterclockwise as seen from flywheel side	
Dimensions	Length	2875 mm (113.2 in.)	
	Width	1360 mm (53.5 in.)	
	Height	1810 mm (71.3 in.)	
Dry weight		6100 kg (13451 lb)	6200 kg (13671 lb)
Fuel system	Fuel	No. 2-D specified by ASTM D975 or Class A specified by B.S 2869	
	Injection pumps	Mitsubishi PS8 type x 2	
	Governor	Woodward PSG hydraulic or electronic type	
	Fuel filters	Paper-element (spin-on type)	
	Injection nozzles	Hole type	
	Injection pressure	350 <sup>+5</sup> / <sub>0</sub> kgf/cm <sup>2</sup> (4977 <sup>+71</sup> / <sub>0</sub> psi) [34.3 <sup>+0.5</sup> / <sub>0</sub> MPa]	
Lubrication system	Type	Pressure feed (by oil pump)	
	Oil	API CD class	
	Capacity	200 liters (52.8 U.S. gal) approx. (oil pan)	
	Oil filter	Paper-element type (with bypass filter, spin-on type)	
	Oil cooler	Water-cooled multi-disc type (built in crankcase)	
Cooling system	Type	Forced circulation by centrifugal pump	
	Capacity (engine)	170 liters (45 U.S. gal) approx.	
	Fresh-water pump	Centrifugal type	
Starting system		Electric or air (air motor or direct air)	
Starter		24V - 7.5 kW x 2	
Alternator		24V - 30 A	
Turbochargers		Mitsubishi TD13 or TD10 type x 4	

## TIGHTENING TORQUE

### Major bolts and nuts



Parts attached	Thread Diam.—Pitch mm	Width across flats mm	Tightening torque			Remarks
			kgf·m	lbf·ft	N·m	
Cylinder heads	M22 x 2.5	27	55	398	539	[Wet]
Rocker cases	M12 x 1.25	17	11	80	108	
Rocker shafts	M14 x 2	19	15	108	147	
Camshaft gear	M12 x 1.25	18	11	80	108	
Camshaft thrust plate	M12 x 1.25	17	6	43	59	
Main bearing caps	M24 x 3	30	60	434	588	[Wet]
Main bearing cap side bolts	M20 x 2.5	27	40	289	392	[Wet]
Hangers	M20 x 1.5	30	40	289	392	
	M16 x 1.5	24	22	159	216	
Piston cooling nozzles	M12 x 1.75	17	3.5	25	34	
Timing gear case	M16 x 1.5	24	22	159	216	
Rear plate	M12 x 1.25	17	6	43	59	
	M16 x 1.5	24	22	159	216	
Oil pan	M12 x 1.25	17	6	43	59	
Mounting brackets	M20 x 1.5	30	40	289	392	
Connecting rod bearing caps	M22 x 1.5	27	55	398	539	[Wet]
Balance weights	M22 x 1.5	32	50	362	490	[Wet]
Flywheel	M22 x 1.5	32	60	434	588	[Wet]
Ring gear	M10 x 1.25	14	6	43	59	
Vibration damper	M22 x 1.5	32	50	362	490	
Timing idler gear	M12 x 1.25	17	11	80	108	
Idler shaft collar	M16 x 1.5	24	22	159	216	
Front gear case	M12 x 1.25	17	6	43	59	
	M16 x 1.5	24	22	159	216	
Front plate	M12 x 1.25	17	6	43	59	
Idler shaft	M12 x 1.25	17	11	80	108	
Idler gear thrust plate	M10 x 1.25	14	3	22	29	
Oil pump and water pump mounting plate	M12 x 1.25	17	6	43	59	
Bearing cover	M12 x 1.25	17	11	80	108	
Injection pump drive cases	M12 x 1.25	17	11	80	108	
Injection pump gears (nuts)	M30 x 1.5	46	40	289	392	
Injection pump coupling shafts	M14 x 1.5	22	17 to 18	123 to 130	167 to 177	Tighten slit portion.
Oil pump	M12 x 1.25	17	11	80	108	
Oil pump cover	M10 x 1.25	14	3.4	25	33	

TIGHTENING TORQUE

Parts attached	Thread Diam.—Pitch mm	Width across flats mm	Tightening torque			Remarks
			kgf-m	lbf-ft	N-m	
Water pump	M12 x 1.25	17	11	80	108	For alterna- tor drive
Water pump shaft pulley (nut)	M30 x 1.5	46	40	189	392	
Fan drive case	M12 x 1.25	17	11	80	108	
Fan drive gear (nut)	M30 x 1.5	46	40	189	392	
Fan drive coupling (nut)	M30 x 1.5	46	40	189	392	
Fan drive hub	M12 x 1.25	17	11	80	108	
Fan drive shaft	M12 x 1.25	17	6	43	59	
Injection pump brackets	M12 x 1.25	17	11	80	108	
Injection pumps	M12 x 1.25	17	11	80	108	
Injection pump laminated plates	M12 x 1.25	17	8.5 to 9.5	61 to 69	83 to 93	
Injection pump flywheels (nuts)	M24 x 1.5	36	28 to 30	203 to 217	275 to 294	
Plunger assemblies	M12 x 1.25	19	8 to 8.5	58 to 61	78 to 83	
Delivery valve holders	M30 x 1.5	32	24 to 26	174 to 188	235 to 255	
Injection nozzle glands (nuts)	M14 x 1.5	22	10	72	98	
Injection nozzle tips (nuts)	M28 x 1.5	27	18 to 20	130 to 145	177 to 196	
Injection nozzle adjusting screw nuts	M14 x 1.5	22	4 to 5	29 to 36	39 to 49	
Injection nozzle inlet connectors	M16 x 1.5	19	6.5 to 7.5	47 to 54	64 to 74	
Governor drive case	M12 x 1.25	17	11	80	108	
Starters	M12 x 1.25	17	6	43	59	

Remarks: Apply a coat of engine oil to the threads of parts indicated as [Wet].

## Standard bolts and nuts

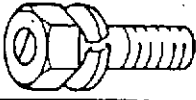
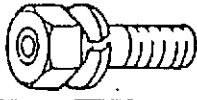
	M-thread Dia x Pitch	Width across flats, mm	Strength classification					
			7T			10.9		
			kgf·m	lbf·ft	N·m	kgf·m	lbf·ft	N·m
Metric automotive thread								
	M8 x 1.25	12	1.7	12	17	3.1	22	30
	M10 x 1.25	14	3.4	25	33	6.1	44	60
	M12 x 1.25	17	6.1	44	60	11.0	80	108
	M14 x 1.5	22	9.9	72	97	17.9	129	176
	M16 x 1.5	24	14.8	107	145	26.7	193	262
	M18 x 1.5	27	21.4	155	210	38.5	278	378
	M20 x 1.5	30	29.7	215	291	53.4	386	524
	M22 x 1.5	32	39.3	284	385	70.8	512	694
			49.7	359	487	89.5	647	878
Metric coarse thread								
	M10 x 1.5	14	3.3	24	32	5.9	43	58
	M12 x 1.75	17	5.8	42	57	10.4	75	102
	M14 x 2	22	9.5	69	93	17.0	123	167
	M16 x 2	24	14.2	103	139	25.6	185	251
	M18 x 2.5	27	19.8	143	194	35.7	258	350
	M20 x 2.5	30	27.7	200	272	49.9	361	489
	M22 x 2.5	32	37.0	268	363	66.6	482	653
	M24 x 3	36	47.7	345	468	86.0	622	843

- Remarks: (a) Use these torques for bolts and nuts with spring washers.  
 (b) The tolerance of these torques is  $\pm 10\%$ .  
 (c) Do not coat threads with oil.

# SCHEMATIC

## FUEL SYSTEM

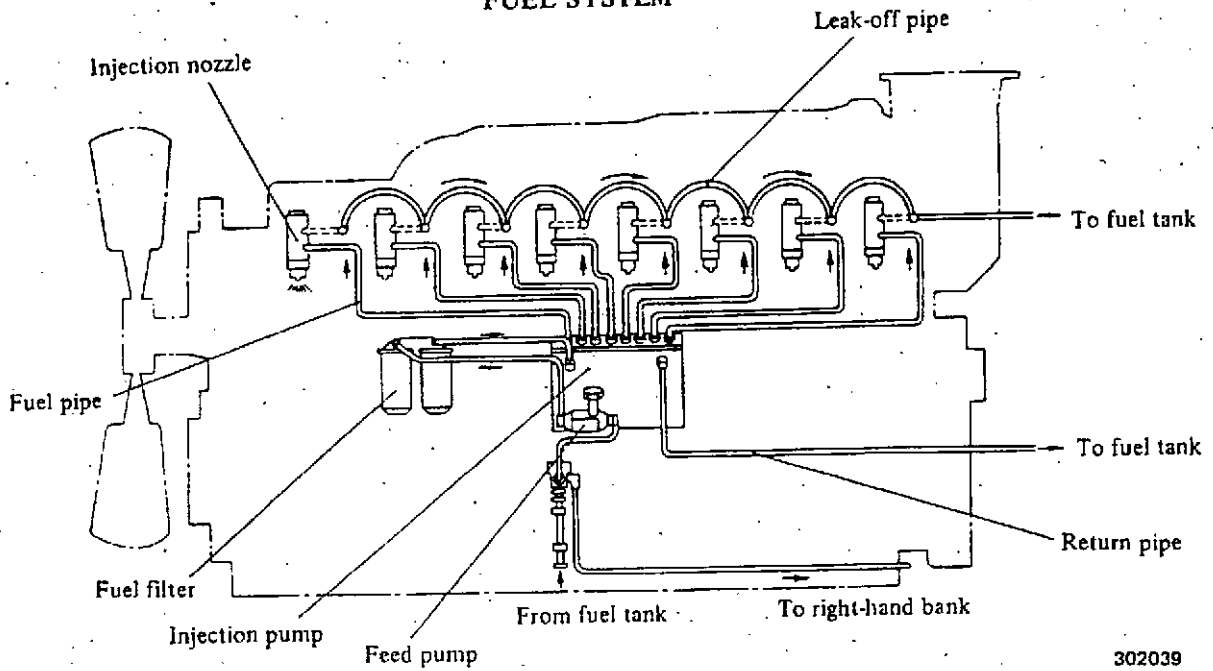

302039

## LUBRICATION SYSTEM

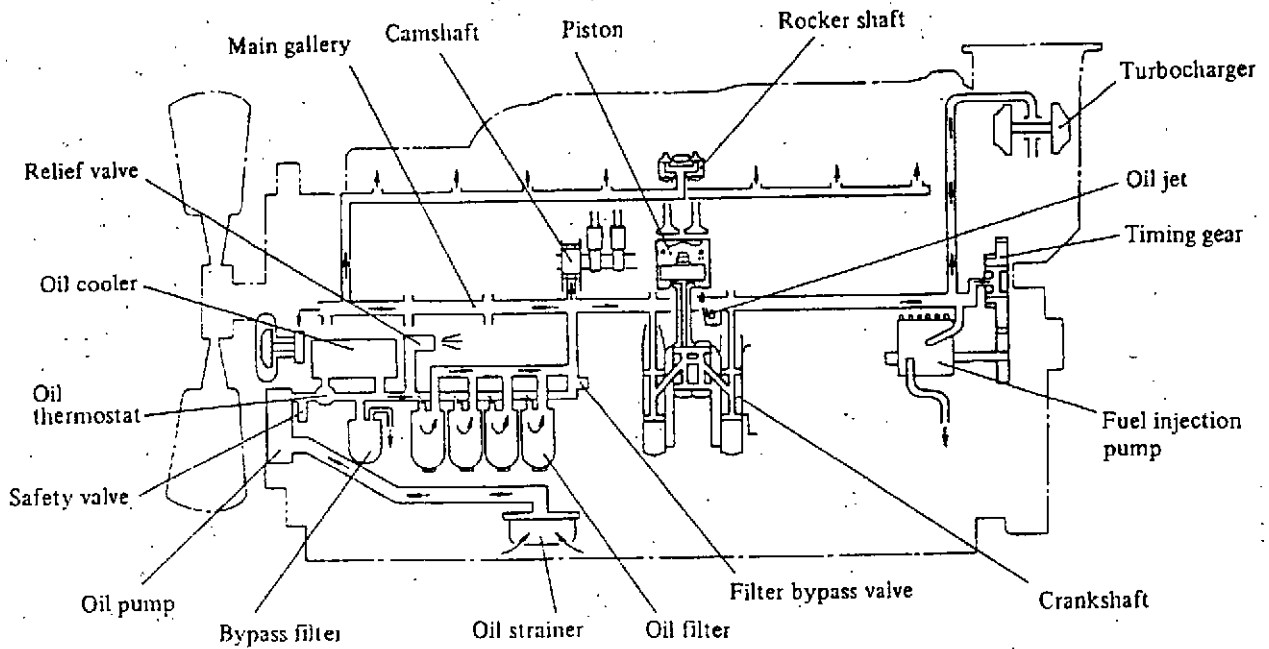

302040

COOLING SYSTEM

Radiator-cooled engine (PTA)

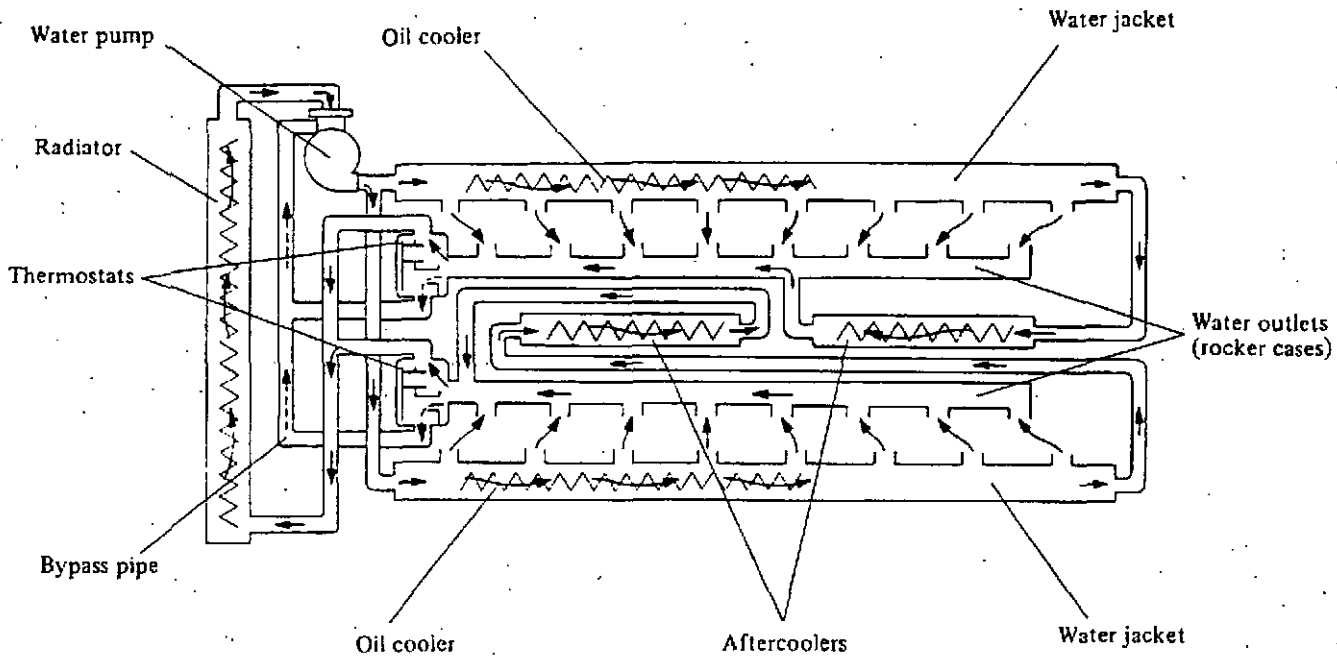

302041

Dual cooling system (parallel piping) (PTK)

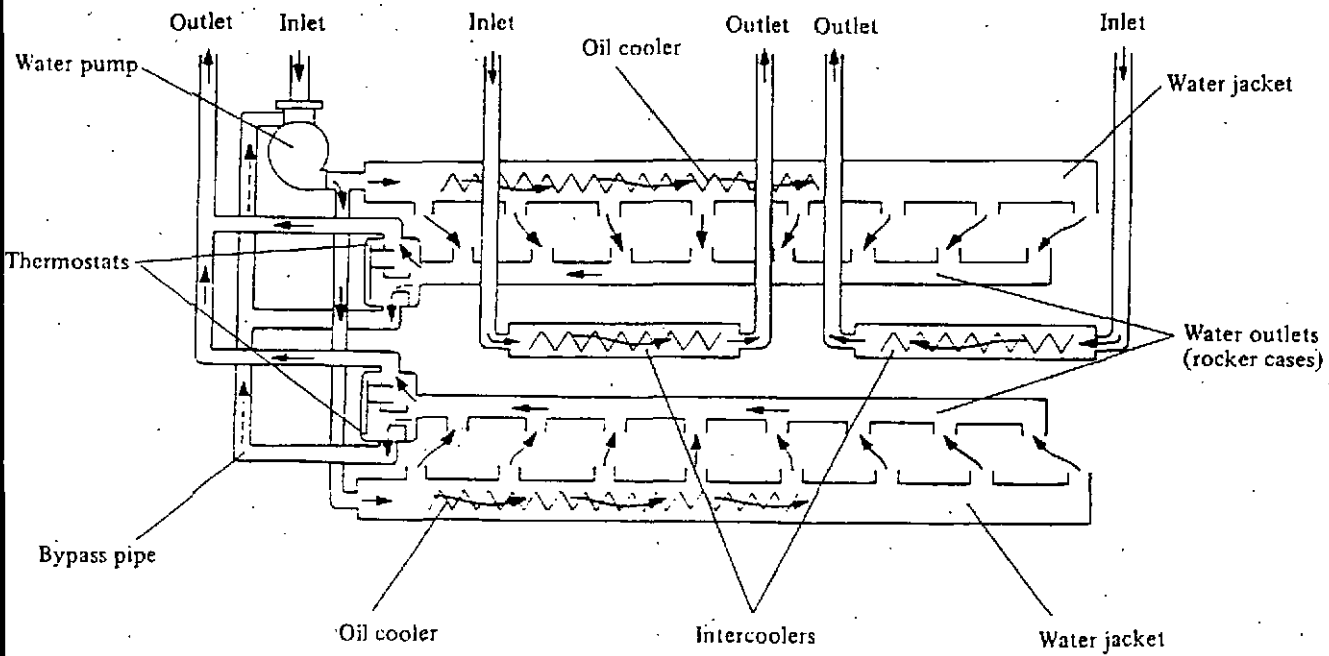

302042

ELECTRICAL SYSTEM

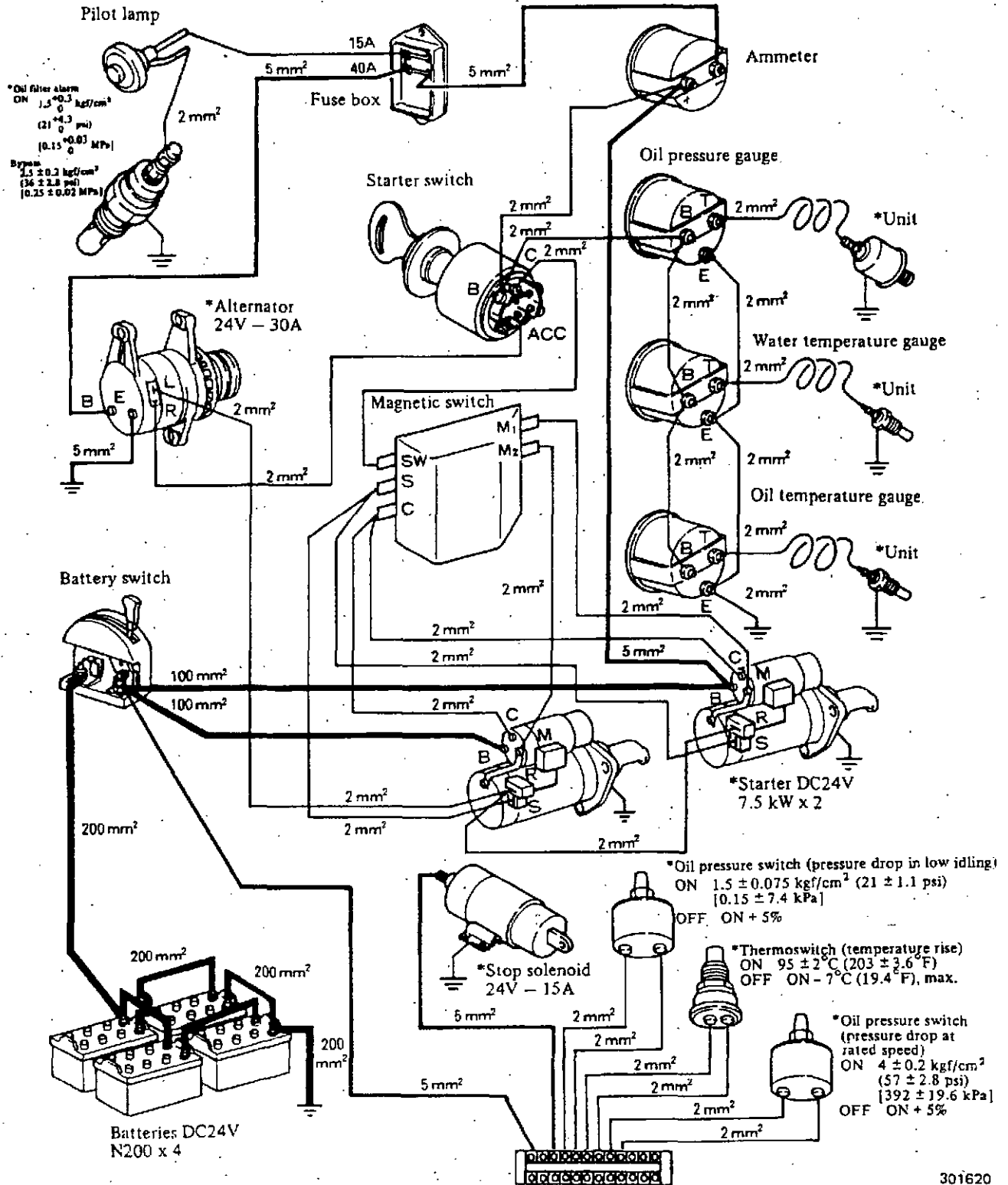

301620

- Remarks:
1. The circuit shown above is standard and varies from one specification or application to another.
  2. The circuit and its components are to be prepared in field.
  3. Asterisk (\*) indicates the parts mounted on the engine. Parts having no asterisk are to be prepared as a single item.

AIR START SYSTEM

Air-motor engine

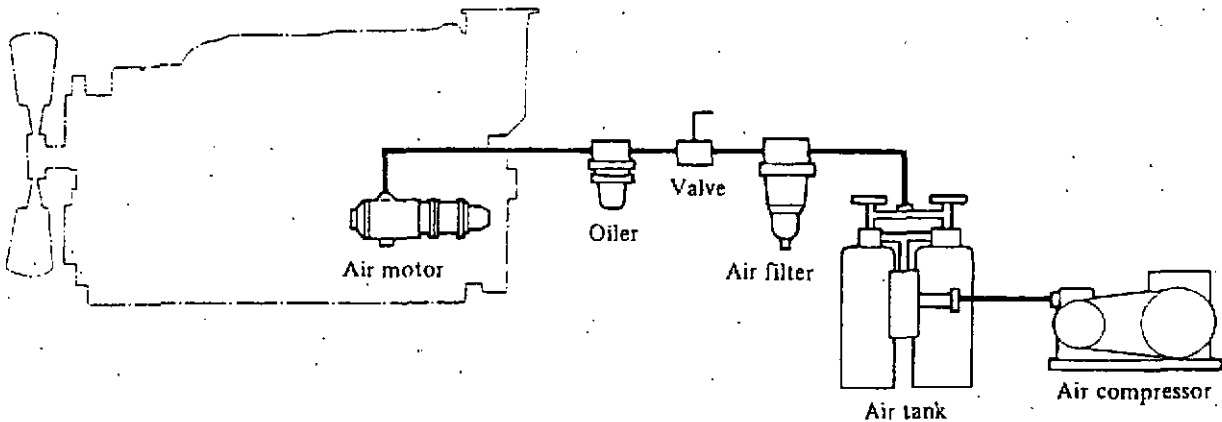

302043

Air-start engine

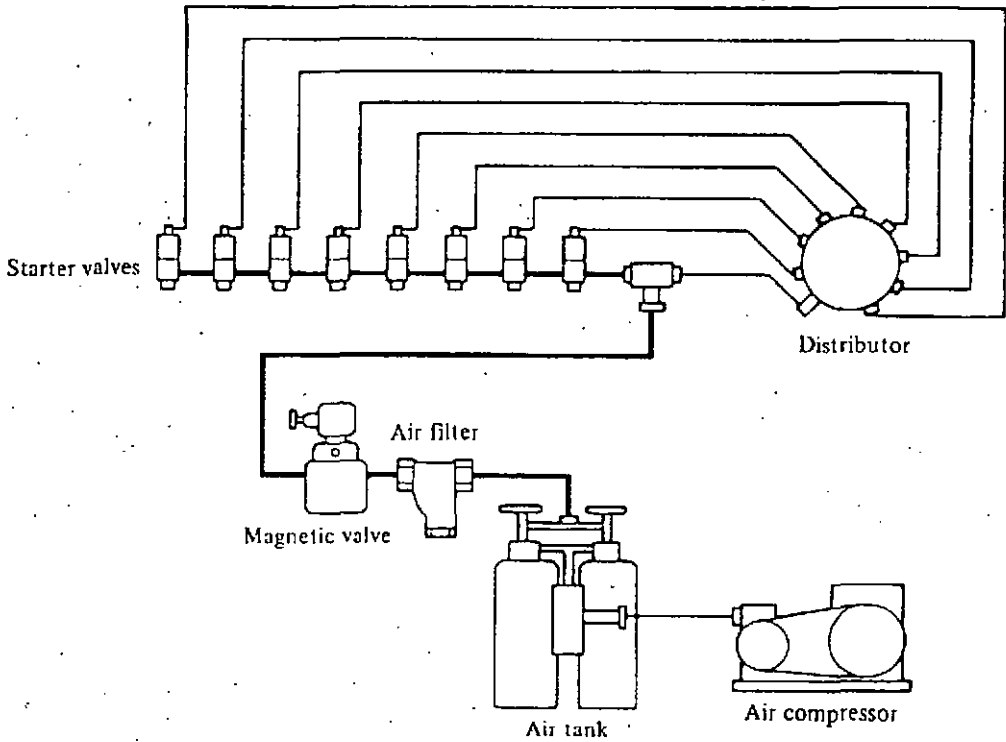

301622

