

**G 1400
AND
G 1600
OPERATIONS
AND
MAINTENANCE
MANUAL**

**FOUR CYLINDER
OVERHEAD VALVE GASOLINE ENGINES**

WHITE

ENGINES, INC.

CANTON, OHIO 44707

Introduction

This Manual is intended for guidance of the personnel, who operate, maintain, or repair White engines or components. It furnishes necessary information for operation, as well as for adjustments, lubrications, periodic checks, and maintenance of the engine.

The Manual applies basically to the engine. Information concerning accessories are given only when it relates to the engine and may not assist in the repair of the accessory itself. An accessory needing repair should be taken to the Authorized Service Depot.

All locations given as right hand (r.h.) or left hand (l.h.) are determined by the observer while facing the flywheel end of the engine. Number "one" cylinder is the one closest to the gear cover end. All dimensions are given in inches or fractions of inches except as otherwise noted, while all weights and measures are in U.S. Avoirdupois or liquid measure standards.

Proper service practices save expensive down time and costly repairs. When repairs or replacements are needed always insist on genuine White precision parts in ordering to insure maximum satisfaction and long lasting service. Your dealer can supply these genuine parts and assist you with any additional information that is required.

When ordering replacement parts always give the engine Model and Serial Number. These are stamped on the Identification Plate located on the lower left-hand side of the cylinder block.

The Manual is divided into the following Major Sections:

- FITS & TOLERANCES
- OPERATION
- SERVICE & MAINTENANCE
- TROUBLE SHOOTING
- SPECIFICATIONS

As an operator, you owe it to yourself to read this Manual carefully and completely.

NOTE: ENGINE OPERATION BELOW 1200 RPM REQUIRES FACTORY AUTHORIZATION.

WHITE

ENGINES, INC.

CANTON, OHIO 44707

LIMITED WARRANTY

INDUSTRIAL ENGINE

White Engines, Inc. warrants each new engine or component thereof, sold by it to the original owner-user as follows:

For eighteen (18) months from date of shipment from the factory, or for twelve (12) months of service, or for 1,000 hours of service, whichever shall first occur, (or for such other period of time as may be agreed upon in writing by White Engines, Inc. in respect to the application in which the engine is used) that said engine and component shall be free from defects in material and workmanship.

For any engine or component which is, or becomes defective within the period set forth above, White Engines, Inc. shall furnish to the original owner-user, without charge, parts to replace those parts which upon inspection are determined by White Engines, Inc. to have been defective in material or workmanship.

This warranty does not obligate White Engines, Inc. for the cost of labor or transportation charges in connection with the replacement of defective parts or repair of the engine.

The foregoing warranty does not apply to normal maintenance services or adjustment or to an engine upon which repairs or alterations have been made unless the repairs or alterations were authorized in writing by White Engines, Inc.

White Engines, Inc. makes no warranty in respect to trade accessories. Trade accessories are subject to the warranties of their respective manufacturers.

Other than as set forth above, SELLER MAKES NO WARRANTY OF ANY KIND WHATSOEVER, EXPRESS OR IMPLIED; AND ANY IMPLIED WARRANTY OF MERCHANTABILITY OR FITNESS FOR A PARTICULAR PURPOSE, OTHER THAN AS CONTAINED HEREIN AND HEREBY LIMITED AS TO DURATION IS HEREBY DISCLAIMED.

THIS WARRANTY SUPERSEDES ANY PREVIOUS WARRANTIES AND TAKES EFFECT JULY 1, 1978.

INDEX

Air System	16
Basic Engine and Parts	28
Battery Charging System	26
Bellhousing	32
Camshaft and Timing Gear	36
Cold Weather Starting	10
Cooling System	17
Crankshaft	33-34
Cylinder Head, Valves and Rocker Arms	28 to 30
Description and Maintenance	16 to 39
Electrical System	26 to 28
Fans	19
First Time Engine Started	9-10
Fits and Tolerances	5-6
Flywheel	31-32
Fuel System	22
Fuel Pump	22-23
General Description and Features of Design	8
Gear Cover	38
Governor	23 to 25
Inspection	29
Introduction	1
Lubricating Oil Specifications	13
Lubricating Oil System	20
Lubricating Instructions	12-13
Main Bearings	34
Manifold	17
Operation	9
Oil Filter	14
Oil Pan	20
Piston and Connecting Rods	38
Piston Rings	39
Precautions	9
Preventive Maintenance Schedule	13-14
Specifications	4
Starting the Engine	10
Stopping the Engine	10
Storing the Engine for Long Periods	11-12
Timing the Engine	27-28
Torque Requirements	7
Trouble Shooting	15
Viscosity Grades (Luboil)	13
Valves	29-30
Warranty	2
Water Pump and Fan Assembly	18-19
Wiring Diagram	27

GENERAL SPECIFICATIONS

	G1600	G1400
Bore and Stroke	4" x 3 $\frac{1}{4}$ "	3 $\frac{7}{8}$ " x 3"
No. of Cylinders	4	4
Horsepower-Stripped Engine (2800 RPM-corrected)	67	
Piston Displacement Cu. In.	163	141
Firing Order	1-3-4-2	1-3-4-2
Crankshaft Rotation (When viewed from front)	Clockwise	
Camshaft Rotation (When viewed from front)	Counter-clockwise	
Idler Rotation (When viewed from front)	Counter-clockwise	
Accessory Drive Rotation (When viewed from front)	Clockwise	

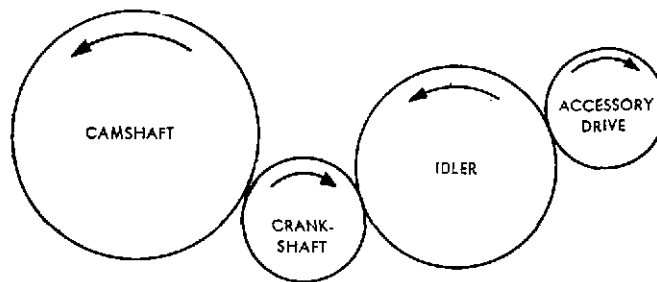

CYLINDER BLOCK

Material Gray Cast Iron

LUBRICATION

Forced Feed By Gear Pump

Oil Capacity — Oil Pan 6 Qts.) plus
Oil Filter 1 Qt.)

CYLINDER HEAD

Detachable One Piece Alloy
Cast Iron

Valve Arrangement Overhead

Exhaust Valve Hi Alloy Forging
Two Piece Welded Sil-Chrome Steel

Intake Valve Hi Alloy Forging
Forty Stem Sil-Chrome Steel

PISTON

Material Heat Treated Aluminum Alloy

PISTON PIN

Full-Floating Type Alloy Steel

CRANKSHAFT

Material Heat Treated Steel Forging
Number of Bearings Three

CAMSHAFT

Driven Helical Gear
Number of Bearings Three

CONNECTING ROD

Material Heat Treated Steel Forging

NOTE: See Fits & Tolerances For Specified Data.

WHITE ENGINES, INC. reserves the right to change design or specifications without notice.

FITS AND TOLERANCES

G-1400 - G-1600

Distributor Timing	(Prestolite IAD-6013 & IBT-4405)	6° BTDC. @ 800 RPM 18° BTDC. @ 1800 RPM
Distributor Point Gap020
Distributor Dwell	(Prestolite IAD-6013) (Prestolite IBT-4405)	39° - 45° 66° - 72°
Valve Lash, Hot and Cold	Intake & Exhaust	.015
Spark Plug Gap030
Engine Idle Speed		500 RPM
Distributor and Oil Pump to Camshaft Gear Backlash003 - .005
Crankshaft to Camshaft Gear Backlash0025 - .005
Crankshaft to Idler Gear Backlash003 - .012
Idler to Accessory Drive Gear Backlash003 - .005
Fan to Engine Speed Ratio		1.26:1
Water Pump to Engine Speed Ratio		1.00:1
Crank Gear to Crankshaft0005 T - .0015 T
Rocker Arm to Rocker Arm Shaft Clearance002 - .004
Camshaft End Clearance003 - .007
Crankshaft End Clearance	G1600 G1400	.004 - .009 .004 - .009
Top of Block to Top of Piston	G1600 G1400	.028 - .036 .0165 - .035
Connecting Rod Side Clearance	G1600 G1400	.004 - .010 .003 - .009
Camshaft Bearing Clearance001 - .0025
Crankshaft Main Bearing Clearance	G1600 G1400	.0009 - .0035 .0004 - .002
Valve Tappet Clearance in Block0005 - .0021
Valve Stem to Valve Guide Clearance	Intake Exhaust	.001 - .0025 .002 - .0035
Valve Seat Runout (Max.)002 T.I.R.
Valve Seat Width070 - .080
Valve Arrangement (Front to Rear)		E I I E E I I E
Cylinder Head Mounting Face Max. Out-of-Flatness	In any 6.00 inches Overall	.002 T.I.R. .004 T.I.R.

FITS AND TOLERANCES — (continued)

Cylinder Block Mounting Face Max. Out-of-Flatness		
	In any 6.00 inches	.002 T.I.R.
	Overall	.004 T.I.R.
Connecting Rod Bearing Clearance	G1600	.0013 - .0031
	G1400	.001 - .0028
Connecting Rod Bearing to Crankshaft Journal0012 - .0041
Combustion Chamber Volume		
With Valves and Spark Plug in Place		80.5 - 84.5 cc
(add 13.1 - 17.2 cc for piston clearance G1600)		
(add 11.1 - 16.8 cc for piston clearance G1400)		
G1600		
Piston Pin to Piston Clearance0000 - .0005
Piston Pin to Rod Clearance0002 - .0006
Piston to Cylinder Bore Clearance0012 - .0028
Piston Ring Groove Clearance		
Top Compression Ring to Groove Clearance002 - .0035
Lower Compression Ring to Groove Clearance002 - .004
Oil Control Ring to Groove Clearance		Snug
Ring Gaps		
Top Compression Ring Gap at 4.000 Gage Dia.010 - .020
Lower Compression Ring Gap at 4.000 Gage Dia.010 - .020
Oil Control Ring Rail Gap at 4.000 Gage Dia.015 - .055
Connecting Rod and Cap Bearing Lock Slots to be assembled on same side.		
Notch on top of Piston to be assembled towards front of engine.		
G1400		
Piston Pin to Piston Clearance0001 - .0005
Piston Pin to Rod Clearance0001 - .0005
Piston to Cylinder Bore Clearance001 - .003
Piston Ring Groove Clearance		
Top Compression Ring to Groove Clearance002 - .0035
Lower Compression Ring to Groove Clearance0015 - .0035
Oil Control Ring to Groove Clearance		Snug
Piston Ring Gaps		
Top Compression Ring Gap at	3.875	.013 - .023
Lower Compression Ring Gap at	3.875	.012 - .022
Oil Control Ring Gap at	3.875	.015 - .0055
Oil Pump Assembly		
Oil Pump Gears Backlash006 - .008
Oil Pump Gear End Clearance002 - .005
Oil Pump Shaft Clearance with Body001 - .002
Oil Pump Gears Clearance with Body001 - .005

TORQUE REQUIREMENTS

(ALL THREADS LUBRICATED WITH SAE 20 OIL)

APPLICATION	THD. SIZE	TORQUE
Main Bearing Cap Bolts	7/16 - 14	55- 60 ft. lbs.
Connecting Rod Nut	3/8 - 24	30- 35 ft. lbs.
Camshaft Gear to Camshaft	3/4 - 10	50- 55 ft. lbs.
Camshaft Thrust Plate	5/16 - 18	10- 15 ft. lbs.
Front Plate to Block	5/16 - 18	10- 15 ft. lbs.
Idler Shaft to Block	1/2 - 13	90-106 ft. lbs.
Gear Cover to Block	5/16 - 18	17- 21 ft. lbs.
Governor Attaching	3/8 - 16	20- 30 ft. lbs.
Accessory Drive Adapter Nut	1/2 - 20	35- 40 ft. lbs.
Hydraulic Pump to Adapter	3/8 - 16	20- 30 ft. lbs.
Flywheel to Crankshaft	7/16 - 20	75- 85 ft. lbs.
Flywheel Housing to Block		
Two Center Holes must be Permatexed	3/8 - 16	40- 45 ft. lbs.
Oil Pan Drain Plug	7/8 - 14	25- 35 ft. lbs.
Oil Pan to Block	5/16 - 18	9- 12 ft. lbs.
Oil Pan to Block	1/4 - 20	3- 4 ft. lbs.
Crankshaft Pulley to Crankshaft	9/16 - 18	135-145 ft. lbs.
Water Pump to Plate		
Apply Permatex to Screws	5/16 - 18	17- 21 ft. lbs.
Water Pump Pulley to Water Pump (low fan)	5/16 - 24	15- 18 ft. lbs.
Rocker arm shaft support to Cylinder Head	7/16 - 14	35- 40 ft. lbs.
Rocker Arm Shaft support to Cylinder Head Nut	7/16 - 14	35- 40 ft. lbs.
Rocker Arm Adjusting Screw	7/16 - 20	7- 15 ft. lbs.
Rocker Arm Cover to Rocker Arm support Nut	5/16 - 24	18- 24 in. lbs.
Cylinder Head	7/16 - 14	60- 65 ft. lbs.
Tappet Cover to Block	1/4 - 20	3- 4 ft. lbs.
Fuel Pump to Block	5/16 - 18	10- 15 ft. lbs.
Oil Filter Adapter to Block	3/8 - 16	23- 28 ft. lbs.
Oil Pump to Block	5/16 - 18	10- 15 ft. lbs.
Oil Strainer to Oil Pump	5/16 - 18	10- 15 ft. lbs.
Spark Plug	14 M/M	27- 30 ft. lbs.
Distributor Adapter to Block	3/8 - 16	25- 28 ft. lbs.
Distributor to Adapter	1/4 - 20	3- 4 ft. lbs.
Alternator to Bracket	5/16 - 18	10- 15 ft. lbs.
Intake Manifold to Head	3/8 - 24	30- 35 ft. lbs.
Exhaust Manifold to Head		
Apply Never Seeze Compound #NS-160	3/8 - 24	30- 35 ft. lbs.
Carburetor or Adapter Nut	3/8 - 24	30- 35 ft. lbs.
Water Outlet Housing	5/16 - 18	10- 15 ft. lbs.

GENERAL DESCRIPTION AND FEATURES OF DESIGN

The cylinder block and crankcase are cast in one piece and, in order to permit more efficient cooling, the cylinders are water jacketed the full length of the piston travel.

Three main bearings support the crankshaft. Main, connecting rod and camshaft bearings are the replaceable precision type. The upper shell in the crankcase is not interchangeable with the lower shell, except for the center main, which is the thrust bearing. Illustration No. 1 shows the sturdy construction.

A detachable cylinder head with balanced waterflow control and overhead valve arrangement is provided.

Aluminum alloy, three-ring pistons are used.

The lubricating system is the pressurized style, activated by a gear-type oil pump driven from the camshaft.

The oil pump forces the lubeoil under controlled pressure through the oil filter, through a passage in the cylinder block and camshaft bearing to the camshaft, which is hollow inside and acts as the main header for the lubeoil.

From the camshaft the oil is distributed, under pressure, through drilled passageways to all main, connecting rod and camshaft bearings, and also to the rocker arms and the governor. The cam lobes, valve tappets and cylinder walls are lubricated by means of oil drain-back and the mist of oil thrown off around the various pressure-lubricated bearings.

Effective liquid cooling within closely controlled temperature ranges is obtained by an efficient centrifugal water pump, together with thermostatic and pressure regulation of the system. Radiators of ample capacity and efficient fans are provided.

Twelve-volt electrical systems consisting of starter, belt-driven alternators and heavy-duty regulators are standard.

High efficiency, dry-type air cleaners of large capacity are standard equipment.

Provisions for other accessories, such as hydraulic or vacuum pumps, special governors, etc., are provided.

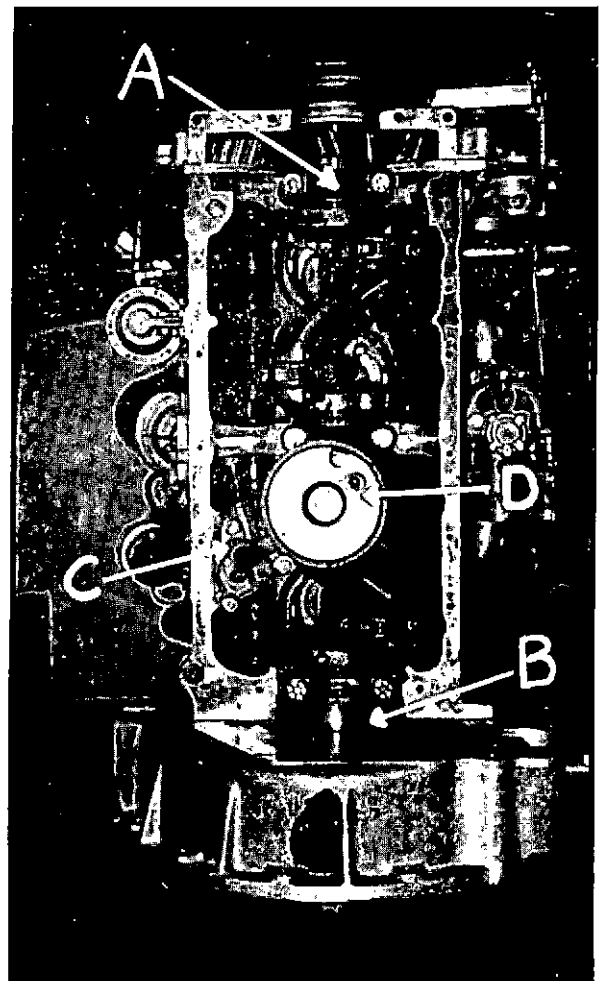

Illustration No. 1

OPERATION

NEW EQUIPMENT SERVICE AND INITIAL STARTING

To start the engine for the first time or after a long period of shutdown, proceed as follows:

1. Perform a visual inspection of the engine to make sure there are no loose bolts, nuts, and screws.
2. Check that no loose bars, tools, and parts are lying in or on any part of the engine when starting. They could cause serious damage to the engine or bodily injury to nearby personnel.
3. Remove all plugs, caps, covers, and tape from all openings of the engine, fuel tank, and electrical equipment. Do not overlook the exhaust pipe and intake openings.
4. Check the entire electrical system to be sure there are no loose connections and all component parts are securely mounted.
5. Check the lubrication of all accessories. Check the air cleaners to make sure they are not obstructed, and that they are clean and properly installed.
6. Fill the cooling system with clean water and rust inhibitor or, if the engine will be subjected to ambient air temperatures below freezing, use an antifreeze solution.
7. Remove any paper that was inserted between the pulleys and the belts to prevent belt sticking. Adjust fan belt tension by positioning the alternator so that the fan belts can be deflected approximately $\frac{3}{4}$ inch per foot of belt span when thumb pressure is applied at midpoint of the belt. Tighten alternator mounting screws.
8. Drain all preservative oil from the fuel system. Open the drain on the bottom of the bowl of the fuel strainer (if provided) and allow all water and sediment in the bowl to drain out. Close the fuel bowl drain, and check that the carburetor drain is closed. Check all fuel supply lines from the fuel tank to the fuel pump to make sure the connections are tight and the lines are open with no obstructions or kinks.
9. Fill the fuel tank with gasoline having an octane of 85 minimum as measured by the motor method. Leaded or unleaded fuel can be used.
10. Drain the crankcase, replace the oil filter element, and fill to the FULL mark on the oil level bayonet gauge, using lubricating oil recommended in Recommended Lubricating Oil Specifications. Add 1 quart of oil to compensate for the filter.
11. Tag and disconnect the spark plug wires and remove the spark plugs from the cylinder head. Squirt about a teaspoon of engine oil into each spark plug hole. Use the engine starter to turn the engine over until the oil pressure gauge on the instrument panel reads about 10 psi. This will ensure that the bearings and cylinder walls are adequately lubricated before a load is applied. If the engine is equipped with a mechanical fuel pump, this amount of cranking should also adequately prime the fuel system.
12. Reinstall the spark plugs and connect the spark plug cables.
13. If the engine is equipped with a manual choke, pull out the choke control lever to close the choke. Open the throttle about half way.
14. If the ambient air temperature is less than 32° F, refer to the cold weather starting instructions.
15. Do not crank the engine for more than 15 seconds at a time. Allow the starting motor to cool for 1 minute between periods of cranking.
16. Turn the ignition switch ON. Operate the ignition switch or start switch to crank the engine. It should start almost at once. If the engine does not start after two or three attempts, refer to Troubleshooting Section.
17. Once the engine has started, open the manual choke slightly until the engine runs smoothly. With an automatic choke, this function is performed by manifold vacuum. Continue to open the choke in small increments as the engine warms up. The choke should be fully open by the time the engine reaches normal operating temperature.
18. To ensure proper lubrication and extend engine life, allow the engine to run for several minutes before applying a load.

ROUTINE STARTING

If the engine has been operating recently and components have not been removed or repaired since it last operated, proceed as follows:

1. Check that there is an adequate fuel supply.
2. Check the lubricating oil level in the engine with the oil level bayonet gauge. Be sure the oil level is above the ADD mark on the gauge. See Illustration No. 2.
3. Check for proper level of coolant solution in the radiator.
4. Inspect the installation to see that all is secure and in good order, and that no loose tools, bars, or parts are lying on the engine.
5. If the ambient temperature is less than 32° F, refer to cold weather starting instructions.
6. Pull out the choke control lever to close the manual choke. An automatic choke closes itself. Open the throttle about one-fourth of the way.
7. Turn the ignition switch to ON. Operate the ignition switch or start switch to crank the engine and start it.
8. Do not crank the engine for more than 15 seconds at a time. Allow the starting motor to cool for 1 minute between cranking intervals.
9. When the engine starts, open the manual choke slightly until the engine runs smoothly. Continue to open the choke in small increments as the engine warms up. The choke should be fully open by the time the engine reaches normal operating temperature. Opening of the automatic choke is controlled by an electric heating element and manifold vacuum.

STOPPING

1. If the engine has been running hard, allow internal engine temperatures to equalize by idling engine for several minutes. This will minimize the danger of warping or cracking the cylinder head or block.
2. Turn the ignition switch to OFF to stop the engine.
3. If the ambient temperature is below freezing, and no antifreeze solution is used, the complete cooling system must be drained. This includes the cylinder block, water pump, radiator, and all hoses.
4. If antifreeze solution is used, check the solution with a hydrometer to make sure it is the strength recommended to provide protection below the lowest expected temperature.

COLD WEATHER STARTING

1. Check that the engine coolant has sufficient antifreeze to prevent freezing at the lowest temperature expected.
2. Refer to Lubricating Oil Specifications, to select the correct grade of engine oil. An oil that is too heavy for the temperature will prevent the starting motor from cranking the engine at the required speed.
3. Keep the fuel tank filled to reduce the amount of moisture which condenses in the fuel tank. If water contamination of the fuel is suspected, treat the fuel with a commercial gas line antifreeze or gasoline dryer. Frequently drain water from the fuel pump fuel bowl, if equipped, and from the carburetor float bowl.
4. Check that the batteries are fully charged and that all electrical connections are clean and tight.
5. After starting, open the choke more slowly in cold weather. If the choke is opened too rapidly, the engine will stumble or hesitate when the throttle is opened.

OPERATION

After the engine has started, make a thorough inspection of the engine unit to ensure that all parts are functioning properly. Proceed as follows:

1. Look at the oil pressure gauge. If insufficient pressure shows after the engine has run 10 to 12 seconds, shut down the engine and determine the trouble. With bearings in good condition and proper grade of oil being used, normal pressure should be 40 to 60 psi at operating temperature (170° F) and full engine speed. If the oil is very cold or heavy, this pressure may be much higher. As the oil heats, the pressure will diminish.
2. Check the coolant temperature; if it exceeds 200° F, shut down the engine and determine cause. Never operate the engine with the water at boiling temperature. This excessive heat on the cylinder walls will break down the oil film, causing rapid engine wear. Rapid coolant loss will result due to steaming.
3. Check ammeter charging rate. The ammeter should indicate a charge immediately after starting and should drop to near zero as the battery becomes fully charged. If the ammeter does not indicate proper operation, stop the engine and thoroughly check the engine charging system.
4. Check the engine for smooth, quiet operation and for proper exhaust condition. A cold engine may run erratically because a cylinder or two is firing irregularly. As the engine begins to warm up, however, all cylinders should fire regularly.
5. If rough operation continues, refer to Troubleshooting Section.

HIGH ALTITUDE OPERATION

1. At altitudes above 3000 feet, lower atmospheric pressure reduces engine efficiency and upsets the calibration of the carburetor. Make sure that the engine is properly tuned to reduce power loss at high altitude.
2. For additional information on specific cases, write to White Engines, Inc., Service Department, Canton, Ohio, giving as much information as possible. For recommended modifications to the carburetor, contact the carburetor manufacturer.

LONG-TERM STORAGE

If the engine is to be idle for a month or more, take special precautions as follows to prepare the engine so that rust will not form on the wearing surfaces or in the fuel system.

1. Engines which have been operating on leaded gasoline should be run on unleaded gasoline for at least 10 minutes in addition to the time it takes to run out the leaded gasoline in the fuel lines and carburetor.
 2. Continue to operate the engine until it reaches normal operating temperature. Stop the engine and drain all oil from the oil pan. Replace the oil filter.
 3. Refill the crankcase to the FULL mark on the bayonet gauge with a preservative lubricating oil meeting requirements of MIL-L-21260 (Gulf No-Rust Engine Oil, Grade No. 1 or 2; Shell Ensis MIL-L-21260, Code 66200 or Code 66202; or equivalent). Use SAE10 or SAE30, whichever viscosity is necessary to suit climatic conditions.
- NOTE:** It is recommended that preservative oil be used when the end unit is to be shipped with lubricating oil in the engine.
4. Remove the spark plugs. Fill a pump-type oil can with the preservation oil specified above and squirt about a teaspoonful into each cylinder. Reinstall spark plugs.
 5. Remove the cylinder head cover and side covers. Squirt or spray the pushrods, valve stems, tappets, and rocker arms thoroughly with preservative lubricating oil. Reinstall the covers, making sure the gaskets are in good condition.
 6. If the engine cooling system has not been winterized and/or rust treated, it should be flushed thoroughly with a water-soluble oil or other rust inhibitor to prevent rust formation.
 7. Disconnect the battery cables. Remove the batteries and store them, preferably where they can be recharged periodically since batteries tend to lose their charge when not in use.

LUBRICATION

8. Clean the entire engine exterior, except electrical system, with Diesel fuel oil or kerosene.
9. Release the fan belt(s) tension while the engine is in storage. Heavy paper strips inserted between the pulleys and belt(s) will prevent belt sticking.
10. Cover the ends of the exhaust pipe and air inlets with waterproof and vaporproof material so that moisture cannot reach the valve parts and cylinders. Store the engine where it will not be exposed to the elements, and preferably where it will be kept warm and dry. Moisture absorbing chemicals are available commercially for use when excessive dampness prevails in the storage area.
11. Coat unpainted exterior and interior surfaces of the air cleaner with preservative lubricating oil. If engines are stored with the clutch removed, coat the clutch contact surfaces, ring gear, and flywheel with oil. Rust-proof all accessories, such as air compressor and governor.
12. Periodically rotate the crankshaft while the engine is in storage. One-half turn every two weeks should suffice.
13. Periodically inspect the stored engine. Should there be any indication of rust or corrosion, take corrective steps at once to prevent damage to engine parts.

LUBRICATION AND PREVENTIVE MAINTENANCE

LUBRICATION AND PREVENTIVE MAINTENANCE SCHEDULE

To obtain long life and maximum efficiency from your White gasoline engine, set up and follow a definite maintenance program. The Lubrication and Preventive Maintenance Schedule, provides a recommended maintenance schedule which may be altered for a specific application or to fit into the user's own preventive maintenance program.

The daily instructions pertain to routine starting of the engine and not to a new or reconditioned engine or one that has been in storage. For a new or stored engine, follow instructions given in New Equipment Service and Initial Starting.

The time intervals of 50, 100, and 500 hours given in the Lubrication and preventive Maintenance Schedule, are actual operating hours of the engine. For engines used in road vehicles, the corresponding mileage — 1500, 3000, and 12,000 miles — are also given.

The Lubrication and Preventive Maintenance Schedule indicates the items which must be serviced and the required interval of service.



Illustration No. 2

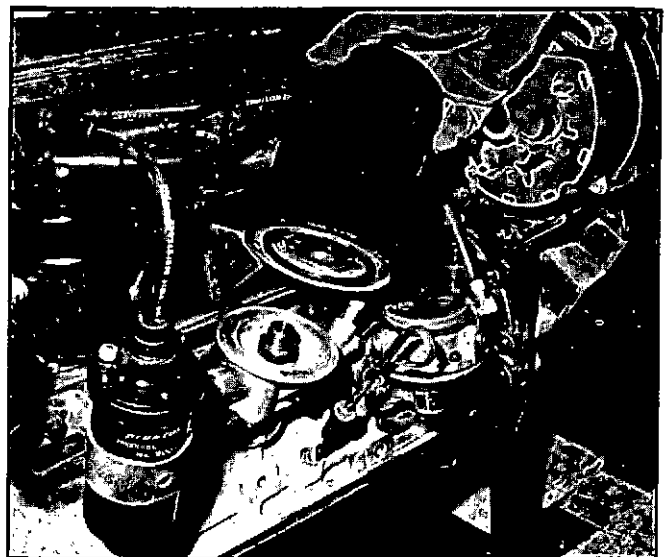

Illustration No. 3

WHITE ENGINES, INC.

ENGINE OIL AND FILTER

1. Frequency of oil changes depends on the application of the engine and the type of operation. An extremely clean operation could go 150 hours while a dusty operation could require service in 50 hours or less. It is recommended that new or reconditioned engines be started with 50-hour oil change periods. Under normal operating conditions, the change interval can be gradually increased to 100 hours.
2. Drain the oil after the engine has been operating and while the oil is hot. Remove the drain plug from the oil pan and drain the oil into a suitable container. Select the proper grade of oil in accordance with Recommended Lubricating Oil Specifications. Reinstall the oil drain plug and gasket and fill the crankcase to the FULL mark on the bayonet gauge. Illustration No. 2.

OIL FILTER

These engines are equipped with a spin-on full-flow oil filter which should be replaced with each oil change. This can be done as follows:

1. Remove and discard oil filter.
2. Apply a thin coat of engine oil to the rubber gasket on the new filter and screw it onto the adapter. Tighten the filter approximately one-half turn after the gasket contacts the filter base. See Illustration No. 3.
3. Add one extra quart of oil when refilling the crankcase to compensate for the oil in the filter. Check for oil leaks after starting the engine.

RECOMMENDED LUBRICATING OIL SPECIFICATIONS

AMBIENT AIR TEMPERATURE	VISCOSITY GRADE
-10°F to 30°F -----	10W
30°F to 60°F -----	20-20W
40°F and up -----	30
API classification -----	SD or SE

LUBRICATION AND PREVENTIVE MAINTENANCE SCHEDULE ENGINE TUNE-UP

OPERATION	HOURS MILES	TIME INTERVAL				REMARKS
		8 Daily	50 1500	100 3000	500 12,000	
Lubrication system						
Engine Oil		X		X	X	Include in Tune-up. Check level and refill.
Oil filter				X	X	Change oil (See Lubricating Oil Chart). Replace at every oil change.
Cooling system						
Coolant		X			X	Include in Tune-up. Check level daily.
Radiator			X			Remove dirt and debris from radiator fins; check for leaks.
Water Pump						Inspect and lubricate at engine over-haul.
Hoses					X	Inspect for leaks, cracks, and deterioration.

(X) Indicates that service or inspection is required.

OPERATING INSTRUCTIONS

Lubrication and Preventive Maintenance Schedule — Engine Tune-up (Con't.)

OPERATION	HOURS MILES	TIME INTERVAL				REMARKS
		8 Daily	50 1500	100 3000	500 12,000	
Fuel system						
Fuel bowl			X		X	Include in Tune-up. Clean fuel, water, and sediment from bowl (if equipped).
Fuel filters (if used)					X	Replace.
P.C.V. Valve (when provided)					X	Replace.
Carburetor					X	Adjust as required, service according to manufacturer's instructions.
Governor					X	Adjust as required, service according to manufacturer's instructions.
Fuel tank					X	Drain accumulated water and sediment from tank.
Air system						
Air cleaner		X	X	X	X	Include in Tune-up. Service air cleaner, service daily in dusty conditions.
Crankcase breather			X		X	Clean breather cap.
Electrical system						
Starting motor				X	X	Include in Tune-up. Lubricate with engine oil at oil cups (if equipped); service according to manufacturer's instructions.
Alternator				X	X	Adjust belt tension.
					X	Inspect for loose or broken wires and other damage; service according to manufacturer's instructions.
Battery			X		X	Check electrolyte level; refill with distilled or mineral-free water.
					X	Clean battery, cables, and terminals.
Ignition system						
Distributor					X	Include in Tune-up.
Spark plugs					X	Inspect, adjust, and set timing.
					X	Inspect and clean or replace.
Miscellaneous						
General condition		X			X	Include in Tune-up. Inspect for loose wires, leaking fuel or coolant lines, and loose mounting hardware.
Drive belts			X		X	Adjust belts to deflect $\frac{3}{4}$ inch under thumb pressure midway between pulleys. Retighten new belts after 2 hours of operation.
Engine compression					X	Check compression.
Valve clearance					X	Check and adjust valve clearance.

(X) Indicates that service or inspection is required.

TROUBLE SHOOTING

NOTE: Numbers in each column indicate sequence in which problem should be checked.	PROBLEM												
	Engine Will Not Start	Hard Starting	Engine Stops	Erratic Engine Performance	Black Exhaust Smoke	Blue Exhaust Smoke	White Exhaust Smoke	Low Power	Engine Over-Heating	Engine Over-Cooling	Engine Knocking	Low Oil Pressure	Bearing Failures
CAUSE													
Air Cleaner Dirty Air Inlet Restricted	11	4		1 2	1 2			1 2					
Exhaust System Restricted			6	13				13	10				
Battery Weak or Discharged Battery Cables Worn or Loose Connections	5 4	2 3	5	5									
Low Cylinder Compression Foreign Matter on Pistons Worn or Scored Pistons, Rings, Etc.		11 16		11 17 18	5			11 16 17	12	7 8			11
Valves Leaking or Sticking Worn Valve Guides Valves Incorrectly Adjusted	14 13	15 14		16 15		8		15 14		6 5			
Luboil Level Too Low Luboil Level Too High Luboil Contaminated Wrong Type of Luboil		1			1 3			3		1	1 4 3	1 3	1 2
Oil Pump Inlet Screen Plugged Pressure Regulator Not Functioning Rocker Arm Shaft Upside Down Oil Header Plug Missing or Loose Bearing Failed, Main, Rod, Cam.					6						6 7 5 10 8	8 9 12	
Excessive Angle Operation Excessive Thrust Pressure on Shafts	16	18	12			2					2 9	5 10	
Fuel Tank Empty Fuel Tank Valve Closed Fuel Tank Vent Plugged Fuel Pump Worn or Inoperative Fuel Contamination Fuel Incorrect For Conditions Fuel Filter Dirty or Plugged	2 3 12 6 7 8		1 2 3	6 10 7 8 9		4		10 4 5		2			
Ignition Switch In OFF Position Defective Points, Condenser, Coil or S. Plugs Ignition Timing Incorrect	1 9 10	10 9	7	4				8 7	7	3			
Throttle Linkage Adj. Incorrect or Sticking Carburetor Choke Closed Carburetor Malfunction Air Leak In Intake System			4 12 5	12 14 3	4 5			9 6 12	11				
Fan Belt Loose or Slipping Radiator Fins or Tubes Dirty or Restricted Water System Piped Incorrectly Low Coolant Level Coolant In Cylinders Inoperative Thermostat Thermostat Missing Internal Coolant Leak Wrong or Defective Radiator Cap	15	17		19			3 1 2			3 1 3 2			4
Engine Overloaded Engine Overspeeded				3				8 9		4		6 7	

GENERAL DESCRIPTION AND MAINTENANCE

This section covers a brief description and function of the various parts of the engine, along with instructions covering the repair, disassembly and reassembly of the various component parts of the engines.

This section has the various subjects arranged in associated groups, for convenience.

AIR SYSTEM

AIR CLEANERS

Dirt is the greatest enemy of any internal combustion engine and it is necessary to take every precaution to prevent it from entering the engine. This is accomplished by using an efficient dry-type air cleaner. When dirty, a restriction is created in the air intake, which may cause excessive exhaust smoke, loss of power, excessive fuel consumption, internal engine deposits and result in short engine life. Very little restriction, due to dirty air filters, is sufficient to create a very rich mixture; therefore, one of the most essential preventive measures is proper maintenance of the air intake filter. This unit should be checked at least once a day and, if operating in dusty conditions, may require cleaning or servicing even more often. Single, disposable element-style cleaners are used in normal applications. See Illustration No. 4.

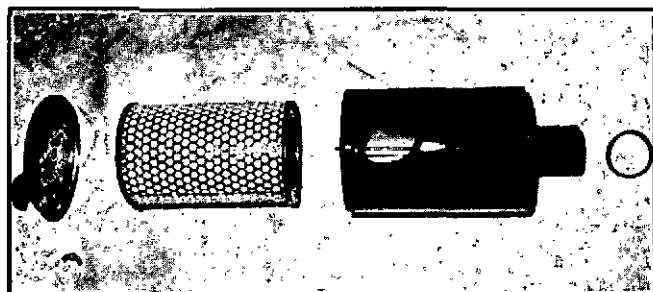

Illustration No. 4

All connections between the air cleaner and manifold must be absolutely air tight. It is possible, under certain conditions for enough abrasive laden air to be drawn into the engine, through a loose connection, to cause rapid wear of the pistons, rings and upper cylinder surfaces.

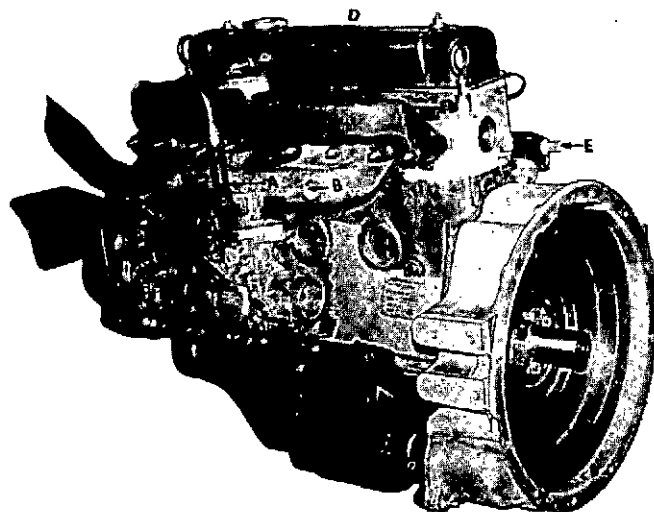

Illustration No. 5

NOTE: If a pre-cleaner is used it also must be removed and serviced regularly.

BREATHER

The breather and crankcase ventilation system allows clean air to enter, or accumulated gases to escape from the crankcase; the normal process of engine breathing.

The positive-type crankcase ventilation control (Emmission) consists of the following:
(See Illustration No. 5)

1. A crankcase ventilation metered control valve (A) mounted in the tube between the intake manifold (B) and the rocker arm cover (D).
2. An induction tube connector (E) on the oil filler tube cap, which connects with an air tube from the clean side of the carburetor air cleaner.

This insures clean air to the engine crankcase, reburning of the blowby gases and minimizes emission effect.

Both the ventilating valve and the air cleaner must receive frequent and regular attention to insure proper operation; the period depending on the kind of operation encountered. When servicing, remove the valve, disassemble, clean thoroughly in solvent and reassemble.

MANIFOLDS

The intake and exhaust manifolds are separate castings and can be installed or removed individually. Since one gasket is used for both manifolds it is advisable to remove both of them when either one must be removed, so a new gasket can be installed. In reassembling the manifolds to the cylinder head a flat washer is used under each nut and the nuts should be tightened progressively from the center, toward the ends.

A companion flange and gasket is used for installation of the exhaust pipe. Be sure these are drawn up tight and square with the exhaust flange.

Exhaust pipes and mufflers are designed of ample size to insure correct exhausting without excessive back pressure. When replacements are required they must be replaced with pipes and mufflers of equal exhaust capacity.

COOLING SYSTEM

Perhaps the best method for care of the cooling system is to clean and flush the system periodically; also, use a good rust corrosion preventive and a cooling system sealer between cleaning periods. Almost all natural water contains some mineral salts, which stimulate corrosion. The use of soft, or rain water is recommended, and water with permanent-type anti-freeze solution should be used in cold temperatures.

Add ½-pint water-soluble oil or other rust inhibitor to prevent rust formation when soft water is used alone.

Air leaks, around the hose connections at the radiator and the water pump, should be carefully guarded against, since oxygen is a major factor in promoting corrosion. Check the hoses and connections frequently for leaks.

If the engine or unit is equipped with a pressure-type sealed system it is imperative that the correct type of radiator cap be used. (7 PSI Pressure Release)

CHECKING COOLANT

Check Coolant level in radiator daily and maintain ½-inch below bottom of filler neck.

CAUTION: Loosen radiator cap ¼ turn to release pressure, before removing radiator cap.

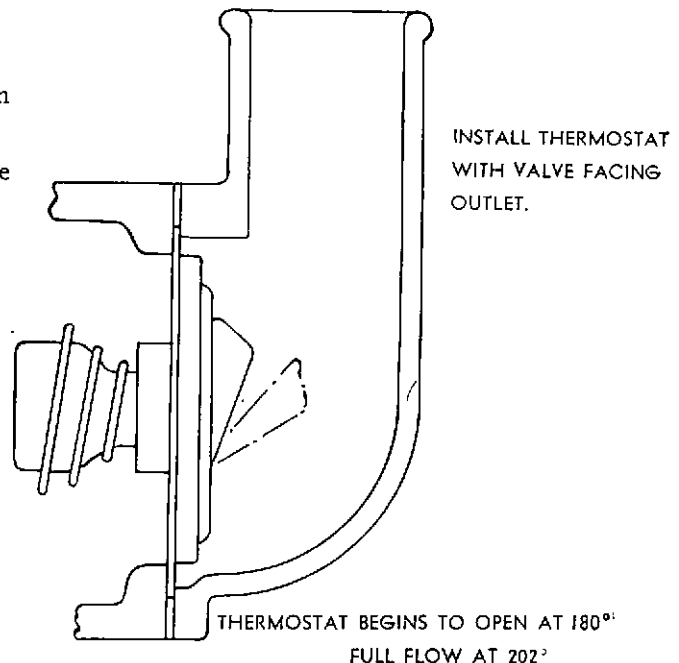

Illustration No. 6

THERMOSTAT AND HOUSING

The engine cooling system is equipped with the thermostatic valve (a), Illustration No. 7, designed to operate with the water pump to control the coolant flow and temperatures. Water circulates through the engine until the engine is heated to operating temperature, when the thermostat begins to open, permitting circulation through the radiator to maintain the proper heat range of 180° to 200° F. (+5°).

NOTE: A defective thermostat of this type must be replaced as it cannot be repaired.

THERMOSTAT REPLACEMENT

Drain coolant, disconnect radiator inlet hose from thermostat housing and remove thermostat housing cap screws. Remove thermostat housing, thermostat and gasket from cylinder head. Replace the thermostat, install a new housing gasket, reinstall the thermostat housing to the cylinder head and connect hose to thermostat housing.

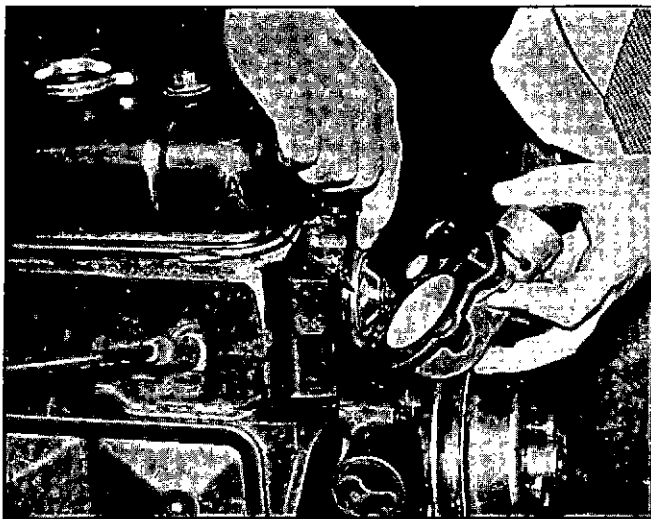

Illustration No. 7

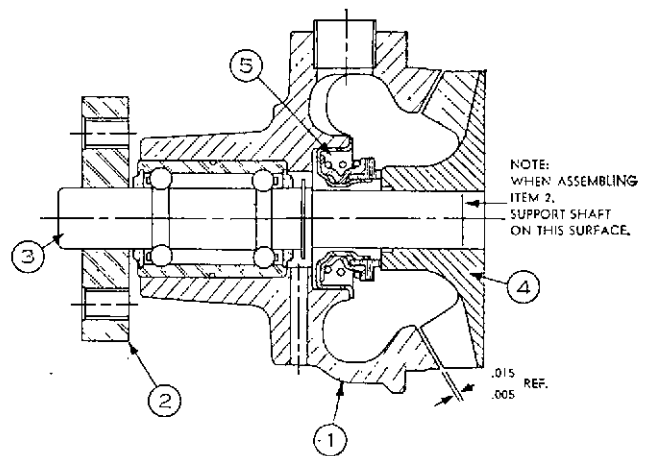

Illustration No. 8

WATER PUMP REMOVAL AND INSTALLATION

Drain the coolant and remove the side panels, fan and belt. Remove the pump attaching screws and lift the pump from the engine. Scrape all gasket and cement particles from the block and pump attaching surfaces.

Reinstall the water pump by reversing the removal procedures. Use Permatex on all attaching screws when installing the pump.

TO DISASSEMBLE WATER PUMP

(Numbers refer to Illustration No. 8)

1. Pull the fan and pulley hub (2) from the bearing-and-shaft assembly (3).
2. Reverse the pump housing and press the bearing-and-shaft assembly (3) from the impeller (4) and housing (1).
3. Reverse the housing again and using a proper size drift, press the seal assembly (5) out of the housing (1).

The shaft-and-bearing assembly (3) is one unit, and no attempt should be made to disassemble these parts. They are permanently lubricated at the factory, when assembled and sealed. If the shaft-and-bearing assembly shows any sign of wear, replace it. Wash and clean all other parts thoroughly and inspect for wear and damage. It is advisable to reface the seal surface of the impeller if it is grooved or otherwise marked. Put a coating of grease on the seal surface before starting reassembly of the pump. Inspect the impeller and pump housing for wear or scoring and replace, if required.

TO ASSEMBLE THE PUMP

1. Press the new seal (5) into the housing (1).

CAUTION: Press on the outer flange of the seal to avoid damaging the seal.

2. Press the shaft-and-bearing assembly (3) into the housing (1).

CAUTION: Press only on the outer bearing face of the bearing and not on the end of the shaft.

3. Supporting the pump shaft on the outer shaft end, press the impeller (4) on the shaft.

NOTE: The impeller is installed correctly when .005" to .015" clearance exists between the impeller and shaft housing, as shown in Illustration No. 8.

4. Support the pump on the impeller end of the shaft and press the fan and pulley hub (2) onto the shaft.

DO NOT PRESS ON THE IMPELLER as the clearance may be altered.

5. Test the rotation of the pump to see that it does not bind or have any excessive resistance.

When installing a water pump always use a new gasket and tighten the attaching screws evenly and alternately. Examine the water hoses and replace them, if necessary.

CAUTION: ALWAYS USE A WATERPROOF SEALANT ON ALL ATTACHING SCREWS WHEN INSTALLING THE WATER PUMP.

FANS — Low and High Mountings

On installations where a low mounted fan (Illustration No. 8) is used, the water pump fan drive pulley and fan are installed over the pilot diameter of the fan and pulley hub (2), and secured with the proper attaching screws.

To install the high mounted fan (Illustration No. 9), the fan pulley shaft and bearing assembly (3) is pressed into the fan pulley bracket assembly (6), then the fan pulley (7) is pressed onto the shaft and the complete assembly is attached to the thermostat housing with two attaching screws through the adjusting slots in the fan pulley bracket. The fan is installed on the fan pulley with four attaching screws. No lubrication is required for the low or high fan application.

The drive belt tension on the low fan can be adjusted by moving the alternator on the adjusting arm. Tension of the belt on the high mounted fan is adjusted with the adjusting screw (8) on the top of the fan pulley bracket.

Fans will vary in size or capacity to produce the correct air flow required to cool the engine, but all are carefully designed and balanced for use at speeds specified for the engine. Changes of fans, or speeds, should definitely not be made without consulting with the Engineering Department of White Engines, Inc.

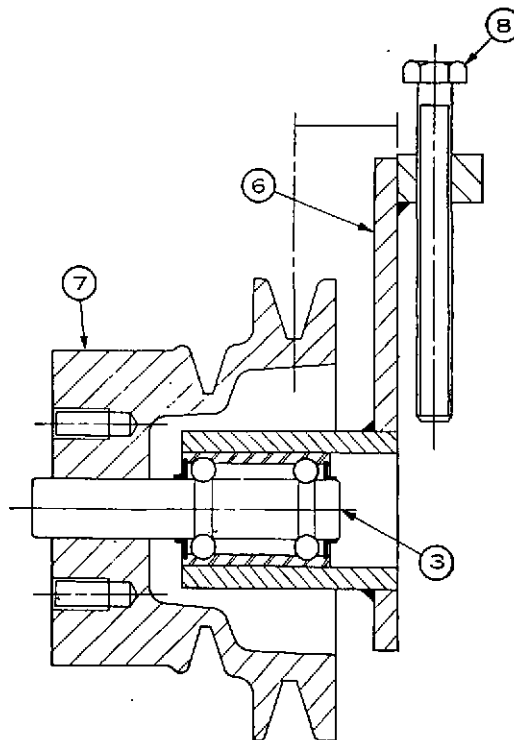

Illustration No. 9

If a fan shroud is used the fan blade should be positioned properly in order to get maximum efficiency. Two-thirds of the blade inside the shroud for suction-type, and one-half outside the shroud for pusher-type fans are normal positions for these engines.

LUBRICATING OIL SYSTEM

SYSTEM OPERATION

A positive pressure, gear-type oil pump draws the lubricating oil from the oil pan, through the sump screen, and directs it under regulated pressure to the oil filter. From there it is forced through a drilled passageway in the block and the center camshaft bearing to the hollow camshaft, which acts as the distributing oil header. The pressurized oil flows from the drilled camshaft and bearings to the crankshaft main bearings and connecting rod bearings. Also, a metered amount is directed to the rocker arm shaft for distribution to the rocker arms, valve stems and the oil pump drive gear at the camshaft.

The cam lobes, valve tappets, cylinder walls and other parts are lubricated by means of oil drain-back and the mist of oil, thrown off around the various pressurized lubricated bearings.

The predetermined oil pressure is maintained by a regulating valve, located in the oil pump body. With the lubeoil at operating temperature, the pressure is maintained at approximately 40 PSI. This may vary somewhat with the temperature and the SAE weight of the oil, as well as the engine speed. No adjustment to pressure is provided. (Refer to Illustration No. 10.)

Connection facilities for accessory lubrication or pressure gauges are provided for in the oil filter base.

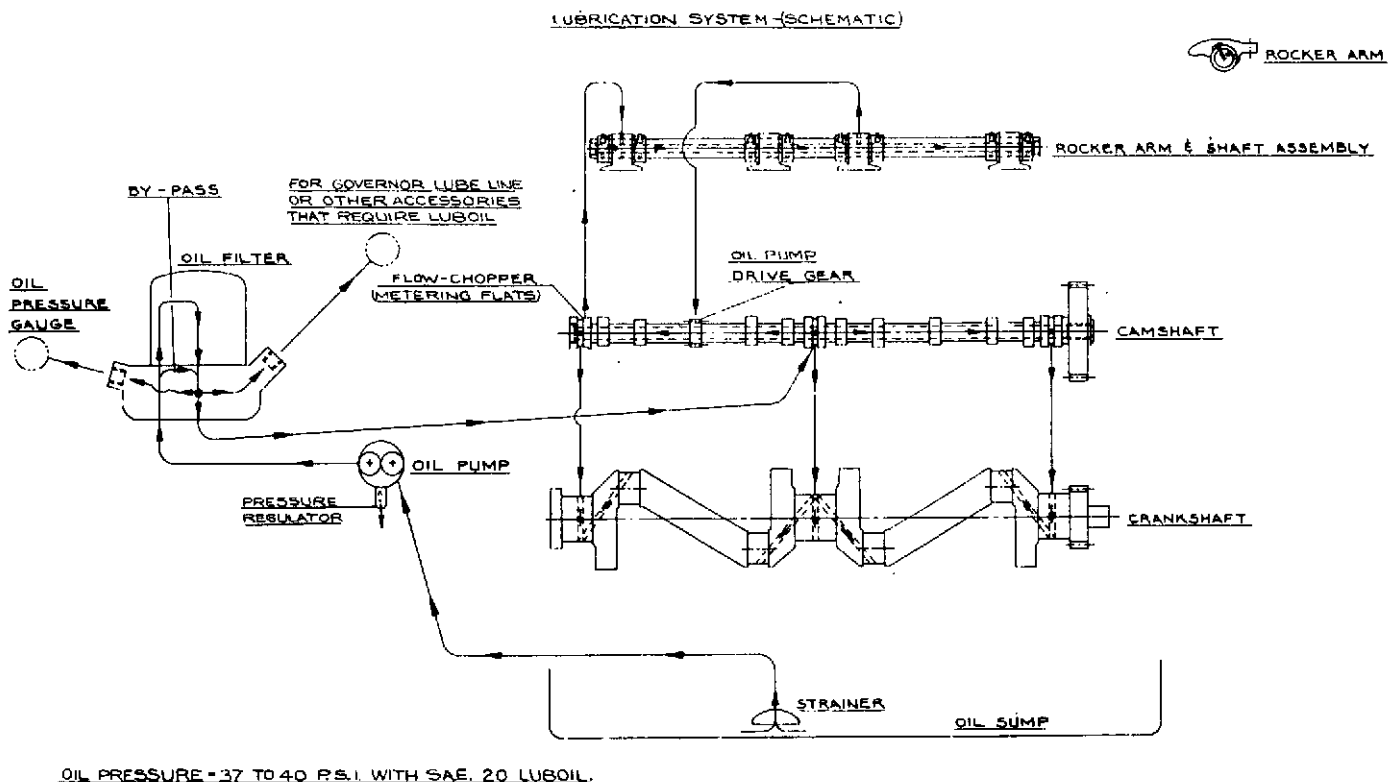

Illustration No. 10

OIL PAN — Removal and Installation

The oil pan, which serves as a cover for the bottom of the crankcase, as well as an oil reservoir, may be removed as follows:

1. Drain the crankcase oil and remove the bayonet gauge.

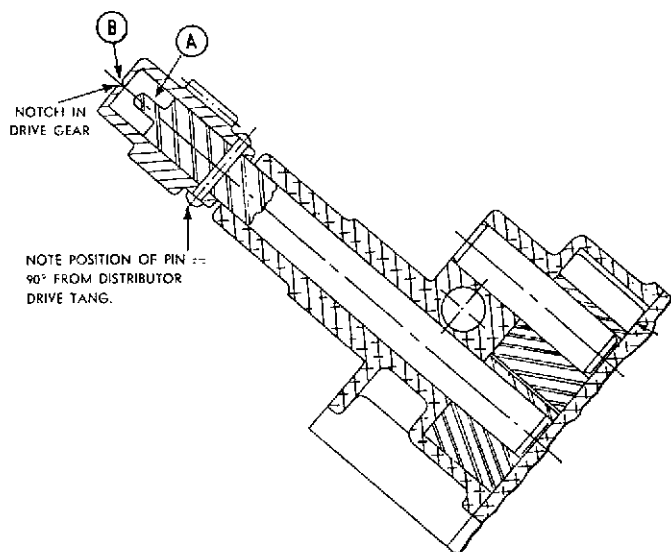

Illustration No. 11



Illustration No. 12

2. Disconnect the battery cable for safety; then, disconnect the starter cable and remove the starter.
3. Remove the oil pan attaching screws and remove the pan from the engine. Clean the oil pan thoroughly, inside and out, and remove the old gaskets and seals from the oil pan, cylinder block and front cover pan rails and the saddles on the front cover and rear main bearing cap.

Inspect the inside of the engine for loose nuts, screws, etc. Tighten or replace, if required.

TO INSTALL THE OIL PAN

1. Cement new gaskets on the oil pan and new saddle seals on the front cover and rear main bearing cap saddles, making sure of careful, proper installation. Illustration No. 1 (B-B) shows the correct installation of the saddle seals to insure against possible oil leaks.
2. Place the oil pan on the bottom of the engine and carefully start all screws and washers. Draw up the screws progressively, which permits the pan to center properly at both ends.
3. Install the drain plug and the bayonet gauge.
4. Install the starter and connect the electric cables.
5. Refill with proper lubeoil to the correct level.

LUBE OIL PUMP

The lube oil pump is attached to the bottom of the crankcase, as shown in Illustration No. 1. With the oil pan off it is easily removed from the engine as follows:

1. Turn the engine so that number one cylinder is at top dead center position and the distributor rotor at #1 terminal position. Then remove the distributor.
2. Remove the attaching screws and carefully pull the pump down out of the engine. Note that the distributor tang (A) of the pump shaft is practically parallel with the crankshaft, with the notch (B) in the gear towards the front of the engine. See Illustration No. 11.

TO DISASSEMBLE THE OIL PUMP FOR INSPECTION (See Illustration No. 11)

1. Remove the suction screen and line assembly and, then, the bottom cover assembly.

2. Remove the idler gear.
3. Drill the pin out of the distributor drive-and-shaft assembly, press the shaft out of the distributor gear and pull the shaft and driven gear from the pump body.
4. To remove the oil pressure regulator parts from the base plate, remove the cotter pin, spring seat, regulating spring and the piston, in this order. (Note the position of the piston in the base plate, so it will be properly reinstalled).

Inspect all the parts carefully for cracks, scores, wear, excessive clearance, etc. If any of the parts show excessive wear or are in doubtful condition, discard the entire pump assembly and install a complete new one, as repairs are not recommended.

If the pump is found in proper and usable condition it may be reassembled and installed in the reverse order of the above removal and disassembly sequence.

NOTE: When reinstalling the oil pump in the engine, spot the engine on number one cylinder. The gear and shaft should be positioned with the distributor drive tang of the shaft parallel with the crankshaft so that the distributor rotor will properly index with #1 terminal, when the distributor is installed. See Mark "B", Illustration No. 12.

LUBE OIL FILTERS

(Refer to "Lubrication" Section and Illustration No. 10)

FUEL SYSTEM

The fuel system includes an ample-size, vented fuel tank, a sediment bowl or water trap, supply pump, the carburetor and the fuel lines necessary to connect the component parts.

Also, since the power and speed control of the engine are dependent upon the operation of the carburetor throttle levers, we include the governor and linkage in this group. Illustration No. 13 shows the carburetor and governor and linkage.

CARBURETOR

A carburetor is an accessory, designed to mix gasoline and air in proper proportions and to furnish this proportionate mixture to the engine under varying operating conditions.

It is essential to clearly recognize that the function of the carburetor cannot extend beyond the proportionate mixing of fuel and air. This knowledge will avoid many false leads in diagnosing so-called "carburetor troubles".

The carburetor and all of its carefully designed and balanced jets, floats, passageways, compensators, chokes and internal adjustments are determined and established at the factory, only after extensive and exhausting tests to determine the correct air fuel mixture for all loads and speeds of the engine. **NO TAMPERING OR CHANGES** by inexperienced or unauthorized persons should be tolerated by any operator, as serious damage can result.

If internal or major service is needed the work should be done only by an authorized carburetor service center. They have the specifications, correct parts and know-how to restore it to factory specifications and to insure proper operation.

The maintenance man must be sure all linkage, throttle levers, choke connections, etc., are kept properly adjusted and tightened, so that full throttle and choke action is maintained. Also, air cleaner or hose attaching parts must fit and be kept air tight, as described under "Air Cleaner."

FUEL PUMP

The fuel supply pump used on these engines is the diaphragm-type, operated by a rocker arm, actuated by an eccentric on the camshaft and mounted on the right-hand side of the engine.

In a great majority of cases trouble attributed to the fuel pump is generally caused by failure in some other part of the fuel system, therefore be sure that the trouble is actually in the fuel pump, before

removing it for inspection or repair. For instance, if the engine is not getting enough gasoline, check the level of the fuel in the fuel tank and check for broken, leaking or clogged fuel supply lines. Then, before removing the fuel pump from the engine, check for a leaking bowl gasket, loose diaphragm or top cover screws or bad valves and springs.

If the engine is getting too much fuel this is usually caused by a defective choke arrangement, punctured carburetor float, defective carburetor needle valve or improper carburetor adjustment; this is generally not caused by the fuel pump.

TO TEST THE FUEL PUMP

Before installing the fuel pump it is always desirable to test it. This can be accomplished as follows:

1. Hook the fuel supply line from the tank to the pump inlet connection.
2. Holding the pump in hand, work the rocker arm, using long, even strokes. After quite a few strokes the bowl will fill with fuel and, after it is filled, a few more strokes will force it through the pump and out the outlet side.
3. With strokes approximately $\frac{1}{4}$ " to $\frac{1}{2}$ " at the tip of the rocker arm the pump should be able to deliver quite a bit of fuel. If it does not, with these short strokes, this would indicate that the pump requires servicing and should be taken to an authorized Service Station.

GOVERNOR — MECHANICAL TYPE — EXTERNALLY MOUNTED

The governors used for this engine may vary from the velocity type, mechanical maximum speed type, mechanical variable speed type or others. The most commonly used is the maximum or constant speed centrifugal weight types, externally mounted on the gear housing plate and gear driven from the idler gear, as shown in Illustration No. 13 and No. 14.

The "constant speed" type is used where it is necessary to operate equipment at one predetermined governor controlled speed, regardless of power required (within the limits of the engine) to drive the equipment at desired speed.

NOTE: If the governor is to be used as a "constant speed" control, a loose lever arrangement and manual control mechanism should be utilized to over-ride the governor and return the engine to idle speed, prior to stopping the engine. Lever (B) is hinged at the bolt shown, but is held straight by a spring (A). This arrangement permits manual over-ride of the governor with minor effort, but returns to full governor control of the engine, when the manual control is moved to wide open throttle position. The "variable speed" type is used where it is necessary to change equipment speed and retain full governor control of the engine speed (within the limits of the engine and governor).

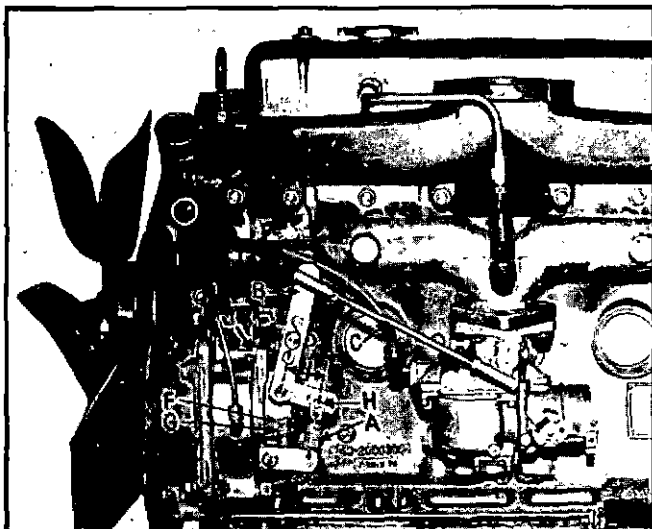

Illustration No. 13

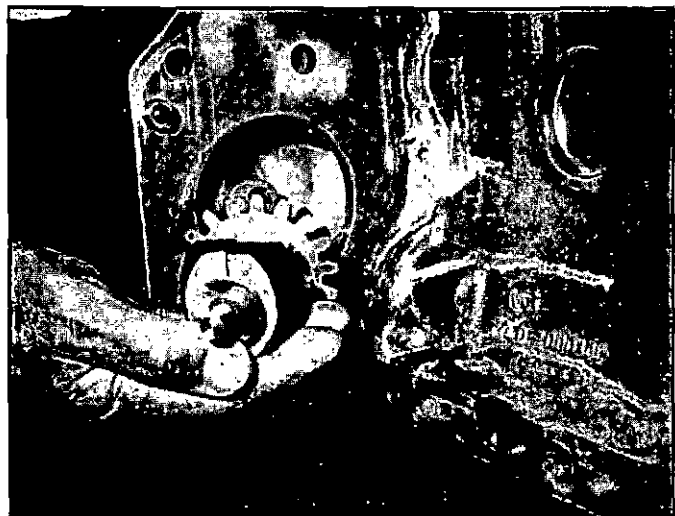

Illustration No. 14

DESCRIPTION AND MAINTENANCE

To adjust governor for constant speed:

1. With engine stopped the tension of spring (A) holds lever (B) in full throttle position, as shown.
2. Adjust length of rod assembly (C) to obtain $\frac{1}{32}$ " — $\frac{1}{16}$ " clearance between throttle stop pin and lever on back side of carburetor.
3. Start engine, attach speed indicating tachometer and open throttle while noting engine speed.
4. Turn screw (F) in (Clockwise) to increase speed, out (Counter-clockwise) to decrease the engine speed.

WARNING: Do not set the maximum engine speed above that specified by the equipment manufacturer. To do so will invite possible equipment destruction or bodily harm.

5. After correct speed is obtained lock the screw with the lock nut (G).
6. Spring eye clip and bolt (H) are utilized to adjust the sensitivity of the governor. Lengthening the distance (I) from the center of shaft to center of spring eye will decrease the sensitivity of the governor action, but will increase over-run (difference between full-load and no-load engine speed).

Shortening the distance (I) will increase sensitivity of the governor, but if shortened too much, it will tend to cause surging or hunting; therefore, the desired adjustment of this screw is to obtain minimum over-run without inducing a surging condition.

7. Adjusting (bumper) screw (J) is used to dampen high-speed surging. Turn this screw in slowly until the surge is just dampened. Then recheck the throttle closed or idle position. If the governor will not allow the throttle to close, back this screw out and readjust the sensitivity adjustment as outlined in paragraph 6.

TO REMOVE GOVERNOR

If necessary to inspect or repair governor, it can readily be removed for this purpose. Disconnect the oil line, if used, and governor control rod. Remove the two cap screws and lift governor cover assembly away from engine, then pull governor shaft, weight and gear assembly back out of engine. Illustration No. 14.

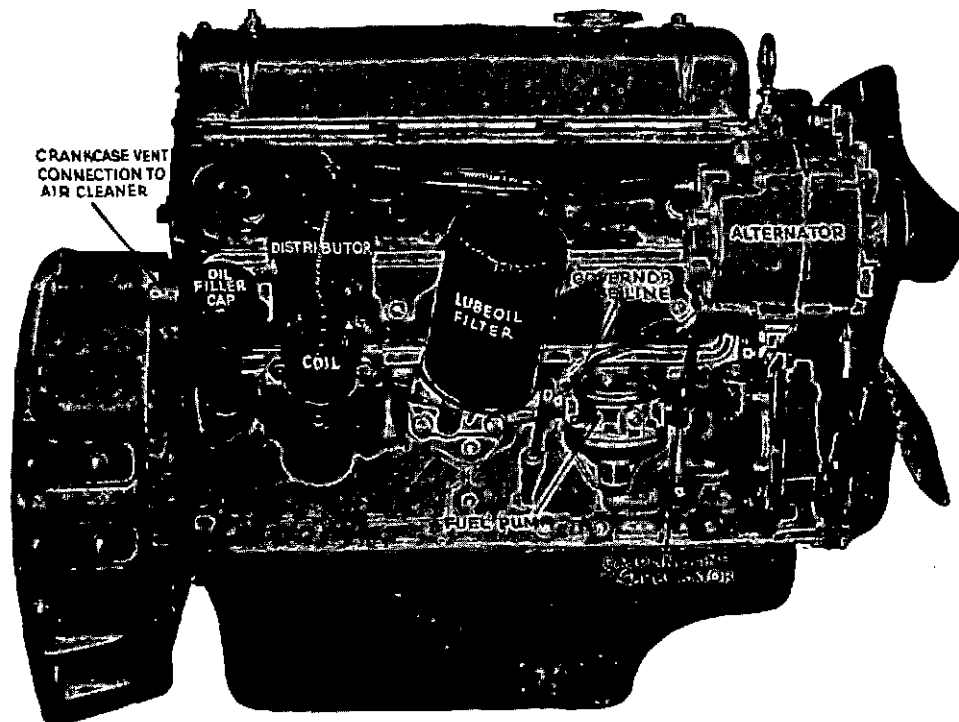

G-1600

INSTALLATION OF PIERCE GOVERNOR

Pierce Governor Kits, numbered 40-2065159, 40-265150 and 40-2065161, according to governor speed, are available to replace Hoof Governors on the G-1600 engines, **INSTALL AS FOLLOWS:**

REMOVAL OF HOOF GOVERNOR

1. Disconnect cables from battery and starter remove starter.
2. Disconnect governor rod at governor and fuel line and choke cable from carburetor.
3. Remove manifolds, leaving carburetor attached to intake manifold.
4. Remove the Hoof Governor and adapter.

INSTALLATION OF PIERCE GOVERNOR

1. Position Pierce Governor in the pilot against rear of front plate and spot location of the two mounting holes. Make sure the throttle arm (1) Illustration No. 15 is about $\frac{1}{8}$ " from the lower gear housing attaching nut (2) to assure sufficient clearance.

CAUTION: (Prior to drilling) — Place a cloth in the gear housing to prevent metal chips from getting into engine when drilling holes as described in Paragraph No. 2.

2. Drill and tap the two holes (A) and (B) in front plate where spotted, with a $\frac{5}{16}$ " drill and $\frac{3}{8}$ "—16th. tap and install governor.
3. Install the manifolds using a new gasket.
4. With the carburetor throttle wide open, move the throttle control arm (3) to approximately the 11:00 o'clock position.

When installing governor control (5), use an equal amount of threads in each balljoint (6) to obtain a $\frac{1}{32}$ " to $\frac{1}{16}$ " clearance between the carburetor lever and stop at wide position. Tighten lock nuts (4) on rod.

5. Make sure when manually operating the governor rod the carburetor level positions against the stop screw at idle.
6. Install cables to starter and battery.
7. Engine is now ready to start and adjust governor for specified setting.

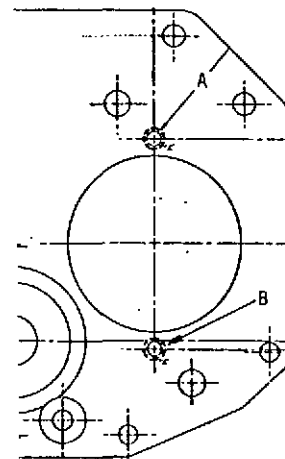
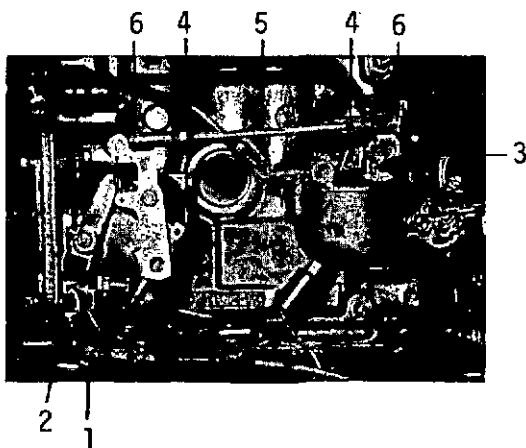

Front Plate

Illustration No. 15

ELECTRICAL SYSTEMS

Due to the many types of electrical equipment used and the variety of requirements with different installations and manufacturers it is possible to illustrate only typical, basic wiring diagrams, such as Illustration No. 16

ELECTRICAL ACCESSORIES

A periodic inspection should be made of the components of the Electric System. The intervals between these checks will vary, depending upon the type of service.

A visual inspection should be made of all wiring to insure that there are no broken wires, and that all connections are clean and tight. Special attention should be paid to the ground connections at the battery and alternator.

CAUTION: If a new regulator unit is required the new replacement regulator should be exactly like the original one.

When service or repairs are required they also should be done only by Authorized Service Depots or qualified personnel.

BATTERY RECOMMENDATIONS

If a 12-volt battery is not furnished with the unit procure only those of a good brand and with the following capacity: 210 ampere-hours, 12-volt, 25-plate.

CAUTION: The size and capacity of the wires and terminals used in all wiring circuits are as important as the electrical units themselves. Undersize wires or terminals, poor insulation, loose or corroded connections, etc., may cause severe troubles or failures in the system.

CHECKING ELECTROLYTE

Check liquid level in battery cells weekly. Maintain level $\frac{1}{4}$ " to $\frac{3}{8}$ " above battery plates, or as recommended by battery manufacturer, by adding clean water, whenever necessary. Use a syringe to avoid overfilling. Charging the battery may be necessary if water is added in freezing temperatures. Battery acid with specific gravity of 1.165 will freeze at zero degrees Fahrenheit. It is recommended that the specific gravity of battery electrolyte be checked with a hydrometer every 30 days. Recharge battery if reading below 1.250 is obtained.

CAUTION: If battery electrolyte contacts skin or clothing, it must be neutralized immediately with baking soda or flushed thoroughly with water.

BATTERY CHARGING SYSTEM

The battery charging system consists of an alternator which creates the electrical current, a regulator to control the current, an ammeter to indicate the amount of current being created or used, and the battery, also the necessary wires and connections.

Immediately after the engine is started the ammeter should show a high charge rate that will decrease as the battery recovers, if no accessories are in use, such as lights, fan motors, etc.

If the charge rate remains high and the battery continually boils away its water, the voltage regulator should be checked. Consult the manufacturer's literature for procedures and settings.

NOTE: Since the unit is equipped with an alternator, care must be taken when using "jumper cables" to see that correct polarity is maintained. Reversing the battery connections, even for an instant, will destroy the alternator's diodes and make it inoperative. It is also important that the battery not be removed while the machine is in operation because this too can destroy the diodes.

REMEMBER: Service or repairs should be done only by Authorized Service Depots or experienced personnel.

THE STARTER SYSTEM

Because the starter motor requires a great deal of current to crank the engine, care must be taken to see that the wires from the starter to battery and the battery ground strap are kept clean and tight.

ELECTRICAL SYSTEMS

IGNITION SYSTEM

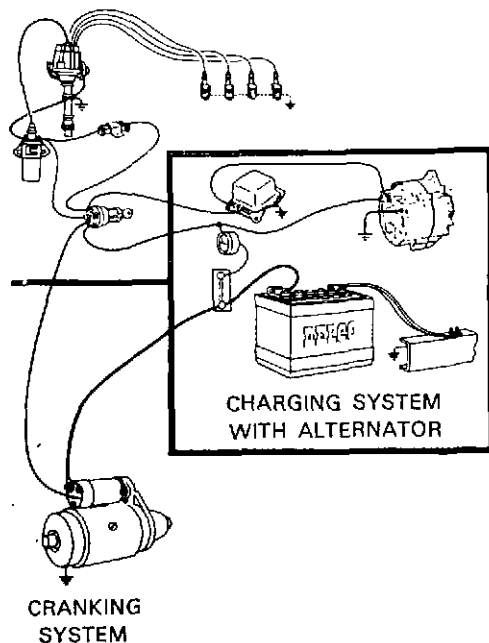

Illustration No. 16

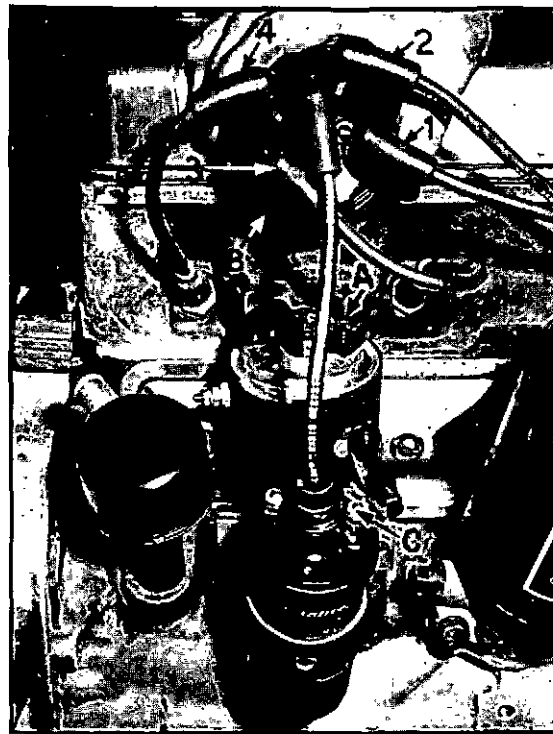

Illustration No. 17

The starter is usually controlled by a magnetic switch or solenoid connected to the ignition switch or a starter button on the control panel. If the starter fails to operate properly, when the battery is known to be fully charged, this switch circuit should be checked for loose wires or a poorly grounded magnetic switch.

NOTE: Do not operate the starter motor for more than 15 seconds without allowing at least one minute for it to cool.

IGNITION SYSTEM

All wires in this system must be kept in excellent condition to assure full engine efficiency. Even small amounts of corrosion or cracks in the insulation will cause misfiring, especially during damp, cold weather.

The distributor cap should be checked periodically for cracks or carbon traces and replaced, if any are found.

When constant hard starting is encountered, a check should be made to see if the coil is getting at least 9V, while the starting motor is operating (4V. on a 6V. system). If the coil input voltage is too low, it cannot supply adequate voltage to the spark plugs for easy starting.

IGNITION TIMING (Battery)

The distributor is driven from the oil pump by a tang and groove type arrangement. To install the distributor check to be sure the notch on the oil pump gear (Shown as "B", Illustration No. 12) is to the front of the engine. To determine whether the engine is in firing position for No. 1 cylinder, the engine can be cranked, with the spark plugs removed, to locate the compression stroke of No. 1 cylinder.

SPOTTING THE ENGINE ON TIMING MARKS

With the ignition points clean and making a square contact, and set to the proper gap opening of .018" to .020", turn the distributor rotor (A), Illustration No. 17, to the No. 1 cylinder firing position on the distributor cap (B) and insert the distributor into the cylinder block and over oil pump shaft tang.

ENGINE TIMING AT 6° BTDC

Set idle at 800 RPM and use a timing light to align timing mark (A) on pulley with pointer (B) on gear cover. Illustration No. 18.

NOTE: ON APPLICATIONS WHERE THE ENGINE CANNOT BE IDLED AT 800 RPM THE FOLLOWING WOULD APPLY.

ENGINE TIMING AT 18° BTDC

Set engine at 1800 RPM and use a timing light to align timing mark (C) on pulley with pointer (B) on gear cover. Illustration No. 18.

BASIC ENGINE AND PARTS

CYLINDER HEAD, VALVES AND ROCKER ARMS

ROCKER ARM ASSEMBLY AND PUSH RODS REMOVAL

Disconnect the crankcase ventilation tube from the rocker arm cover. Remove the cover attaching nuts and seals and remove the cover. Remove rocker arm support cap-screws, nuts, washers, oil tube brackets (clips) and the oil tubes and lift the rocker arm assembly from the head. Remove push rods from engine and check for straightness.

DISASSEMBLY

(Refer to Illustration No. 19)

Remove cotter pins from ends of shaft and slide off washers, rocker arms, supports and springs.

Remove plugs from ends of shaft, if leaking.

ASSEMBLY

Install new plugs in ends of shaft, if required.

Install springs, rocker arms, supports and washers on shaft. Insert cotter pins in holes near ends of shaft and bend ends of cotter pins to lock.

INSTALLATION

Install push rods in valve tappet sockets. Install rocker arm assembly. Replace O-ring (19) on oil tube "A" and install oil tubes A and B. See Illustration Nos. 19 and 20. Install washers, oil tube brackets (clips), nuts and capscrews and tighten to specified torque tension. Adjust valve clearance to "Specifications". Illustration No. 21.

Check valve rocker arm cover gasket (replace if necessary) and install the rocker arm cover, seals and nuts.

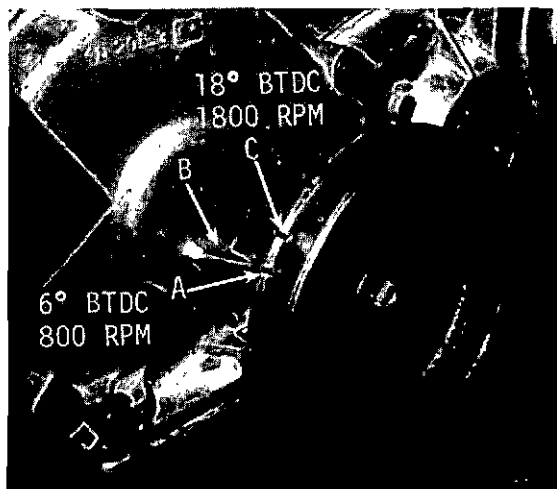

Illustration No. 18

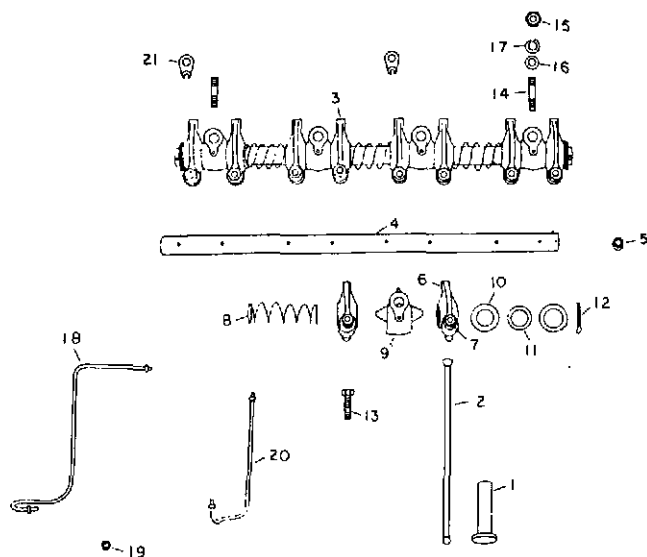

Illustration No. 19

CYLINDER HEAD AND VALVES

REMOVAL

If engine has not been removed, drain coolant from radiator and block. Remove the spark plug cables and spark plugs.

Disconnect water temperature gauge sender. Remove crankcase ventilation parts, carburetor and linkage and the intake and exhaust manifolds. Remove cylinder head cover, oil tubes, rocker arm assembly and push rods. Remove water hose, thermostat housing and thermostat.

Remove cylinder head capscrews and lift cylinder head from cylinder block. Remove cylinder head gasket and clean gasket surfaces on cylinder head and cylinder block thoroughly.

DISASSEMBLY

Remove lifting eyes from cylinder head. Compress valve springs and remove caps, keys and locks. Release springs and remove retainers, springs, seals and valves. Place valves in a rack to insure reassembly in original positions.

INSPECTION

VALVES

Discard burned, warped, bent or worn valves. Examine seats for wear.

CYLINDER HEAD

Clean water jacket of excessive scale. Inspect for warpage, scores, scratches or nicks. Check to see if the locating dowels are in place and clean.

VALVE GUIDES

Check valve guide bores for wear. Examine port end of guide for bell mouth condition. If the guide bores in the head are worn beyond limits, the heads may be machined, and valve guides inserted and reamed to proper size. They must be positioned and machined to exactly the same guide length as the original guide provisions.

VALVE SPRINGS

Check valve springs for proper pressure.

VALVE REFACING

Valve margin, face angle and runout are shown in "Specifications". Reface valves in conventional manner.

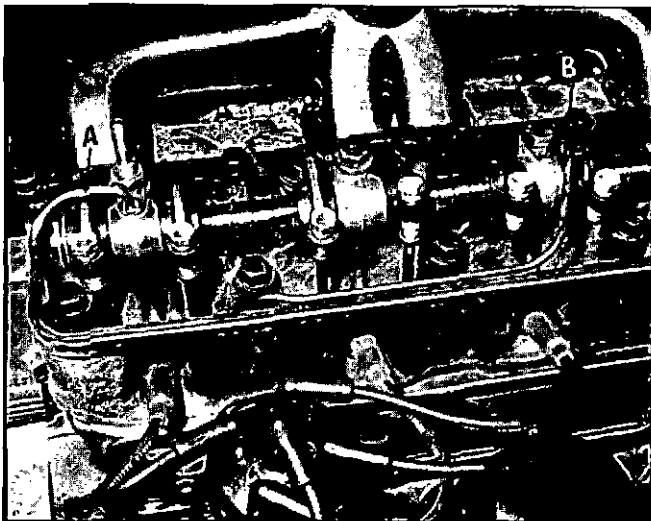

Illustration No. 20

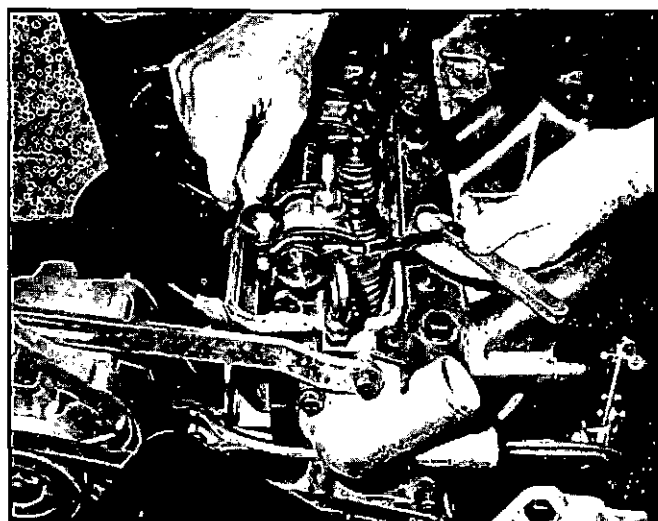

Illustration No. 21

VALVE SEAT REFACING

Valve seat angle, runout and width are shown in "Specifications". Seat should contact valve at approximately center of valve face.

Hand lapping valves is not recommended; however, light hand lapping is permitted to determine valve and seat contact. Do not lap excessively. If more than a few strokes are required, valve should be removed and more accurately ground.

Check the clearance between cap and valve tip if used with the spring, retainer, and valve locks assembled.

Valve locks and tip caps, once fitted, must be kept in respective groups and valve locks that are worn must be replaced.

ASSEMBLY

Install intake and exhaust valves, springs and retainers. Compress valve springs and install locks and keys. Install exhaust valve cap, if used. See Illustration No. 22.

NOTE: Starting with Engine Serial Number 4907856 and all engines thereafter the valve arrangements were changed as shown in Illustration No. 22. Valve removal and assembly may be accomplished as outlined above.

The valves and related parts used on engines prior to Serial Number 4907856 may be replaced with Service Kit Number 40-202551, intake valve and 40-202552, exhaust valve. All valves and parts are to be changed on the initial changeover.

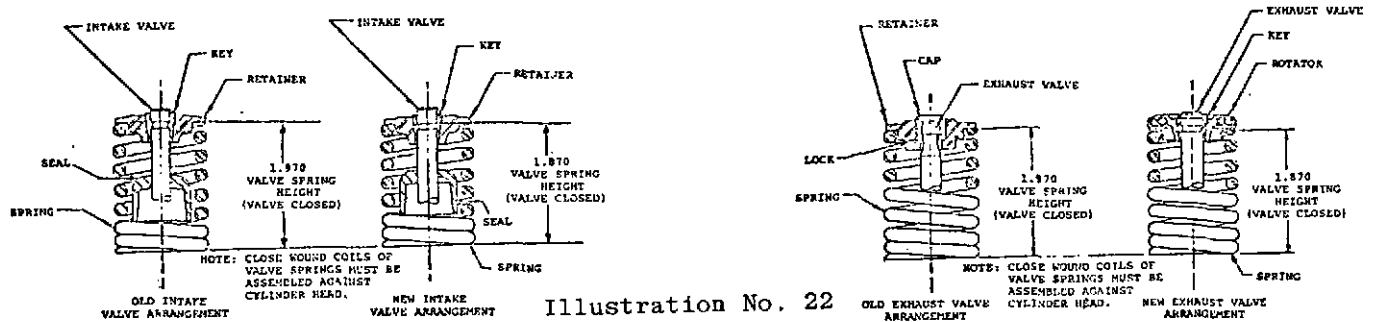

Illustration No. 22

Progressively tighten cylinder head bolts in number sequence as shown.

1. Torque - 45-55 ft. lbs. (Power Production Wrench)
2. Torque - 60-65 ft. lbs. (Hand Torque Wrench)

Torque values apply to bolts with lubricated threads. (Preservative oil acceptable).

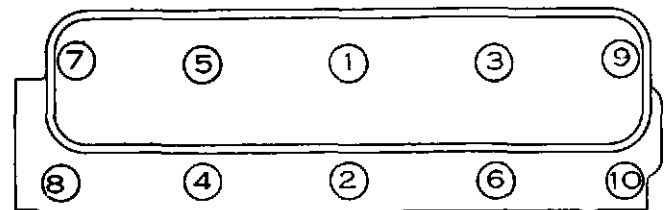

Illustration No. 23

INSTALLATION

Make sure mating surfaces on head and block are absolutely clean and install new head gasket on block. Install cylinder head on block and secure with the capscrews. Use a torque wrench and tighten screws to specifications, using sequence as shown in Illustration No. 23. Install the push rods, rocker arm assembly and the lube tubes "A" and "B", Illustration No. 20. Adjust the valve tappet clearance to specifications.

NOTE: Retighten the cylinder head capscrews and reset valve tappet clearances after 25 to 40 hours of operation.

Install valve rocker arm cover, using new gasket. Install intake and exhaust manifolds, thermostat, thermostat housing, water hose and crankcase ventilation tube. Connect wire to water temperature gauge sender, install spark plugs and wires, and refill engine and radiator with coolant. Install carburetor and linkage.

DESCRIPTION AND MAINTENANCE

CYLINDER BLOCK

The cylinders and crankcase are an integral unit, with the water jackets carried the full length of the piston travel for more uniform cooling of the cylinder walls and the pistons.

Material is gray cast iron and an inspection of the block shows the very rigid construction provided to support the large diameter crankshaft. This results in a very rugged and smooth running engine.

The cylinder block has various passageways, drilled to carry oil from the oil pump to the camshaft, and bearings, to the main bearings, and through the cylinder head to the rocker arms. See Lube Section and Oil Flow, Illustration No. 10.

All oil passages should be thoroughly cleaned with a wire brush and solvent at overhaul time.

To replace the main bearings, see "Main Bearings." Also, provisions for the rear oil seal are machined in the cylinder block and rear main bearing cap.

Core openings are closed by expansion type or threaded plugs. If any should leak, remove and replace with new plugs.

IMPORTANT: Camshaft bearing installation requires special attention to insure the lube holes register properly with the correct holes in the cylinder block. Illustration No. 24 shows the proper location of each bearing. The holes in the bushings must be diagrammed to match perfectly, or oil flow restriction will result, which may cause damage to the engine. When installing new bearings, if they do not register properly when pressed into place, remove them and reinstall them properly.

After the rear cam bearing is installed a cup plug is driven into the rear of the cylinder block in order to seal the oil off. The plug keeps the oil from the bearing from escaping into the area between the block and bellhousing. Illustration No. 25 shows the cup plug (A) being installed, using a proper driver (B).

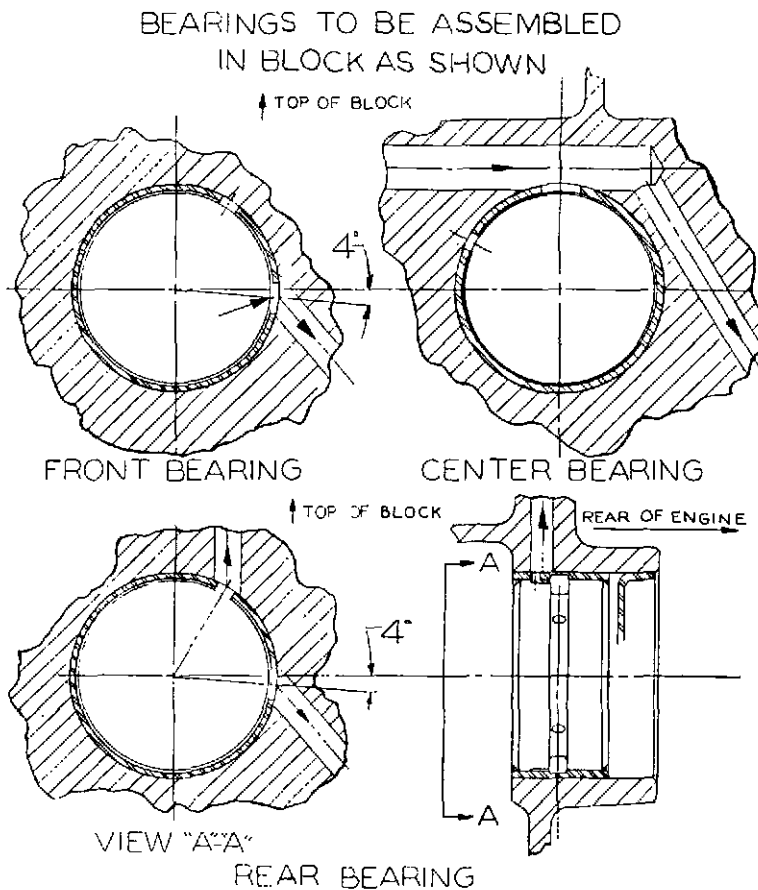

Illustration No. 24

CRANKSHAFT, BELLHOUSING AND FLYWHEEL

FLYWHEEL REMOVAL

Remove the engine clutch, other drives or couplings. Disconnect electric cables and remove the starter. Remove upper one of six capscrews and install a $\frac{7}{16}$ -20 x 4-inch long guide stud to aid in sliding the flywheel from the bellhousing when the remaining screws are removed.

Mark the position of the flywheel in relation to the crankshaft mounting flange, before removal. Remove the remaining screws and slide the flywheel from the housing.

Inspect the flywheel for cracks, scores, enlarged or fretted attaching screw holes, etc. Inspect the ring gear for broken, chipped or mashed gear teeth. Repair or replace, as required; brush and clean all foreign material from surfaces.

FLYWHEEL INSTALLATION

Install the guide stud. See Illustration No. 26. Align the position marks made on the flywheel and crankshaft flange and carefully lift and slide the flywheel into place on the crankshaft flange. Install the capscrews; remove the guide stud. Progressively tighten the attaching screws with a torque wrench to 80 ft. lbs. Using a dial indicator, such as shown in Illustration No. 27, indicate the face and pilot bore of the flywheel. This should be within .005-inch total indicator reading. Install the starter and electric wires and then the clutch, transmission or power take-off, as removed.

When a stub shaft is attached to the flywheel to be used as a drive unit, it should also be indicated as in Illustration No. 28.

BELLHOUSING

The bellhousing is a casting which covers the rear end of the cylinder block. There are many types of housings used, some of which may be a plate-type housing and others which form a complete housing for the flywheel and clutch to which the transmission, torque converter or other drive mechanism is attached. The bellhousing usually forms the rear motor support and provides the mounting and support provisions for the starting motor.

TO REMOVE THE BELLHOUSING

1. Remove the clutch or power take-off mechanism and electric starter.
2. Remove the flywheel, see "Flywheel".

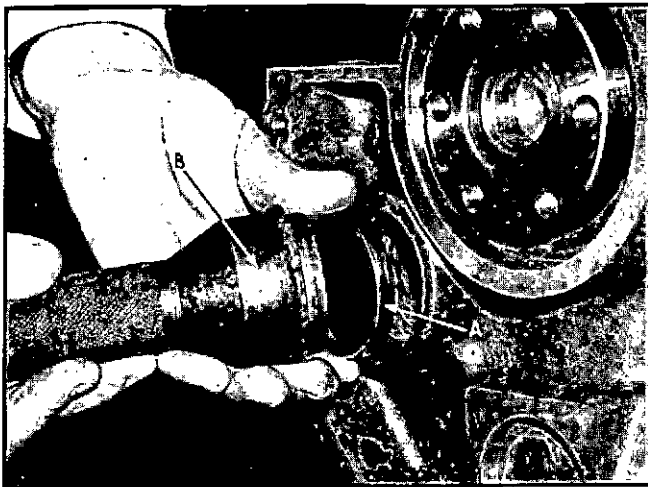

Illustration No. 25

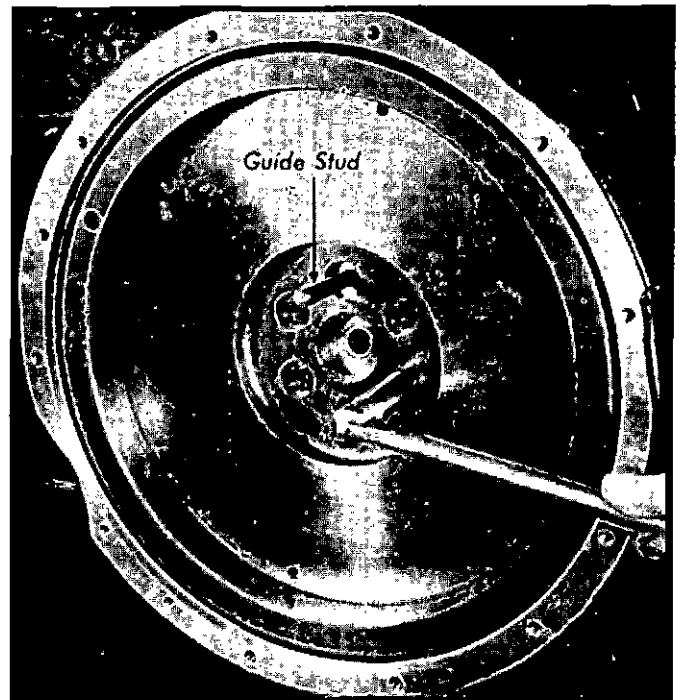

Illustration No. 26

3. If the engine is in the unit place suitable supports under the rear of the crankcase to support the engine.
4. Remove the rear motor support screws.
5. Remove the bellhousing attaching screws and lock washers.
6. Pull the bellhousing away from the engine; it may be necessary to tap the housing with a soft hammer to loosen from the dowels or gaskets sticking to the block.

TO INSTALL THE BELLHOUSING — See "Note" and Torque Sequence below

Reverse the above procedure and using a dial indicator like that shown in Illustration No. 27 (under "Flywheel") check the runout of the bellhousing pilot bore and face. This should not exceed $\pm .005$ ".

NOTE: The two top center bolts "A" and "B" must be installed with a water-proof sealant and all the bolts torqued to 40-45 ft. lbs. in the sequence shown in Illustration No. 29.

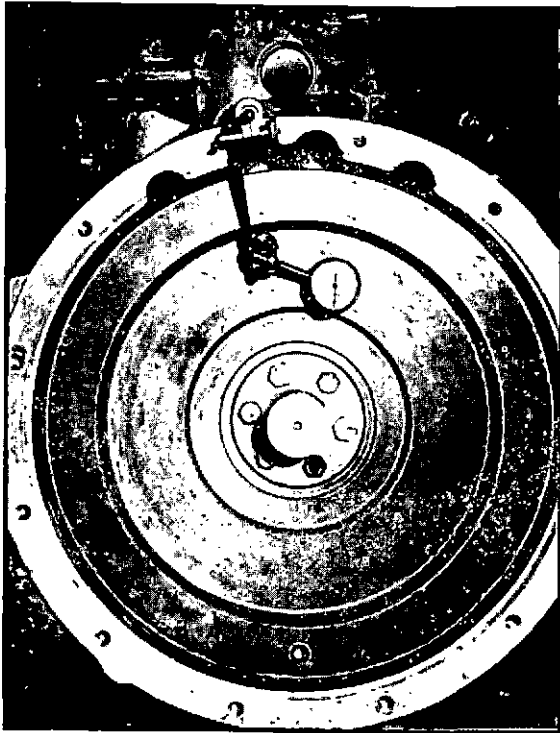

Illustration No. 27

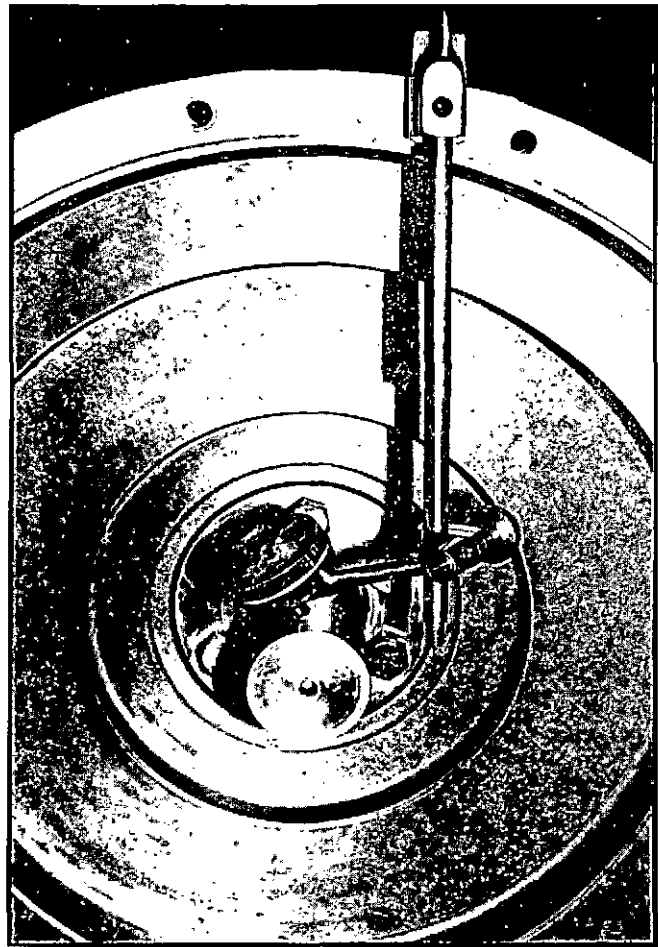

Illustration No. 28

CRANKSHAFT

The crankshaft is a machined forging, having all bearing journals surface-hardened. The nominal diameter of the main bearings is $2\frac{1}{4}$ " while the nominal diameter of the connecting rod journals is 2". The shaft has passages drilled to carry oil, under pressure, to the connecting rod bearings. These passages should be cleaned with a wire brush, see Illustration No. 30, before the shaft is installed in the engine.

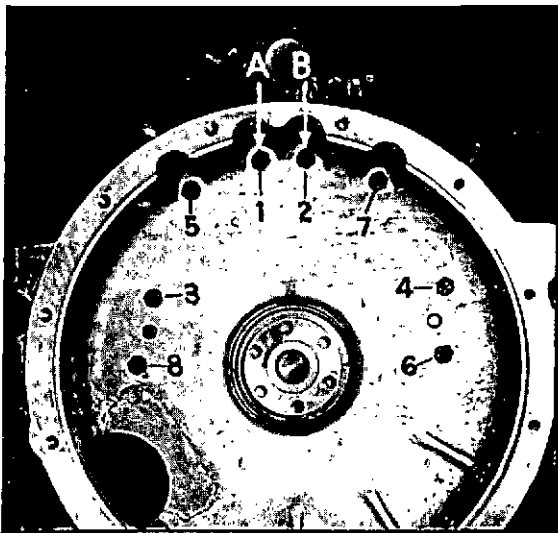

Illustration No. 29

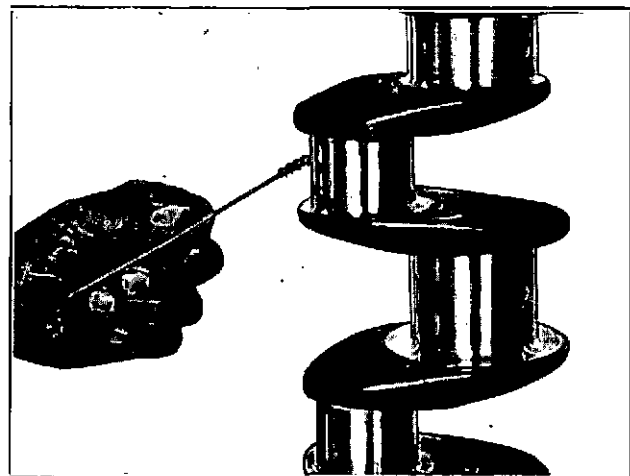

Illustration No. 30

While the diameters given above are only nominal, the following table gives the actual sizes, both standard and undersize, to which the shaft may be reground.

WARNING: When regrinding a crankshaft it is imperative that the original radius from journal to cheek be maintained. Crankshaft breakage may result from improper grinding of this fillet.

CRANKSHAFT

SIZE	MAIN	CONNECTING ROD
Standard	2.2485 / 2.2477"	1.9987 / 1.9979"
.010" U.S.	2.2385 / 2.2377"	1.9887 / 1.9879"
.020" U.S.	2.2285 / 2.2277"	1.9787 / 1.9779"

MAIN BEARINGS

The main bearings are removable, precision, shell-type and the upper shell is not interchangeable with the lower shell for each bearing. No shims are used. Reconditioning of this type bearing is accomplished by replacing the shells. These precision-type shells are completely finished before being put in place and no line reaming or scraping is required. The bearing metals commonly used in precision, shell-type bearings are harder and have a higher melting point than ordinary babbitt metal and this requires the use of a hardened crankshaft.

FITTING OF BEARINGS

All bearings are readily accessible after the oil pan and oil pump have been removed. The bearings are of ample proportion and the full-pressure lubrication system employed will give them longevity, provided they are properly installed. See "Fits and Tolerances".

Tightening of the main bearing capscrews requires some care to prevent too much strain on the parts. For this reason a torque wrench is necessary when installing the bearing caps. The torque values are given under "Fits and Tolerances". No attempt should be made to refit these bearings by filing or grinding the caps, as this will ruin the caps so new shells cannot be installed.

The rear main bearing cap and block are machined to provide for the rear oil seal and also, are machined to accommodate the four joint seals, or gasket (A) and (B), between the block and the cap, as shown in Illustration No. 31 and No. 32.

In installing and fitting these seals extreme care must be taken to insure they fit properly so no oil leaks will result. No trimming or cutting on the seals is required—just press into place.

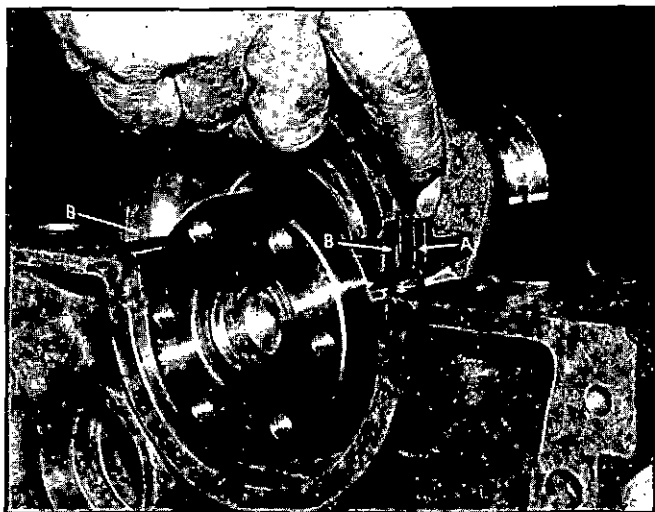

Illustration No. 31

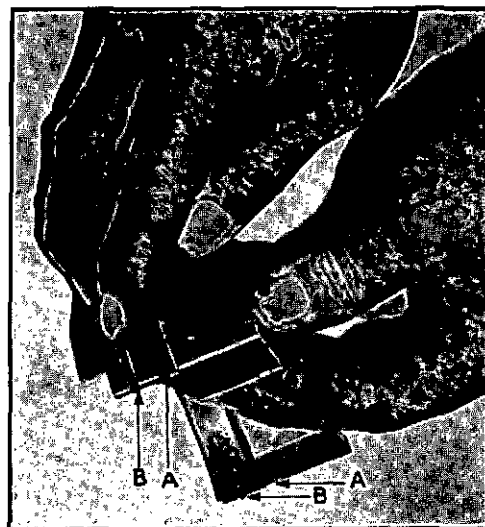

Illustration No. 32

DESCRIPTION AND MAINTENANCE

CRANKSHAFT REMOVAL

(The crankshaft is removed with the engine out of the chassis).

Remove the oil pan, oil pump and strainer assembly, starter, flywheel, bellhousing, fan belt, alternator, water pump, fan drive pulley, crankshaft pulley, alternator mounting bracket and gear cover assembly. Remove the connecting rods and pistons. See "Connecting Rods and Pistons" section.

During removal, bearings in the caps and block should be marked to insure proper reinstallation. They should not be mixed. The caps are marked with arrows pointing to the front of the engine.

Remove main bearing capscrews, caps and lower main bearing halves. **NOTE:** Mark bearings so they may be properly reinstalled in original locations. If desired, check main bearing running clearances, using Plastigage, before removing crankshaft. Next, carefully lift the crankshaft from the crankcase and remove and mark the upper main bearing halves.

Check the bearing journal taper, out-of-round and shaft misalignment. Replace bearings and recondition or replace crankshaft, as required. Examine the crankshaft gear for excessive wear or damage. If not in good condition, replace it. Also examine the balance of the gears in the gear train and replace, as required. The crankshaft gear is shrunk on the shaft and must be pressed or cut off. Examine the key and keyway. If in good condition, heat a new gear to approximately 400° F and drive it on the shaft solidly to the crankshaft shoulder. Let it cool normally—do not quench.

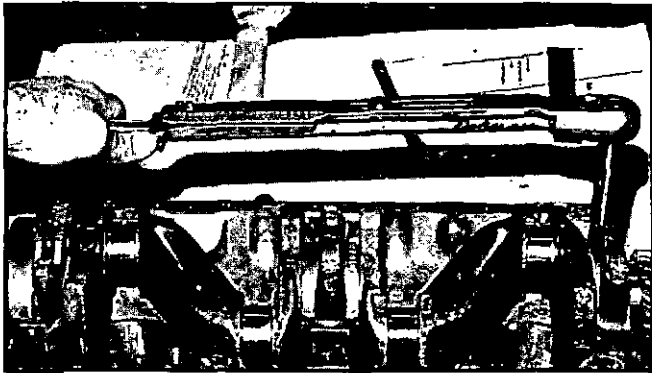

Illustration No. 33

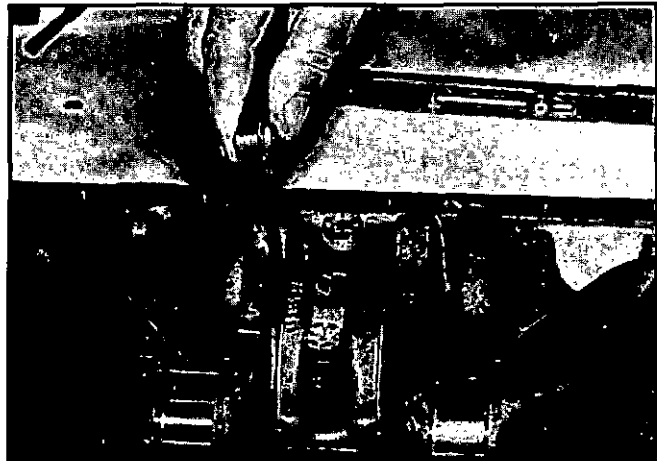

Illustration No. 34

CRANKSHAFT INSTALLATION

Locate the upper main bearing halves in the cylinder block and oil the faces lightly. Position the cam shaft gear so that, when the crankshaft is installed, the timing marks will align as in Illustration No. 38 and then lay the crankshaft in the block. Recheck to be sure the timing marks on the gears are aligned. Press new seal strips, "A" and "B", Illustration No. 31 and No. 32, completely into their respective slots in the rear main bearing cap. Do not remove any portion of these seals protruding beyond the machined edges of cap, as this excess provides a seal between the cap and crankcase.

Position lower main bearing halves in the main bearing caps and carefully position them on the crankshaft in their respective places.

Secure the capscrews and, using a torque wrench as shown in Illustration No. 33, tighten the screws to specified torque. The shaft should now turn easily in the crankcase.

Check the crankshaft end play at the center main bearing as shown in Illustration No. 34. This should be within .004" to .009" limit, free travel.

Install connecting rods and pistons. See "Connecting Rods and Pistons" section.

Lubricate the crankshaft flange and new crankshaft oil seal and, using a seal pilot-driver, correctly

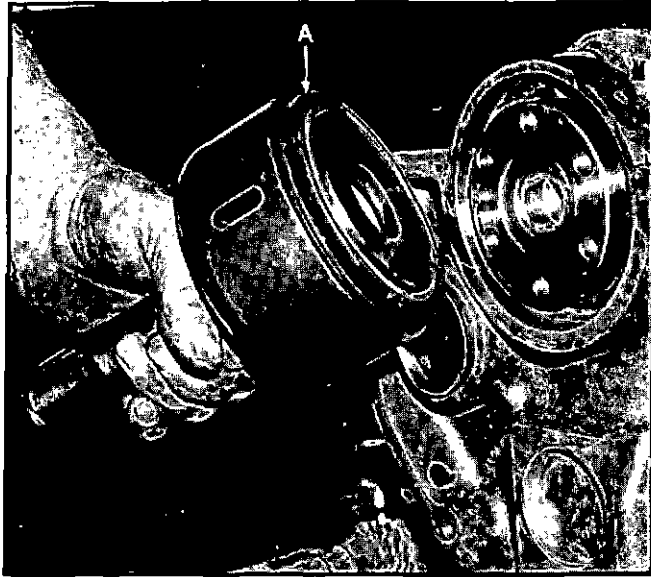

Illustration No. 35

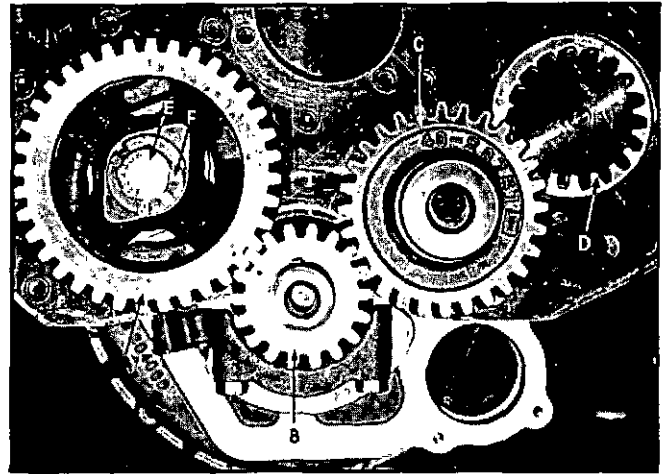

Illustration No. 36

install the seal in its position at the rear main bearing. See "A" and driver in Illustration No. 35. Install the bellhousing over the dowels and secure with screws. Install the flywheel, see "Flywheel".

Install a new front oil seal, using a seal pilot driver to properly position it in the gear cover. Install the oil pump and strainer assembly and oil pan. Install the alternator bracket, crankshaft pulley, water pump, fan drive pulley, alternator, belt and fan as removed.

CAMSHAFT, TIMING GEAR COVER AND PLATE

CAMSHAFT

The camshaft is supported on three large diameter, pressure lubricated, removable bearings in the crankcase and driven by means of a suitable gear, which meshes with the crankshaft gear. (To replace these bearings, see "Cylinder Block & Crankcase" section).

The timing of these two gears requires no check of valve position. It is only necessary to line up the punch marks on the camshaft gear, shown as "A", and the crankshaft gear as "B" in Illustration No. 36.

The camshaft end play is controlled by a thrust plate "A", Illustration No. 37, located between the front camshaft journal and the camshaft gear. Correct end play of .003" to .007" is regulated by the thickness of the thrust plate.

TO REMOVE THE CAMSHAFT

Assuming the radiator, etc., have been removed the camshaft may be removed as follows, without removing the engine from the chassis.

1. Drain the lubeoil, remove the oil pan and the oil pump and strainer assembly.
2. Disconnect and remove the distributor.
3. Remove the fan blade and belt, alternator, water pump and fan drive pulley for easier access to gear cover and gears.
4. Remove the crankshaft screw and pull the fan drive pulley. Remove the oil pan-to-gear cover attaching screws. Remove the alternator mounting bracket and front gear cover assembly.
5. Remove the valve rocker arm cover, rocker arm oil tubes, rocker arm assembly, push rods and the push rod side cover.
6. Valve tappets must be held in the "Up" position in order to remove and insert the camshaft. One method of accomplishing this is to clamp or hold the valve tappets in the "Up" position, sufficient to clear the cam lobes, with clamps or rubber bands.

DESCRIPTION AND MAINTENANCE

NOTE: To remove or assemble the camshaft to the engine, with the engine out of the chassis, the same procedure is followed except disregard operation number 6, above. With the engine out of the chassis, it is only necessary to set the engine on the bellhousing or upside down (support the engine with suitable blocks so that the cylinder head attaching screws will clear), push the tappets to the "Up" position and remove the camshaft.

7. With the tappets in the raised position, rotate the engine until the holes in the camshaft gear expose the thrust plate attaching screws, "A", in Illustration No. 38. Remove the screws and pull the camshaft carefully forward out of the cylinder block.
8. Inspect the camshaft lobes, oil pump drive gear, journals, etc., for wear or damage. Also inspect the thrust plate for clearance. If any of the parts need replacement or adjustment, disassemble the camshaft and drive gear by removing screw "E" and lock "F", Illustration No. 36, and pressing the shaft out of the gear. Suitable supports should be placed under the gear, while pressing out the shaft.

IMPORTANT: The camshaft is hollow, and actually serves as the oil header for the engine. One end is plugged with a cup plug, the other by the screw and flat washer that holds the cam gear in place. When the camshaft is removed, it is important that the plug in the rear end be removed, the internal passageway and all drilled oil holes thoroughly cleaned out with solvent and a wire brush. This should be done before the shaft is laid aside to prevent any possible residue or sludge formation from hardening.

If the camshaft bearings are worn beyond limits, they should be replaced. See the instructions in the "Cylinder Block" section and the Illustration No. 24.

To install the camshaft, reverse the above disassembly procedure, using new gaskets and seals, as required.

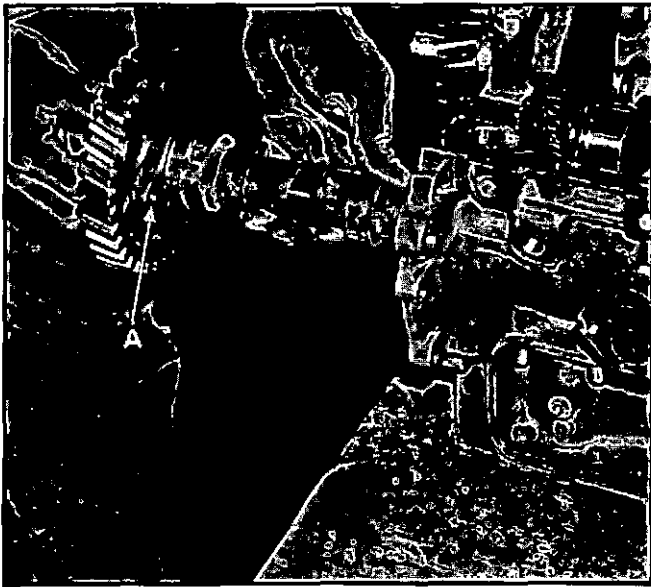

Illustration No. 37



Illustration No. 38

IDLER GEAR & SHAFT AND FRONT PLATE

The idler gear is supported in the engine by means of a shaft and bearing assembly attached to the cylinder block with a self-locking screw, as shown in Illustration No. 39. The forward end of the shaft extends through the gear cover where an O-ring is used on the shaft to seal in the lubeoil. Lubrication of the idler gear and bearing is from the throw-off and splash of oil from the other gears and bearings.

The front plate covers the front of the engine block and acts as a support for the governor, the water pump and gear cover. Assuming the gear cover, etc., are off, it is necessary to remove the camshaft gear, the water pump, the idler gear assembly and the governor before the plate can be removed. It is secured to

the block with screws and one dowel. When reassembling it to the block it should be cleaned thoroughly, a new gasket attached and placed in position on the dowel. Attaching screws should all be started and then progressively tightened to specifications. Then install the idler gear assembly, water pump, governor, etc., as removed.

GEAR COVER (Front Cover)

The gear cover contains the front crankshaft oil seal and covers the gear train. To properly install the cover clean all attaching surfaces thoroughly, press a new front oil seal in place, attach a new cover gasket and place the cover on the front plate, starting it over the dowel in the right-hand lower area. Secure with screws and washers, as removed, then install the oil pan, water pump, fan drive pulley, crankshaft pulley, fan, belt, etc., as removed.

PISTON AND CONNECTING RODS

REMOVAL

Remove valve rocker arm cover, rocker arm oil tubes, rocker arm assembly, push rods, cylinder head assembly, oil pan, oil pump and strainer assembly and distributor.

Ream ridge from top of each cylinder liner.

Remove capscrews from connecting rods. Remove bearing caps. If desired, check bearing clearances before removing pistons. Keep all rods and caps together, as well as the bearings. DO NOT MIX. Rods and caps are marked on camshaft side.

Remove piston and rod assemblies from cylinders. Note that the notch on the top of the pistons is installed towards the front of the engine. See Illustration No. 40.

Check pistons and liners for scoring. Check cylinder taper and out-of-round.

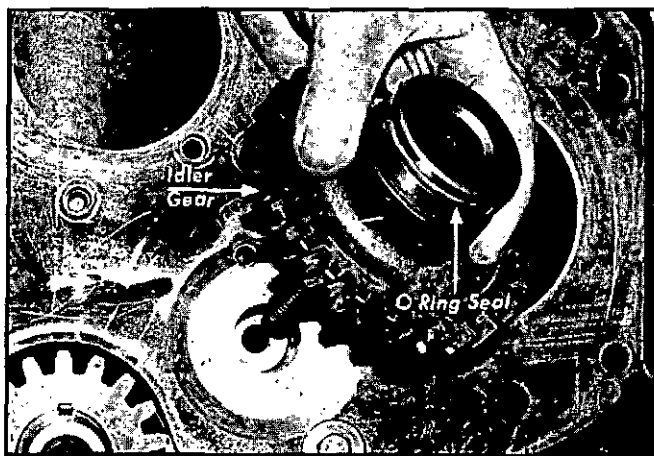

Illustration No. 39

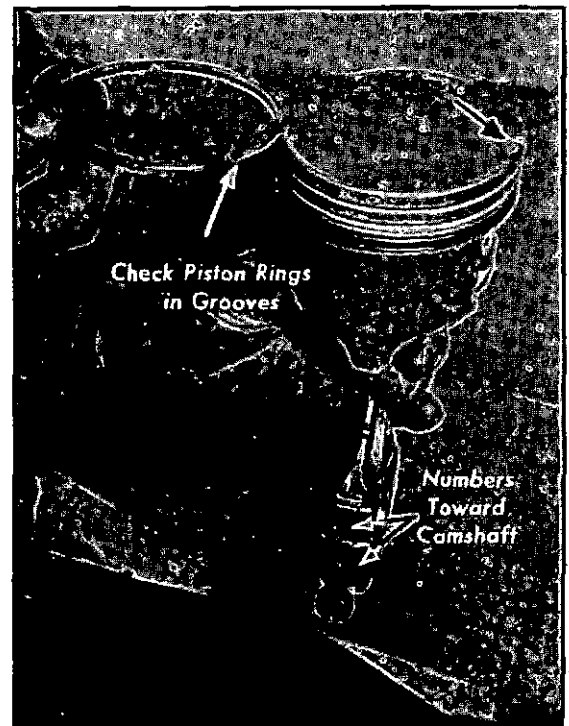

Illustration No. 40

DISASSEMBLY

Remove piston rings and clean ring grooves. Remove piston pin retainers and piston pins. Check piston pin bore diameters. Remove piston pin bushings from each connecting rod, if replacement is required. Check connecting rods for misalignment. Check the crankshaft rod journals for wear, taper or scoring. Regrind or replace the crankshaft as required and then install connecting rod bearings of proper dimensions.

DESCRIPTION AND MAINTENANCE

ASSEMBLY

Install new piston pin bushing in each connecting rod if replacement is required. Finish bushing bore to specified I.D. dimensions.

Position connecting rod and piston so that cylinder location numbers on connecting rod are on same side as notched portion or fuel inlet side of piston. Illustration No. 40. Install piston pin and retaining rings.

Deglaze the cylinder walls with hone. Check new rings for proper end gap and side clearance: If new pistons are being installed be sure to check piston clearance in bores. Install piston rings and stagger ring end gaps as stated in Illustration No. 41.

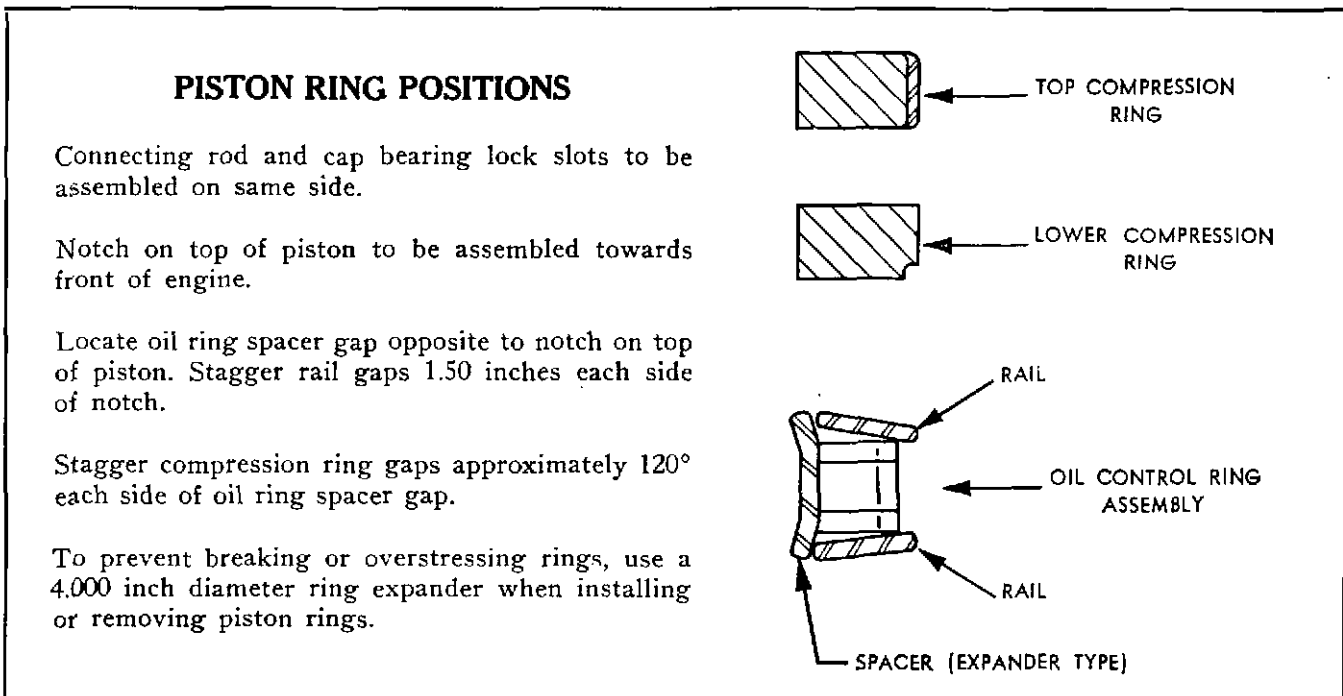

Illustration No. 41

INSTALLATION

Compress piston rings and install piston and rod assemblies in appropriate cylinders with numbers on connecting rods and caps facing camshaft side of engine. With piston in cylinder bore, install upper bearing shell and pull connecting rod and piston assembly down on crankshaft. Install bearing shell in connecting rod cap and assemble rod cap to connecting rod with capscrews. Tighten to specified torque.

Reinstall oil pump and strainer assembly, oil pan, cylinder head assembly, push rods, rocker arm assembly, rocker arm oil tubes, valve rocker arm cover and the distributor, as removed.

HANDY DATA

YOUR DISTRIBUTOR IS

.....
Name

.....
Street Address

.....
State

.....
Phone Number

ENGINE NUMBERS AND DATA

Model

Serial Number

Spec. Number

Maximum Engine Speed (Governor Setting) RPM

REPLACEMENT PART NUMBERS

For Maintenance Type Replacement Parts

Lube Oil Filter Cartridge

Belts (Fan)

Spark Plugs

Air Cleaner—Elements

Thermostat

Cylinder Head Cover Gasket

Others

.....

.....

.....

.....

.....

SERVICE AND MAINTENANCE

ENGINE TIMED AT 800 OR 1800 RPM

Set engine at 800 RPM and with a timing light, align the second timing mark that appears on the crankshaft pulley with the pointer on the gear cover.

At 1800 RPM, repeat above procedure except align the pointer with the first mark.

G-1600

FUEL	COMPR. RATIO	HERCULES DISTRIBUTOR PART NO.	FURVEYOR PART NO. DISTRIBUTOR	TIMING	RPM	SPARK PLUG GAP	NOMINAL POINT GAP	DWELL ANGLE
Gasoline	7.5:1	40-2500609	PRESTOLITE IAD-6013	6° B.T.D.C.	800	.028-.033	.020	39°-45°
LPG	7.5:1	40-2500609	PRESTOLITE IAD-6013	6° B.T.D.C.	800	.028-.033	.020	39°-45°
Nat. Gas	7.5:1	40-2500609	PRESTOLITE IAD-6013	6° B.T.D.C.	800	.028-.033	.020	39°-45°
Gasoline	7.5:1	40-2500610	PRESTOLITE IBT-4405	6° B.T.D.C. 18° B.T.D.C.	800 1800	.030 .030	.020 .020	66°-72° 66°-72°

MCD MAGNETO TIMING

The American Bosch MCD Magneto Ignition, which does not have a speed or load advance, is timed at 18° B.T.D.C. at 1800 RPM.