

---

# Operating and Maintenance Instructions

Model Series 170400, 171400, 190400, 195400

---

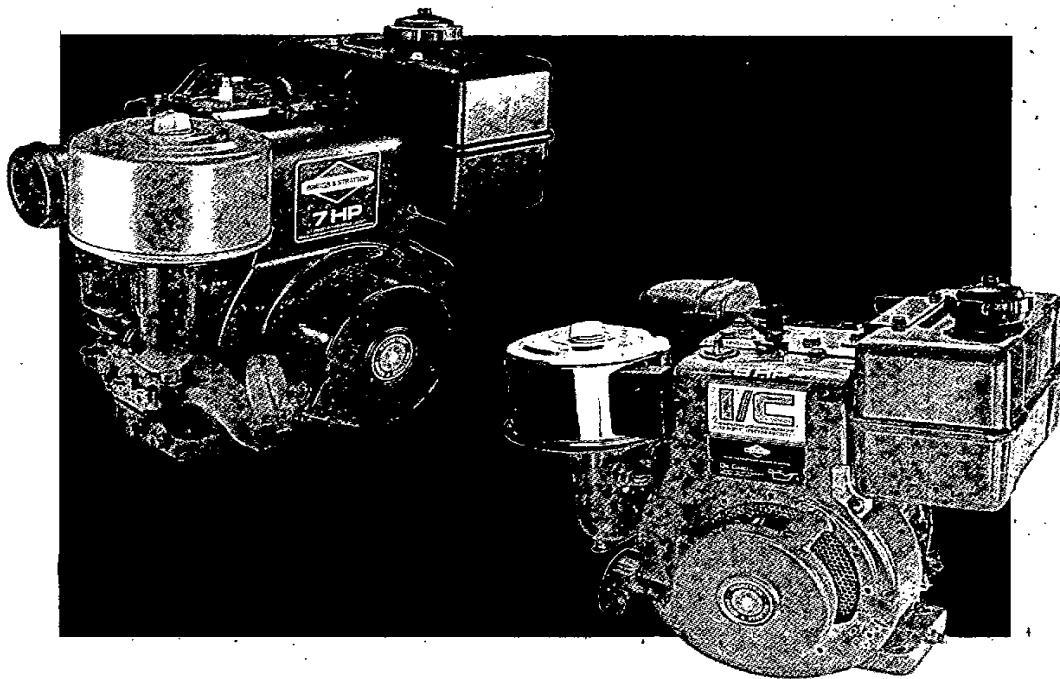

Briggs & Stratton Corporation  
Milwaukee, Wisconsin 53201

FORM NO. 270367-4/86  
PRINTED IN U.S.A.

## STARTING (Cont.)

**CAUTION:** The 120 volt electric starter is equipped with a three-prong plug for your safety. If a longer extension cord is used, it should also have three-prong and three-hole plugs.

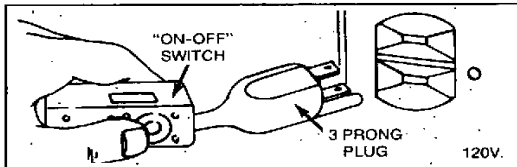

**NOTE:** If fuel drips out of carburetor while trying to start engine, the engine is over-choke. Pull starter several times or actuate starter switch with choke open.

When equipment is not in operation, provide protection from direct exposure to weather.

### COLD WEATHER STARTING HINTS

1. Be sure to use the proper oil for the temperature expected.
2. Declutch all possible external loads.
3. Set speed control at part-throttle position.
4. A slightly richer fuel mixture, obtained by turning carburetor needle valve 1/8 turn counterclockwise, will usually improve cold starting.

5. A warm battery has much more starting capacity than a cold battery.

6. Use fresh winter grade fuel.

**NOTE:** Winter grade gasoline has higher volatility to improve starting. Do not use gasoline left over from summer.

### TO STOP ENGINE

Move control to slow, then "STOP" or "OFF" position. If so equipped, turn key or switch to "STOP" or "OFF" position. Do not choke the carburetor to stop engine.

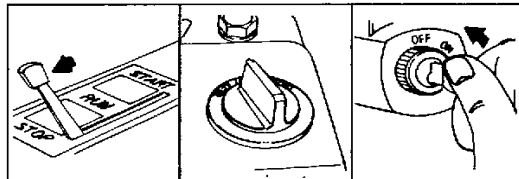

**CAUTION:** Always remove key from switch when leaving mower unattended or when mower is not in use.

**NOTE:** Close fuel shut-off valve when engine is transported to prevent fuel leakage from carburetor.

## MAINTENANCE



**CAUTION:** TO PREVENT ACCIDENTAL STARTING when servicing the engine or equipment, always remove the spark plug, or wire from the spark plug and insert in holding tab shown on page 3. Disconnect negative wire from battery terminal if equipped with 12 volt starting system.

**CHECK OIL LEVEL** regularly — after each five hours of operation. BE SURE OIL LEVEL IS MAINTAINED.

**CHANGE OIL** after first five hours of operation. Thereafter change engine oil every 50 hours of operation, under normal operating conditions. Change engine oil every 25 hours of operation if the engine is operated under heavy load, or in high ambient temperatures.

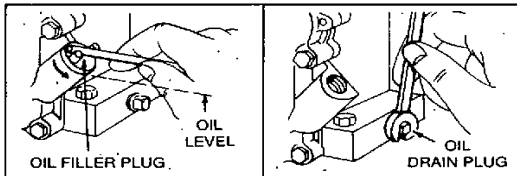

Remove oil drain plug and drain oil while engine is warm. Replace drain plug. Remove oil fill plug, oil-minder, or cap and dipstick and refill with new oil of proper grade. Replace oil fill plug, oil-minder or cap and dipstick.

**CHANGE OIL (GEAR REDUCTION optional).** Remove oil level plug and oil fill plug. Drain oil every 100 hours of operation. To refill, pour 10W-30 oil into filler hole until it runs out level check hole. Replace both plugs. Oil fill plug has a vent hole and must be installed on top of gear case cover.

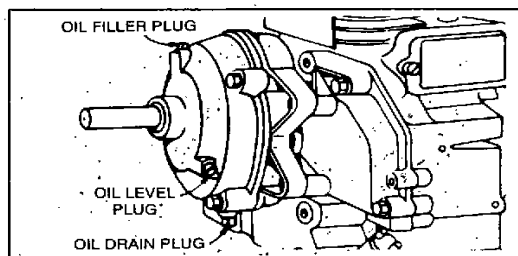

## BEFORE STARTING

### READ THE OPERATING INSTRUCTIONS OF THE EQUIPMENT THIS ENGINE POWERS

#### OIL RECOMMENDATIONS

**Note:** Engine is shipped **WITHOUT** oil.

Use a high quality detergent oil classified "For Service SF, SE, SD or SC." Detergent oils keep the engine cleaner and retard the formation of gum and varnish deposits. No special additives should be used with recommended oils.

#### RECOMMENDED SAE VISCOSITY GRADES

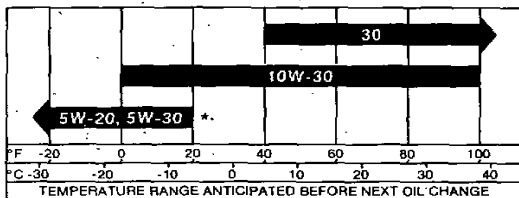

\* If not available, a synthetic oil may be used having 5W-20, 5W-30 or 5W-40 viscosity.

**NOTE:** 10W-40 oil may be used if 10W-30 is not available.

#### TO FILL CRANKCASE WITH OIL

Place engine level. Clean area around oil fill before removing oil fill plug or oil-minder.

**OIL FILL PLUG.** Remove oil fill plug or (optional) oil-minder. Fill crankcase to point of overflowing. **POUR SLOWLY.** Capacity approximately 2-3/4 pints (1.3 liters). Replace oil fill plug or oil-minder.

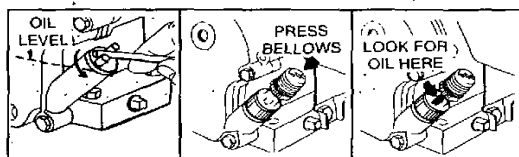

**EXTENDED OIL FILL (Optional).** Remove cap and dipstick. **FILL TO FULL MARK** on dipstick, **POUR SLOWLY.** Capacity approximately 2-3/4 pints (1.3 liters). When checking oil level, push or screw dipstick assembly firmly but slowly until cap bottoms on tube. **DO NOT OVERFILL.** Dipstick assembly must be securely assembled into tube at all times when engine is operating.

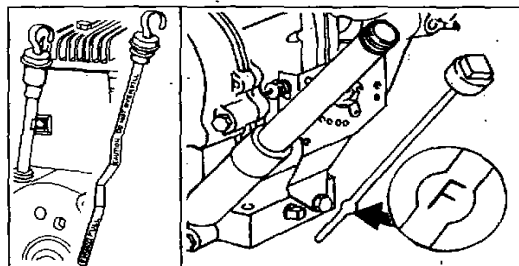

#### CHARGE BATTERY

Charge battery before use on engines equipped with (OPTIONAL) 12 volt electric starter motor. See equipment manufacturers' recommendations.

FORM NO. 270367-4/86  
PRINTED IN U.S.A.

#### FUEL RECOMMENDATIONS

Our engines will operate satisfactorily on any gasoline intended for automotive use. **DO NOT MIX OIL WITH GASOLINE.**

We recommend the use of clean, fresh, **lead-free** gasoline. Leaded gasoline may be used if lead-free is not available. A minimum of 77 octane is recommended. The use of lead-free gasoline results in fewer combustion deposits and longer valve life.

**NOTE:** We **DO NOT** recommend the use of gasoline which contains alcohol, such as gasohol. However, if gasoline with alcohol is used, it **MUST NOT** contain more than 10 percent Ethanol and **MUST** be removed from the engine during storage. **DO NOT** use gasoline containing Methanol. See **STORAGE INSTRUCTIONS.**

**DO NOT** fill fuel tank to point of overflowing. Allow approximately 1/4" of tank space for fuel expansion.

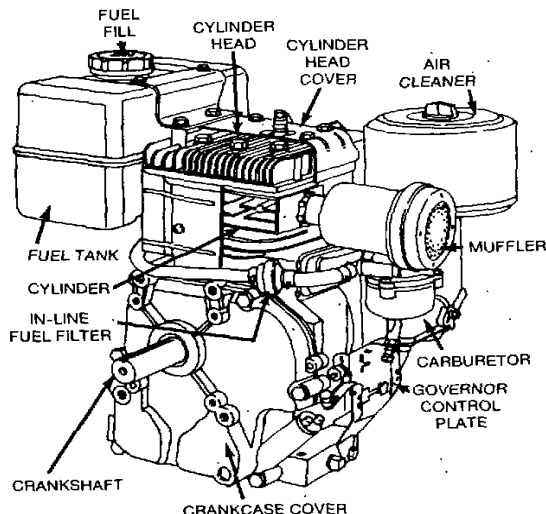
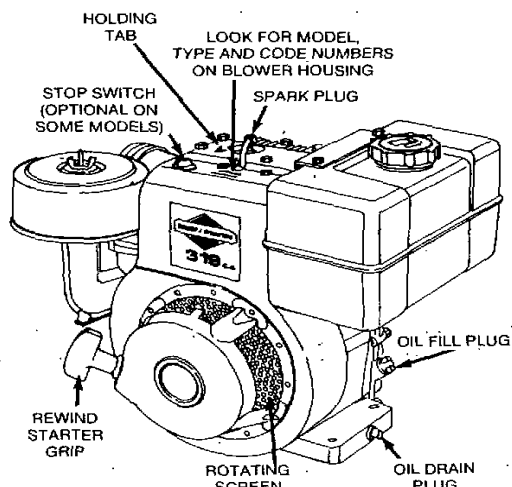



## IN THE INTEREST OF SAFETY



**WARNING:** DO NOT RUN THE ENGINE IN AN ENCLOSED AREA. Exhaust gases contain carbon monoxide, an odorless and deadly poison.

A FIRE OR EXPLOSION CAN OCCUR RESULTING IN PERSONAL INJURY IF THE FOLLOWING INSTRUCTIONS ARE NOT FOLLOWED:

1. DO NOT FILL GASOLINE TANK while engine is running. Allow engine to cool for two minutes before refueling.
2. Do not operate the engine when an odor of gasoline is present or other explosive conditions exist.
3. If gasoline is spilled, move machine away from the area of the spill and avoid creating any source of ignition until the gasoline has evaporated.
4. DO NOT STORE, SPILL OR USE GASOLINE NEAR AN OPEN FLAME, or devices such as a stove, furnace, water heater which utilize a pilot light, or devices which can create a spark.
5. Refuel outdoors preferably, or only in well ventilated areas.
6. DO NOT OPERATE ENGINE WITHOUT A MUFFLER. Inspect muffler periodically and replace, if necessary.
7. Periodically clean the muffler area to prevent grass, dirt and combustible material from accumulating.
8. DO NOT use this engine on any forest covered, brush covered or grass covered unimproved land unless a spark arrester is attached to the muffler.
9. DO NOT operate the engine if air cleaner or cover directly over the carburetor air intake is removed.
10. DO NOT choke carburetor to stop the engine.

**CAUTION:** DO NOT RUN ENGINE AT EXCESSIVE SPEEDS. Operating an engine at excessive speeds increases the danger of personal injury.

1. DO NOT TAMPER WITH GOVERNOR SPRINGS, GOVERNOR LINKS OR OTHER PARTS WHICH MAY INCREASE THE GOVERNED ENGINE SPEED.

2. A.N.S.I. Standard Safety Specifications for rotary power lawn mowers specify a maximum blade tip speed of 19,000 feet per minute (96.5 meters per second), primarily to reduce the danger from thrown objects.
3. Do not tamper with the engine speed selected by the original equipment manufacturer.
4. DO NOT TOUCH hot mufflers, cylinders or fins as contact may cause burns.
5. Dirt and grass clippings or other debris, in cooling fins or governor parts can affect engine speed. See cleaning instructions in MAINTENANCE section.
6. TO PREVENT HAND OR ARM INJURY, always pull starter cord rapidly to avoid kickback; starting engine with a loose blade or without a blade may cause a severe kickback.
7. ALWAYS KEEP HANDS AND FEET CLEAR OF MOVING OR ROTATING PARTS.
8. TO PREVENT ACCIDENTAL STARTING when servicing the engine or equipment, always remove the spark plug or wire from the spark plug and insert in holding tab shown on page 3. Disconnect negative wire from battery terminal, if equipped with a 12 volt starting system.

### WHEN WORKING ON EQUIPMENT

DO NOT STRIKE FLYWHEEL with a hard object or metal tool as this may cause flywheel to shatter in operation, causing personal injury or property damage. To remove flywheel, use Briggs & Stratton approved tools only.

### IN THE INTEREST OF ENVIRONMENT

A muffler which leaks because of rust or damage can permit an increased exhaust noise level. Therefore, examine the muffler periodically to be sure it is functioning effectively. To purchase a new muffler, see SERVICE AND REPAIR INFORMATION.

**CAUTION:** If this engine is not equipped with a spark arrester and is to be used on any forest covered, brush covered, or grass covered unimproved land, before using on such land a spark arrester must be added to the muffler. The arrester must be maintained in effective working order by the operator. In the State of California the above is required by law (Section 4442 of the California Public Resources Code). Other states may have similar laws. Federal laws apply on federal lands. See your Authorized Briggs & Stratton Service Center for spark arrester muffler options.



THIS SYMBOL MEANS **WARNING** or **CAUTION**. PERSONAL INJURY AND/OR PROPERTY DAMAGE MAY OCCUR UNLESS INSTRUCTIONS ARE FOLLOWED CAREFULLY.

# SERVICE & REPAIR INFORMATION

If service or repair is needed, contact an Authorized Briggs & Stratton Service Center. To serve you promptly and efficiently, the Service Center will need the model, type and code number on your engine.

Each Authorized Service Center carries a stock of original Briggs & Stratton repair parts and is equipped with special service tools. Trained mechanics assure expert repair service on all Briggs & Stratton engines.

Major engine repairs should not be attempted unless you have the proper tools and a thorough knowledge of internal combustion engine repair procedure.



Your nearest service center is listed in the "Yellow Pages" under "Engines, Gasoline" or "Gasoline Engines". He is one of over 25,000 authorized dealers available to serve you.

This illustrated book includes "Theories of Operation", common specifications and detailed information covering the adjustment, tune-up and repair procedures for 2 through 16 H.P. single cylinder, 4 cycle models. It is available from any Authorized Briggs & Stratton Service Center. Order as Part Number 270962.



# GENERAL INFORMATION

This engine is a single-cylinder L-head, air-cooled type.

### MODEL SERIES 170400 and 171400

Bore..... 3" (76.20 mm)  
 Stroke..... 2-3/8" (60.33 mm)  
 Displacement..... 16.79 cu. in. (275.1 cc)  
 Horsepower Max..... 7.0 @ 3600 RPM  
 Torque (Ft. Lbs.) Max..... 11.0 @ 2600 RPM

### MODEL SERIES 190400 and 195400

Bore..... 3" (76.20 mm)  
 Stroke..... 2-3/4" (69.85 mm)  
 Displacement..... 19.44 cu. in. (318.5 cc)  
 Horsepower Max..... 8.0 @ 3600 RPM  
 Torque (Ft. Lbs.) Max..... 12.7 @ 2500 RPM

The horsepower ratings listed are established in accordance with the Society of Automotive Engineers Test Code-J607. For practical operation, the horsepower loading should not exceed 85% of these ratings. Engine power will decrease 3-1/2% for each 1,000 feet (304.8 m) above sea level and 1% for each 10° above 60° F (16° C).

In some areas, local law requires the use of a resistor spark plug so as to suppress ignition signals. If an engine was originally equipped with a resistor spark plug, be sure to use the same type of spark plug for replacement.

### TUNE-UP SPECIFICATIONS

Spark Plug Type	Champion	Autolite
Short Plug	CJ-8	235
Long Plug	J-8	295
Resistor Short Plug	RCJ-8	245
Resistor Long Plug	RJ-8	306

Spark Plug Gap..... .030" (.76 mm)  
 Intake Valve Clearance..... .005"-.007" (.13-.18 mm)  
 Exhaust Valve Clearance..... .009"-.011" (.23-.28 mm)



**WARNING:** For electrical safety, always remove cable from negative (-) side of the battery before attempting any repairs or maintenance.

### STORAGE INSTRUCTIONS

Engines to be stored over 30 days should be completely drained of fuel to prevent gum deposits forming on essential carburetor parts, fuel filter and tank.

NOTE: The use of a fuel additive, such as STA-BIL®, or an equivalent, will minimize the formation of fuel gum deposits during storage. Such an additive may be added to the gasoline in the fuel tank of the engine, or to the gasoline in a storage container.

- All fuel should be removed from the tank. Run the engine until it stops from lack of fuel.
- While engine is still warm, drain oil from crankcase. Refill with fresh oil.
- Remove spark plug, pour approximately 1/2 ounce (15 cc) of engine oil into cylinder and crank slowly to distribute oil. Replace spark plug.
- Clean dirt and chaff from cylinder, cylinder head fins, blower housing, rotating screen and muffler areas.
- Store in a clean and dry area.

### TYPICAL WIRING DIAGRAMS

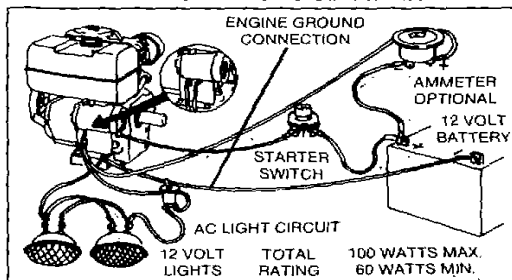

BRIGGS & STRATTON ENGINES ARE MADE UNDER ONE OR MORE OF THE FOLLOWING PATENTS:

2,899,491	3,305,223	3,526,146	3,625,492	3,746,393	3,971,353	4,233,043
3,194,224	3,457,804	3,572,218	3,650,354	3,961,724	4,168,288	4,270,509
3,276,439	3,465,740	3,625,071	3,738,345	3,968,854	4,189,040	

DESIGN  
 D-247,177  
 OTHER PATENTS PENDING

## STARTING

Start, store and fuel engine in a level position.

DO NOT use a pressurized starting fluid as severe internal engine damage may occur due to loss of lubrication.

**OPEN FUEL VALVE** — on engines so equipped.

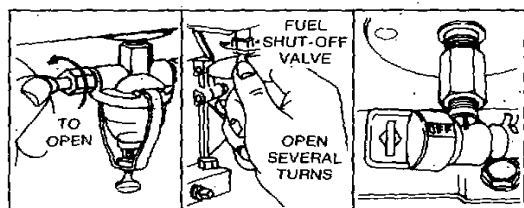

### CHOKE ENGINE:

Engine may be equipped with either manual, remote or choke-a-matic controls.

**MANUAL CHOKE:** Move lever as illustrated.



**CHOKE-A-MATIC CONTROLS:** Move controls as far as possible toward "CHOKE" or "START".

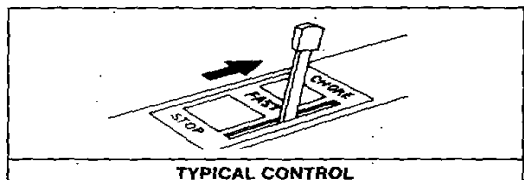

**STOP SWITCH:** Move STOP switch away from spark plug or to "ON" position as illustrated, if so equipped.

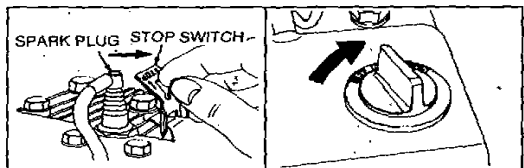

**NOTE:** A warm engine requires less choking than a cold engine.

**NOTE:** Engine may not start if controls on powered equipment do not close choke fully. See ADJUSTMENT section.

**SPEED CONTROL LEVER:** Move speed control lever to "RUN," "FAST" or "START" position if so equipped.

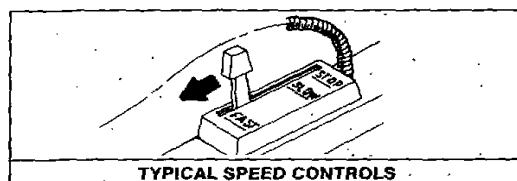

### TO START ENGINE

**WARNING:** ALWAYS KEEP HANDS AND FEET CLEAR OF MOWER BLADE OR OTHER ROTATING MACHINERY.

**Rewind Starter.** Grasp starter grip as illustrated and pull slowly until starter engages. Then pull cord rapidly to overcome compression, prevent kickback and start engine. Repeat if necessary with choke opened slightly. When engine starts, open choke gradually.

**Rope Starter.** Wind the starter rope around the pulley in direction shown by arrow. Pull the rope with a quick full arm stroke to overcome compression and prevent kickback. Repeat if necessary with choke opened slightly. When engine starts, open choke gradually.

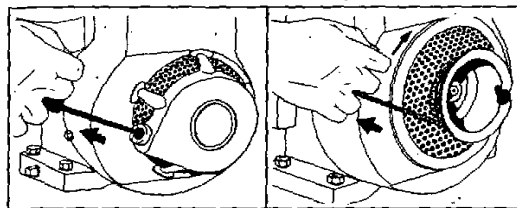

**CAUTION:** When using rope starter to crank engine, use caution so knotted end of rope does not strike persons standing nearby.

**Electric Starter.** Turn key to "START" position and/or press starter button on powered equipment. The best starter life is provided by using short starting cycles of several seconds. Prolonged cranking can damage the starter motor if cranked more than 15 seconds per minute. When engine starts, open choke gradually.

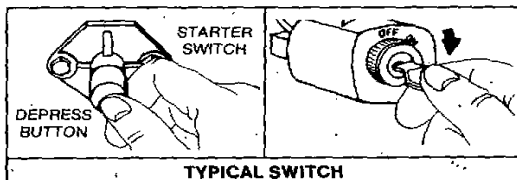

# MAINTENANCE (Cont.)

## TO SERVICE AIR CLEANERS

### CARTRIDGE AIR CLEANER

Remove and clean cartridge yearly or after every 25 hours, whichever occurs first. Service more often if necessary. Clean by tapping gently on flat surface. If very dirty, replace cartridge, or wash in a low or non-sudsing detergent and warm water solution. Rinse thoroughly with flowing water from inside out until water is clear. Cartridge must be allowed to stand and air dry thoroughly before using.

**CAUTION:** Petroleum solvents, such as kerosene, are not to be used to clean cartridge. They may cause deterioration of the cartridge. **DO NOT OIL CARTRIDGE. DO NOT USE PRESSURIZED AIR TO CLEAN OR DRY CARTRIDGE.**

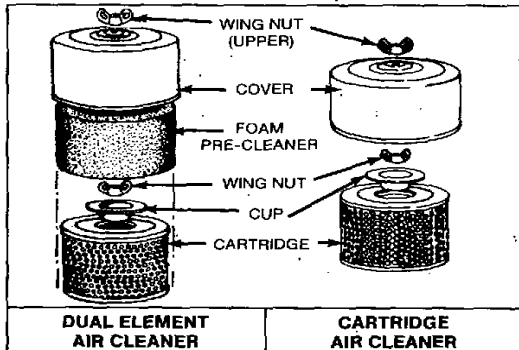

### DUAL ELEMENT AIR CLEANER (OPTIONAL ON SOME MODELS)

Clean and re-oil foam pre-cleaner at three month intervals or every 25 hours, whichever occurs first.

**NOTE:** Service more often under dusty conditions.

1. Remove knob and cover.
2. Remove foam pre-cleaner by sliding it off the paper cartridge.
3. a. Wash foam pre-cleaner in kerosene or liquid detergent and water.  
b. Wrap foam pre-cleaner in cloth and squeeze dry.  
c. Saturate foam pre-cleaner in engine oil. Squeeze to remove excess oil.
4. Install foam pre-cleaner over paper cartridge. Re-assemble cover and screw down tight.

**NOTE:** Replace or clean cartridge included with DUAL ELEMENT AIR CLEANER yearly or every 100 hours as described in CARTRIDGE AIR CLEANER. Service more often if necessary.

### TO SERVICE AIR CLEANER "OIL FOAM" AIR CLEANER

Clean and re-oil foam element or foam pre-cleaner at three month intervals or every 25 hours, whichever occurs first.

**NOTE:** Service more often under dusty conditions.

1. Remove wing nut and cover.
2. Remove air cleaner carefully to prevent dirt from entering carburetor.
3. Take air cleaner apart and clean.
  - a. WASH foam element in kerosene or liquid detergent and water to remove dirt.
  - b. Wrap foam in cloth and squeeze dry.
  - c. Saturate foam with engine oil. Squeeze to remove excess oil.
4. Reassemble parts and fasten to carburetor.

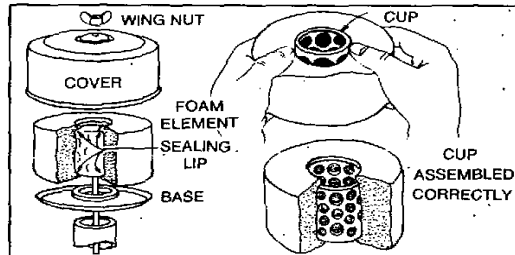

**REMOVE COMBUSTION DEPOSITS** every 100-300 hours of operation. Remove cylinder head and cylinder head shield. Scrape and wire brush the combustion deposits from cylinder, cylinder head, top of piston and around valves. Use a soft brush to remove deposits.

Re-assemble gasket, cylinder head and cylinder head shield. Turn screws down finger tight, with the three longer screws around the exhaust valve, if so equipped. Torque cylinder head screws in a staggered sequence to 140 inch pounds (15.82 Nm).

**CLEAN ENGINE** — Remove dirt and debris with a cloth or brush. Cleaning with a forceful spray of water is not recommended as water could contaminate the fuel system.

**CLEAN COOLING SYSTEM** — Grass, chaff or dirt may clog the rotating screen and the air cooling system, especially after prolonged service cutting dry grass. Yearly or every 100 hours, whichever occurs first, remove the blower housing and clean the areas shown to avoid overspeeding, overheating and engine damage. Clean more often if necessary.

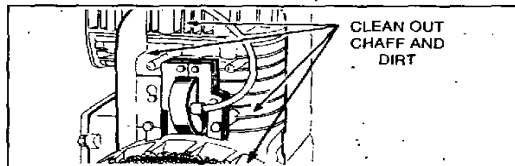

**WARNING:** Periodically clean muffler area to remove all grass, dirt and combustible debris.

**SPARK ARRESTER EQUIPPED MUFFLER** — If engine muffler is equipped with spark arrester screen assembly, remove every 50 hours for cleaning and inspection. Replace if damaged.

## MAINTENANCE (Cont.)

**SPARK PLUG** — Clean and reset gap at .030" every 100 hours of operation.

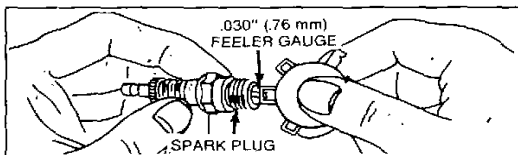

**NOTE:** Do not blast clean spark plug. Spark plug should be cleaned by scraping or wire brushing and washing with a commercial solvent.

**CAUTION:** Sparking can occur if wire terminal does not fit firmly on spark plug, or if stop switch vibrates against spark plug. Reform terminal or repair switch if necessary.

**FUEL FILTER** — Replace IN-LINE filter or clean screen and bowl every season.

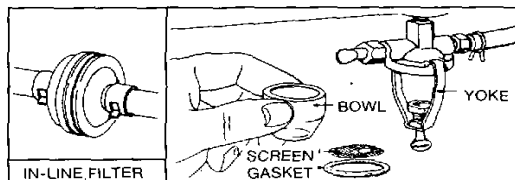

## ADJUSTMENTS

### CARBURETOR ADJUSTMENTS

Minor carburetor adjustment may be required to compensate for differences in fuel, temperature, altitude or load.

**NOTE:** The air cleaner must be assembled to carburetor when running engine.

**TO ADJUST CARBURETOR** — Gently turn valves clockwise until they just close. Valves may be damaged by turning them too far.

Now open needle valve 1-1/2 turns counterclockwise and idle valve one turn. This initial adjustment will permit the engine to be started and warmed up prior to final adjustment.

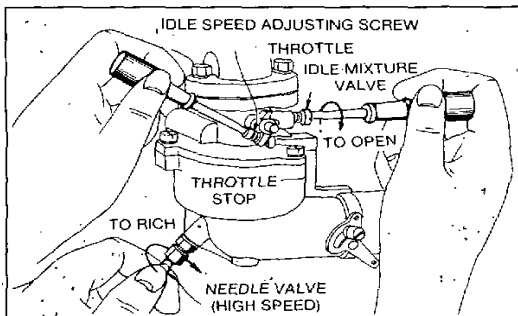

### FINAL ADJUSTMENT

Place speed control lever in "FAST" position. Turn needle valve in until engine slows (clockwise - lean mixture). Then turn it out past smooth operating point (rich mixture). Now turn needle valve to midpoint between rich and lean. Next, adjust idle RPM. Rotate throttle counterclockwise and hold against stop while adjusting idle speed adjusting screw to obtain 1750 RPM. Holding throttle against idle stop, turn idle valve in (lean) and out (rich). Set at midpoint between rich and lean. Recheck idle RPM. Release throttle. If engine

will not accelerate properly, the carburetor should be re-adjusted, usually to a slightly richer mixture.

### CONTROL ADJUSTMENTS

Proper choke and stop switch operation is dependent upon proper adjustment of controls on the powered equipment.

### TO ADJUST CHOKE-A-MATIC CONTROLS:

Place lever on equipment in "CHOKE" (high speed) position. Loosen casing clamp screw "B." Move casing "A" and wire until lever "D" touches choke operating link at "C." Tighten casing clamp screw "B." Move lever to "STOP" position. Lever must make good contact with stop switch if so equipped.

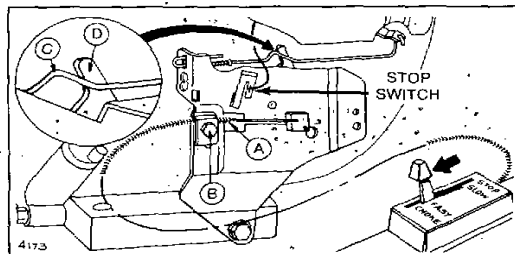

### SPEED CONTROL ADJUSTMENT

The acceptable operating speed range is 1800 to 3600 RPM. Idle speed is 1750 RPM. The manufacturer of the equipment on which the engine is used, specifies the top governed no load speed at which the engine may be operated. **DO NOT EXCEED** this speed.

