

**GO-G SERIES  
3-4-6 CYLINDER  
GASOLINE ENGINES**

**OPERATION  
AND  
MAINTENANCE  
MANUAL  
FOR**

**GO-G SERIES  
THREE-FOUR-SIX CYLINDER  
GASOLINE ENGINES**

**JULY 1961**



**HERCULES**

**HERCULES MOTORS CORPORATION**  
Canton, Ohio, U.S.A.

20502-2

# OPERATION AND MAINTENANCE MANUAL FOR GO-G SERIES

GO Three Cylinder Serial Numbers ..... 3750001 - 3800000  
 GO Four Cylinder Serial Numbers ..... 3100001 - 3200000  
 GO-G Six Cylinder Serial Numbers ..... 3300001 - 3400000

<u>MODEL</u>	<u>NO. CYLS.</u>	<u>BORE AND STROKE</u>	<u>CHARACTERISTICS</u>
GO-149	3	3 $\frac{3}{4}$ " x 4 $\frac{1}{2}$ " ...	Standard Crankshaft
GO-169	3	4" x 4 $\frac{1}{2}$ " ...	Standard Crankshaft
GO-149H	3	3 $\frac{3}{4}$ " x 4 $\frac{1}{2}$ " ...	Heavy Duty Crankshaft
GO-169H	3	4" x 4 $\frac{1}{2}$ " ...	Heavy Duty Crankshaft
GO-198	4	3 $\frac{3}{4}$ " x 4 $\frac{1}{2}$ " ...	Side Spark Plug - Standard Crankshaft
GO-226	4	4" x 4 $\frac{1}{2}$ " ...	Side Spark Plug - Standard Crankshaft
GO-198A	4	3 $\frac{3}{4}$ " x 4 $\frac{1}{2}$ " ...	Center Spark Plug - Standard Crankshaft
GO-226A	4	4" x 4 $\frac{1}{2}$ " ...	Center Spark Plug - Standard Crankshaft
GO-198AH	4	3 $\frac{3}{4}$ " x 4 $\frac{1}{2}$ " ...	Center Spark Plug - Heavy Duty Crankshaft
GO-226AH	4	4" x 4 $\frac{1}{2}$ " ...	Center Spark Plug - Heavy Duty Crankshaft
GO-298	6	3 $\frac{3}{4}$ " x 4 $\frac{1}{2}$ " ...	Side Spark Plug - Standard Crankshaft
GO-339	6	4" x 4 $\frac{1}{2}$ " ...	Side Spark Plug - Standard Crankshaft
G-298	6	3 $\frac{3}{4}$ " x 4 $\frac{1}{2}$ " ...	Center Spark Plug - Standard Crankshaft
G-339	6	4" x 4 $\frac{1}{2}$ " ...	Center Spark Plug - Standard Crankshaft
G-298H	6	3 $\frac{3}{4}$ " x 4 $\frac{1}{2}$ " ...	Center Spark Plug - Heavy Duty Crankshaft
G-339H	6	4" x 4 $\frac{1}{2}$ " ...	Center Spark Plug - Heavy Duty Crankshaft

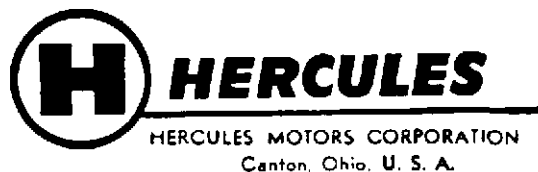

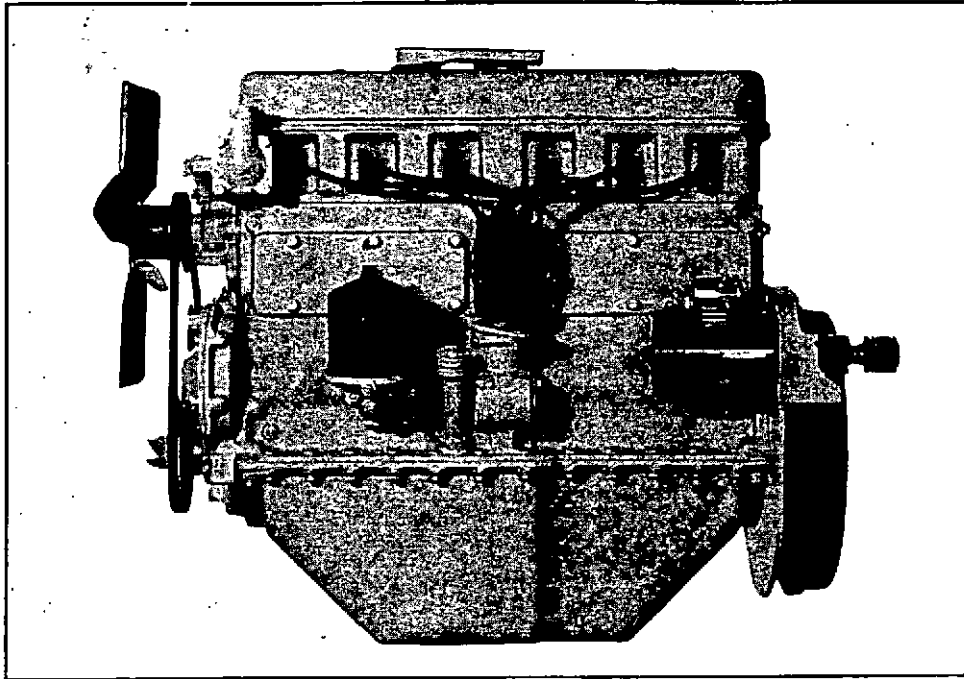

GO 6 Cylinder Series - Spark Plug and Distributor Side

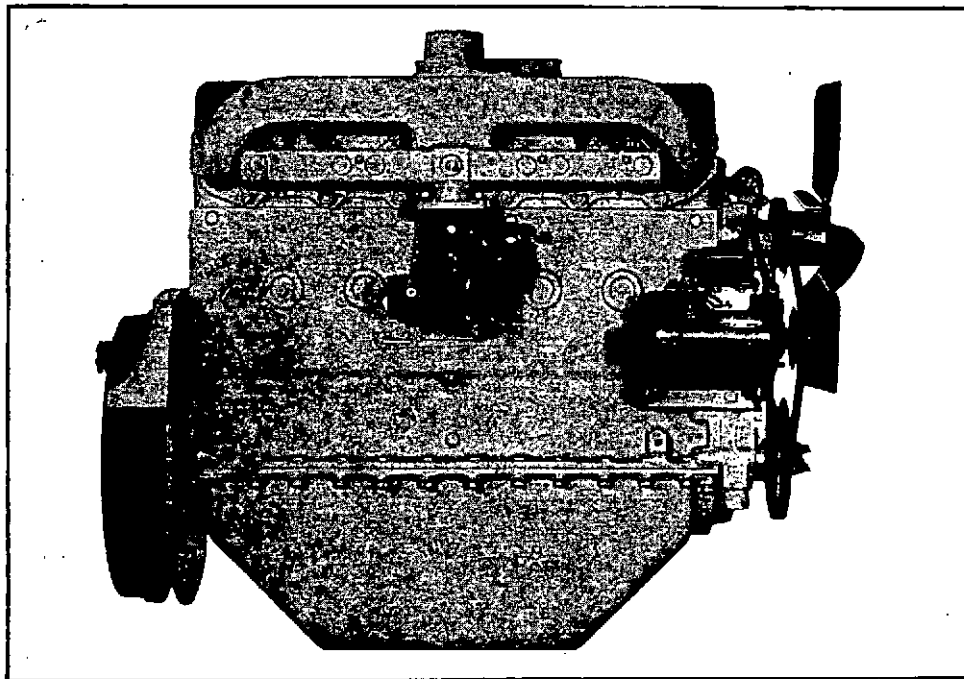

GO 6 Cylinder Series - Manifold Side

# Section and Group Index

	Page		Page
Clearance Table .....	62	Engine Trouble Shooting—Continued	
Description and Maintenance .....	15 to 50	Electrical System .....	55 to 58
Air Cleaner .....	15, 16	Engine Knocking .....	52
Bayonet Gauge .....	16	Engine Misses Intermittently .....	51
Bearings, Main .....	34	Excessive Oil Consumption .....	59
Bearings, Connecting Rod .....	21, 22, 23	Excessive Smoke from Exhaust .....	58
Bellhousing or Flywheel .....	16, 17	Explosion in Carburetor or Air Cleaner .....	61
Breather .....	16	Explosion in Muffler .....	61
Camshaft .....	17, 18, 19	Fuel System .....	53, 54
Carburetor .....	19, 20, 21	Loss of Power .....	51, 52
Connecting Rod .....	21, 22, 23	Low Oil Pressure .....	60
Cooling System .....	23, 24	Rapid Cylinder or Piston Wear .....	60
Crankshaft .....	24, 25	Spark Knock or Ping .....	61
Cylinder and Crankcase .....	25	Valves Sticking .....	60
Cylinder Head .....	25, 26	General Description and Features of Design .....	7, 8
Cylinder Sleeves .....	26	Camshaft .....	8
Fan Assembly .....	27	Connecting Rods and Pistons .....	8
Flywheel .....	27, 28	Cylinder Block and Crankcase .....	7
Flywheel Housing .....	16, 17	Cylinder Head .....	7
Fuel Pump .....	28, 29	Main Bearings .....	7
Gear Cover .....	29, 30, 31	Oiling System .....	8
Generator .....	31, 32	Piston .....	8
Governor .....	32	Valves .....	8
Ignition Timing .....	33, 34	Introduction .....	5
Main Bearings .....	34, 35	Lubrication .....	13, 14
Manifold .....	35, 36	Oil Changing .....	13
Oil Filter .....	36	Description of Lubricating System .....	13
Oil Pan .....	36, 37	Lubrication Instructions .....	13
Oil Pressure Adjustment .....	37	Oil Level .....	13
Oil Pump .....	38, 39	Viscosity Grades .....	14
Oil Seal .....	39, 40	Use Good Oil .....	13
Piston .....	40	Maintenance—See Description	
Piston Pin .....	41	and Maintenance .....	15 to 50
Piston Rings .....	41	Operation .....	9 to 12
Spark Plugs .....	42, 43	Cold Weather Starting .....	12
Starting Motor .....	44	Cold Weather Starting Suggestions .....	12
Thermostat and Bypass .....	45	Operating Instructions After Starting .....	11, 12
Valve Grinding .....	46, 47, 48	Precautions .....	9, 10
Valves .....	45, 46	Starting and Operating Suggestions .....	10
Valve Tappets .....	48	Starting the Engine .....	10, 11
Water Pump and Fan Assembly .....	49	Stopping the Engine .....	10
Wiring Diagram .....	50	Specifications .....	6
Engine Storage .....	13	Tools .....	63
Engine Trouble Shooting .....	51 to 61	Warranty .....	4
Bearing Failures .....	59, 60	Torque Wrench Tension .....	62
Burned Valves or Valve Seats .....	60, 61		
Clutch Assembly .....	55		
Cooling System .....	54, 55		

# Introduction

The Hercules GO - G series of gasoline engines are available in three cylinder, four cylinder and six cylinder models, and are of the overhead valve, four cycle, heavy-duty commercial type engines. The design is the result of years of development and field experience. Extensive tests have proven that these engines are adaptable to purposes for which such sizes and types are required.

All locations given as right-hand (R.H.) or left-hand (L.H.) have reference to the observer's position when facing the flywheel or clutch. The cylinder block is reversible; therefore, the camshaft and distributor may be on either the right-hand or left-hand side, depending upon the application. The front of the engine is the timing gear end, irregardless of the cylinder block position. The flywheel and clutch end is the rear end of the engine. Therefore, when reference is made to No. 1 cylinder or front main bearing, it is always the one nearest the timing gears. Cylinders, connecting rods, etc., are numbered from the front or timing gear end of the engine. All dimensions are given in inches and fractions of inches, except as otherwise noted. All weights and measures are in United States avoirdupois or liquid measure standards.

This book is divided into the following sections, which appear in the order named — Specifications, Operation, Lubrication, Description and Maintenance, Trouble Shooting, Clearances and Tools.

Where necessary to refer to accessories which are not furnished by the Hercules Motors Corporation, information and comments given are general and may not apply to the specific accessory used.

As an operator, you owe it to yourself to read this book carefully.

# SPECIFICATIONS

## MAIN BEARING (Standard Crankshaft)

	Three Cylinder	Four Cylinder	Six Cylinder
Number of Bearings .....	4	5	7
Bearing Diameter (Main) .....	2½" — 63.5 MM	2½" — 63.5 MM	2½" — 63.5 MM
Bearing Length (Front) .....	1⅞" — 33.3 MM	1⅞" — 33.3 MM	1⅞" — 33.3 MM
Bearing Length (Center) .....		2⅞" — 54.0 MM	2⅞" — 54.0 MM
Bearing Length (Rear) .....	1⅞" — 36.5 MM	1⅞" — 36.5 MM	1⅞" — 36.5 MM
Bearing Length (Intermediate) .....		1⅞" — 33.3 MM	1⅞" — 33.3 MM
Bearing Length (No. 2) .....	1⅞" — 33.3 MM		
Bearing Length (No. 3) .....	2⅞" — 54.0 MM		

## MAIN BEARING (Heavy Duty Crankshaft)

	Three Cylinder	Four Cylinder	Six Cylinder
Number of Bearings .....	4	5	7
Bearing Diameter (Main) .....	2⅞" — 73.0 MM	2⅞" — 73.0 MM	2⅞" — 73.0 MM
Bearing Length (Front) .....	1½" — 26.2 MM	1½" — 26.2 MM	1½" — 26.2 MM
Bearing Length (Center) .....		2⅞" — 54.0 MM	2⅞" — 54.0 MM
Bearing Length (Rear) .....	1½" — 26.2 MM	1½" — 26.2 MM	1½" — 26.2 MM
Bearing Length (Intermediate) .....		1½" — 26.2 MM	1½" — 26.2 MM
Bearing Length (No. 2) .....	1½" — 26.2 MM		
Bearing Length (No. 3) .....	2⅞" — 54.0 MM		

## CAMSHAFT BEARING

	Three Cylinder	Four Cylinder	Six Cylinder
Number of Bearings .....	3	4	4
Bearing Diameter .....	2¼" — 52.4 MM	2¼" — 52.4 MM	2¼" — 52.4 MM
Bearing Length (Front) .....	1⅞" — 27.0 MM	1⅞" — 27.0 MM	1⅞" — 27.0 MM
Bearing Length (Intermediate) .....	1⅞" — 20.6 MM	1⅞" — 20.6 MM	1⅞" — 20.6 MM
Bearing Length (Rear) .....	1⅞" — 27.0 MM	1⅞" — 27.0 MM	1⅞" — 27.0 MM

## CONNECTING ROD (Standard Crankshaft)

	Three Cylinder	Four Cylinder	Six Cylinder
Bearing Diameter .....	2" — 50.8 MM	2" — 50.8 MM	2" — 50.8 MM
Bearing Length .....	1½" — 38.1 MM	1½" — 38.1 MM	1½" — 38.1 MM
Rod Length (C to C) .....	8" — 203.2 MM	8" — 203.2 MM	8" — 203.2 MM

## CONNECTING ROD (Heavy Duty Crankshaft)

	Three Cylinder	Four Cylinder	Six Cylinder
Bearing Diameter .....	2½" — 63.5 MM	2½" — 63.5 MM	2½" — 63.5 MM
Bearing Length .....	1½" — 29.8 MM	1½" — 29.8 MM	1½" — 29.8 MM
Rod Length (C to C) .....	8" — 203.2 MM	8" — 203.2 MM	8" — 203.2 MM

## GENERAL DATA

Cooling .....	Centrifugal Pump
Generator Mounting .....	Standard Swivel Type Generators
Water Pump—Fan Assembly .....	Mounted in Front of Cylinder Block
Method of Suspension .....	3 or 4 Point
Flywheel .....	For Any Standard Clutch

## GENERAL DESCRIPTION AND FEATURES OF DESIGN

### CYLINDER BLOCK AND CRANKCASE

The cylinder block and crankcase are cast in one piece, in order to permit more efficient cooling, by water jacketing the cylinders the full length of the bore. This construction results in a very rigid unit, which provides a sturdy support for the crankshaft.

The cylinder block is so designed as to be reversible; that is, the crankshaft may be installed in the crankcase so that the camshaft may be on either the right-hand or the left-hand side of the engine. However, the timing gears and gear cover cannot be assembled to either end of the cylinder block. Therefore, it is essential that, when this engine is torn down for rebuilding, it be known and recorded which way the cylinder block is installed. That is, if the distributor or magneto is mounted on either the right or left-hand side of the engine.

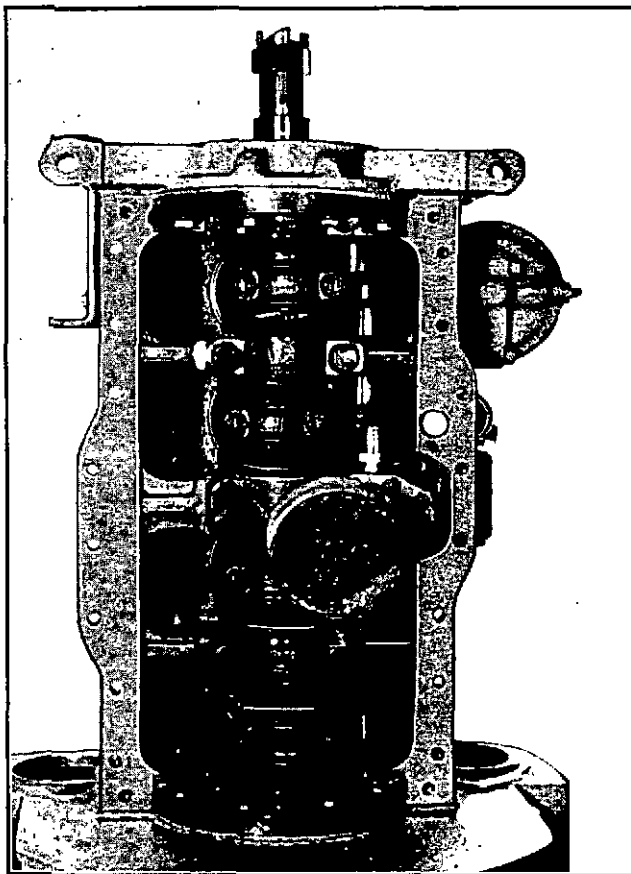

Illustration No. 1

### MAIN BEARINGS

The four cylinder engine has five main bearings and the six cylinder has seven main bearings. This permits a main bearing being placed on each side of each connecting rod bearing, see Illustration No. 1. This construction helps to eliminate vibration at high speeds. The center main bearing cap is held in position by four alloy steel cap screws  $\frac{1}{2}$ " in diameter, while the remaining bearing caps are held by two alloy steel cap screws  $\frac{9}{16}$ " in diameter.

The crankshaft end thrust is controlled by the center main bearing. This shell has suitable flanges on both sides of the bearing, which form a thrust bearing.

Precision or insert type bearings are used; in this construction there is a removable shell in each cap, as well as for the upper part, and the upper shell is interchangeable with the lower shell for each bearing. These bearing shells are completely finished before being put in place and no line reaming or scraping is required. This allows removal of the bearings to be easily accomplished. Each bearing shell has a small ear or projection which fits into a recess in the cylinder block or cap, which allows the ear or projection to rest against the adjoining case or cap to prevent the shell from rocking or rotating. These shells are approximately  $\frac{1}{16}$ " thick, and the bearing metals commonly used are harder and have a higher melting point than ordinary babbitt metal. This permits the use of a hardened crankshaft.

### CYLINDER HEAD

The cylinder head is a one piece casting and is detachable. The valve seats are a part of this casting while the valve guides are removable bushings. The head is held to the cylinder block by studs and screws; and, in order to insure against leaks, the head must be carefully drawn down by means of the stud nuts and screws which should be progressively tightened, working from the center of the head toward the ends.

A torque wrench is recommended for this operation. See "Wrench Tension" for recommended tensions. If a torque wrench is not available, a wrench approximately 18" long should be used for this operation.

## CONNECTING RODS AND PISTONS

Like the main bearings, the connecting rods have the precision or insert type of bearing construction. No shims are used; therefore, bearing adjustment is accomplished by installation of new bearing inserts.

The piston pin is of very large diameter and is of the full floating type. This means that the pin can rotate in either the piston bosses or in the bushing at the top end of the connecting rod, but the fit in the piston is intended to be much tighter than the fit in the connecting rod bushing. Consequently, the movement in the piston consists of a light, creeping action while the normal rotation of the pin occurs in the bushing in the connecting rod. The piston pin is prevented from moving endwise and making connection with the cylinder wall by means of snap rings, which are located in grooves machined in the bosses of the piston.

## CAMSHAFT

The camshaft is supported on bearings in the crankcase. Some bearings may be machined directly in the block, and no separate bushings used, while others may have removable bushings. At the center of the shaft is located the spiral gear, which meshes with the gear attached to the oil pump shaft and drives the oil pump. The distributor is also driven from this gear by a tongue and groove arrangement. The camshaft end thrust is controlled by a thrust plate located between the front camshaft bearing and the camshaft gear. This plate is held to the cylinder block by two cap screws.

## VALVES

The valves are installed in the cylinder head. The intake valve head is larger in diameter than the exhaust valve head in order to increase the efficiency and insure more power. Both intake and exhaust valves are forged from special alloy steel and the exhaust valves, in particular, are of high heat resisting material. The valves of some engines may be equipped with a rotocap which permits this valve to rotate slightly during the opening and closing cycles. The valve tappets are of the mushroom type and are hollow to allow the push rod to properly seat.

## OILING SYSTEM

The oil pump is of the gear type and is fastened to the block so that the suction end is in the oil pan oil sump and needs no priming. The oil pump is provided with a pressure release mechanism to control the oil pressure. The oil, under pressure, is delivered through a suitable passage in the crankcase, which extends from front to rear of the engine on the side opposite the camshaft. This passage is closed at either end by means of suitable threaded plugs. Radial holes are drilled from the crankshaft bearings to meet this horizontal oil passage, and this permits oil to be delivered, under pressure, to the main bearings and through drilled holes in the crankshaft to the connecting rod bearings. The camshaft bearings are also lubricated from this horizontal passage through suitable drilled holes. The rear camshaft bearing meters the oil which is carried through suitable passages up through the cylinder block and cylinder head studs to the rocker arms. The cylinder bores, tappets, and so forth, are lubricated by means of a mist of oil thrown off around the connecting rod bearings.

### REMEMBER

**Good Oil changed frequently . . . Oil Filter Elements replaced often . . .  
Breather and Air Cleaner kept clean and functioning properly . . . and  
Engine in good adjustment . . . .**

**Mean Longer Life to the Engine and Trouble-Free Operation**

## OPERATION

This section covers those items which are of particular interest to the operator and does not cover such work as might be required of a maintenance crew. This does not mean that an operator should not acquaint himself with the various subjects covered in other sections of this book.

### PRECAUTIONS

#### READ BEFORE STARTING THE ENGINE

The precautions listed below, if followed, will help eliminate operating difficulties and abnormal wear.

1. **Filters**—keep them clean—they are the guardians of your engine—dirty filters cause rapid wear and low engine output. See “**Oil Filters.**”
2. **Fuel**—keep it clean—do not use a dirty container to handle it—insist on the fuel being clean and acid-free when you get it. Procure it from a reputable company.
3. **Lubricating Oil**—keep it clean—drain the crankcase often. Use the best brands obtainable, having specifications as set forth in “**Lubrication.**”
4. Do not allow the **Oil Level** to fall much below the 4/4 mark on the bayonet gauge. As the lubricating oil is the medium for removing the friction heat in the bearings, the larger the volume of oil, the more heat it can absorb and dissipate. Do not fill above the 4/4 or full mark.
5. **Do Not Run The Engine** at any time without lubricating oil and a cooling solution (water or anti-freeze mixture).
6. Do not use oil, fuel oil or kerosene in the cooling solution or as a cooling medium, as these will be detrimental to the synthetic rubber water pump seal.
7. **Never Run The Engine** with the water or anti-freeze solution **boiling**. This allows the lubrication to break down and may seriously damage the engine.
8. Do not put cold water in an **Overheated Engine**. It may crack the cylinder head, block, etc. An overheated engine shows negligence in operation.
9. Do not allow the **Air Cleaners** to become clogged or to operate without all the connections being tight. Keep them clean and properly serviced. These units protect your engine from undue wear only when they are given intelligent care.
10. Never allow your **Batteries** to run low or dry of water. The plates will warp and ruin the battery.
11. **Do Not Attempt Starting The Engine** until the lubricating oil, water and fuel supply have been checked and the engine properly prepared for starting. See “**Starting and Operating Suggestions.**”
12. **Do Not Run The Engine** at high speed without load, as this will cause undue wear and shorten the engine's life.
13. **Do Not Idle The Engine** for long periods, as it is not only detrimental to the engine but also increases operating costs as you are using fuel without any benefit.
14. **Do Not Use The Engine As A Brake** in intermediate or low gear. The high engine speeds possible when using low or intermediate gear descending steep grades will turn the engine much faster than the speed for which it is designed, and damage will result unless the vehicle speed is held to that used in the same gears on the level.
15. **Never Allow** the engine to **Run Without The Oil Pressure** showing on the gauge. Damage from lack of lubrication will result.
16. Do not allow the fuel in the tank to run low, as it may allow the line to the fuel pump to uncover long enough to fill the lines with air and cause the engine to stop, resulting in lost time taken for repriming.
17. *Loss of power, erratic running and poor performance often result from **Air In The Fuel System or Vapor Lock.** Be sure there are no leaks in the fuel lines and filters which will allow this condition to exist.*
18. Remember dirt, grit, water, lint or any foreign matter in the fuel and lubricating oil are detrimental to the engine and it is your duty, as an operator, to see that they do not get into the engine.

19. Do not attempt to start the engine in cold weather until you have read "Cold Weather Starting."
20. Some external heat will help starting in cold weather and saves the batteries.
21. Never run the starting motor longer than 30 seconds at one time without a rest period of at least one minute before allowing it to run again. Failure to follow this procedure may result in a burned out starting motor.
22. **CAUTION:** After installing the cylinder head, always retighten the cylinder head cap screws when the engine is at operating temperature. See "Cylinder Head" for tightening procedure.
23. Do not attempt to start or operate this engine without first reading the instructions in this book carefully. As an operator, you owe it to yourself.

## STOPPING THE ENGINE

**CAUTION:** Always be sure the proper method of stopping the equipment and engine is fully understood before starting the engine.

1. If the engine has been operating at or near full load, it should be allowed to run at fast idle (600 to 800 RPM) for one or two minutes after load is removed before being stopped. This allows internal engine temperatures to equalize.
2. If the atmospheric temperature is below freezing and no anti-freeze solution is used, the complete water circulating system should be drained. This includes the engine water jackets, water pump, radiator and all water pipes.
3. If an anti-freeze solution is used, the solution should be checked with a hydrometer to make sure the solution will not freeze. It is best to have a solution that will not freeze at temperatures far below those then being experienced.
4. Do not fill the batteries with water when shutting down, as this makes them more liable to freezing. Fill the batteries just before starting up for the day's run.

**NOTE:**—If the engine is kept in warm storage or is located in a warm building where freezing is not liable, No. 2, No. 3 and No. 4 can be disregarded.

## STARTING AND OPERATING SUGGESTIONS

1. Use a good brand of fuel.
2. Use only the best lubricating oil obtainable. See "Lubrication."
3. An SAE 20 oil is a good grade to start with (unless extreme cold weather is prevalent); from this, the proper grade can be determined. See "Lubrication" for complete information relative to the grade to use for the climatic conditions encountered.
4. Fill the cooling system with clean water (if in a locality where the water has a large percentage of dissolved minerals or is alkaline—use rain water). Allow sufficient time for the water to seek the lowest level, then complete filling. Run the engine and recheck the level.
5. Be sure the batteries are hooked up properly before pressing the starter button.
6. If possible, turn the engine over three or four times by hand to be sure there is nothing sticking or water has not seeped into the cylinder, as the starting motor has sufficient power to bend or break certain parts should anything be out of place.
7. Be sure all fuel line connections are tight and the fuel system properly primed.
8. Always follow the starting instructions outlined below to eliminate difficulties.

## STARTING THE ENGINE

**First Time The Engine Started** or starting the engine after a long period of shutdown.

1. Fill the fuel tank with suitable fuel.
2. Fill the cooling system with clean, pure water, or, if the atmosphere is below freezing and the engine is to stand or operate in these temperatures, use an anti-freeze solution.
3. Fill the crankcase with suitable lubricating oil to the 4/4 or full mark on the oil gauge rod. See "Lubrication" and "Bayonet Gauge."
4. If possible, turn the engine over by means of a hand crank three or four times to start oil circulation and distribute the oil already on the surfaces. This hand cranking also prevents possibilities of damage due to water having accumulated in the cylinders.

## OPERATION

5. In addition to the procedure just described, check the lubrication of the generator, starter, fan, water pump and any other accessories. Check the air cleaners to make sure there are no obstructions, that they are properly installed, and are clean, and that they are properly filled with oil (if oil bath cleaners are used).
6. Check the entire electrical system to be sure there are no loose connections and all component parts are properly connected together.
7. See that no loose bars, tools, parts, etc., are lying in, or on, any part of the engine, as they could cause serious damage or wreckage of the engine or bodily injury to anyone near.
8. **Never attempt to start with a wide-open throttle.** Have the throttle open not more than one-fifth of the total opening.
9. Turn the ignition switch to "On." Start the engine by operating the starting motor switch. If all of the foregoing instructions have been properly followed and the proper grade and type of fuel has been used, the engine will start at once.

**Usual Routine Way of Starting the Engine.** If the engine has been operating recently and nothing has been removed or repaired since it last operated, the following is all that is necessary to start:

1. Check fuel supply.
2. Check the lubricating oil in the engine base with the gauge rod. Be sure the oil is to the 4/4 or full mark on the rod. See Illustration No. 6.
3. Check the cooling solution.
4. Inspect the installation to see that all is in good order and tight and no loose tools, bars or parts are lying on the engine.
5. **Never attempt to start the engine with a wide-open throttle.** Have the throttle open not more than one-fifth of the total opening.
6. Start the engine by operating the starter switch after turning the ignition "On."

### OPERATING INSTRUCTIONS AFTER STARTING

After the engine has started, an inspection of the whole engine unit should be made to make sure all parts are functioning properly.

1. Look at the lubricating oil gauge. If no pressure shows after the engine has run 10 to 12 seconds, shut down the engine and ascertain what the trouble may be. With the bearings in good condition and the proper grade of oil, the pressure should be 35 to 45 pounds at full engine speed. If the oil is very cold or heavy, this pressure may be much higher. As the oil heats up, the pressure will reduce.
2. Check the water circulation. If no water is flowing, shut down the engine and ascertain what the trouble may be. Never operate with the water boiling, as this heat on the cylinder walls breaks down the oil film and also causes considerable water loss due to evaporation.
3. See that no loose tools or parts are lying on, or near, the unit, as they might fall into a place where they would cause damage or personal injury.
4. Observe the engine operation for smoothness, quietness and exhaust condition. If the fuel is up to specifications and has the proper ignition qualities, the engine may still run raggedly because a cylinder or two is firing irregularly due to being cold. As the engine begins to warm up, however, all cylinders should fire regularly. If they do not, trace out the trouble, some hints of which will be found in "Engine Trouble Shooting."
5. See that there is an adequate supply of fuel in the tank and that fuel is being delivered to the fuel pump. The delivery can be checked by slightly loosening the nut connecting the supply pipe to the carburetor; if a good quantity of fuel appears, it is an indication that the fuel pump is being supplied with sufficient fuel. If no fuel or very little appears, shut down the engine and check the supply tank again. If the fuel supply is adequate, check the fuel line from the tank to the pump for leaks from loose connections, broken nuts and cracked or broken lines. Also check the lines for obstructions inside or having been pinched closed or nearly so. If the lines are found satisfactory, check the pump for a broken diaphragm, springs and worn or broken valves.
6. Check and see that there are no oil or water leaks.
7. Clean the lubricating oil filter often. This will insure maximum efficiency from this unit and does not require much time or energy to accomplish.

## HERCULES MOTORS CORPORATION

8. Keep all the fuel filters clean and give them regular attention.
9. Observe the fan and belt operation. Loose fan belts allow slippage, which reduces the efficiency of the fan and wears the belts out rapidly. Never allow the fan to run without any lubricant but do not over-lubricate, as it will throw off the excess on the surrounding parts.
10. See that the radiator, if one is used, is free of obstructions between the fins or tubes, as they will obstruct the air flow and reduce the cooling efficiency of the radiator unit.

### COLD WEATHER STARTING

At extremely low temperatures, difficulty may be encountered in starting the engine due to (a) battery charge or output being low due to temperatures or (b) gasoline with vapor pressure too low to readily vaporize.

In starting any engine, and particularly a cold engine, do not allow it to run up to governed speed or do not run the engine much over 800 or 1000 RPM until the oil has become warm enough to circulate and the water or cooling solution has become warm enough to take the chill off the cylinder block. This usually takes four or five minutes if the engine is equipped with a thermostat. A longer period is generally required for engines not so equipped; these engines should have the radiator covered for the first few minutes in order to allow the water or cooling solution to warm up. If the unit is not equipped with a thermo-gauge or thermometer, this can be then checked by placing the hand on the cylinder block or cylinder head and, as soon as the engine becomes warm enough, can be run up to maximum speed. This is probably the most important phase of the engine operation, as damage can result in the first few seconds of running if the engine is allowed to run maximum load and maximum speed before lubrication has been established and before the parts have started to warm up normally.

### COLD WEATHER STARTING SUGGESTIONS

If ignition and carburetor are correct, starting in cold weather can be made less difficult by observing the following suggestions.

1. Late ignition timing causes hard starting. (Magneto impulse coupling should click or release on, or slightly after, top dead center.)
2. Never attempt to start with a wide-open throttle. Have the throttle open not more than one-fifth of the total opening.
3. Close the carburetor choke and turn the engine several times before the ignition switch is closed, if the engine is hand cranked.
4. Close the ignition switch and keep the choke closed nearly all the way, then crank the engine over in the same way as has been followed in warmer weather.
5. When the engine starts to fire, keep the choke partially closed until the engine warms up sufficiently to run normally.
6. Filling the cooling system with hot water will assist starting.
7. Thin oil, such as 10W or 20W, will make cranking easier.
8. Cheap gasoline makes cold weather starting very difficult.
9. Be sure the gasoline flows through the carburetor. Ice may have blocked the gasoline due to water in the gasoline.
10. If the engine has been standing idle for several days, remove the spark plugs and dry out; at the same time, pour a tablespoon of oil in each spark plug hole.

**REMEMBER**  
**PREVENTATIVE MAINTENANCE** Cuts Operation Expense  
And  
Often Prevents Expensive Delays

## ENGINE STORAGE

If the engines are to be stored or left idle for any length of time, certain preparations should be made for proper storage of the engine.

1. Engines which have been operating on leaded gasoline should be run on unleaded or standard white gasoline for at least 10 minutes in addition to the time required to run out the leaded gasoline in the lines and carburetor.
2. The crankcase should be filled to the 4/4 mark on the bayonet gauge with an oil similar to the following:

Shell ENSIS 412. Specifications 2-126, Grade 2

Gulf No-Rust Engine Oil, Grade 2

This oil should be placed in the engine crankcase at the beginning of the run outlined in paragraph 1.

The above oils are graded the same as regular motor oil according to SAE weight. Therefore, the proper weight of oil for the climatic conditions should be chosen to facilitate starting.

In cases where the engine is to stand idle for an extended period of time, approximately 1 quart of this oil should be poured into the carburetor air intake while the engine is operating at a fast idle (800 to 1000 RPM). Gradually increase the amount of oil through the carburetor until the motor stalls or stops. Shut off the ignition switch.

3. In damp or humid climates, seal off all openings with a moisture-proof tape (breather, air intake, et cetera).

The above methods have proven successful; however, Hercules Motors Corporation cannot assume responsibility for engine storage.

## LUBRICATION

### DESCRIPTION OF THE LUBRICATING SYSTEM

The lubricating system on this engine is the forced feed type to all main and connecting rod bearings by means of a gear type pressure pump. The oil pump is driven through a suitable gear arrangement at the center of the camshaft. The pump picks up the oil from the center sump of the oil pan and delivers it to a drilled passage in the block. From there, it flows through an oil manifold and through various leads to the main bearings. From the main bearings, the oil flows through suitable drilled holes in the crankshaft to the connecting rod bearings. The bypass type pressure regulator, consisting of a spring loaded piston, is incorporated in the oil pump body. The idler shaft and accessory shaft are pressure lubricated. The cam bearings, valve tappets, valve stems and cylinders are lubricated by the mist of oil thrown off by the main and connecting rod bearings.

### LUBRICATION INSTRUCTIONS

**Oil Level.** The level of the oil in the crankcase is determined by a bayonet or dip stick type of gauge. Wipe off the gauge and reinsert to determine the oil level accurately. The oil level should be maintained at, or near, the 4/4 (or FULL) mark on the gauge. See Illustration No. 6.

### OIL CHANGING

Frequency of oil changes depends upon the application of the engine and the severity of the operation. Under normal operating conditions the oil should be changed every 50 hours. A new or reconditioned engine should have the oil changed more often for the first 100 hours of operation. (Suggest first change after 20 hours.)

Frequent and regular oil changing, together with the use of good oil, is low cost insurance against expensive repairs.

### USE GOOD OIL

The Hercules Motors Corporation recommends that only the best quality, heavy-duty, detergent type oil produced by recognized concerns familiar with the lubrication requirements of internal combustion engines be used. An oil having an A.P.I. service designation of "MS" is recommended.



## DESCRIPTION AND MAINTENANCE

This section covers a brief description and function of the various parts of the engine along with complete instructions covering the repair, disassembly and reassembly of the various component parts of the GO series engine.

This section has the various subjects arranged alphabetically for convenience in locating.

### AIR CLEANER

Since dirt is the greatest enemy of any internal combustion engine, it is necessary to take every precaution to prevent it from entering the engine. This is usually accomplished by an oil bath type air cleaner or filter. There are many types of air cleaners, two different types are shown in Illustrations No. 2 and No. 3. The oil bath air filters generally used accumulate the dirt, which they separate from the incoming air, in the screen and oil reservoir. As this dirt builds up, due to lack of proper maintenance, it has an action similar to closing the choke valve. Since both cause a restriction, which increases the suction on the carburetor jets, it has a tendency to cause loss of power, excessive fuel consumption, internal engine deposits, dilution of the lubricating oil and results in short engine life. Very little restriction, due to dirty air filters, is sufficient to create a very rich mixture. Therefore, one of the most essential preventive measures is proper maintenance of the air intake filter. This unit should be checked at least once a day and, if operating in dusty conditions, may require cleaning every six to eight hours.

It is also essential that all connections between the air cleaner and manifold be absolutely air tight. It is possible, under certain conditions, for enough abrasive laden air to be drawn into the engine through a loose connection to cause rapid wear of the pistons, rings and upper cylinder surfaces.

Two typical types of popular oil bath air cleaners are shown, disassembled for clarity, in Illustrations No. 2 and No. 3. They differ in details of construction but their functions are the same; therefore, they require the same basic service procedure.



Illustration No. 2

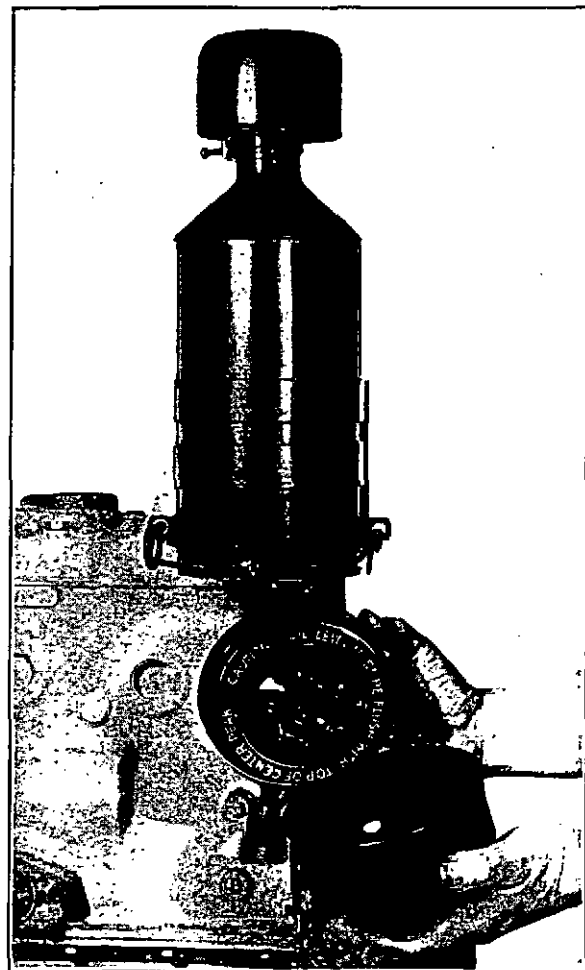

Illustration No. 3

## HERCULES MOTORS CORPORATION

At least once a day the oil cup should be checked and serviced, if necessary. If operating in very dusty conditions, the air cleaner may require cleaning and servicing every six to eight hours.

Each 100 to 150 hours, or until a satisfactory maintenance schedule suited to actual operating conditions can be worked out, the air cleaner should be removed from the engine, thoroughly washed and cleaned. The oil reservoir and screen should be soaked and washed with solvent or gasoline and blown dry with compressed air, if available. If compressed air is not available, wipe the air cleaner bowl dry and shake the screen as dry as possible. Before reassembling the cleaner, dip the screen in clean lubricating oil and fill the reservoir to the proper level (use the same grade as used in the engine crankcase). Inspect the bowl gasket and, if broken or torn, replace with a new gasket. Reassemble the air cleaner and install the complete unit on the engine, making sure all connections between the air cleaner and manifold are air tight.

**NOTE:**—If a precleaner is used, it also must be removed and serviced regularly.

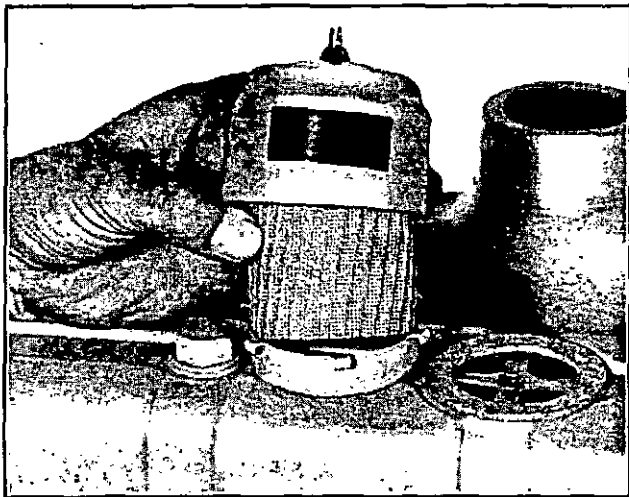

Illustration No. 4

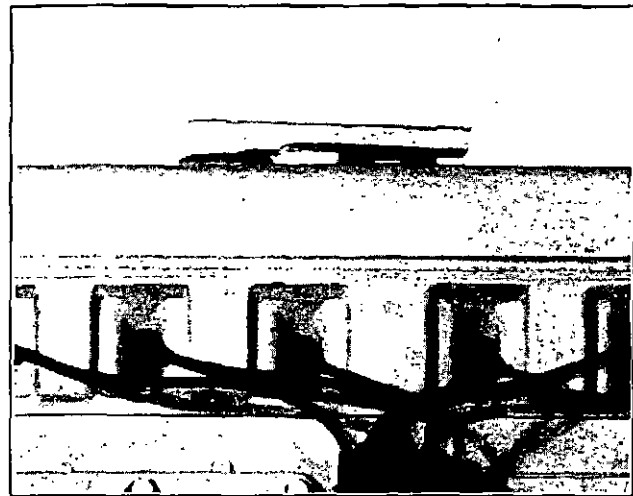

Illustration No. 5

### BREATHER

The breather allows clean air to enter or accumulated gases to escape from the crankcase, the normal process of engine breathing. The two breathers illustrated, Illustrations No. 4 and No. 5, are the screen type and are easily removed for servicing.

They should be inspected at frequent and regular intervals, the period depending on the kind or conditions of operation. If required, all parts should be thoroughly cleaned with solvent and blown dry with compressed air to insure free breathing action.

Before reassembly to the engine, apply a small quantity of lubricating oil (the same as used in the engine crankcase) to the screens.

### BAYONET GAUGE

The bayonet gauge is used to determine the amount of oil in the oil pan and is readily accessible. The oil level in the oil pan should always be maintained at, or near, the FULL mark, Illustration No. 6. When the oil level drops to the ADD mark on the gauge, add one U. S. quart.

### BELLHOUSING

The bellhousing is a casting which covers the rear end of the cylinder block and oil pan. There are many types of housings used, some of which may be a plate type housing and others which form a complete housing for the flywheel and clutch, to which the transmission, torque converter or other drive mechanism is attached. The bellhousing usually forms the rear motor support.

## DESCRIPTION AND MAINTENANCE

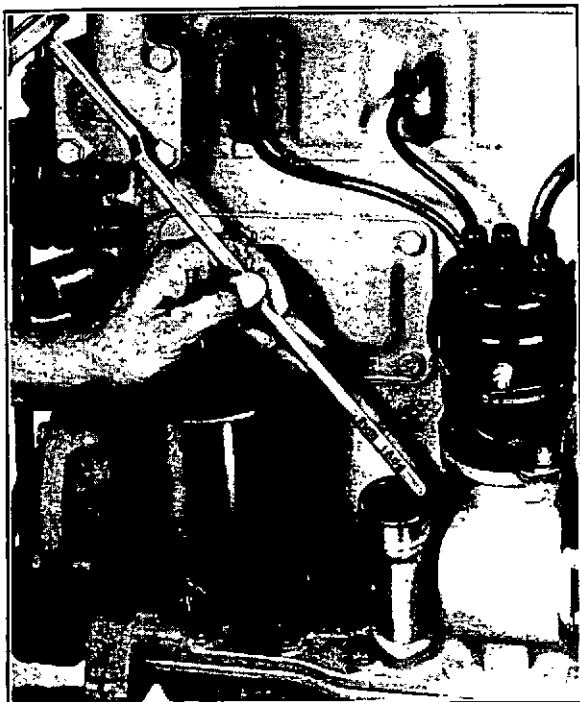

Illustration No. 6

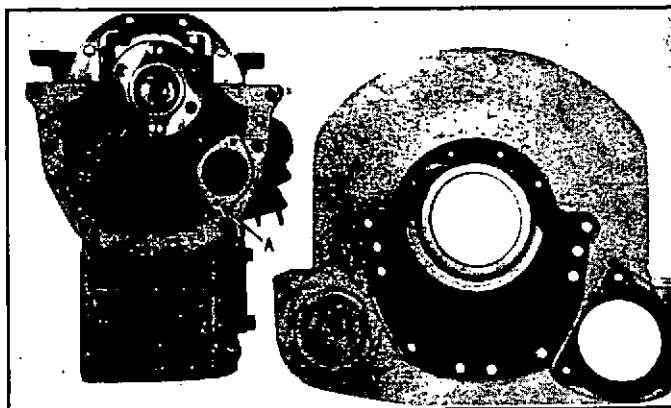

Illustration No. 7

### TO REMOVE THE BELLHOUSING

1. Drain the crankcase oil.
  2. Remove the clutch or power take-off mechanism and oil pan.
  3. Remove the flywheel. See "Flywheel."
4. If the engine is in the unit, place suitable supports under the rear of the crankcase to support the engine.
  5. Remove the rear motor support screws.
  6. Remove the bellhousing attaching screws and stud nuts.
  7. Pull the bellhousing away from the engine. Illustration No. 7. It may be necessary to tap the housing with a soft hammer to loosen from the dowels or gaskets sticking to the block.

### TO INSTALL THE BELLHOUSING

1. Install a new oil seal in the bellhousing, using a small amount of sealing compound in the bore before pressing in the seal. Cement a new gasket to the bellhousing, allowing cement to dry sufficiently to prevent the gasket from skidding.
2. Clean and polish the oil seal surface of the crankshaft, making sure there are no nicks or scratches present. Crocus cloth or very fine polishing cloth is suitable for this purpose.
3. Apply a thin coat of oil soap to the seal and the seal surface of the crankshaft. Be sure the hole marked (A), Illustration No. 7, is plugged with the socket head screw. Using care in placing the oil seal over the crankshaft and making sure that the dowels properly enter their respective holes, assemble the bellhousing to the engine and secure in place with the screws and nuts as removed. Check the bellhousing mounting dowels to be sure that they are tight and in good condition.
4. Install the rear motor support screws and remove the jack or block from under the crankcase.
5. Install the flywheel. See "Flywheel."
6. Install the clutch or power take-off mechanism and oil pan.
7. Fill the crankcase to the proper level with the correct grade of lubricating oil.

### CAMSHAFT

The camshaft is supported on three or four (depending on the model) large diameter pressure lubricated bearings in the crankcase and is driven by means of a suitable gear which meshes with the crankshaft gear.

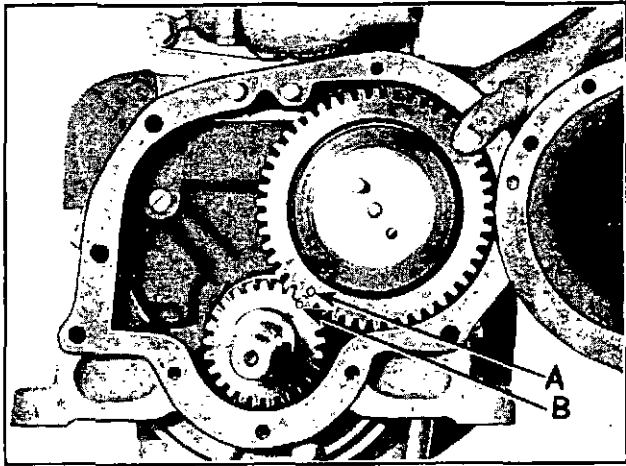

Illustration No. 8

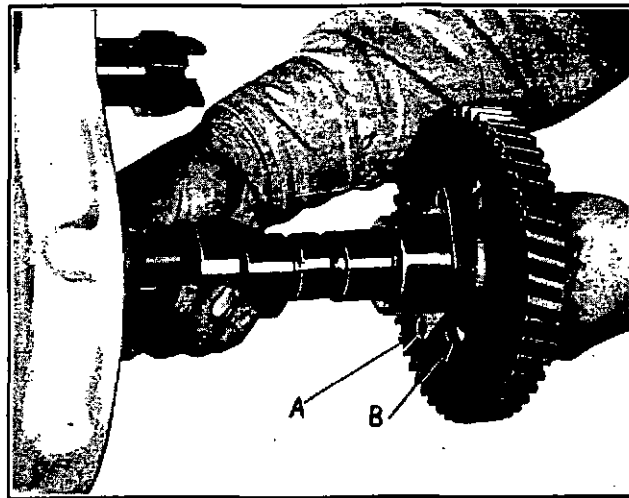

Illustration No. 9

The timing of these two gears requires no check of position of the valve. It is only necessary to line up the punch marks on the two gears, the cam gear being shown as (A) and the crank gear as (B) in Illustration No. 8.

The camshaft end play is controlled by a thrust plate (A), Illustration No. 9, located between the front camshaft bearing and the camshaft gear. Correct end play of .0015" to .0035" is regulated by the thickness of the thrust plate.

To decrease end play, it is permissible to remove by draw filing a small amount of metal from the camshaft gear hub on which the thrust plate rides.

To increase end play, it will be necessary to add a shim between the camshaft gear hub and the camshaft bearing or, using a piece of very fine emery cloth on a surface plate, polish the thrust plate to the desired thickness.

### TO REMOVE THE CAMSHAFT

Assuming that the radiator, and so forth, have been removed, the camshaft may be removed, as follows, without removing the engine from the chassis.

1. Drain the lubricating oil and remove the oil pan.
2. Turn the engine over until No. 1 cylinder is on top dead center and remove the oil pump.
3. Disconnect and remove the distributor.
4. Remove the fan blade and belt for easier access to the gear cover and gears.
5. Remove the crank grab nut and fan drive pulley.
6. Disconnect the governor linkage and remove the gear cover. See "Gear Cover."
7. Remove the governor parts. See "Governor."
8. Remove the rocker arm cover, rocker arms and push rods.
9. Valve tappets must be held in the "up" position in order to remove and insert the camshaft. One method of accomplishing this is to make a holder, Illustration No. 10, from music wire by bending a "V" on one end of the wire. This holder may be inserted into the hollow part of the tappet and the tappet lifted away from the camshaft. This holder is then bent over the push rod hole edge of the cylinder head so that the tappet will remain in this position. Use one wire for each tappet.

**NOTE:**—To remove and assemble the camshaft to the engine with the engine out of the chassis, the same procedure is followed, except Item No. 9 is disregarded. With the engine out of the chassis, it is only necessary to set the engine on the bellhousing or upside down (support the engine with suitable blocks so that the cylinder head studs will clear), push the tappets to the "up" position and remove the camshaft.

## DESCRIPTION AND MAINTENANCE

10. With the tappets in the raised position, rotate the engine until the two holes in the camshaft gear expose the thrust plate attaching screws, Illustration No. 11.

11. Remove the thrust plate attaching screws and pull the camshaft forward out of the engine block.

Inspect the camshaft lobes, oil pump gear, journals, etc., for wear or damage. Also, inspect the thrust plate for clearance. If any of the parts need replacement or adjustment, disassemble the camshaft and drive gear as follows:

Remove the nut, place the shaft in an arbor press and, with suitable supports under the gears, press the shaft out of the gear.

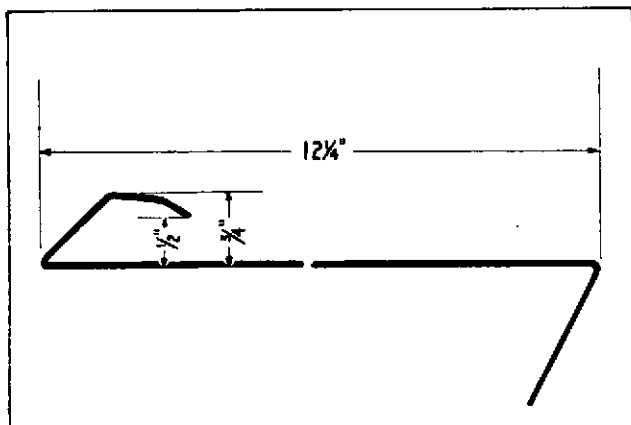

Illustration No. 10

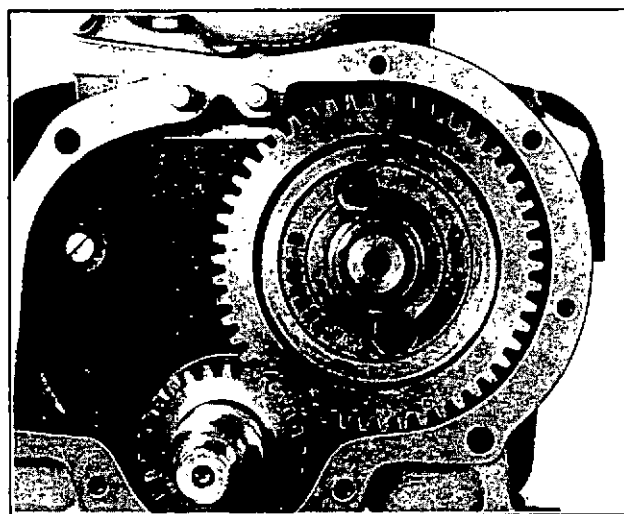

Illustration No. 11

## CARBURETOR

A carburetor is an accessory designed to mix gasoline and air in proper proportions and to furnish this proportionate mixture to the engine under varying operating conditions.

It is essential to clearly recognize that the function of the carburetor cannot extend beyond the proportionate mixing of fuel and air. This knowledge will avoid many false leads in diagnosing so-called "carburetor troubles." Bear in mind that the carburetor delivers the proper mixture into the manifold. The manifold carries this mixture to the cylinder. In the cylinder, the mixture is compressed by the piston. While under compression, a spark from the spark plug ignites the fuel mixture. The explosion caused by igniting the fuel mixture causes the piston to travel downward in the cylinder, rotating the crankshaft, etc.

This seems to be carrying the subject a long way from the carburetor, but it is done only to point out that all of these other parts of the combustion system can affect the results obtained from the fuel and air mixture which was prepared by the carburetor.

### OPERATION

Since it is not possible to discuss all makes and models of carburetors in a book of this type the Zenith Compound Nozzle system, Illustration No. 12, of carburetion will be used to illustrate this text. This consists of the Main Jet, directly connecting fuel in the bowl with the air stream through the Discharge Tube; and the Compensation Jet which flows into an open well connected with the air stream through the Supplemental Jet. The main jet flows vary with suction and deliver an increasing amount of fuel as the suction increases. The open well kills suction on the compensating jet so it flows the same under all suctions. In combination, the rich and lean jets give an average mixture of correct proportion.

Idling, acceleration and economizer action are provided by the idling and acceleration systems described in detail on the following pages.

**NORMAL RUNNING:** Refer to Illustration No. 12. On part throttle operation (between idling and full power) the fuel is measured by the main and compensating jets, the former being more effective at higher and the latter at lower speeds. The air is measured by the Venturi and the fuel is carried into the air stream

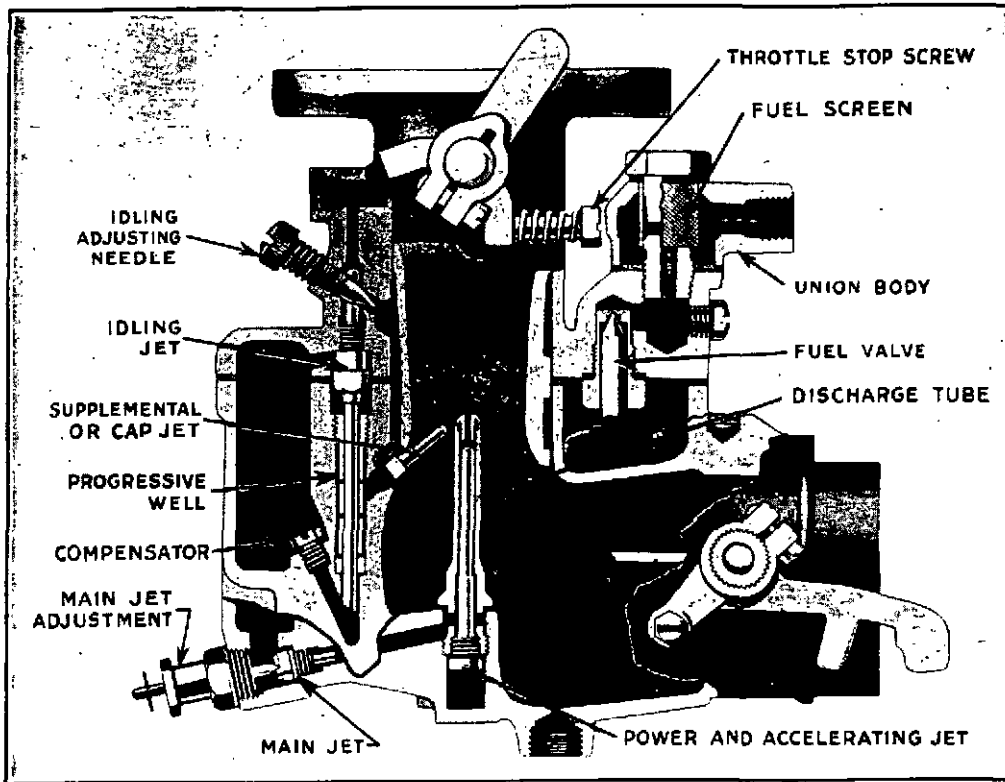

Illustration No. 12

slightly above the venturi throat from the main and compensating jets by the discharge tube and supplemental jets, respectively. These jets are of such size as to give a very lean and economical mixture.

**IDLING:** The idling system consists of an Idling Jet and tube to supply the fuel, an Idling Needle Valve to correct the idling mixture and a channel to carry the mixture into the carburetor barrel at the edge of the throttle. The desired idling speed is set by the stop screw on the throttle lever.

The idling system functions only while starting and idling. When the throttle is opened past the idling position the fuel goes the other way through the discharge tube and supplemental jet and the idling system is automatically out of operation.

**FULL POWER AND ACCELERATION:** Full power, either for top speed or hard pulling, requires a richer mixture than part throttle operation. So does acceleration. See Illustration No. 13.

This additional richness of mixture is provided by means of the accelerating and economizer system feeding through the Power and Accelerating Jet, its fuel stream merging with that of the main jet at the top of the discharge tube.

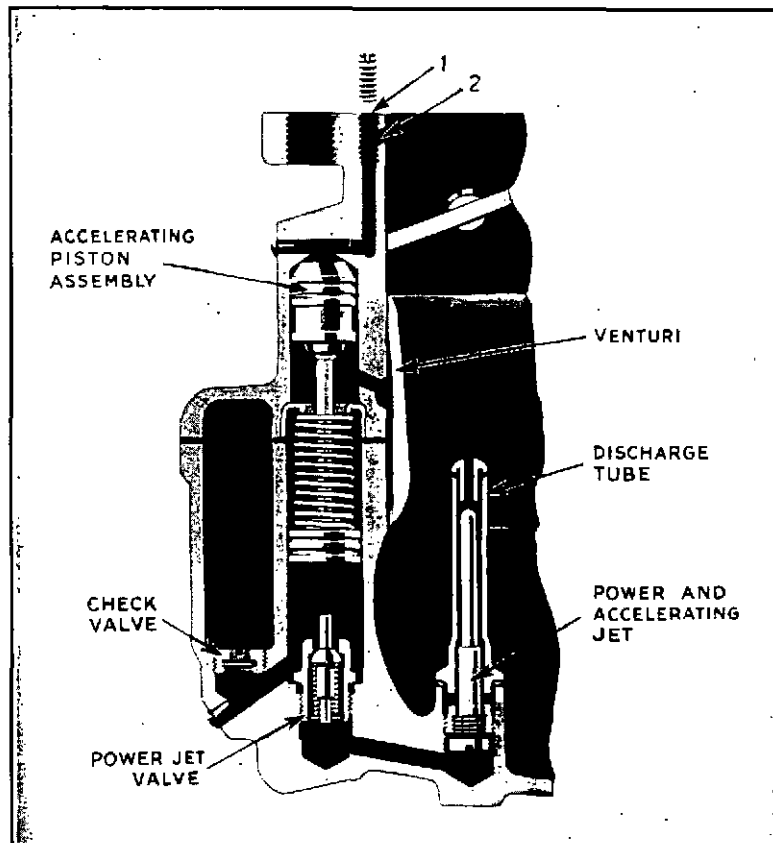

Illustration No. 13

## DESCRIPTION AND MAINTENANCE

Under part throttle, the suction (or vacuum) above the throttle is higher than when the throttle is open. This suction holds up the Economizer and Accelerating Piston Assembly. The Check Valve is open and the Economizer Valve is closed, thus shutting off fuel from the power and accelerating jet.

When the throttle is opened the suction falls, and so does the piston. The falling piston builds up a pressure below it, which forces the check valve to its seat, thus preventing the fuel from being forced back into the bowl. The piston falls on the economizer valve pushing it open, and the fuel displaced by the piston is forced out through the power jet. This is the accelerating charge.

If the throttle is held open, the piston will remain at the bottom holding the economizer valve open. This allows the fuel to continue flowing through the power and accelerating jet. This jet has a measuring hole in its tip which measures only enough additional fuel to develop full power.

When the throttle is partly closed the suction increases above it, the piston is drawn up to the top, the economizer valve closes and only a very economical amount of fuel can be fed to the engine.

### AIR CLEANER AND AIR FILTER RESTRICTION—AFFECT ON CARBURETION

Most air filters, now used on gasoline engine carburetors, accumulate the dirt they separate from the incoming air. As this dirt builds up, it has an action similar to closing the choke valve. Both cause restriction and this increases the suction on the carburetor jets. Very little increase in suction is sufficient to create a mixture so rich that it will not only seriously impair engine operation but will also dilute the oil and cause as much wear as dirt. See "Air Cleaner."

### CONNECTING ROD

The connecting rods are heavy alloy steel forgings with precision type bearings for the shaft and bronze bushings for the piston pins. With this precision or insert shell type bearing, the cap and rod is split slightly below center so that the bearing split opposite the locking lugs does not match with the split in the forging. No shims are used and, therefore, when reconditioning of the bearings is necessary, only the bearing shells need to be replaced.

**CAUTION:**—Do not file or grind the caps, as new bearings cannot be installed in a connecting rod that has been filed.

**NOTE:**—As built at the factory, the connecting rods and caps are marked on the camshaft side and to the front of the engine with the cylinder number in which they are used.

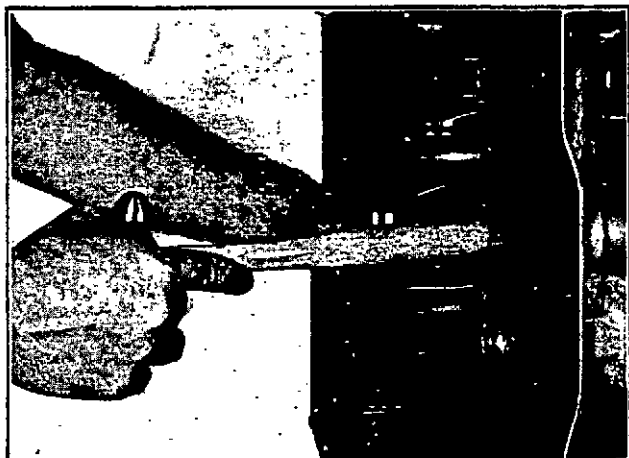

Illustration No. 14

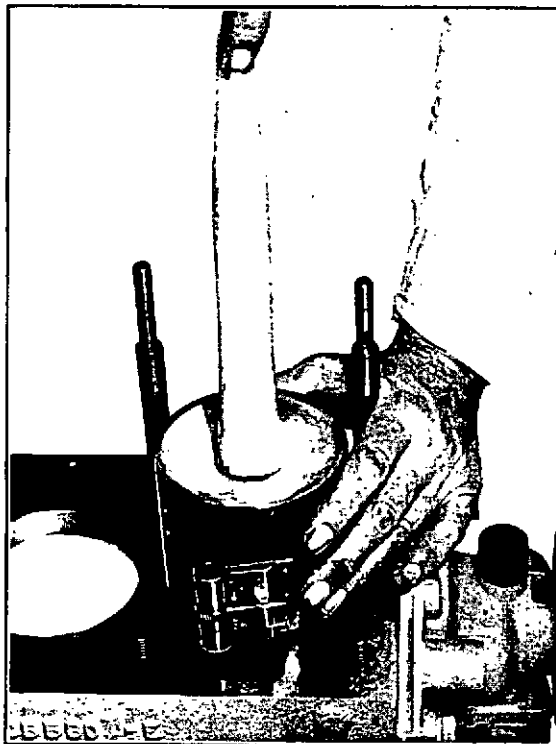

Illustration No. 15

### TO REMOVE THE CONNECTING RODS

**CAUTION:**—Connecting rods and caps are matched—keep them paired together, as otherwise they cannot be reinstalled.

1. Drain the radiator and disconnect the hoses.
2. Remove the thermostat housing and thermostat so that the water pump bypass hose can be removed from the water pump. Also, disconnect the water temperature gauge thermocouple.
3. Disconnect and remove the carburetor from the manifold.
4. Disconnect the exhaust pipe from the manifold.
5. *Disconnect the wires and remove the distributor from the engine.*
6. Remove the cylinder head cover, rocker arm assemblies and push rods.
7. Remove the cylinder head screws and nuts and lift the cylinder head assembly carefully from the engine (manifold may be removed with the head).
8. Remove the oil pan and crank the engine so that No. 1 cylinder is in firing position and remove the oil pump. If a tachometer drive is used, this must be removed before the oil pump can be removed.
9. Carefully scrape the carbon deposit from the top of each cylinder bore so that the pistons can be removed without damage to the rings.
10. Turn the engine so that No. 1 and No. 4 connecting rod caps can be removed and the piston and rod assembly pushed carefully upward with a block of wood or hammer handle, Illustration No. 14, to remove from the engine.

**NOTE:**—Keep the rod caps and bearings of each respective rod together—do not mix.

11. Turn the engine, as required, so that the other rods and pistons may be removed.

### TO DISCONNECT THE CONNECTING RODS FROM THE PISTONS

Remove the piston pin retaining rings and push the pin out of the piston and connecting rod bushing. The pistons may be heated in boiling water to facilitate removal of the piston pins.

Inspect the piston pin and bushing for wear and replace, if necessary. If new parts are used, check the connecting rod alignment on a standard aligning fixture.

### TO INSTALL THE CONNECTING RODS

1. Assemble the connecting rod and piston and insert the retaining rings.

**NOTE:**—To make it easier to assemble these parts, the piston may be heated in boiling water for a few minutes. **Do not heat the piston pin.**

2. Inspect the crankshaft for any rough or scored marks that might damage the connecting rod bearing. If any rough marks are found, use an oil stone, very fine emery cloth or Crocus cloth to polish the shaft. Clean the shaft thoroughly after polishing.
3. Install the piston rings on the pistons. See "Piston Rings."
4. Select the proper piston and connecting rod assembly and turn the crankshaft so that it is in the correct position.
5. Apply a liberal coat of lubricating oil to the cylinder bores, pistons, rings and piston pin. Space the piston rings so that no two slots are in line.
6. With the piston rings compressed as shown in Illustration No. 15, use a hammer handle or block of wood to force the piston and rings into the cylinder bore. At the same time, use care that the connecting rod is in line with the crankshaft journal.
7. With the piston entirely in the cylinder bore, insert the upper shell and pull the connecting rod down to the crankshaft.

## DESCRIPTION AND MAINTENANCE

---

8. Place a  $\frac{1}{4}$ " x  $\frac{1}{2}$ " x .003" piece of feeler stock in the cap. Place the lower shell in the cap and assemble the cap to the connecting rod. Tighten the cap screws to proper tension and try the connecting rod for side movement. The connecting rod should move sideways with a firm pressure of the hand. After obtaining the proper movement of the rod in the above manner, remove the piece of feeler stock and reassemble the connecting rod cap. Tighten the screws, as before, and again try the side movement of the rod. It should move easily. See "Clearance Table" for proper clearance and "Wrench Tension" for proper nut tension. If no torque wrench is available, this tension would require a tight pull on a 12" wrench.
9. Repeat the above operations for all connecting rods.
10. Install the cotter pins.
11. Install the oil pump. See "Oil Pump."
12. Inspect the top of the cylinder block and pistons. Be sure no foreign matter is present and install the cylinder head gasket.
13. Install the cylinder head. See "Cylinder Head."
14. Insert the valve push rods and install the rocker arm assemblies.
15. Adjust the tappets to the proper clearance. See "Valves."
16. Install the cylinder head cover, using a new gasket. Install the nuts and washers as removed.
17. Install the thermostat, thermostat housing and water pump bypass hose and connect the water temperature gauge thermocouple.
18. Install the distributor and connecting wires. See "Distributor."
19. Install and connect the carburetor and connect the exhaust pipe to the manifold.
20. Connect the radiator hoses and fill the radiator with clean water or anti-freeze.
21. Install the oil pan, using new gaskets, and fill the crankcase with the proper grade of lubricating oil.

### CONNECTING ROD BEARING REPLACEMENT

If excessive clearance develops between the shaft and bearing shells, new bearing shells should be installed. If the clearance is excessive with the new bearings, grind the shaft and use undersized bearings.

The connecting rod bearings may be replaced as outlined below.

1. Remove the oil pan. See "Oil Pan."
2. Locate the crankshaft so the connecting rod cap can be removed.
3. Remove the cotter pins, nuts and cap screws.
4. With a soft hammer, tap the cap to loosen it and remove the cap.
5. Replace the bearing shells as outlined under 8, 9 and 10 above.
6. Reassemble the oil pan to the engine. See "Oil Pan."

### COOLING SYSTEM

Perhaps the best method for care of the cooling system is to clean and flush the system periodically. Also, use some good rust and corrosion preventive between cleaning periods. Almost all natural water contains some mineral salts which stimulate corrosion.

Exhaust gas leakage between the cylinder head and gasket also results in corrosion if exhaust gases discharge into the water, combining to form a variety of acids, such as carbonic, nitrous and sulphurous, all supporting electrolytic corrosion. It is, therefore, important that the cylinder head stud nuts be drawn down at regular and frequent intervals to prevent exhaust gases from leaking into the water jacket.

Air leaks around the hose connections and through the water pump should be carefully guarded against, since oxygen is a major factor in promoting corrosion. Check the hose connections frequently for air leaks.

# HERCULES MOTORS CORPORATION

If the engine or unit is equipped with a pressure type sealed system, it is imperative that the correct type radiator cap be used. This is determined by the type of system used.

There are two types of sealed cooling systems which are used extensively. One type has a safety relief valve arrangement built into the radiator filler cap, Illustration No. 16. The overflow pipe is also connected to the radiator filler neck above the lower seat of the pressure cap. In this manner, if excessive pressure develops in the cooling system, the lower part of the pressure cap will raise from its seat and allow the vapor to escape through the overflow pipe.

This type of cap should never be removed quickly. Always turn the cap off slowly until the pressure has escaped through the overflow pipe, then remove the cap.

The second type of pressure sealed cooling system has the pressure relief valve and overflow pipe built into the top tank as a separate unit (not connected to the filler neck).

However, if any type of sealed cooling system is used, the proper filler cap, good gaskets and a smooth gasket surface are essential if excessive loss of coolant is to be prevented.

From the above, it can readily be understood why serious overheating of the engine results when the incorrect filler cap, bad gaskets or a rough surface are encountered.

Use a good commercial neutralizer in the cooling system—one purchased from a reputable company. To obtain the best results, follow the instructions of the manufacturer.

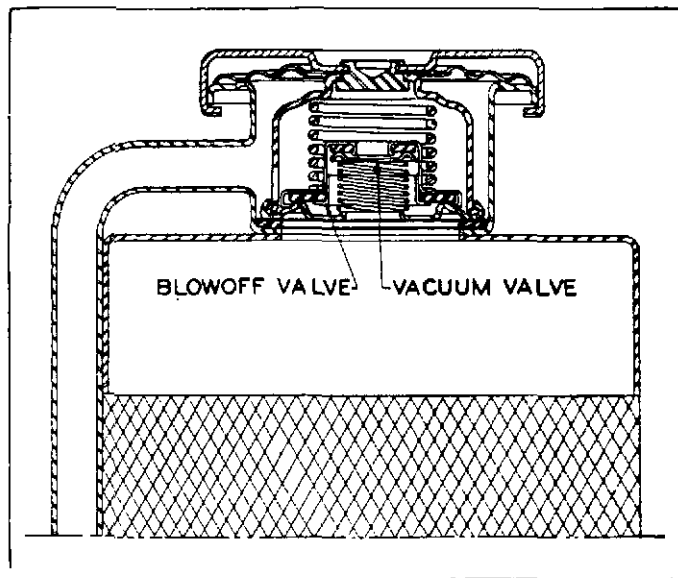

Illustration No. 16

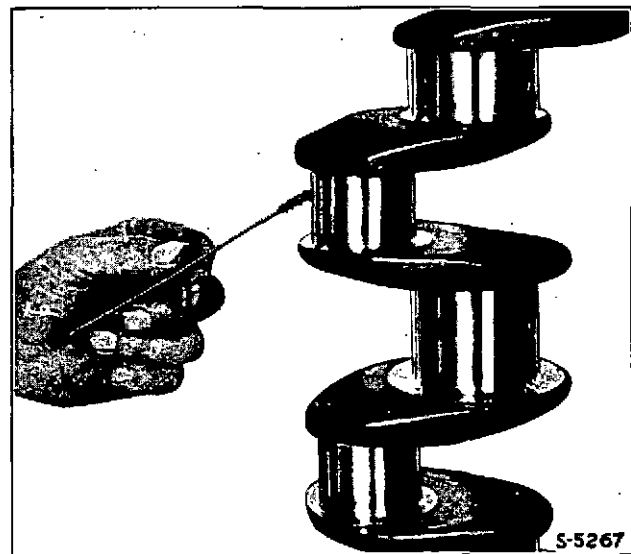

Illustration No. 17

## CRANKSHAFT

The crankshaft is a machined forging having all bearing journals surface-hardened. The nominal diameter of the main bearings is 2½" while the nominal diameter of the connecting rod journals is 2". The shaft has passages drilled to carry oil, under pressure, to the connecting rod bearings. These passages should be cleaned with a wire brush, see Illustration No. 17, before the shaft is installed in the engine.

While the diameters given above are only nominal, the following table gives the actual sizes, both standard and undersize, to which the shaft may be reground.

**WARNING!** When regrinding a crankshaft, it is imperative that the original radius from journal to cheek be maintained. Crankshaft breakage may result from improper grinding of this fillet.

### STANDARD CRANKSHAFT

Size	Main	Connecting Rod
Standard	2.4975/2.4965"	1.988/1.987"
.020" U. S.	2.4775/2.4765"	1.968/1.967"
.040" U. S.	2.4575/2.4565"	1.948/1.947"
.060" U. S.	2.4375/2.4365"	1.928/1.927"

### HEAVY DUTY CRANKSHAFT

Size	Main	Connecting Rod
Standard	2.8744/2.8734"	2.4986/2.4976"
.020" U. S.	2.8544/2.8534"	2.4786/2.4776"
.040" U. S.	2.8344/2.8334"	2.4586/2.4576"
.060" U. S.	2.8144/2.8134"	2.4386/2.4376"

## DESCRIPTION AND MAINTENANCE

To replace crankshaft main bearings, see "Main Bearings." To replace crankshaft connecting rod bearings, see "Connecting Rod."

### TO REMOVE THE CRANKSHAFT GEAR

If a suitable arbor press is not available, the following method may be used: Due to the extremely tight fit of the crankshaft gear on the crankshaft, it is almost impossible to pull this gear with any of the commercial pullers. Since replacement of this gear would only be brought about by the gear being badly worn or damaged, it may be removed in the following manner: Using a  $\frac{1}{4}$ " diameter drill centered midway between the edge of the keyway and the base of the gear teeth, drill through the gear parallel with the keyway, then spread the gear with a chisel and pull from the shaft. **CAUTION:** Be careful not to drill into the crankshaft.

### TO INSTALL A NEW GEAR

1. Insert the Woodruff key in the shaft.
2. Lay the gear on a sheet of asbestos or other fireproof material and heat the gear with a blowtorch evenly on both sides until the gear turns a pale straw yellow. (If the gear is clean and untarnished, this color will indicate it is heated to approximately 450° F.)
3. Assemble the hot gear on the crankshaft and, with a suitable driver, quickly force the gear into correct position. A piece of 2" diameter pipe may be used as a driver.
4. Allow the gear and shaft to cool.

## CYLINDER AND CRANKCASE

The cylinders are cast integral with the crankcase and have the water jacket carried the full length of the cylinders. This results in uniform cooling of the piston and cylinder wall and has a very definite bearing upon maintenance of lower oil temperatures than is possible with any other type of construction without the use of an oil cooler.

Material is cast iron with forged bearing caps fastened to the crankcase with  $\frac{1}{2}$ " and  $\frac{7}{16}$ " cap screws. The most casual inspection of the cylinder block will disclose the very rigid construction provided to support the crankshaft and this rigidity, coupled with the large diameter of the crankshaft, results in a very rugged and smooth running engine.

Some engines are equipped with dry, removable cylinder sleeves. See "Cylinder Sleeve." Those not equipped with cylinder sleeves may be rebored up to .060" oversize.

The cylinder block has a drilled passageway running the length of the block, which is closed on the ends with suitable pipe plugs, known as an oil header. From this header, various passages are drilled to carry oil to the main bearings, camshaft bearings and rocker arms. The passageway for the rocker arms is open at the camshaft thrust flange screw on the rear of the block, and this screw hole (A), Illustration No. 7, must be plugged to prevent oil leakage.

All oil passages should be thoroughly cleaned with a wire brush and solvent at overhaul time.

To replace main bearings, see "Main Bearings."

Core openings are closed by expansion type brass or steel plugs. If any of these should leak, remove and replace with new plugs.

### CYLINDER HEAD

The cylinder head is a one piece casting and is detachable. The valve seats are a part of this casting while the valve guides are removable bushings. The head is held to the cylinder block by studs and screws; and, in order to insure against leaks, the head must be carefully drawn down by means of the stud nuts and screws which should be progressively tightened, working from the center of the head toward the ends, as shown in Illustration No. 18.

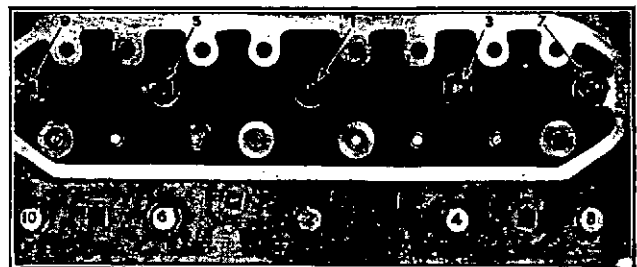

Illustration No. 18

## HERCULES MOTORS CORPORATION

A torque wrench is recommended for this operation. See "**Wrench Tension**" for recommended tensions. If a torque wrench is not available, a wrench approximately 18" long should be used for this operation.

If cylinder head gasket failure is encountered, a thorough check should be made of contributing factors. Detonation, pre-ignition or spark knock (caused by ignition which is too far advanced) will cause a shock load in the combustion chamber which will damage cylinder head gaskets and, if allowed to continue, may destroy the pistons and piston rings. Fuel with an octane rating too low may also contribute to detonation and corrosion of the gasket to the point where it will start leaking. Cooling solutions which are contaminated by corrosive combination gases leaking into the cooling system are very detrimental to the internal parts of the entire cooling system.

### TO REMOVE THE CYLINDER HEAD

1. Drain the radiator and remove the water thermostat housing and hoses. Also, disconnect the water temperature gauge thermocouple from the cylinder head.
2. Disconnect the exhaust pipe from the manifold.
3. Remove the manifold and carburetor from the cylinder head.
4. Remove the spark plug cables and spark plugs.
5. Remove the cylinder head cover, rocker arm assemblies and push rods.
6. Remove the cylinder head screws and nuts and lift the cylinder head from the engine. Tap the head lightly with a soft hammer, if necessary, to loosen it. Do not pry on the contact surfaces.

### TO REPLACE THE CYLINDER HEAD

1. Before installing the cylinder head, clean out the carbon deposits by scraping or brushing. If the valves are to be ground or otherwise serviced, see "**Valves.**"
2. Clean out the cap screw holes in the cylinder block, using a tap, if necessary.
3. Clean the cylinder block and cylinder head contact surfaces.
4. Install a clean, new cylinder head gasket on the cylinder block. The gasket must be assembled with the bead (rolled edge around the combustion chamber) down. No shellac or gasket cement is necessary.
5. Place the cylinder head and valve assembly on the block.
6. Start the head cap screws and nuts and tighten evenly, using a torque wrench. Start at the center of the head and work progressively to the outer ends, Illustration No. 18. See "**Wrench Tension.**"
7. Install the push rods and rocker arms.
8. Adjust the valve tappets to the proper clearance. See "**Valves.**"
9. Install the cylinder head cover, using a new gasket, if required.
10. Clean and adjust the point gap of the spark plugs; and, making sure the spark plug seats are clean, install the spark plugs in the cylinder head. See "**Spark Plugs.**"
11. Inspect the thermostat. See "**Thermostat.**"
12. Install the thermostat, housing and hoses. Connect the water temperature gauge thermocouple to the cylinder head.
13. Install the manifold and carburetor, using new gaskets, if required.
14. Connect the exhaust pipe to the manifold.
15. Fill the cooling system with the proper solution (water or anti-freeze).

### CYLINDER SLEEVES

When the engines are equipped with cylinder sleeves, they are fit to the cylinder block with a very light press fit and a sleeve puller should not be required to remove or install them. A block of wood or a suitable driver may be used to bump the sleeves out and, also, to install them.

These sleeves are precision machined to size before installation and no honing is necessary.

### FAN ASSEMBLY (Cooling)

The cooling fan is mounted on the water pump driven pulley, which is driven from a drive pulley mounted on the crankshaft by the use of one or more "vee" belts. Various accessories may be mounted on the engine and driven by these belts. Therefore, it is not possible to list the fan belt specifications.

### FLYWHEEL

Various flywheels used on the GO series engines are usually made of cast iron and may be machined to accommodate different types and sizes of clutches, as well as generators and other types of couplings. The flywheel is fastened to the crankshaft with four bolts and two dowels. One of these dowels is off center so that the flywheel can only be installed in one position. This properly locates the flywheel on the crankshaft for timing purposes. The timing mark, which indicates that No. 1 piston is on top center, may be seen (depending on the type of the bellhousing) through either a drilled hole provided in the bellhousing, Illustration No. 19, or as shown in Illustration No. 20. Some flywheels have a mark 2° before top dead center which is used to indicate ignition point opening when using a timing light, with the engine idling at 400 RPM.

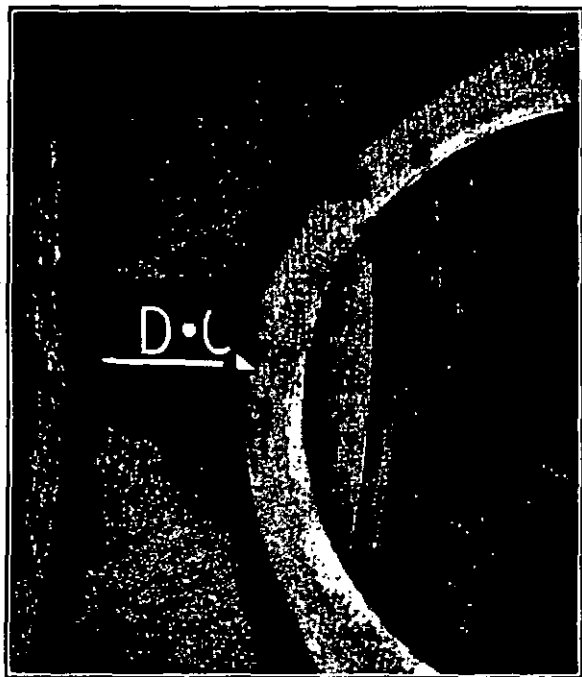

Illustration No. 19

#### TO REMOVE THE FLYWHEEL

1. Disconnect and remove the power take-off or transmission and clutch, whichever is used.
2. Remove the flywheel cotter pins or lock wires and remove the flywheel screws or nuts.
3. Using a Lady-Foot pry bar, pull the flywheel from the crankshaft.

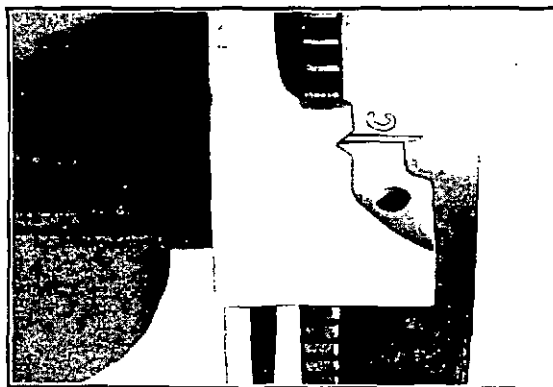

Illustration No. 20

#### TO INSTALL THE FLYWHEEL

1. Insert the flywheel dowels in the crankshaft and turn the crankshaft so that No. 1 cylinder is in top dead center position.
2. Turn the flywheel so that the timing mark is in line with the timing hole in the bellhousing. Then, install the flywheel on the crankshaft and draw in place with the flywheel attaching nuts or screws. Do not draw any one nut or screw tight until all are progressively tightened.

**NOTE:**—Some flywheels have the dowel holes machined so that they are blind holes while others have the holes drilled through; expansion plugs are used to cover the dowels.

3. Attach the indicator, as shown in Illustration No. 21, to check the concentricity of the pilot bore. This should not exceed .005" total reading.

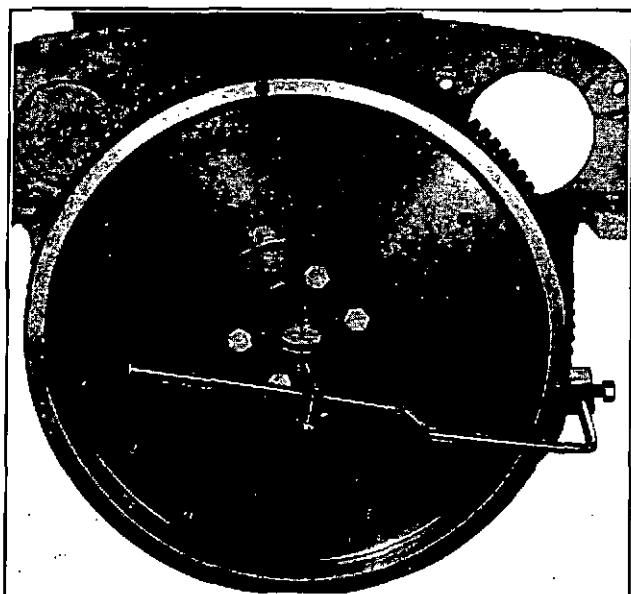

Illustration No. 21

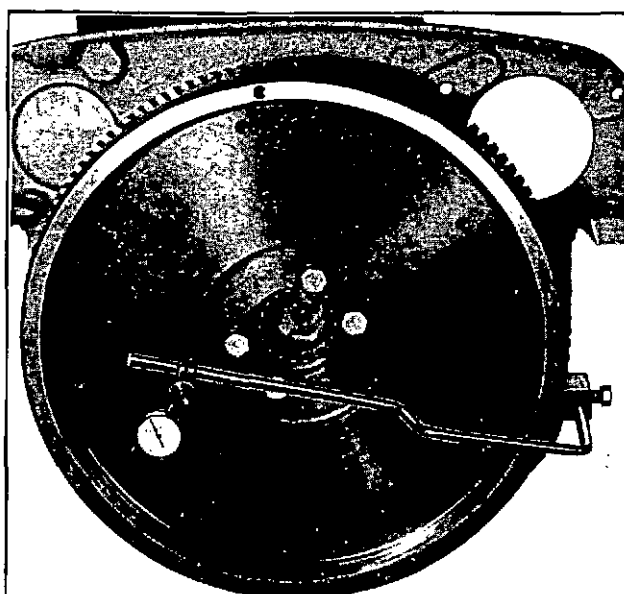

Illustration No. 22

4. Attach the indicator, as shown in Illustration No. 22, to check the face of the flywheel. This should not exceed .005" total reading.
5. Install the cotter pins or lock wires, as required; and insert the expansion plugs, if used.
6. Install the starting motor.
7. Install the clutch and transmission or power takeoff, as removed.

### FUEL PUMP

There are many different types of fuel pumps used on the GO series engines, most of which mount on a suitable pad provided on the cylinder block.

Fuel pumps commonly used are of the diaphragm type, operated by a rocker arm actuated from an eccentric on the camshaft, similar to the pump shown in Illustration No. 23.

In a great majority of cases, trouble attributed to the fuel pump is generally caused by failure in some other part of the fuel system; therefore, be sure that the trouble is actually in the fuel pump before removing it for inspection or repair. For instance, if the engine is not getting enough gasoline, check the level of the fuel in the fuel tank and check for broken, leaking or clogged fuel supply lines. Then, before removing the fuel pump from the engine, check for a leaking bowl gasket, loose diaphragm or top cover screws, or bad valves and springs. See Illustration No. 23.

If the engine is getting too much fuel, this is usually caused by a defective choke arrangement, punctured carburetor float, defective carburetor needle valve or improper carburetor adjustment; this is generally not caused by the fuel pump.

### TO REMOVE THE FUEL PUMP

1. Disconnect the fuel line from the tank and the fuel line to the carburetor and move out of the way.
2. Remove the two attaching screws which hold the pump to the crankcase and remove the pump from the crankcase, remembering that the rocker arm will catch on the case unless it is carefully pulled out of the small opening.

**NOTE:**—If the fuel pump is forced away from the crankcase by the spring tension on the rocker arm, this will indicate that the high point of the eccentric is toward the pump; and, in order to facilitate installation of the pump, the engine should be cranked over one full turn to place this high spot away from the fuel pump, opposite to that shown in Illustration No. 23.

## DESCRIPTION AND MAINTENANCE

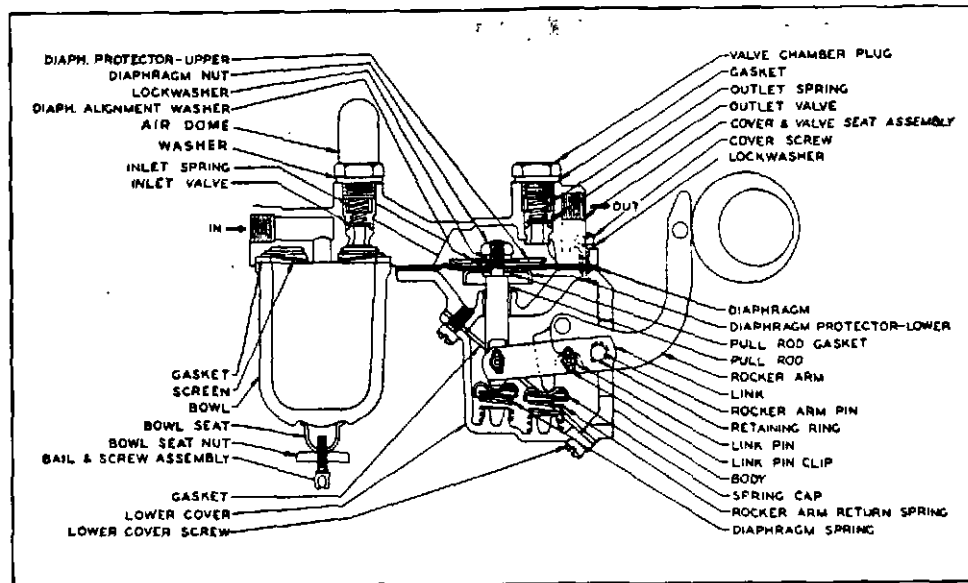

Illustration No. 23

### TO TEST THE FUEL PUMP

Before installing the fuel pump, it is always desirable to test it. This can be accomplished as follows:

1. Hook the fuel supply line from the tank to the pump inlet connection.
2. Holding the pump in the hand, work the rocker arm, using long, even strokes. After quite a few strokes, the bowl will fill with fuel; and, after it is filled, a few more strokes will force it through the pump and out the outlet side.
3. With strokes approximately  $\frac{1}{4}$ " to  $\frac{1}{2}$ " at the tip of the rocker arm, the pump should be able to deliver quite a bit of fuel. If it does not, with these short strokes, this would indicate that the pump requires servicing and should be taken to an authorized Service Station.

### TO INSTALL THE FUEL PUMP

1. Place a new gasket on the fuel pump.
2. Insert the rocker arm in the hole in the crankcase, being careful to keep the flange of the fuel pump in correct position while the two cap screws are started (some installations use studs and nuts).
3. A slight pressure will be exerted by the rocker arm springs while the screws are being pulled tight. However, if this pressure is excessive, remove the pump and turn the engine over one turn and endeavor to install the pump as outlined above. This light pressure can be noted, but it should not be excessively strong as to bend the rocker arm or prevent installation.
4. Connect the fuel lines.

## GEAR COVER

The gear cover consists of the cover and an adapter plate. The adapter plate is the front support for the engine and is doweled to the cylinder block. The cover plate covers the adapter, gears and governor, and in it the governor control shaft is mounted. The front oil seal for the crankshaft is also installed in the cover plate. This cover plate can be removed for inspection of the governor, and so forth, without removing the adapter, Illustration No. 24.

If necessary to remove this adapter, remove the camshaft as outline under "Camshaft," remove the two adapter attaching screws and pull the adapter forward away from the cylinder block. It may be necessary to tap the adapter with a soft hammer to loosen it from the dowels or gasket cement.

### TO REMOVE THE GEAR COVER

Assuming that the radiator has been removed, the gear cover may be removed as follows:

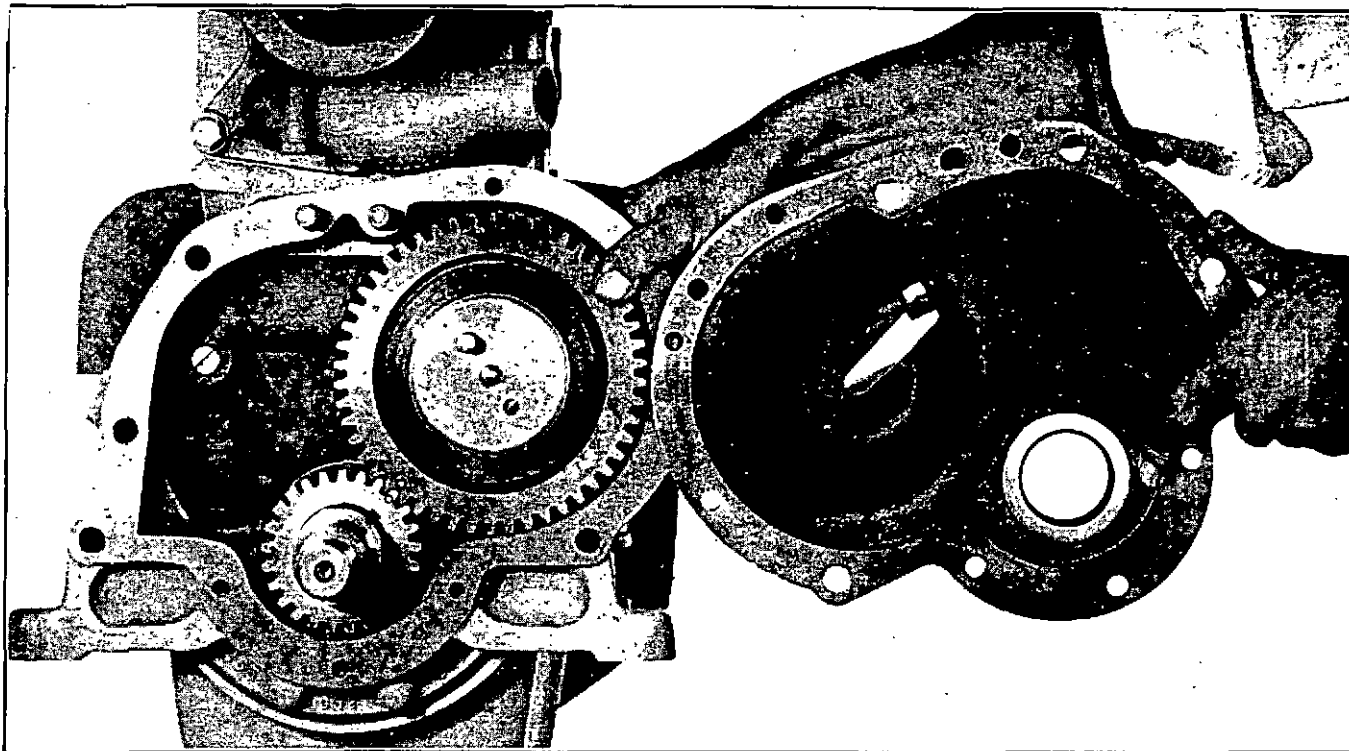

Illustration No. 24

1. Remove the fan blade and belt for easier access to the gear cover and gears.
2. Remove the crank grab nut and fan drive pulley.
3. Remove the governor linkage and spring, if used.
4. Remove the screws from the gear cover and pull the gear cover forward away from the engine.

**CAUTION:**—When removing the gear cover, it is best to move it forward slowly and, at the same time, hold the governor arm as far forward as possible until the hand can be inserted between the gear cover and the adapter in order to hold the outer governor race in place while the gear cover is being removed. Remove the outer governor race and balls until ready for inspection and reassembly.

5. The oil seal may be pressed from the gear cover, if replacement is necessary.
6. If the control shaft and parts bind or are worn so that replacement is necessary, remove the plug in the front of the gear cover and, using a small pin punch, remove the taper pin which holds the lever to the governor control shaft. Pull the shaft carefully from the cover. If the bearings are to be replaced, they may be removed by using a suitable driver. The outer lever should not be removed from the shaft unless it is damaged.

### INSPECTION

The various parts of the governor and control shaft should be carefully inspected for wear, possible cracks, binding, etc. Be sure that the camshaft gear retaining nut is tight and that the outer race support shaft moves freely in the camshaft. Replace any worn or damaged parts.

### TO REASSEMBLE THE GEAR COVER

1. If the governor control shaft and parts have been removed from the gear cover, they should be reassembled as follows:
  - a. Press the two shaft bearings and oil seal into the gear cover from their respective ends.
  - b. Check the control shaft to see that it is free of nicks and scores which might affect the seal or bearings. Remove the nicks by using Crocus or a fine polishing cloth. Insert the shaft in the gear cover.

## DESCRIPTION AND MAINTENANCE

- c. If a new shaft or lever is used, the outer control lever should be mounted, drilled, reamed and taper pinned (see NOTE) in its proper position before reassembly. The hole in the shaft for this outer lever is  $\frac{1}{2}$ " from the end.

**NOTE:**—Use a No. 32 drill and No. 00 taper reamer for the control shaft lever pin.

- d. After the shaft is in place in the cover, the inner lever is installed so that the holes in the shaft and lever align properly. Then drill, ream and taper pin this lever (see NOTE) to the shaft from the inner side of the gear cover. Install the plug in the gear cover.
- e. Check the shaft lever assembly to see that it has full travel and is free of all friction or binding in the gear cover.
2. Press a new crankshaft oil seal in the gear cover and cement a new gasket in place, allowing sufficient time for it to dry so the gasket will not skid.
3. Insert the steel governor balls in their retainer and install the governor outer race (light cup grease, Illustration No. 25, should be applied to hold these parts in place during assembly).
4. Install the gear cover on the engine and secure with screws and nuts as removed.
5. Install the fan drive pulley and crank grab nut on the crankshaft.
6. Install the governor control rod and connect the operating spring, if used.
7. Install the fan blade and fan belt, using the screws and lock washers as removed. The fan belt should be tightened so that there is approximately 1" deflection when grasped midway between the fan and drive pulleys.
8. Install the radiator, together with any other disassembled parts, and fill the cooling system with the proper solution (water or anti-freeze).
9. Adjust the governor linkage. See "Governor."

### GENERATOR

A periodic inspection should be made of the charging circuit. The intervals between these checks will vary, depending upon the type of service. Dirt, dust and high speed operation are factors which will contribute to increased wear of the bearings, brushes, etc. Under normal conditions, an inspection of the generator should be made every 100 hours.

1. **Wiring**—A visual inspection should be made of all wiring to insure that there are no broken wires and that all connections are clean and tight. Special attention should be paid to the ground connections at the battery and generator.
2. **Commutator**—If the commutator is dirty or discolored, it can be cleaned by holding a piece of 00 sandpaper against it while turning the armature slowly. Blow the sand out of the generator after cleaning the commutator. If the commutator is rough or worn, the generator should be removed from the engine, the armature removed and the commutator turned down.

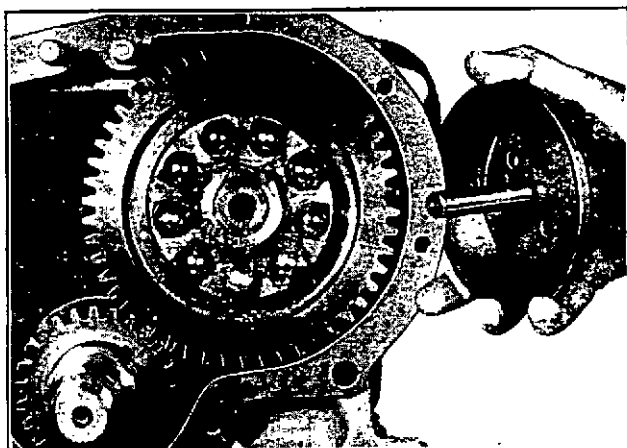

Illustration No. 25

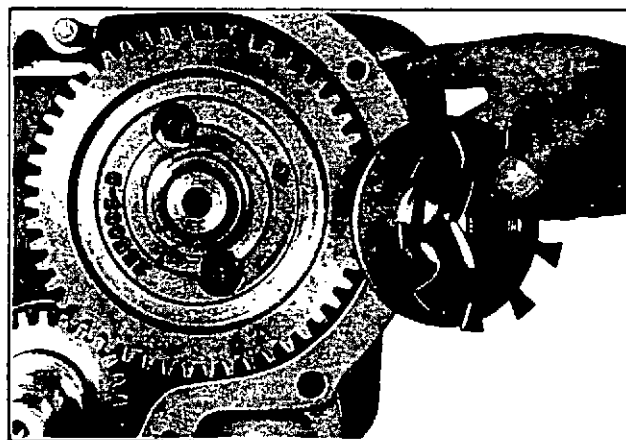

Illustration No. 26

3. **Brushes**—The brushes should slide freely in their holders. If the brushes are oil soaked or if they are worn to less than one-half their original length, they should be replaced.
4. **Lubrication**—Add 3 to 5 drops of medium engine oil to the oilers in the end heads every 100 hours of operation.

If the generator does not function properly after the above checks, the generator and the regulator or circuit breaker should be taken to an authorized service station for inspection and repairs.

### GOVERNOR

**NOTE: FOR EXTERNAL TYPE GOVERNOR SEE SUPPLEMENTAL PAGE NO. 64.**

The governor is a "fly-ball" type governor. The fly-balls control the speed of the engine, through suitable linkages, Illustration No. 27, connected to the carburetor, in the following manner:—When the engine speed drops, the centrifugal force of the fly-balls is less and this allows the governor to retract or open the throttle lever. As the speed increases, the fly-balls extend and, through the linkages, close the throttle.

Two basic principles of governing are used, depending upon the requirements.

1. **Constant speed control.** With this type, the engine operates at a predetermined speed setting of the governor spring so long as the load is within the limits of the engine.
2. **Variable speed control.** With this type, the operator changes the tension on the governor spring; and, since this increases or decreases the effective resistance on the governor, the engine speed is changed in direct relation to the change of the manual throttle control.

This governor requires no maintenance other than being sure that the linkage is free, with no loss of motion due to loose or worn connections. However, should it become necessary to remove the governor, proceed as follows:

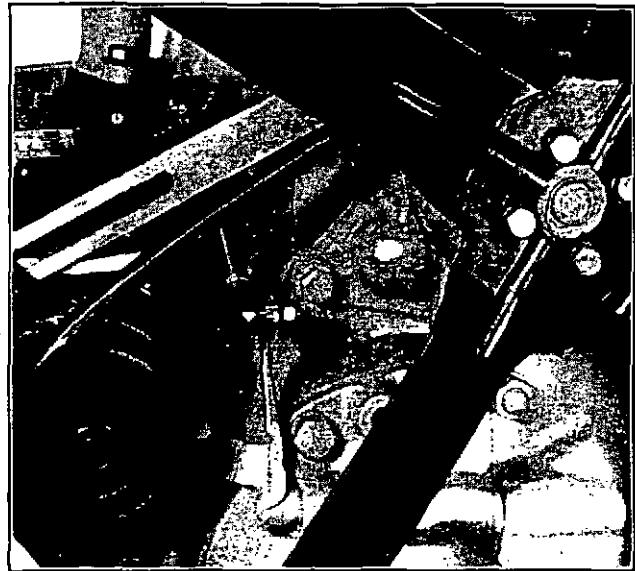

Illustration No. 27

#### TO REMOVE THE GOVERNOR

1. Remove the governor as outlined under "Gear Cover."
2. If it is necessary to remove the ball retainer or the rear race, remove the nut from the camshaft and pull these parts forward from the camshaft, Illustration No. 26.

#### TO INSTALL THE GOVERNOR

1. Place the rear race on the camshaft gear and the retainer on the end of the camshaft. Then, install the camshaft nut and tighten to 130 ft. lbs. torque. Check the rear race to see that it rotates freely on the camshaft gear hub and has end thrust of .007" to .020" clearance.
2. Assemble the balance of the governor as outlined under "Gear Cover."

#### TO ADJUST THE GOVERNOR

1. Start the engine and warm up to operating temperature.

**IMPORTANT:**—Never attempt to make governor, carburetor or ignition adjustments unless the engine is at operating temperature.

2. Stop the engine.
3. With the engine at rest, adjust the length of the rod between the governor and the carburetor so that, with the governor lever in full load position, the carburetor throttle lever is just off the full speed stop. Next, move the governor lever to no load position. The carburetor lever should now be at the idle position. Secure the rod adjustments in this position.
4. Start the engine and check the engine speeds. Adjust the throttle linkage (not the governor rod), if necessary, to obtain the specified engine speed.

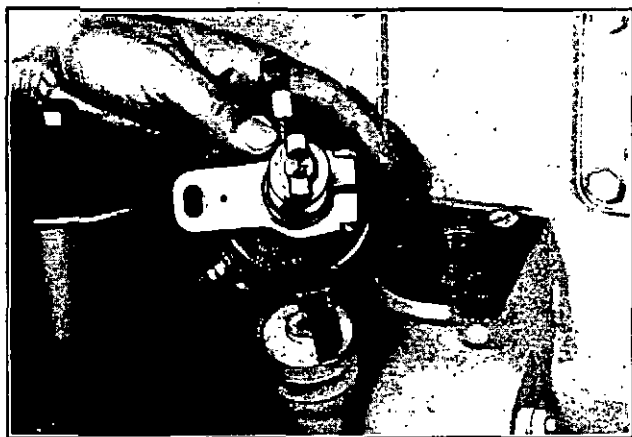

Illustration No. 28

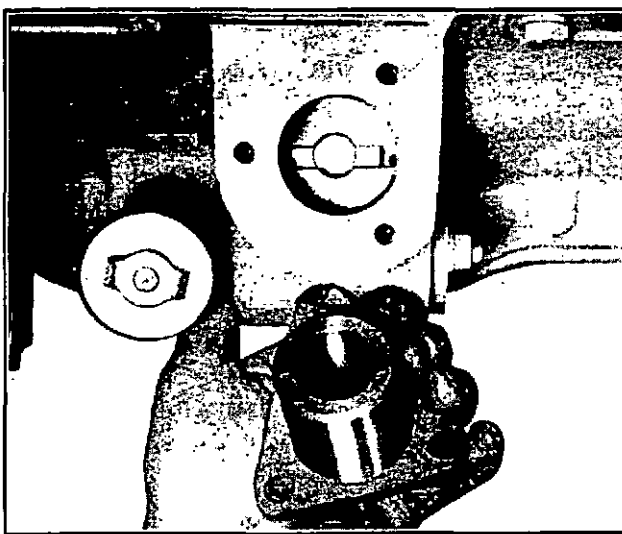

Illustration No. 29

### IGNITION TIMING (Battery)

The distributor (or magneto, if used) is driven from the oil pump gear through a tongue and groove type coupling. The tongue and groove of the coupling parts are slightly off center to prevent incorrect installation of the distributor, as can be seen in Illustration No. 28. The tongue and groove are offset away from the camshaft when the engine is properly spotted at No. 1 cylinder firing position, Illustration No. 29, and the distributor rotor is spotted at the No. 1 tower of the distributor cap, Illustration No. 30.

Should it be necessary to install a new coupling or distributor, it is necessary to turn the rotor to No. 1 cylinder firing position, with the primary terminal away from the engine. Then install the coupling at right angles to the terminal, with the offset to the terminal side of the distributor, and space the coupling so that there is approximately .005" to .008" end clearance. Drill the shaft and install the coupling pin. Peen the pin to insure tightness.

**NOTE:**—Since the ignition system is usually not furnished by the Hercules Motors Corporation, the following is inserted here for general information only. Instructions for ignition timing will differ slightly with different makes of electrical equipment, and the following is in the nature of general instructions suitable for any type of battery ignition. If the distributor has been removed or for any reason it becomes necessary to check or reset the ignition timing, proceed as follows:

#### SPOTTING THE FLYWHEEL

The first step in setting or checking the ignition timing is to locate the "DC" mark on the flywheel and line it up with the mark on the bellhousing, see "Flywheel." To determine whether the engine is in firing position for No. 1 cylinder, the engine can be cranked with the spark plugs removed to determine the compression stroke of No. 1 cylinder or the cylinder head cover can be removed and the position of the valves noted. If both rocker arms for No. 1 cylinder are clear, indicating that the valves are closed, and the exhaust valve on No. 4 cylinder (or No. 6 cylinder on a six cylinder engine) is not completely closed, this will indicate approximate firing position for No. 1 cylinder.



Illustration No. 30

Turn the distributor rotor so that it is at approximately the No. 1 cylinder firing position on the cap and insert the distributor into the block and coupling Illustration No. 30.

With the ignition points clean and making a square contact and set to the proper gap opening of .018" to .020", and with the engine at rest, the points should just start to open  $\frac{3}{16}$ " after the top dead center mark on the flywheel. With the engine idling at 400 RPM, the distributor should be set 2° before top dead center. The automatic or manual advance, or combination of the two, whichever is employed, will then advance the spark to the proper position when the engine is running.

There are several methods of checking accurately the exact point of contact opening. One method is by using a test light which, if connected in series with the primary circuit (when the ignition switch is on), will be lighted when the ignition contacts are closed and not lighted when the contacts are open. To change the ignition timing, loosen the clamp screw holding the spark control arm to the distributor and turn the distributor until the correct timing is obtained; then, tighten the clamp screw. If the distributor is being retimed after having been removed, it is now necessary to see if the rotor lines up with the distributor cap segment connected to No. 1 cylinder and that the remaining ones are connected in the order 1-2-4-3 for a four cylinder engine and 1-5-3-6-2-4 for a six cylinder engine.

## MAIN BEARINGS

The use of seven main bearings in the six cylinder engine and five main bearings in the four cylinder engine permits a main bearing to be placed on each side of each connecting rod bearing, see Illustration No. 1. This construction helps to eliminate vibration at high speeds. The center main bearing cap is held in position by four alloy steel cap screws  $\frac{1}{2}$ " in diameter while the remaining ones are held in position by two alloy steel cap screws  $\frac{9}{16}$ " in diameter.

The main bearings are removable, precision, shell type and the upper shell is interchangeable with the lower shell for each bearing. No shims are used. Reconditioning of this type bearing is accomplished by replacing the shells. These precision type shells are completely finished before being put in place and no line reaming or scraping is required. This allows renewal of bearings to be easily accomplished. The shells each have a small ear or projection which fits into a recess, which allows the ear to rest against the adjoining case or cap to prevent the shell from rocking or rotating. The bearing metals commonly used in precision, shell type bearings are harder and have a higher melting point than ordinary babbitt metal, and this requires the use of a hardened crankshaft.

## FITTING OF BEARINGS

The bearings in these engines are readily accessible after the oil pan and oil pump are removed. The bearings should never be fitted so tight that they bind or drag, see "Clearance Table." A certain minimum clearance is required at all times to provide an adequate oil film between the shaft and bearing and insure a free running engine. The bearings in these engines are of ample proportion and the full pressure lubrication system employed will give long lasting bearings, provided they are properly installed.

Tightening of the main bearing cap screws requires some care to prevent too much strain on the parts. Special wrenches are on the market which enable the mechanic to measure the force of his pull when tightening such parts. The wrench tension values given under "Wrench Tension" show the correct amount of pull to use on various screws. No attempt should be made to refit these bearings by filing or grinding the caps, as this will ruin the caps so new shells cannot be installed.

## REPLACEMENT OF THE MAIN BEARINGS

It is not necessary to remove the engine from the unit to replace the main bearings unless, of course, the crankshaft is damaged or worn to the extent that it must be replaced.

The following outline may be used as a guide for replacing the bearings when the engine has not been removed from the unit.

1. Disconnect the battery cable at the battery, as a safety measure.
2. If the starter is mounted below the oil pan level and causes interference, disconnect the starter cable and wiring; then remove the starter.
3. Drain the crankcase oil.
4. Remove the oil pan. Remove the tachometer drive, if used.
5. Remove the oil pump.
6. Loosen all main bearing cap screws.

### SAVE YOUR BATTERIES

Do not turn engine with starter unnecessarily.  
Use hand turning crank whenever possible.

## DESCRIPTION AND MAINTENANCE

7. Remove one bearing cap at a time and make bearing replacement. To remove the upper shell, a small pin may be inserted in the crankshaft oil hole and the shaft rotated so that the pin will push the bearing out. The new bearing may be inserted in the same manner, see Illustration No. 31.

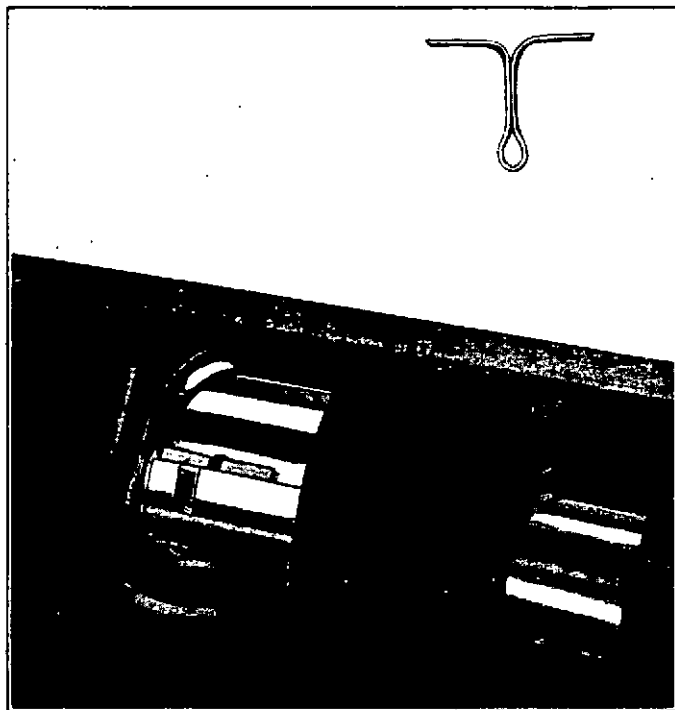

Illustration No. 31

**CAUTION:**—Be sure to remove the pin before assembling the bearing cap.

8. Assemble the bearing cap and lower shell and tighten the screws. See "Wrench Tension." If no torque wrench, Illustration No. 32, is available, use a wrench with an 18" handle.
  9. After installing new thrust bearings on the center main bearing, check the end thrust, Illustration No. 33. See "Clearance Table." It is permissible to draw file the thrust bearings to obtain the proper clearance, if necessary.
  10. Install the oil pump.
  11. Thoroughly recheck the inside of the engine for loose screws, nuts, etc.
  12. Install the oil pan.
  13. Install the starter.
  14. Connect the starter cables.
  15. Connect the battery cable.
  16. Fill the crankcase to the FULL mark on the bayonet gauge, see Illustration No. 6, with the proper grade of oil.
17. Start the engine and immediately check the oil pressure. See "Oil Pressure." If sufficient, allow the engine to run for a few minutes while checking for oil leaks, etc.; then, stop the engine and recheck the oil level. Add oil, if necessary.

### MANIFOLD (Intake and Exhaust)

There are various types of manifolds used on the GO four and GO six cylinder series engines; therefore, it is not practical to discuss them at length in this book. Manifolds differ as to the size of carburetor attaching flanges and the size of intake gallery. Also, the intake manifold ports may vary in size. Different exhaust outlets are used on different installations. Different manifolds are also manufactured for use with different types of fuel. From this list of differences, one can readily see the importance of replacing the manifold on the engine with the same type manifold unless the engine is to be applied to a different type of operation.

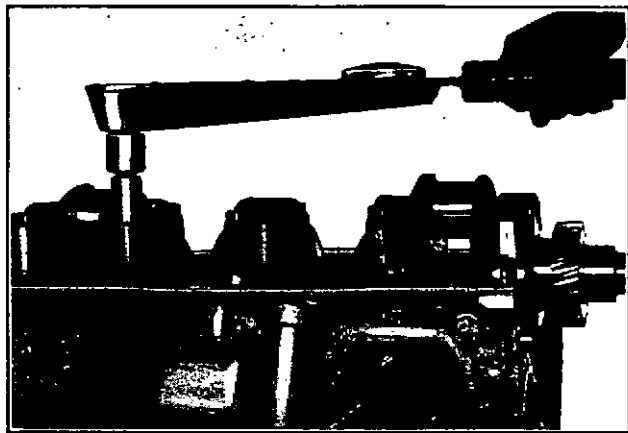

Illustration No. 32

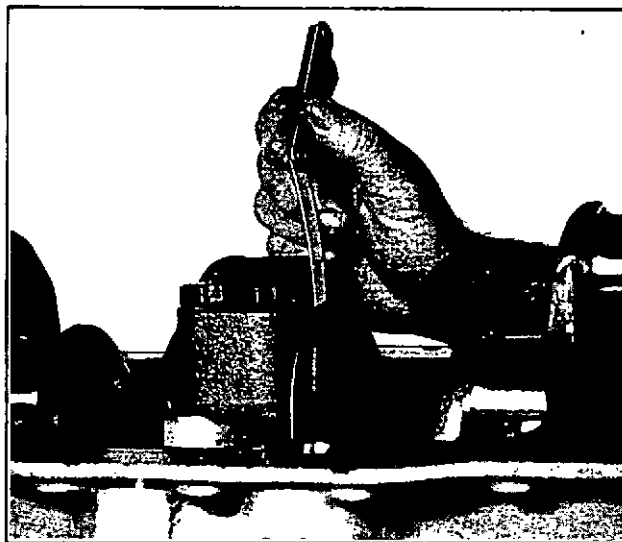

Illustration No. 33

## HERCULES MOTORS CORPORATION

---

In installing the manifolds, it is essential to use new gaskets and to be sure that the manifold intake and exhaust ports line up with those in the cylinder block. When tightening the manifold stud nuts, a washer should be used under the nut and the manifold tightened progressively from the center to the end, repeating the operation at least three or four times to make sure that the manifold is tight.

In many instances, a companion flange and gasket are used for the installation of the exhaust pipe. Be sure these are drawn up tight and square with the manifold flange to avoid leaks.

### TO REMOVE THE MANIFOLD

1. Disconnect the fuel lines.
2. Disconnect the carburetor controls. Carefully note how the controls are assembled so they can be replaced in the correct position.
3. Remove the air cleaner or air cleaner connections.
4. Remove the carburetor.
5. Disconnect the exhaust pipe from the manifold.
6. Remove the manifold attaching nuts and washers and remove the manifold.

### TO INSTALL THE MANIFOLD

1. Make sure all gasket surfaces are clean, place the manifold gasket on the attaching studs and assemble the manifold to the engine with the nuts and washers as removed.
2. Tighten the manifold into place. Tighten all nuts lightly; then, starting from the center, work progressively toward the ends of the manifold, repeating until all nuts are tight.
3. Attach the exhaust pipe and tighten the screws.
4. Connect the crankcase ventilation tube assembly.
5. Install the carburetor, using a new gasket.
6. Install the air cleaner or connect the air inlet tube.
7. Connect the carburetor controls. Make sure these controls are correctly assembled.
8. Connect the fuel lines.
9. After the engine has been operated a day or more, tighten all manifold and carburetor attaching nuts.

### OIL FILTER

The engines are usually equipped with an oil filter having a throwaway type element. Illustration No. 34. This filter should receive regular and careful attention. A definite schedule for replacement of the element can be determined from observation of the lubricating oil on the application in which the engine is used. In some applications, the period between changing the filter element may be very short while in others the change period may be extended considerably. Cold engine operation and long idling periods contribute to short filter element life.

When a new filter element is installed, add sufficient oil to the crankcase so the oil level will be correct after the engine has run long enough to refill the filter.

### OIL PAN

The oil pan serves as a cover for the bottom of the crankcase and, also, as an oil reservoir.

Suitable drain plugs are located in the bottom of the oil pan. See Illustration No. 35. The bayonet type oil gauge, used to measure the oil level in the pan, is covered under "Bayonet Gauge."

## DESCRIPTION AND MAINTENANCE

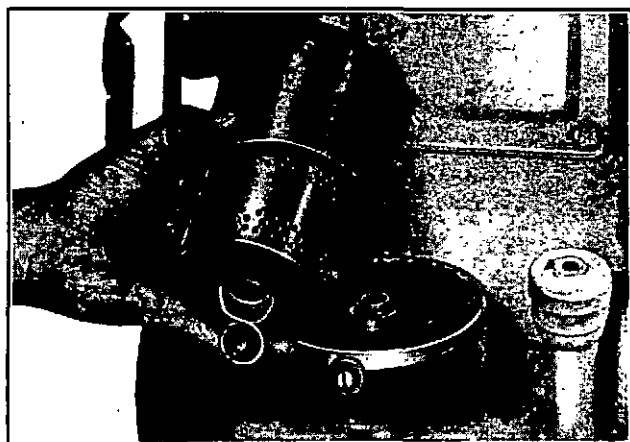

Illustration No. 34

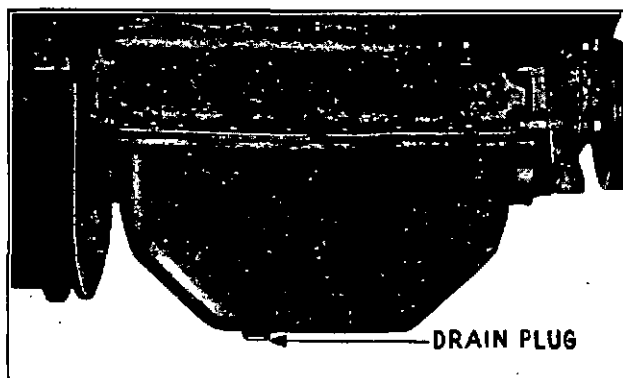

Illustration No. 35

### TO REMOVE THE OIL PAN

1. Drain the crankcase oil.
2. Disconnect the starter cable and remove the starter, if mounted below the center line. Tape any "hot" cable terminals.
3. Remove the bayonet gauge assembly.
4. Remove the cap screws from the oil pan and lift the oil pan away from the engine.

### TO INSTALL THE OIL PAN

1. Clean the oil pan thoroughly; also, remove the old gaskets from the oil pan and cylinder block.
2. Inspect the inside of the engine for loose nuts, screws, cotter pins, lock wires, etc.; tighten or replace.
3. Remove the front and rear oil pan adapters and clean the gasket surfaces.
4. Cement new oil pan side gaskets to the cylinder block.
5. Install the front and rear oil pan adapters.

**NOTE:**—If new bellhousing or gear housing gaskets have been used, it is necessary to cement the oil pan gaskets in place and install the adapters before tightening the bellhousing and timing gear housing attaching screws.

6. Cement the oil pan front and rear seals in the oil pan with Armstrong No. D-200 adhesive, if available. (Hercules part No. 255215-A) so that each end of the seal extends the same distance above the oil pan attaching flange. (**NOTE:** This adhesive sets quickly and seals should be inserted at once.) **Do not** cut off the ends of the seals.
7. Apply some lubricating oil to the oil pan adapter gasket surfaces, put the oil pan in place and carefully start all screws. Be sure the lock washers are on the screws.
8. Draw up all screws evenly and progressively. This will allow the oil pan to center on the adapter blocks.
9. Install the drain plug.
10. Install the starter motor and connect the cables:
11. Refill with oil to the correct level.
12. Reinstall the bayonet gauge assembly.

### OIL PRESSURE ADJUSTMENT

The oil pressure is automatically controlled or regulated by a compression type spring which controls a relief or bypass valve. This device is assembled to the oil pump. It controls the oil pressure through a predetermined spring pressure and, therefore, no adjustment of oil pressure is required. However, if the pressure regulator becomes sluggish in operation, due to dirt or sludge in the oil, it should be cleaned. This may be accomplished by removing the snap ring (A), Illustration No. 36, and then removing the spring retainer (B), spring (C) and valve (E) from the pressure regulator body (D), as shown in Illustration No. 37. These parts should be thoroughly washed and cleaned and reinstalled in the reverse order as removed.

The oil pressure regulator is calibrated to maintain a pressure of 30 to 45 pounds in the system. This will vary somewhat with the temperature of the oil and the SAE weight of the oil; also, with the engine speeds.

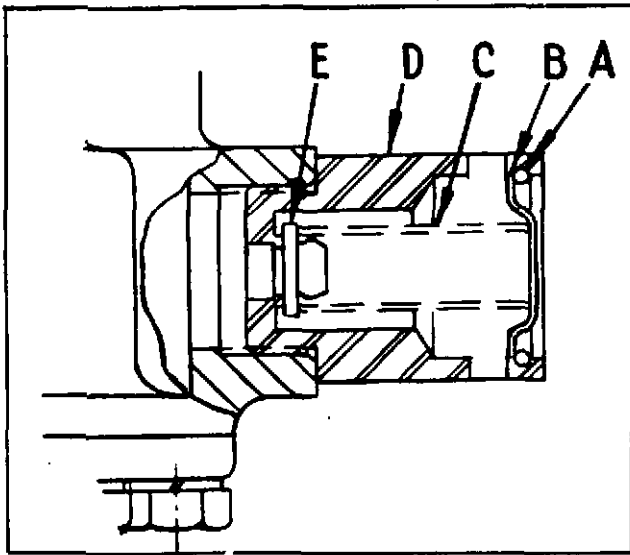

Illustration No. 36

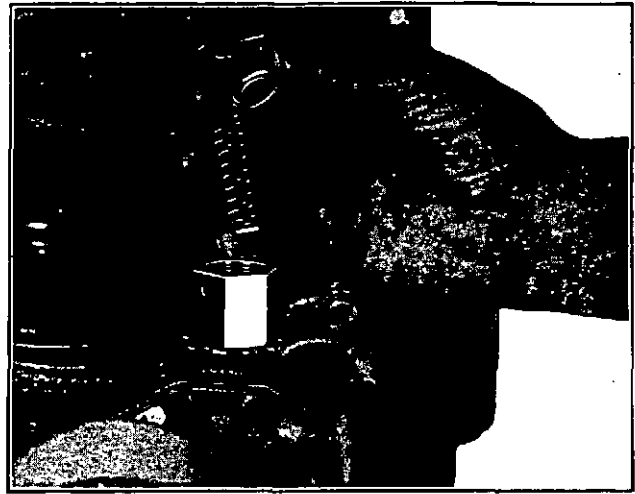

Illustration No. 37

### OIL PUMP

The oil pump is attached to the cylinder block with suitable screws and gasket and is driven by a gear solid with the camshaft and located near the center of the camshaft. The lower end of the oil pump extends down into the oil pan, and the oil is drawn into the pump through a large screen, which prevents coarse dirt from being drawn into the lubricating pump. The oil pump extends into the oil; therefore, the pump needs no priming. After the oil pan is removed, the oil pump is readily removed for inspection or repairs. The various parts of the oil pump are shown in Illustration No. 38.

#### TO REMOVE THE OIL PUMP

1. Remove the oil pan. See "Oil Pan."
2. Turn the engine so that No. 1 piston is in firing position. This may be noted from the position of the distributor rotor or from the position of the cams on the camshaft.

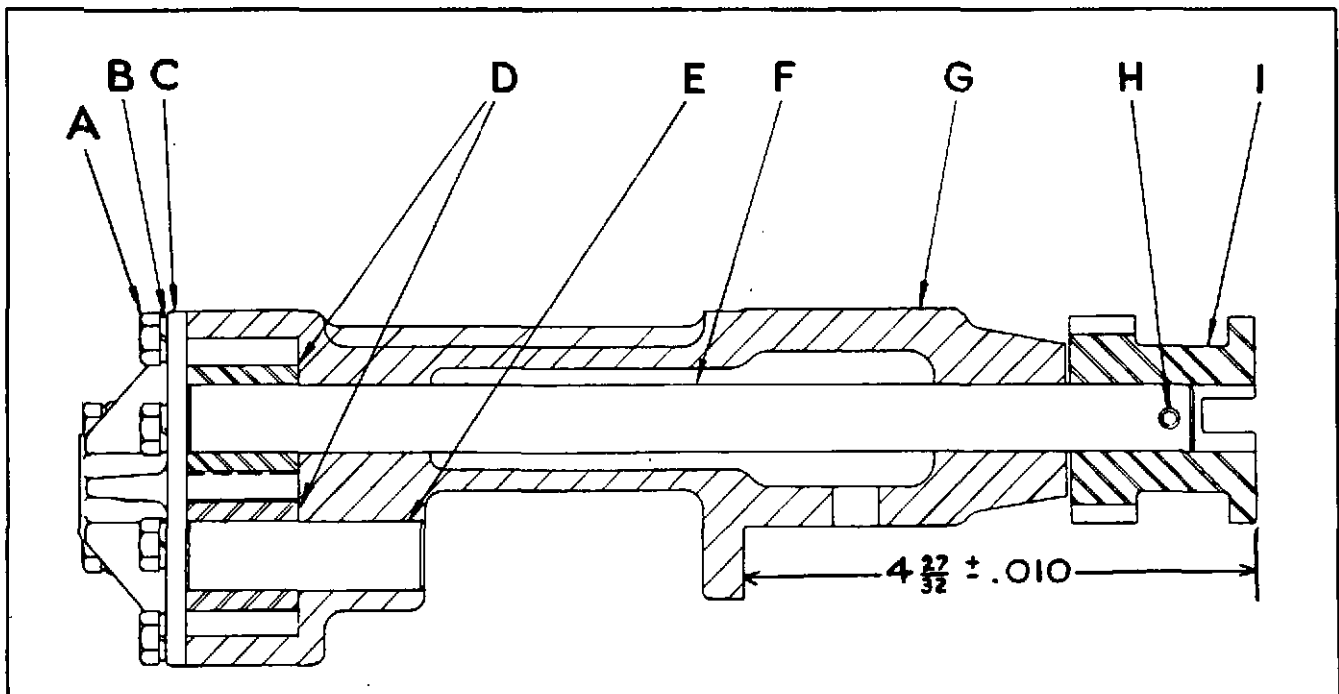

Illustration No. 38

## DESCRIPTION AND MAINTENANCE

**NOTE:**—If the engine is equipped with a tachometer drive, this must be removed before attempting to remove the oil pump.

3. Remove the screws from the oil pump attaching flange and pull the oil pump from the engine.

**NOTE:**—When the engine is equipped with a counterbalanced crankshaft, it is necessary to rotate the crankshaft and, at the same time, remove the oil pump with a spiral motion.

### TO DISASSEMBLE THE OIL PUMP

(Letters refer to Illustration No. 38 unless otherwise noted.)

1. Remove the drive gear pin (H) and pull the gear (I) from the shaft.

**NOTE:**—Puller must be under the gear and not under the distributor drive coupling flange.

2. Remove the screws (A) and washers (B) from the pump gear cover (C) and remove the cover.
3. Remove the gears (D) and shafts (E and F). The gears (D) may be pressed from their respective shafts, if necessary.

### TO REASSEMBLE THE OIL PUMP

1. Press the gears (D) on to their respective shafts (E and F).
2. Assemble the shaft (F) in the pump body; and, lining up the hole in the gear (I) with the shaft (F), press the gear on to the shaft. This gear should be pressed on to the shaft to the dimensions shown in Illustration No. 38.
3. Insert the drive gear pin.
4. Insert the idler gear shaft (E) and gear (D).
5. Install the cover (C) with the screws (A) and lock washers (B) as removed.
6. Turn the pump shaft to insure freeness of rotation. If the shaft binds or is otherwise tight, disassemble and ascertain the reason. Correct and reassemble the pump.

### TO INSTALL THE OIL PUMP

1. If the engine has been moved or rotated since removal of the oil pump, it is necessary to spot the engine with No. 1 cylinder in firing position. This may be noted from the position of the valves. See "Ignition Timing."
2. Turn the oil pump drive gear so that the flat on the flange, Illustration No. 39, is to the outside of the pump (the side opposite the pressure regulator).
3. With the flat towards the camshaft, insert the oil pump into the cylinder block and rotate the oil pump to the correct position for assembling the attaching screws.

**NOTE:**—The oil pump should not be rotated until after the drive gear is meshed with the gear of the camshaft.

**NOTE:**—When the engine is equipped with a counterbalanced crankshaft, proceed as outlined above except that, after the oil pump driven gear teeth have just been engaged in the camshaft gear, it is necessary to rotate the crankshaft and, at the same time, complete the insertion of the oil pump with a spiral motion.

4. Install the oil pump attaching screws.

If the distributor was not removed, care must be exercised that when the oil pump is installed the tongue of the distributor drive coupling properly engages in the groove in the oil pump drive gear, with the distributor rotor in firing position for No. 1 cylinder. If the distributor was removed, a visual inspection of the oil pump drive gear groove will show that it is parallel with the engine when the gear is properly timed, with the crankshaft spotted in No. 1 cylinder firing position.

5. Install the oil pan. See "Oil Pan."
6. Fill the crankcase to the proper level with the correct grade of lubricating oil.

## OIL SEAL

The construction of these engines prevents oil leakage when the gaskets are in proper condition and all bolts and screws are properly tightened. Whenever a shaft extends through the engine case and there is a possibility of oil leakage, an oil seal is used which also acts as a dust seal, preventing dust from entering the engine.

At the flywheel end of the crankshaft a patented type oil seal is used, Illustration No. 40. As can be seen in this illustration, the oil seal is mounted in the bellhousing so that it seals against the flange of the crankshaft.

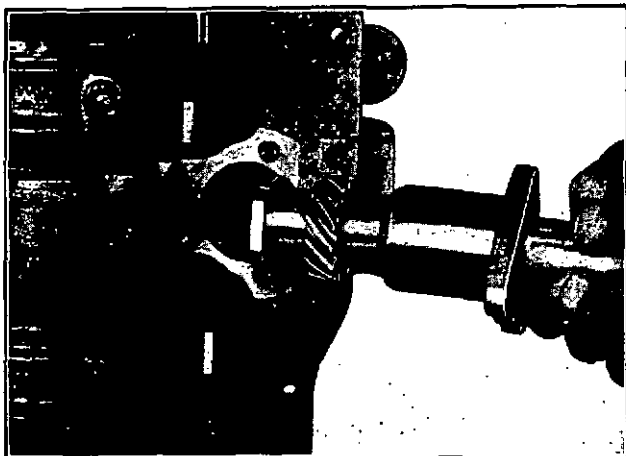

Illustration No. 39

The crankshaft is also prevented from leaking, at the timing gear end, by the use of the same type of seal. This seal is pressed into the gear cover; also, in the gear cover is the seal which prevents oil leaking at the governor control shaft.

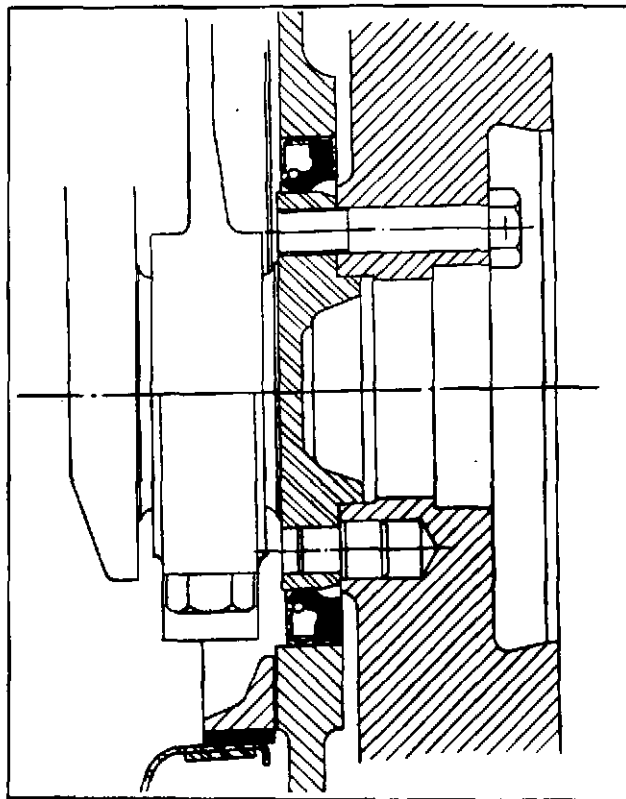

Illustration No. 40

This type of seal requires very little attention; however, at assembly the shaft seal surfaces on which the seal rides must be thoroughly and carefully checked for nicks or scratches which may have a tendency to damage the seal. If any nicks or scratches are found, they should be removed with an oil stone or very fine emery cloth and polished with Crocus cloth. If the shafts have a keyway which might damage the seal during installation, this keyway should be covered with a thin feeler gauge to protect the seal.

No special tools are required to install the seals on the shafts, since the shafts are tapered to allow the seals to easily slip into place. However, a certain amount of care is required in order not to damage the seals. A coating of oil soap on the seal surfaces of the shafts and, also, on the seals themselves will be found beneficial during the run-in period.

## PISTON

The piston is made of an aluminum alloy and is of the solid type, having no saw slots or split in the skirt. Four piston rings are used—the upper two rings being of the compression type while the third ring from the top, which is above the piston pin, and, likewise, the ring located near the bottom of the skirt are of the oil regulating type. The top of the piston is made thick in order to uniformly transfer the heat from the top of the piston to the various rings and to the skirt of the piston, where it can be dissipated into the water jacket without any of the piston rings becoming extremely hot, which condition tends to rapidly destroy lubrication of such parts.

When checking the piston rings, consideration must be given to the fact that the rings are not as tight in the grooves when the piston is hot; and, consequently, rings which seem to be tight in the grooves after the engine has been in operation for a considerable period of time may, in reality, be loose enough to function properly when the engine is heated up. The appearance of the contact surface of the rings will usually show whether the rings have been functioning properly.

The pistons should be fitted to the cylinder bores with the proper clearance. See "Clearance Table." If a feeler ribbon is used, this should be a ribbon of  $\frac{1}{32}$ " wide and of the thickness indicated in the Clearance Table. A scale should be used to obtain the pull indicated in the Clearance Table.

To remove or install the pistons, see "Connecting Rod."

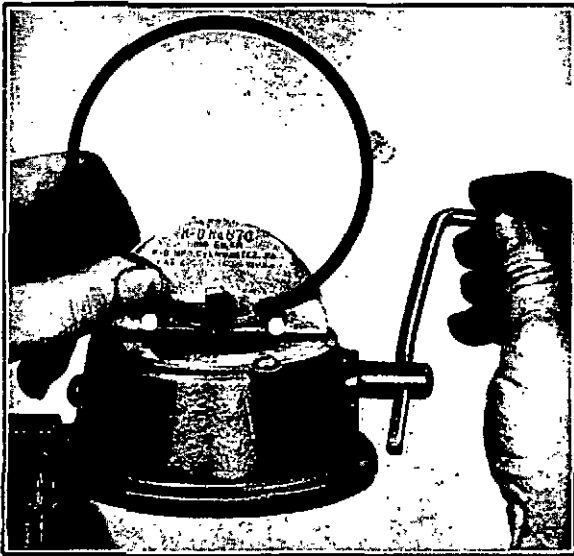

Illustration No. 41



Illustration No. 42

### PISTON PIN

The piston pin is a large diameter pin of the full floating type. This means that the pin can rotate in either the piston bosses or in the bushing at the top end of the connecting rod. But, the fit in the piston is intended to be much tighter than the fit in the connecting rod; consequently, the movement in the piston consists of a light, creeping action while the normal rotation of the pin occurs in the bushing at the top end of the connecting rod. The piston pin is prevented from moving endwise and making contact with the cylinder wall by means of snap rings, which locate in grooves machined in the bosses of the piston. Piston pins should be fit in the piston bosses with the proper clearance, as indicated in the Clearance Table.

### PISTON RINGS

The piston rings, when fitted in the cylinder bore of the engine, should have a gap clearance between .015" and .020". The piston ring land clearance is indicated in the Clearance Table.

When installing new piston rings, each ring should be tried in the cylinder bore to see if it has the correct gap of .015" to .020". If necessary to increase the gap, the ring should be held and filed as shown in Illustration No. 41. If the ring is held in a vise, the vise jaws must be covered with some soft metal. The ends of the rings are squeezed together and the file cuts on both sides. This will insure the ends being parallel. When inserting the ring in the cylinder bore to test the gap clearance, push the ring part way through the bore, using the bottom of a piston to square the ring in the bore.

Each new ring should be tried for clearance in the piston groove by rolling the ring all the way around the groove, as shown in Illustration No. 42. If the piston grooves have been carefully cleaned, the rings will be found to fit correctly; but, if they are tight, they can be lapped slightly on a sheet of emery cloth (No. 000) laid on a flat surface. Use a light uniform pressure when lapping.

When assembling the piston rings to the piston, if ring spreader tool, Illustration No. 43, is not available, the rings can be slipped over thin strips of metal. Whatever method is used, the rings must be handled carefully in order not to distort or break them.

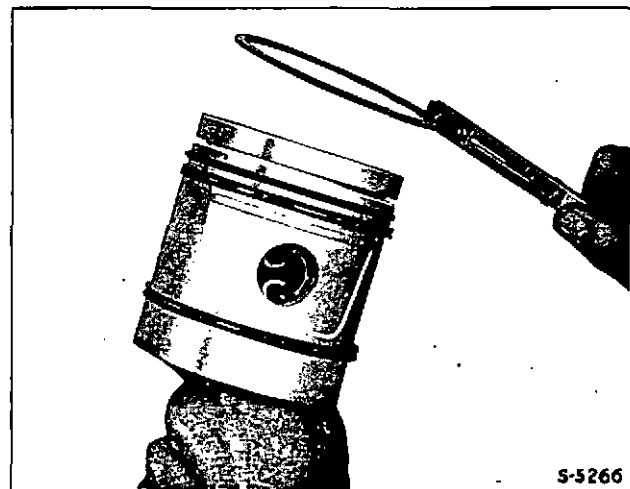

Illustration No. 43

S-5266

## SPARK PLUGS

Spark plug performance has a very important part in engine operation and economy. Therefore, it is important that the correct type of spark plug be selected for your particular engine operation.

Spark plugs are made in various types and each type has a definite purpose, which depends on the service required of the engine. For instance, one engine may be operated continually at, or near, full load and would require a colder type spark plug while another engine of the same type, which is operated at part load or with long periods of idling, would require a hot type spark plug. See Illustration No. 44.

Illustration No. 44 shows a comparison of spark plug types. The cold plug has a low insulator seat, which quickly carries the heat away from the insulator and keeps the spark plug insulator and points cooler. This results in longer plug life when the engine is in operation for long periods at full loads.

The normal plug has a higher insulator seat, which allows the insulator to retain a normal amount of heat. This type of plug should be used when the engine is operated at intermediate and variable loads and speeds.

The hot plug has a very high insulator seat, which permits the core to retain the maximum amount of heat. This type of spark plug should be used when the engine is operated at part load with intermittent periods of idling.

**Spark plug maintenance is very simple and easily accomplished and should not be neglected.**

After removal of the ignition wires, select the correct size socket wrench and loosen each plug approximately two turns. Then, with compressed air or a brush, clean the dirt from around the spark plug. This is important as the dirt may fall into the cylinders and cause damage when the engine is started.

When the dirt has been removed from around the plugs, remove the plugs from the engine and carefully examine the condition of the points and insulator.

A careful study of the following illustrations and text will explain various spark plug conditions, as well as probable causes.

Illustration No. 45 shows the normal condition of a plug that has been carefully selected for a particular type of service. Notice the dry, light to dark brown, flaky deposits of combustion products which, when exhibited on each spark plug of a set, indicate a balanced ignition and combustion condition.

Illustration No. 46 shows a burned or overheated spark plug. These are usually identified by dry, shiny, glassy deposits on the insulator, or cracks in the insulator tip, which result from:

1. Too lean an air-fuel mixture.
2. Dirty, clogged radiator or cylinder block and head (or inefficient engine cooling).
3. Broken or slipping fan belt.
4. Too hot a spark plug for the service.
5. Improper installation of the spark plugs.
6. Compression leakage through the spark plug.

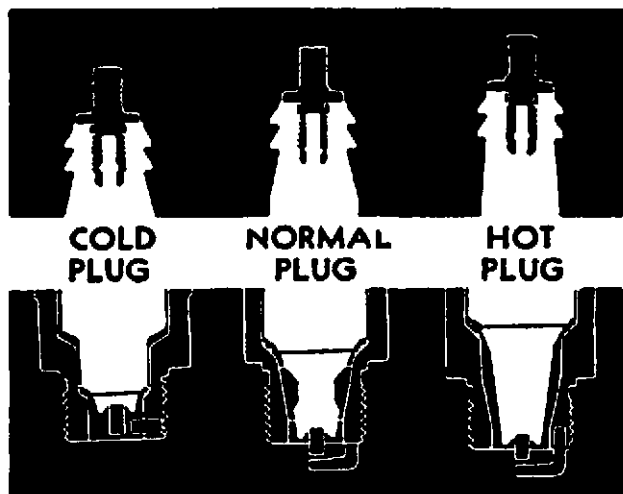

Illustration No. 44

Illustration No. 47 shows a gas fouled spark plug. This condition is usually identified by a black, dry, fluffy deposit which results from:

1. Heat range of spark plug too cold for particular service.
2. Prolonged periods of engine idling.
3. Excessive use of the choke or improper adjustment of the automatic choke.
4. Too rich an air-fuel mixture.
5. Worn piston rings or pistons.

## DESCRIPTION AND MAINTENANCE

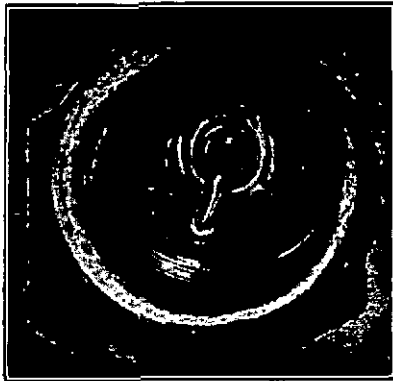

Illustration No. 45

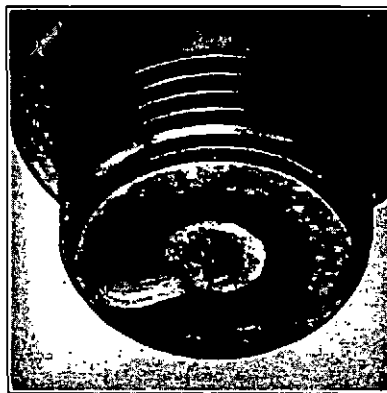

Illustration No. 46

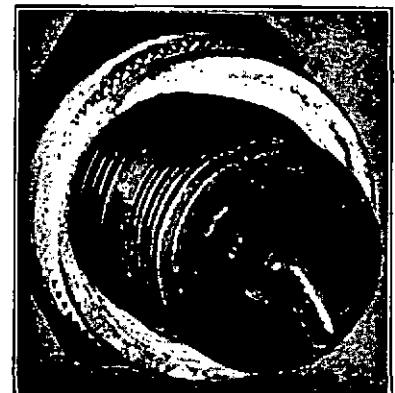

Illustration No. 47

Illustration No. 48 shows an oil fouled plug. This condition is usually identified by the wet, black shiny deposit. This may be caused by:

1. Heat range of spark too cold for particular type of service.
2. Distributor trouble or faulty ignition cables.
3. Weak coil or battery.
4. Spark plug gaps too close.
5. Worn piston rings or pistons.

Illustration No. 49 shows how the spark plug points wear or corrode with service. The amount of wear indicates the extent of service to which the plug has been subjected. When the plugs become worn to this extent, they should be discarded and replaced.

Before reinstalling the spark plugs, they should be cleaned and have the point gap adjusted. Always adjust the points by bending the ground electrode. Never attempt to bend the center electrode as this may chip or crack the insulator and render the plug inoperative.

When installing spark plugs, be sure the spark plug seat is clean and use a new gasket, if available.

The plug is properly tightened when the gasket is compressed to approximately one-half its original thickness when new. If a spark plug is tightened too tight, the body may become distorted and crack the insulator. Spark plugs should be retightened after a few hours' operation.

If the plug is too loose, it may allow exhaust gases to escape around the threads and, at the same time the heat will not be carried away from the plug fast enough to prevent the plug from becoming damaged from excessive heat.

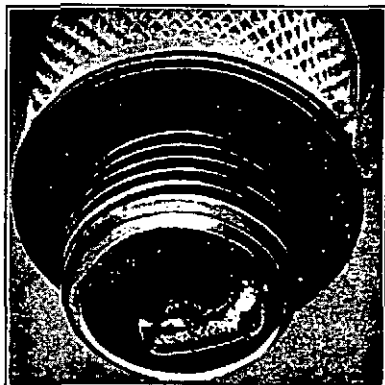

Illustration No. 48



Illustration No. 49

**STARTING MOTOR**

The starting motor is designed to crank the engine when the switch closes the circuit between the storage battery and the motor. It consists of five main sub-assemblies: the frame and field, the armature, the commutator end head, the pinion housing and the Bendix drive. The frame and field consist of the frame which supports the components of the starting motor, the pole pieces and the field coils. The coils supply the path for the magnetic field. Illustration No. 50 is an assembly drawing of a typical starting motor.

The armature consists of a soft iron core, a commutator and the windings which are wound in slots in the core and are connected to the commutator. The commutator consists of a number of copper segments insulated from each other and from the armature shaft.

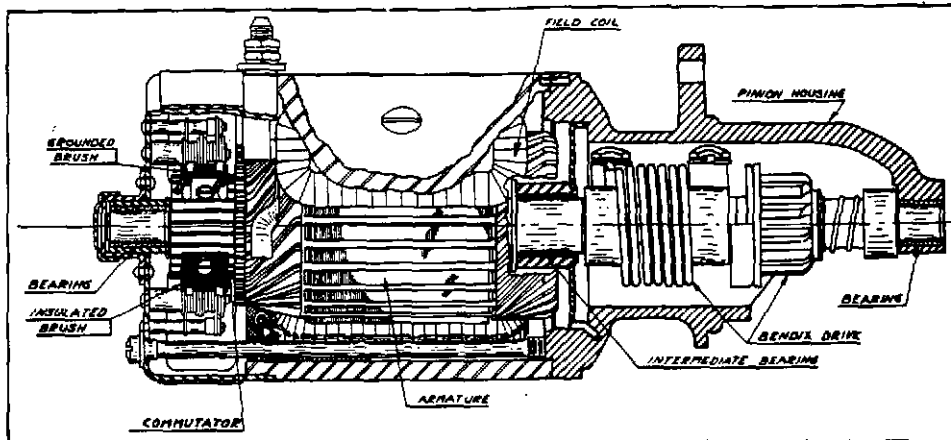

Illustration No. 50

The commutator end head supports a bearing, brush holders and brushes. The pinion housing is a cast iron housing for the Bendix drive and also provides the motor mounting lugs. The Bendix drive is an automatic clutch that engages the starting motor with the engine flywheel when the motor cranks the engine and disengages when the engine starts. It consists of a threaded sleeve fastened to the armature shaft thru a drive spring and a pinion mounted on the threads of the sleeve. When the starting circuit is closed the armature revolves, turning the sleeve within the pinion and forcing the gear forward, meshing it with the flywheel gear. The sudden shock of meshing is absorbed by the spring. When the engine starts the pinion is driven faster than the sleeve and is forced back along the threads, automatically de-meshing it from the flywheel.

**LUBRICATION**

Some starters are provided with an oil cup which should be filled with lubricating oil when the unit is lubricated.

Other starters have no provision for oiling; these are lubricated at the time of overhaul.

After the starting motor has been in service for an extended period it should be removed, dismantled and cleaned. Clean the Bendix drive thoroughly and lubricate sparingly with light oil. Inspect the wiring for loose or corroded connections and for broken leads. Make sure the insulation on the wiring has not become frayed.

**MINOR ADJUSTMENTS**

help to maintain the engine in good condition which alleviates major repairs and prolongs its usefulness.

## THERMOSTAT AND BYPASS

The engines are equipped with a thermostat, Illustration No. 51, so designed that it will not allow water from the radiator to circulate through the engine until the water in the engine is at operating temperature but does bypass a certain amount of water from the cylinder block, which is carried through the bypass tube to the inlet side of the water pump, where it is again circulated through the engine. This is repeated until the water in the engine is heated to operating temperature, when the thermostat begins to open and permits the water from the engine to enter the radiator. This water is, at the same time, replaced in the engine by the water pump drawing from the bottom of the radiator. Thus, the water temperature is constantly maintained in the proper heat range.

A defective thermostat of this type must be replaced as it cannot be repaired. Thermostats are usually marked with their normal operating temperature and may be tested by the still water test.

The still water test is as follows:

Place approximately 4" of water in a pan or pail. Insert a thermometer of this heat range in the water and set the thermostat in the water with the bellows submerged. Heat the water slowly and carefully observe when the thermostat valve starts to open. Note the water temperature as indicated by the thermometer; continue to heat the water until the thermometer is fully open and again note the water temperature. Then compare these temperatures with those given above.

Five degrees above or under those given are permissible.

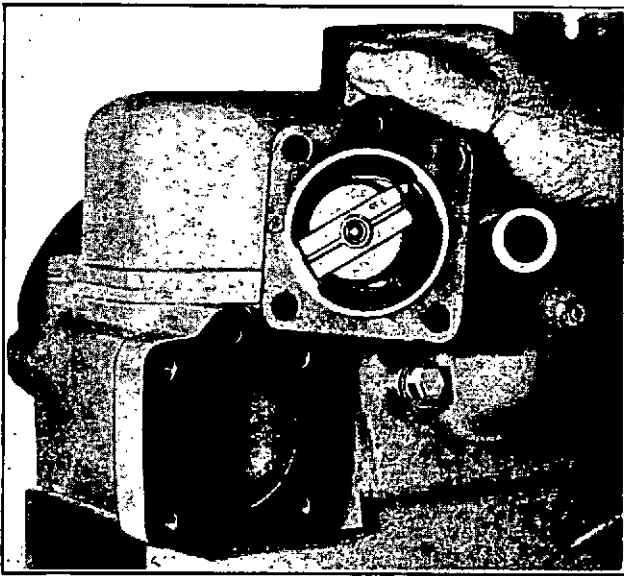

Illustration No. 51

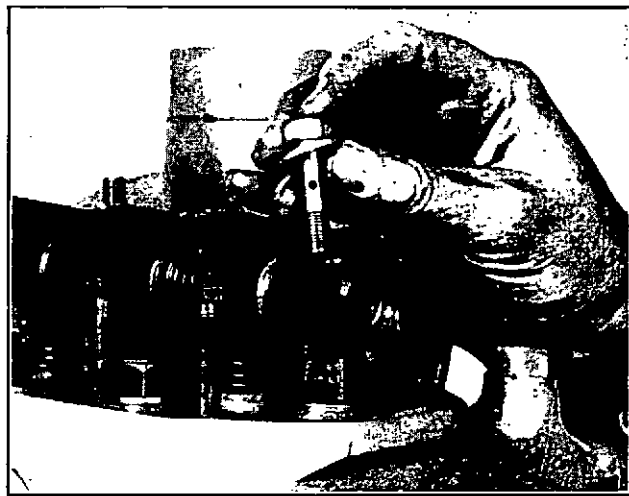

Illustration No. 52

## VALVES

The intake and exhaust valves are made of special steel and operate in valve guides pressed into the cylinder head. They are held on to their seats by strong steel springs, which are fastened to the valves by suitable spring seats and valve lock arrangement. The valves, being located in the cylinder head, are operated by conventional type tappets with hollow push rods running from the tappets to the rocker arms. The rocker arms are lubricated by means of oil forced through a hollow cylinder head screw, Illustration No. 52, into the shaft on which they rotate. Oil is forced out, through small holes in the rocker arms, over the valve stems and push rods. The replacement of valves and valve guides will be found under the subject of "Valve Grinding." The replacement of valve tappets will be found under the subject of "Valve Tappets."

Some engines are equipped with a valve rotocap, which controls the motion of the valve during the lift cycle, but the valve is not located in any way which would prevent turning. The natural vibrations of the valve train and the flow of gases around the valve head cause the valve to rotate slowly, a small fraction of a revolution each lift cycle.

The rotocap requires no special attention other than to see that it is thoroughly cleaned when removed for valve overhaul jobs.

In order to continue to get good performance from an engine, it may be necessary to grind or reseat the valves at varying intervals. The frequency for doing this depends on the care in the operation of the engine. If the air cleaners have been properly cared for; if all connections between the air cleaner and carburetor have been kept air tight; if the lubricating oil has been properly maintained; and if the clearance between the valve stem and rocker arm has been properly adjusted, valve grinding will be necessary very infrequently. Their seating should be tested periodically by rocking the engine against compression. When the engine will not rock, compression is leaking through either the valves, cylinder head gasket or past the piston rings. Check the leak by listening for a "hissing" sound, when the engine is cranked by hand, either at the cylinder head gasket or in the crankcase breather. If at the cylinder head gasket, remove the head and replace the gasket. If in the breather, dismantle the engine and install new parts for those found worn or scored. If no "hissing" is heard at either of these two places, remove the cylinder head and valves. Clean both thoroughly, removing all carbon and oil. Inspect the valve seats and valves. See "Valve Grinding."

### TO REMOVE THE VALVES

1. Remove the cylinder head. See "Cylinder Head."
2. With a clamp type valve spring compressor, compress the valve springs and remove the valve seat locks.
3. Remove the valve springs and seats and lift out the valves. Place the valves in a cardboard or wood block, drilled and numbered so that the valves may be reinstalled in their respective places when grinding or reassembling (do not mark the valves with a file or punch).
4. Clean all carbon from the cylinder head, piston heads, valve seats, valve guides and valves with suitable scraping or buffing tools.

### VALVE GRINDING

Inspect the valve guides for excessive wear. If the valve guides are to be renewed, this should be done before any work is done on the valve seats. This will insure the seat being finished square with respect to the new guide. The exhaust valve guides will usually show the most wear. To drive out the guides, use a drift  $\frac{5}{8}$ " in diameter with a  $\frac{3}{8}$ " diameter pilot. Drive in the new guides to the same depth location as the old guides. After the new guides are driven in, they must be reamed to size on the inside diameter to correct any squeezing in or possible distortion due to being driven into place. This is important in order to get a proper fit and the proper clearance. See "Clearance Table."

Inspect the valve seats; and, if they are pitted or if new guides have been installed, the seats should be refinished. Valve seat tools with  $\frac{3}{8}$ " diameter pilots are required. The exhaust valve seats are finished on a  $45^\circ$  angle and should have an even width all the way around. The intake valve seats are usually finished on a  $45^\circ$  angle, although some engines may have  $30^\circ$  seats. Reseat the seats with a vibrating angle grinder type reseating tool. Because of the large diameter and surface of the valve seats, it is very difficult to obtain a good reseating job with a reamer type tool. Remove all shoulders and pits from the seat but do not grind any deeper than necessary. Then finish the new or refaced valve to the resealed seat by hand in the usual manner.

Inspect the valves carefully; and, if the stems are badly worn or are not straight or if the valves are deeply pitted, the valves should be replaced by new ones. However, valves that are only slightly pitted can be used by refacing them on a valve grinder. Valves must have an accurately finished face of the correct angle. See "Clearance Table" for the seat face width.

If the valves and seats are not deeply pitted or shouldered or have been refaced, grind or lap each valve to its seat. Obtain a light coil spring with enough tension to just hold the valve off the seat. Lubricate the valve stem and apply a thin coating of good quality, medium coarse grinding compound on the valve face. Insert the valve in the valve guide and rotate the valve back and forth, about a quarter of a turn, a few times, pressing firmly on the grinding tool. (Avoid continuous round and round motion that would cut grooves in the valves or seat.) Release the pressure on the tool and the spring should lift the valve from its seat. Rotate the valve  $15^\circ$  or  $20^\circ$  and repeat the grinding process. It will probably be necessary to wipe off and inspect the valve and seat during this process to see what progress is being made; also, the compound may wear off the surface being ground. In either case, reapply another thin coating of compound and continue grinding until inspection shows the surfaces are in contact. Then wipe off all heavy compound and apply a thin coating of "fine" compound and continue the grinding. When the surfaces are "finished"

## DESCRIPTION AND MAINTENANCE

and show a bright, silver-like band of uniform width on both the valve and seat, clean off all traces of the compound. Test each valve for a tight fit by making ten or twelve pencil marks, equally spaced, across the valve seat and firmly rotate the valve in the seat for a part of a turn and again lift out the valve and observe if all the pencil marks are rubbed out on the contact surface. If not, regrind until this test shows a gas tight mating of the valve and seat. **NOTE:**—It is imperative that the valves be assembled in the same seats to which they were ground.

### TO ASSEMBLE THE VALVES

1. Thoroughly clean all traces of the grinding compound off the valves, stems and guides; put a few drops of oil on the valve stems and insert the valves.
2. Using a valve spring compressor, compress the valve springs and insert the valve locks.
3. Turn the head on the exhaust manifold side and pour gasoline in the intake openings. If gasoline seeps out around any valve, remove that valve and regrind. Repeat the test, pouring gasoline in the exhaust openings. If any exhaust valves leak, regrind.
4. Install the cylinder head and valves on the engine. See "Cylinder Head."

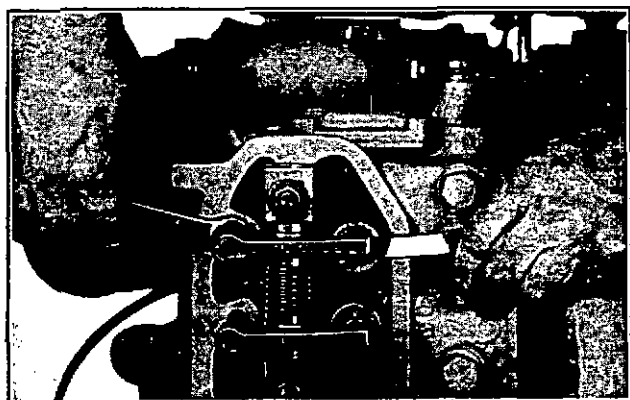

Illustration No. 53

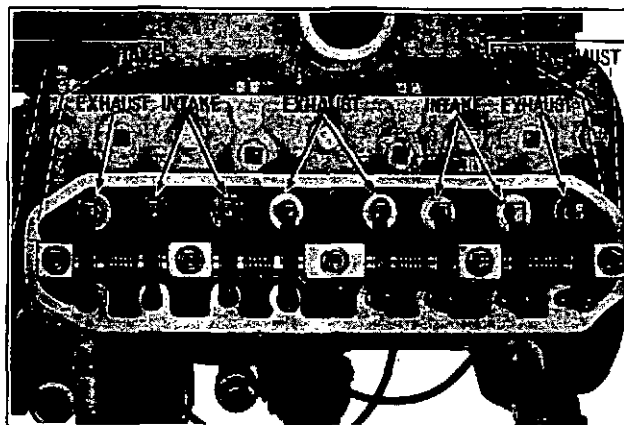

Illustration No. 54

5. Adjust the valve tappets, Illustration No. 53, to the approximate setting. See "Clearance Table." This may be readily and systematically accomplished in the following manner. Perusal of the following paragraphs and Illustration No. 54 will point out that the spotting of the crankshaft and rocker arms follows the firing order (1-2-4-3 for the four cylinder engine and 1-5-3-6-2-4 for the six cylinder engine) of the engine (starting from the timing gear end). The valve tappet screws are self-locking and, therefore, no lock nut is used.

**NOTE:**—Illustration No. 55 is not of a GO series engine, however, the valve location is the same.

- a. Crank the engine over until the intake valve of No. 1 cylinder just starts to open. Then adjust the tappets on No. 4 cylinder (No. 6 cylinder in a six cylinder engine).
- b. Crank the engine over until the exhaust valve of No. 2 cylinder just closes and the intake valve of No. 2 cylinder just starts to open. Adjust the tappets on No. 3 cylinder.
- c. Crank the engine over until the valves of No. 4 cylinder are in the position noted above and adjust the tappets on No. 1 cylinder.
- d. Crank the engine over until the valves on No. 3 cylinder are in the position noted above and adjust the tappets on No. 2 cylinder.

The same outline is applicable to the six cylinder engine except that the six cylinder firing order must be followed; i.e., from a. above, crank the engine over until the exhaust valve of No. 5 cylinder just closes and the intake valve of No. 5 cylinder just starts to open. Adjust the tappets on No. 2 cylinder. Complete the adjustment, following the six cylinder engine firing order, as follows: Spot the valves for No. 3 cylinder and adjust No. 4. Spot the valves for No. 6 cylinder and adjust No. 1. Spot the valves for No. 2 cylinder and adjust No. 5. Spot the valves for No. 4 cylinder and adjust No. 3.

The above completes the valve tappet adjustment until after the engine is started and warmed up to operating temperatures, at which time the valve tappets should be readjusted to the correct hot operating clearance.

6. Install the cylinder head cover and any other parts that may have been removed.
7. Fill the cooling system with water or a cooling solution. Start the engine and warm up to operating temperatures.
8. With the engine idling slowly, readjust the tappets to the correct operating clearance.

### VALVE TAPPETS

The valve tappet is of the mushroom type and is hollow to receive the push rods.

#### TO REMOVE THE VALVE TAPPETS

1. Remove the camshaft. See "Camshaft."
2. Remove the tappets from the cylinder block.
3. Check the tappets for wear and replace any that have excessive clearance.

#### TO INSTALL THE VALVE TAPPETS

1. Check each tappet in the cylinder block position to see that it has the correct clearance, see "Clearance Table," and install the tappets.
2. Reassemble the camshaft. See "Camshaft."
3. Adjust the valves. See "Valve Grinding."

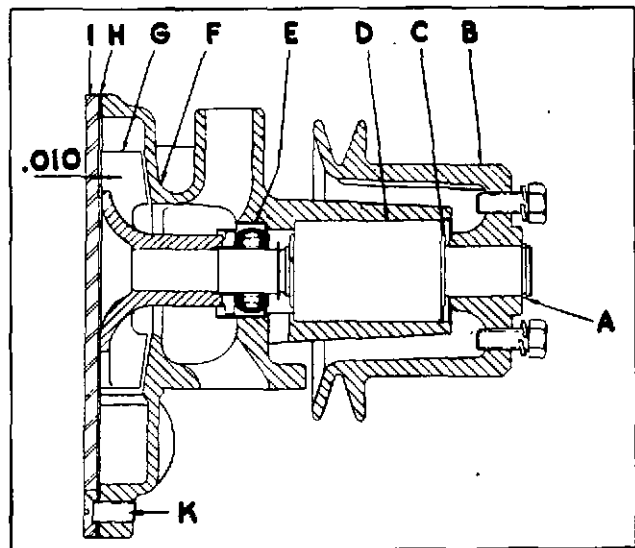

Illustration No. 55

### REMEMBER

**GOOD OIL CHANGED FREQUENTLY . . . OIL FILTER  
ELEMENTS REPLACED OFTEN . . . BREATHER AND AIR  
CLEANER KEPT CLEAN AND FUNCTIONING PROPERLY . . .  
AND ENGINE IN GOOD ADJUSTMENT . . . MEAN LONGER  
LIFE TO THE ENGINE AND TROUBLE-FREE OPERATION**

**LUBRICATION is your biggest asset to offset your greatest liability  
. . . Unnecessary Repairs**

**WATER PUMP AND FAN ASSEMBLY**

Illustration No. 55 shows a sectional view of the water pump and fan (blade is not shown) as used on these engines. This pump may be readily removed from the engine after the removal of the water inlet hose, bypass hose and fan blade. Then, remove the water pump to cylinder block attaching screws and lift the pump away from the engine. Illustration No. 56.

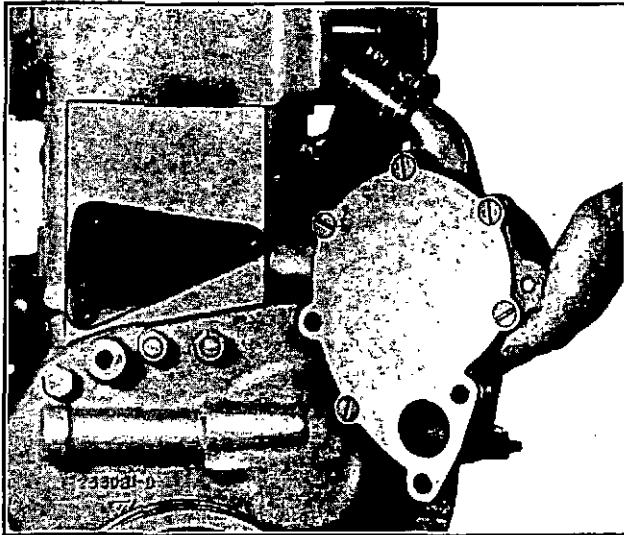

Illustration No. 57

**TO DISASSEMBLE THE PUMP**

(Letters refer to Illustration No. 55)

1. Remove the snap ring (A) and pull the fan pulley hub (B) from the pump shaft and remove the snap ring (C).
2. Remove the screws (K) from the water pump to cover plate and remove the plate (I) and gasket (H).
3. Place the front of the pump on a suitable support in an arbor press and press the shaft and bearing assembly out of the pump body (F) and impeller (G).
4. Press the seal (E) out of the pump body.

The shaft and bearing assembly (D) is one unit and no attempt should be made to disassemble these parts.

Wash and clean all parts thoroughly; inspect for wear and damage. It is advisable to reface the seal surface of the impeller if it is grooved or otherwise marked. Put a coating of grease on the seal surface before starting reassembly of the pump.

**TO ASSEMBLE THE PUMP**

1. Press the new seal (E) into the pump body (F).

**CAUTION:**—Press on the outer flange of the seal to avoid damaging the seal.

2. Press the shaft and bearing assembly (D) into the body (F).

**CAUTION:**—Press only on the outer bearing face of the bearing and not on the end of the shaft.

3. Install the snap ring (C). Supporting the pump shaft on the outer shaft end, press the impeller (G) on to the shaft.

**NOTE:**—The impeller should be pressed on to a position which permits .010" clearance between a straight edge and the impeller when the straight edge is placed across the rear face of the pump body.

4. Support the pump on the impeller end of the shaft and press the fan drive pulley (B) on to the shaft and install the snap ring (A).
5. Install the new cover gasket (H) and pump cover (I), with the screws (K) as removed.
6. Test the rotation of the fan to see that it does not bind or have any excessive resistance.

When installing a water pump always use a new gasket and tighten the attaching screws evenly and alternately to prevent possible damage.

## WIRING DIAGRAM

Due to many types of electrical equipment and the variety of requirements encountered in different installations, it is impossible to illustrate a typical wiring diagram.

However, the installation of wiring circuits may be more readily understood if the complete system is divided as follows:

### 1. THE STARTER SYSTEM:

This circuit consists of the battery (electrical energy storage unit), the starting motor and the necessary wiring to connect the battery to the starter switch and from the starter switch to the starter.

In most cases, the ground or return flow of current is carried through the framework of the unit to a point near the battery from where a short cable is connected to the battery to complete the circuit.

When a magnetic type starter switch is used, it is necessary to connect it to a control switch which may be either a two-position ignition switch or a simple push button switch. The two-position ignition switch has a terminal post which is connected to the magnetic switch with suitable wire. The magnetic switch may have an external ground post which must be grounded to the unit framework. The push button switch has one side connected to either the ignition side of the ignition switch or the battery side of the ammeter and the opposite side connected to the magnetic starter switch as outlined above.

### 2. BATTERY CHARGING SYSTEM:

The battery charging system consists of a generator which creates the electrical current, a regulator to control the current and an ammeter to indicate the amount of current being created or used.

The generator may be either a 3-brush or a 2-brush type, depending on electrical requirements.

The 3-brush generator utilizes movement of the third brush to control the amount of current being created: this type of generator may have either a simple cutout relay (which prevents reverse flow of current and a discharged battery when the generator is not charging) or a two-stage regulator which, in addition to the cutout relay, has an additional unit which controls the voltage of the current being created.

With the 2-brush generator, a three-stage regulator is used. This type of regulator has the cutout relay, voltage control unit and an ampere control unit.

The single or two-stage control units are usually mounted on the generator and connected to wires incorporated in the generator.

To connect this system to the starting system and battery, one wire is connected from the battery terminal of the control unit to one side of the ammeter and from the other side of the starter switch.

With the 2-brush generator and three-stage control unit, it is necessary to supply two or more additional wires. One wire is connected from the field terminal post of the generator to the field terminal of the control unit (regulator) and one wire from the armature terminal post of the generator to the armature terminal of the control unit.

When 2-brush generators which are not internally grounded are used, it is necessary to have an additional wire from the base of the control unit (regulator) to the frame of the generator.

### 3. IGNITION SYSTEM:

The ignition system consists of a key switch, coil, distributor, condenser, spark plugs and wiring necessary to connect the various units.

From the ammeter a wire is connected to the battery side of the ignition switch. The ignition side of the switch is connected to the input post of the coil. The output side of the coil is connected to the distributor primary terminal. The condenser is also connected to the primary terminal of the distributor.

The high tension (secondary) circuit of the ignition originates in the coil and is carried to the center of the distributor cap where it is transferred to the distributor rotor which, as it rotates, allows the current to discharge to the proper spark plug, through suitable wires, at the proper instant.

### 4. ACCESSORY SYSTEM:

The accessory system consists of lights, horns, heaters, etc.

The current to operate these accessories is usually taken from the ammeter to a suitable switch, which allows the accessories to be operated or turned off as necessary.

There are many variations of wiring systems: however, if they are broken down as outlined above, no trouble should be encountered in tracing troubles.

## ENGINE TROUBLE SHOOTING

This section is devoted to giving the operator and maintenance crew some hints in tracing trouble, these suggestions being based on actual experience of servicing a great number of engines in various types of operation over a long period of time.

In order to locate trouble under different headings, refer to the "Index."

### A. ENGINE MISSES INTERMITTENTLY

Cause: Spark plugs dirty, cracked or shorted by moisture on the electrodes.

Correction: Clean, if dirty. Replace, if cracked. Dry, if wet or damp.

Cause: High tension wires broken or shorted.

Correction: Replace the wires.

Cause: High tension wires corroded in the distributor cap.

Correction: Clean the terminals.

Cause: Faulty distributor points, spark plug points, condenser or coil.

Correction: Clean and adjust or replace, if necessary, from spares.

Cause: Valve tappets adjusted too close.

Correction: Readjust the valve tappets to the correct clearance. See "Clearance Table."

Cause: Badly worn valve guides.

Correction: Replace the valve guides.

Cause: Leaking head gasket.

Correction: Tighten the cylinder head nuts to the proper tension or replace the gasket, if necessary.

Cause: Warped or cracked cylinder head usually due to overheating or pouring cold water in an overheated engine.

Correction: Replace the cylinder head.

Cause: Cracked valve seat or water jacket, usually indicated by overheating and loss of cooling solution.

Correction: Replace the cylinder block.

Cause: Air leak in the intake manifold.

Correction: Replace the gaskets or manifold, if necessary.

### B. LOSS OF POWER

Cause: Motor missing intermittently.

Correction: See part A above for the cause and correct.

Cause: Motor out of time.

Correction: Retime the ignition system. See "Ignition Timing."

Cause: Valves or valve seats worn and leaking.

Correction: Regrind the valves. See "Valve Grinding."

Cause: Piston rings broken, stuck in the grooves or worn.

Correction: Replace the rings and clean the ring grooves in the piston.

Cause: Tappets sticking or set too close.

Correction: Readjust the tappets, or if sticking, remove and clean.

Cause: Worn pistons, rings, et cetera.

Correction: Replace the worn parts or rebuild the engine.

- Cause: Spark plugs leaking.  
 Correction: Tighten the spark plugs in the head.
- Cause: Worn cylinders.  
 Correction: Rebore the cylinders and install new oversize pistons and rings.
- Cause: Worn valve stems or guides.  
 Correction: Replace the valves or guides.
- Cause: Valve springs weak or broken.  
 Correction: Replace the springs.
- Cause: Valve timing incorrect.  
 Correction: Correct the timing. See "Camshaft."
- Cause: Poor carburetor action.  
 Correction: Clean or repair the carburetor.
- Cause: Water or sediment in the fuel tank or filter.  
 Correction: Clean the fuel system.
- Cause: Air cleaner clogged.  
 Correction: Wash the element in a suitable cleaning solution such as gasoline, fuel oil, et cetera.
- Cause: Exhaust pipes or muffler restricted.  
 Correction: Clean or replace the exhaust pipe, muffler or tail pipe.

**C. ENGINE KNOCKING**

- Cause: Loose or worn main bearings.  
 Correction: Replace the main bearings.
- Cause: Loose or worn connecting rod bearings.  
 Correction: Adjust or replace the bearings.
- Cause: Loose piston pins.  
 Correction: Replace the pins with oversize pins or a piston and pin assembly.
- Cause: Worn cylinder bores and pistons.  
 Correction: Rebore the cylinders and install new oversize pistons.
- Cause: Tight piston pins.  
 Correction: Fit the pins to the proper clearance. See "Clearance Table."
- Cause: Tight pistons.  
 Correction: Fit the pistons to the proper clearance. See "Clearance Table."
- Cause: Overheated engine.  
 Correction: Allow the engine to cool, then determine the cause of overheating. See "Cooling System."
- Cause: Lack of lubricating oil.  
 Correction: Fill the crankcase with the proper grade and quantity of oil. If the engine still knocks, check and replace the bearings.
- Cause: Loose flywheel.  
 Correction: Tighten in place; if worn excessively by running loose, replace.
- Cause: Excessive end play in the camshaft.  
 Correction: Adjust with the screw in the gear cover. See "Gear Cover."
- Cause: Idler gear shaft has excessive end play.  
 Correction: Adjust with the screw in the gear cover. See "Gear Cover."
- Cause: Bent connecting rod.  
 Correction: Check and straighten or replace, if necessary.

## TROUBLE SHOOTING

---

### D. FUEL SYSTEM

**1. Excessive fuel consumption. This is usually accompanied by increased lubricating oil consumption due to dilution of the oil.**

Cause: Carburetor worn or not properly adjusted. Indicated by black smoke in the exhaust

Correction: Check and repair the carburetor.

Cause: Fuel leaks.

Correction: Check the fuel tank, lines, connections, et cetera.

Cause: Sticking controls.

Correction: Oil the controls and eliminate the binding.

Cause: Excessive idling of the engine.

Correction: Shut off the engine when not in operation.

Cause: Excessive use of the choke.

Correction: Warm the engine to the operating temperature before applying the load, if possible; also, keep the choke mechanism properly adjusted.

Cause: Dirty air cleaner accompanied by lack of power.

Correction: Clean the air cleaner.

Cause: Engine overheating.

Correction: See Overheating under "Cooling System," paragraph E-1.

Cause: Engine in poor condition and adjustment.

Correction: Overhaul the engine.

Cause: Poor or weak ignition, indicated by the engine misfiring and puffs of smoke from the exhaust.

Correction: See "Ignition System," paragraph G-3.

Cause: Dirty and improperly adjusted spark plugs.

Correction: Clean and adjust.

Cause: Engine overcooling.

Correction: See "Cooling System," paragraph E-2.

**2. Fuel pressure too low.**

Cause: Air leak in the system.

Correction: Tighten the connections and check the supply lines for leaks; replace, if necessary.

Cause: Fuel pump diaphragm out of order, also causing increased lubricating oil consumption due to oil dilution.

Correction: Replace the diaphragm. See "Fuel Pump."

Cause: Fuel pump rocker arm linkage worn.

Correction: Rebuild the fuel pump (see "Fuel Pump") or replace from spares.

Cause: Fuel pump check valves and springs not functioning properly.

Correction: Clean or replace the valves and springs.

**3. Lack of fuel at the carburetor.**

Cause: Empty fuel tank.

Correction: Fill the tank with fuel.

Cause: Bent, kinked or broken fuel lines.

Correction: Straighten or replace the lines.

Cause: Dirty filtering screens.

Correction: Clean the filter screen. When replacing the element in the fuel filter, tightening the clamp nut finger-tight is sufficient.

## HERCULES MOTORS CORPORATION

---

- Cause: Fuel leaks.
- Correction: Check the tank, lines, connections, et cetera.
- Cause: Broken fuel pump diaphragm.
- Correction: Replace the diaphragm. See "Fuel Pump."
- Cause: Sticking fuel valve in the carburetor.
- Correction: Replace the fuel valve and seat.
- Cause: Loose fuel pump cover plate screws.
- Correction: Tighten the screws.

### 4. Improper idling.

- Cause: Sticking control rods or linkage.
- Correction: Oil the connections and eliminate the binding.
- Cause: Idling screw not properly adjusted.
- Correction: Adjust the screw for even idling.
- Cause: Carburetor fuel and air mixture not properly adjusted.
- Correction: Adjust the carburetor.

## E. COOLING SYSTEM

### 1. Overheating

- Cause: Lack of cooling solution, water, anti-freeze, et cetera.
- Correction: Refill the system with the proper solution.
- Cause: Fan belt not properly adjusted.
- Correction: Adjust the fan belt for approximately 1" deflection.
- Cause: Carburetor choke valve partly closed.
- Correction: Adjust the choke valve or controls.
- Cause: Thermostat sticking in the closed position.
- Correction: Clean and test or replace.
- Cause: Coating of calcium salts on the cylinders and the inside of the cooling system.
- Correction: Clean and flush the cooling system. The use of a good commercial type inhibitor may be recommended by the manufacturer of the radiator.
- Cause: Dirt or insects in the radiator passages.
- Correction: Clean or blow out with compressed air.
- Cause: Hoses deteriorated. Cannot always be determined by the condition of the outside covering.
- Correction: Replace the hose.
- Cause: Inlet or outlet hoses collapsing.
- Correction: Replace the hoses, using a hose with an inner support, if necessary.
- Cause: Water pump not functioning.
- Correction: Check and replace the drive shaft, impeller, supply lines, et cetera.
- Cause: Exhaust pipes restricted, usually noted by a hissing sound in the exhaust.
- Correction: Clean the pipes and remove the restriction.

### 2. Overcooling

- Cause: Thermostat sticking open.
- Correction: Clean and test or replace the thermostat.
- Cause: Weather or climatic conditions too cold to allow the thermostat to hold temperature.
- Correction: Cover the radiator sufficiently to bring the water temperature into the proper range or use winter front.

## TROUBLE SHOOTING

---

### 3. Loss of cooling water

- Cause: Leaks in the radiator core.  
Correction: Repair or replace.
- Cause: Defective hose connections.  
Correction: Tighten the clamps or replace the hose or clamps.
- Cause: Radiator tubes clogged.  
Correction: Clean or replace.
- Cause: Water pump seals defective.  
Correction: Replace the seals. See "Water Pump."
- Cause: Loose freeze plugs (core plugs) in the cylinder block.  
Correction: Tighten or replace the plugs.
- Cause: Cracked cylinder head or block. Blown cylinder head gasket.  
Correction: Replace.

## F. CLUTCH ASSEMBLY

### 1. Slipping

- Cause: Improper adjustment.  
Correction: Adjust.
- Cause: Weak pressure spring.  
Correction: Replace the spring.
- Cause: Sticking release sleeve.  
Correction: Check the sleeve pressure spring.
- Cause: Worn facings on the driven disc assembly.  
Correction: Replace the facings or the disc assembly.
- Cause: Facings saturated with oil.  
Correction: Clean the facings and correct the cause. Check the oil seal in the bellhousing, also, the pilot on the flywheel. Do not over-lubricate the clutch shafts, bearings, et cetera.

### 2. Chattering

- Cause: Oil on facings.  
Correction: Clean or replace the facings.
- Cause: Sticking release sleeve.  
Correction: Check the pull back spring. If broken, replace.

### 3. Rattling

- Cause: Loose release fork.  
Correction: Tighten the fork.
- Cause: Weak or broken pull back spring.  
Correction: Replace the spring.
- Cause: Improper pedal adjustment.  
Correction: Adjust the pedal.

## G. ELECTRICAL SYSTEM

### 1. Starting motor

- (a) Slow cranking speed may be caused by:

- Cause: Crankcase lubricating oil too heavy or cold.  
Correction: Change to the correct grade of oil or heat the oil before attempting to start the engine. See "Lubrication."

## HERCULES MOTORS CORPORATION

Cause: Loose or dirty cable connections.  
Correction: Clean and tighten.  
Cause: Worn brushes.  
Correction: Replace the brushes.  
Cause: Dirty or worn armature.  
Correction: Clean, repair or replace the armature.  
Cause: Armature rubbing the field coils.  
Correction: Replace the starter shaft bushings.  
Cause: Low battery voltage.  
Correction: Check the generator and regulator, then recharge the battery.

(b) Starter failing to operate may be caused by:

Cause: Battery discharged.  
Correction: Recharge the battery.  
Cause: Burned circuit breaker.  
Correction: Replace the circuit breaker.  
Cause: Broken battery cables.  
Correction: Replace the cables.  
Cause: Poor connections.  
Correction: Clean and tighten.  
Cause: Burned commutator bars.  
Correction: Recut the commutator.  
Cause: Open or short circuits in the armature or fields.  
Correction: Check and repair.  
Cause: Defective starter switch (push button or solenoid).  
Correction: Check and repair the contacts or replace the switch.

### 2. Generator

(a) Low or no output

Cause: Fully charged battery.  
Correction: None. Check the output when the battery is slightly discharged.  
Cause: Dry battery.  
Correction: Refill the cells with distilled water.  
Cause: Burned contacts on the regulator units.  
Correction: Clean or replace the contacts.  
Cause: Grounded armature wires or terminal posts.  
Correction: Replace the wires and insulate the terminals.  
Cause: Burned commutator bars.  
Correction: Recut the commutator.  
Cause: Worn or sticking brushes.  
Correction: Clean or replace the brushes.  
Cause: Open circuits in the field or armature.  
Correction: Repair or replace the defective parts.  
Cause: Brush springs weak or improperly adjusted.  
Correction: Adjust or replace the springs.  
Cause: Rough, dirty or greasy commutator bars.  
Correction: Clean the commutator bars.

## TROUBLE SHOOTING

---

Cause: High mica on the commutator.

Correction: Undercut the mica.

Cause: Commutator out of round.

Correction: Recut the commutator.

### (b) Noisy generator

Cause: Loose mountings.

Correction: Tighten the mounting bolts.

Cause: Worn or loose drive pulley.

Correction: Tighten or replace the pulley.

Cause: Worn bearings.

Correction: Replace the bearings.

### (c) Excessive output

Cause: Generator field grounded.

Correction: Check the wires, et cetera, for external ground.

Cause: Regulator circuit breaker closed.

Correction: Adjust or repair the circuit breaker. Check the generator for damage.

Cause: Defective regulator.

Correction: Replace the regulator.

## 3. Ignition system—distributor, coil and spark plugs.

### (a) Engine will not start

Cause: Breaker points not closing.

Correction: Check and adjust.

Cause: Breaker points defective.

Correction: Check and replace, if necessary.

Cause: Breaker arm grounded.

Correction: Replace the arm.

Cause: Defective cap or rotor.

Correction: Check and replace.

Cause: Defective coil.

Correction: Replace the coil.

Cause: Defective condenser.

Correction: Replace the condenser.

Cause: Loose terminals or grounded wires.

Correction: Check and tighten or replace.

### (b) Engine misses at low speed

Cause: Breaker point gap too small.

Correction: Check and adjust the gap to the proper setting. See "Ignition Timing."

### (c) Engine misses at high speed

Cause: Breaker arm spring tension too weak.

Correction: Replace the spring or the spring and arm.

Cause: Breaker point gap too large.

Correction: Adjust the gap.

## HERCULES MOTORS CORPORATION

- (d) Engine pings excessively under load at high speed  
Cause: Timing too far advanced or incorrectly set.  
Correction: Check and properly adjust. See "Ignition Timing."  
Cause: Inferior grade of fuel.  
Correction: If it is impossible to obtain the proper grade of fuel, it may be necessary to retard the spark or distributor timing somewhat to overcome the pinging noise.
- (e) Weak spark at the plugs  
Cause: Breaker contact points worn or defective.  
Correction: Examine; repair or replace the points.  
Cause: Condenser disconnected or defective.  
Correction: Test the connection or replace the condenser.  
Cause: Breaker cam worn.  
Correction: Install a new cam and stop plate assembly.
- (f) Engine lacks speed and overheats  
Cause: Breaker cam retarded.  
Correction: Readjust the distributor and advance arm.
- (g) Timing incorrect or irregular  
Cause: Breaker cam loose.  
Correction: Examine the distributor governor weights, pivots, springs, shaft, et cetera. Replace, as necessary.
- (h) Breaker points pitted or burned  
Cause: Grease or dirt on the points.  
Correction: Clean, repair or replace.  
Cause: Defective condenser.  
Correction: Replace the condenser.
- (i) Engine misses at all speeds  
Cause: Distributor points set too far apart.  
Correction: Check and adjust.  
Cause: Condenser defective or disconnected.  
Correction: Check the connection; replace the condenser, if necessary.  
Cause: Breaker point screw lock nut loose.  
Correction: Adjust the points and tighten.  
Cause: Breaker points burned, oxidized or unevenly spaced.  
Correction: Check, clean and adjust; replace, if necessary.

### H. EXCESSIVE SMOKE FROM THE EXHAUST

- Cause: Too much oil in the crankcase.  
Correction: Fill only to the 4/4 or FULL mark on bayonet gauge.  
Cause: Carburetor float sticking or the fuel valve leaking.  
Correction: Adjust or replace the fuel valve and seat. Examine the float for leaks.  
Cause: Worn pistons, rings or cylinders.  
Correction: Replace the worn parts or overhaul the engine.

## TROUBLE SHOOTING

---

### I. EXCESSIVE OIL CONSUMPTION

- Cause: Oil leaks at the gaskets, screws, oil seals, et cetera.  
Correction: Tighten or replace the gaskets, et cetera.
- Cause: Inferior grade of oil.  
Correction: Use a good quality oil. See specifications.
- Cause: Overheating.  
Correction: See "Cooling System," paragraph E-1.
- Cause: Ring gaps too great or lined up.  
Correction: Install new rings. If the ring gaps are lined up, the condition will correct itself.
- Cause: Worn or broken rings.  
Correction: Replace the rings.
- Cause: Cylinder bores out of round or excessive taper.  
Correction: Rebore the cylinders; install new pistons, rings, et cetera.
- Cause: Main or connecting rod bearings loose.  
Correction: Adjust or replace the bearings.
- Cause: Oil ring slots clogged with carbon.  
Correction: Clean the rings. Replace, if necessary.
- Cause: Carburetor fuel mixture too rich.  
Correction: Replace the worn jets and adjust.
- Cause: Piston improperly fitted or installed.  
Correction: Correct or replace the piston. See "Piston, Pin and Rings."
- Cause: Piston rings improperly fitted in the piston grooves or the cylinder bores.  
Correction: Fit the rings properly in the grooves and cylinders. See "Piston, Pin and Rings."
- Cause: Air cleaner not clean, allowing dirt to enter the combustion chamber with resultant wear.  
Correction: Keep the air cleaner clean.

### J. BEARING FAILURES

- Cause: Continuous overspeeding of the engine.  
Correction: Continuous operation at maximum speed, or close to it, is to be avoided. Exercise caution when going downgrade. Do not allow the vehicular speed to exceed the same speed obtainable in the same gear on level terrain.
- Cause: Lack of oil.  
Correction: Keep the oil level at the 3/4 mark on the bayonet gauge.
- Cause: Inferior grade of oil or oil of improper viscosity.  
Correction: Use a good quality oil of the proper viscosity.
- Cause: Low oil pressure.  
Correction: Adjust the oil pressure See "Oil Pressure Adjustment"
- Cause: Bent connecting rod.  
Correction: Replace the connecting rod.
- Cause: Crankshaft rough or out of round.  
Correction: Regrind or replace the shaft.
- Cause: Restricted oil passages.  
Correction: Clean the oil lines and passages.
- Cause: Bearings loose or improperly fitted.  
Correction: Adjust or replace the main or connecting rod bearings.

## HERCULES MOTORS CORPORATION

Cause: Dirt or other matter in the lubricating oil.  
Correction: Use clean oil and service the breather air filter regularly. Replace the oil filter cartridges or the elements.

### K. LOW OIL PRESSURE

Cause: Oil pump strainer screen in the oil pan clogged.  
Correction: Clean the screen.

Cause: Oil too hot, resulting in low viscosity.  
Correction: Correct the cause of the overheating.

Cause: Pressure regulator piston worn or clogged with carbon.  
Correction: Clean and adjust properly.

Cause: Excessive main and connecting rod bearing clearance.  
Correction: Adjust or replace the bearings.

Cause: Oil pressure gauge defective.  
Correction: Replace the gauge.

Cause: Oil pressure gauge line bent or clogged.  
Correction: Clean; straighten or replace the line.

### L. RAPID CYLINDER OR PISTON WEAR

Cause: Breather and air cleaner not properly serviced, allowing dirt and abrasives to enter the combustion chambers.  
Correction: Clean frequently and at regular intervals.

Cause: Inferior grade of lubricating oil.  
Correction: Use a good quality oil. See specifications.

Cause: Lack of oil.  
Correction: Keep the oil level at the 4/4 or FULL mark on the bayonet gauge.

Cause: Dirty oil.  
Correction: Replace or change the oil and replace the oil filter elements.

Cause: Piston rings not properly fitted to the cylinders.  
Correction: Replace the piston rings. See "Piston, Pin and Rings."

Cause: Carburetor fuel mixture too rich.  
Correction: Replace the worn jets.

Cause: Cold operation of the engine.  
Correction: Check the thermostat. Warm the engine before applying the load.

### M. VALVES STICKING

Cause: Incorrect valve tappet clearance.  
Correction: Adjust the clearance correctly. See "Valve Tappets."

Cause: Valve springs weak or broken.  
Correction: Replace the springs.

Cause: Valve stems or guides scored, dirty or gummy.  
Correction: Clean; polish or replace.

Cause: Incorrect clearance between the valve stem and the guide.  
Correction: Fit the valve stems to the correct clearance in the guides.

### N. BURNED VALVES OR VALVE SEATS

Cause: Valve tappet clearance adjusted too close.  
Correction: Adjust the valves to the proper clearance.

## TROUBLE SHOOTING

---

- Cause: Weak valve springs.  
Correction: Replace the springs.
- Cause: Excessive carbon.  
Correction: Remove the carbon deposits.
- Cause: Camshaft not timed correctly.  
Correction: Retime the camshaft. See "Camshaft."
- Cause: Lean fuel mixture.  
Correction: Clean and adjust the carburetor.
- Cause: Valve seats too narrow.  
Correction: Cut the seats to the correct width.
- Cause: Low grade fuel.  
Correction: Use a good quality fuel.
- Cause: Valve heads cut too thin when refacing.  
Correction: Replace the valve.

### O. SPARK KNOCK OR PING

- Cause: Excessive accumulation of carbon in the combustion chamber.  
Correction: Clean or remove the carbon deposits.
- Cause: Hot spot in the combustion chamber due to a carbon deposit or a clogged water passage.  
Correction: Remove the carbon and open the water passage.
- Cause: Motor operating too hot.  
Correction: See "Cooling System," paragraph E-1.
- Cause: Inferior type fuel.  
Correction: Use a good quality fuel.
- Cause: Ignition timing incorrect.  
Correction: Correct or reset the timing.
- Cause: Carburetion or fuel mixture incorrect.  
Correction: Check the carburetor.
- Cause: Spark plug gaps too wide.  
Correction: Adjust the gaps correctly.

### P. EXPLOSION IN THE MUFFLER

- Cause: Ignition too late.  
Correction: Correct the ignition timing.
- Cause: Weak spark.  
Correction: Check the condenser, distributor, coils, wires, et cetera.
- Cause: Exhaust valves holding open.  
Correction: Check the tappet clearance, springs, guides, et cetera.
- Cause: Exhaust valves warped.  
Correction: Reface or replace.

### Q. EXPLOSION IN THE CARBURETOR OR AIR CLEANER

- Cause: Fuel mixture too lean.  
Correction: Clean the carburetor; check the fuel level in the bowl.
- Cause: Intake valves holding open.  
Correction: Check the tappet clearance, springs, guides, et cetera.
- Cause: Intake manifold leaking.  
Correction: Tighten the manifold nuts or replace the gaskets.

# CLEARANCE TABLE

(All Dimensions in Inches)

GO-G SERIES  
3, 4 and 6 Cylinder

	Min.	Max.
Valve seat diameter—exhaust .....	1-15/32	
Valve seat diameter—intake .....	1-21/32	
Face of valve seat—exhaust .....	7/64	
Face of valve seat—intake .....	7/64	
Valve stem clearance in guide, Std. Engine—exhaust and intake .....	.0015	.0025
Valve tappet clearance—exhaust .....	.010	
Valve tappet clearance—intake .....	.010	
Push rod clearance .....	.0005	.0015
Camshaft bearing clearance .....	.0015	.0035
Crankshaft thrust clearance .....	.005	.010
Connecting rod clearance—F-77 .....	.001	.003
Connecting rod side clearance .....	.005	.012
Main bearing clearance—babbitt .....	.0009	.003
Main bearing clearance—D-49 .....	.0009	.0034
Crankshaft gear backlash to camshaft .....	.000	.002
Oil pump gear backlash to camshaft .....	.006	.012
Governor thrust plate axial clearance on cam gear .....	.007	.020
Piston ring gap .....	.015	.020
Piston ring land clearance—top compression .....	.0035	.005
Piston ring land clearance—compression .....	.002	.0035
Piston ring land clearance—oil .....	.0015	.003
Piston pin clearance .....	.0000	Hand Push Fit .0005
Piston pin clearance—in connecting rod .....	.0005	.0012
<b>PISTON CLEARANCE</b>		
3-1/2 BORE .....	.003 to .004	8 lbs. with .004 Ribbon
3-3/4 BORE .....	.003 to .004	8 lbs. with .004 Ribbon
4 BORE .....	.003 to .004	8 lbs. with .004 Ribbon

## TORQUE WRENCH TENSION

Foot Pounds

Cylinder Head Screw .....	140
Cylinder Head Nut .....	140
Connecting Rod .....	56
Main Bearings—Center—(when screw lockplates are used) .....	70
Main Bearings—Front, Rear and Intermediate—(when screw lockplates are used) .....	80
Main Bearings—Center—(self locking type screws) .....	90
Main Bearings—Front, Rear and Intermediate—(self locking type screws) .....	120
Camshaft Gear Nut .....	130
Flywheel .....	80

TOOLS

TOOLS

PART NO.	PART NAME
11462-A	Socket— $\frac{1}{2}$ "
3170-A	Socket— $\frac{9}{16}$ "
3171-A	Socket— $\frac{5}{8}$ "
3109-A	Socket— $\frac{3}{4}$ "
3261-A	Socket— $1\frac{3}{16}$ "
3172-A	Socket— $\frac{7}{8}$ "
203440-A	Deep Socket— $\frac{7}{8}$ "
3168-A	Socket Extension— $\frac{1}{2}$ " x 6"
13587-B	Square Speeder Handle— $\frac{1}{2}$ "
3189-A	Surface Ratchet— $\frac{1}{2}$ "
2252-A	Socket Universal
13077-A	Open End Wrench— $\frac{1}{2}$ " x $\frac{9}{16}$ "
13078-A	Open End Wrench— $\frac{9}{16}$ " x $\frac{5}{8}$ "
13099-A	Open End Wrench— $\frac{3}{4}$ " x $\frac{7}{8}$ "
6359-A	Manifold Wrench— $\frac{5}{8}$ " x $\frac{5}{8}$ "
11927-A	Flex Handle
13171-A	Piston Ring Compressor
13096-A	Valve Spring Lifter
13098-A	Piston Ring Expander
11925-A	Screwdriver - $\frac{3}{16}$ " x 5" Blade
13175-A	Screwdriver - $\frac{1}{4}$ " x 6" Blade
13095-A	Pliers - 9" Heavy Duty
13278-A	Adjustable Wrench
11919-A	Feeler Gauge Set - 9" Blades
11920-A	Lady Foot Pry Bar
11921-A	Ball Pein Hammer—12 oz.
3444-A	Torque Wrench
6335-A	Tool Box

**GOOD TOOLS**  
**HELP COMPETENT MECHANICS DO A BETTER JOB.**

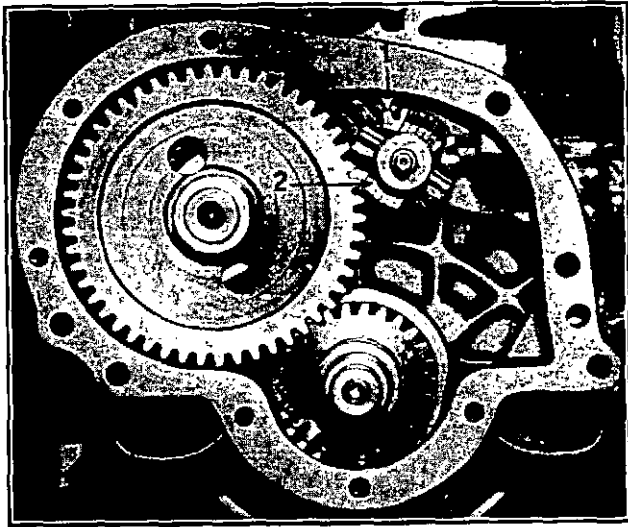

Illustration No. 57

## GOVERNOR

The external type governor is mounted on the gear cover and is gear driven by the camshaft gear. The governor drive gear, Illustration No. 57, Figure 1, drives the governor at  $1\frac{1}{2}$  times engine speed. The centrifugal force exerted by the revolving governor flyweights, Illustration No. 57, Figure 2, cause the movement of a sleeve assembly, which is in constant contact with the governor actuating lever. This movement is opposed by the governor spring which is connected by an adjustable eyebolt to the throttle operating mechanism. The governor control arm is connected to the carburetor butterfly arm by an adjustable control rod. The tension of the governor spring controls the governed maximum speed of the engine.

### TO ADJUST THE GOVERNOR

The maximum travel of the governor arm should be  $\frac{9}{64}$  inches.

1. If it is necessary to adjust the governor arm to carburetor butterfly control rod, the following procedure is suggested:

With the engine shut down and the governor weights in full closed position, adjust the control rod so that the carburetor butterfly is wide open, then shorten the control rod  $\frac{1}{16}$  inch.

2. Start the engine and warm up to operating temperature. Set the governor to the desired maximum engine operating speed by adjusting the governor spring eyebolt. Illustration No. 58, Figure 1.
3. Balance the governor regulation by adjusting the bumper screw adjustment. Illustration No. 58, Figure 2.

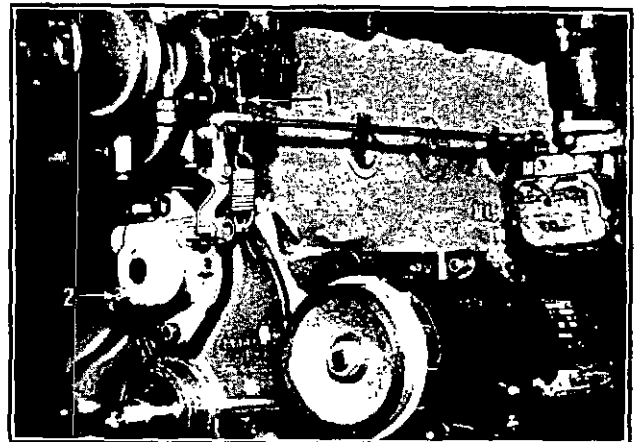

Illustration No. 58

**CAUTION:** Two combinations of drive gears are used.

#### For Distributor Ignition

Crankshaft Gear .....25 Teeth  
 Camshaft Gear .....50 Teeth  
 Governor Drive Gear .....17 Teeth

#### For Magneto Ignition

Crankshaft Gear .....24 Teeth  
 Camshaft Gear .....48 Teeth  
 Governor Drive Gear .....16 Teeth

# **WHITE**

**ENGINES, INC.**

CANTON, OHIO 44707

## **LIMITED WARRANTY**

### **INDUSTRIAL ENGINE**

White Engines, Inc. warrants each new engine or component thereof, sold by it to the original owner-user as follows:

For eighteen (18) months from date of shipment from the factory, or for twelve (12) months of service, or for 2,000 hours of service, whichever shall first occur, (or for such other period of time as may be agreed upon in writing by White Engines, Inc. in respect to the application in which the engine is used) that said engine and component shall be free from defects in material and workmanship.

For any engine or component which is, or becomes defective within the period set forth above, White Engines, Inc. shall furnish to the original owner-user, without charge, parts to replace those parts which upon inspection are determined by White Engines, Inc. to have been defective in material or workmanship.

This warranty does not obligate White Engines, Inc. for the cost of labor or transportation charges in connection with the replacement of defective parts or repair of the engine.

The foregoing warranty does not apply to normal maintenance services or adjustment or to an engine upon which repairs or alterations have been made unless the repairs or alterations were authorized in writing by White Engines, Inc.

White Engines, Inc. makes no warranty in respect to trade accessories. Trade accessories are subject to the warranties of their respective manufacturers.

Other than as set forth above, SELLER MAKES NO WARRANTY OF ANY KIND WHATEVER, EXPRESS OR IMPLIED; AND ANY IMPLIED WARRANTY OF MERCHANTABILITY OR FITNESS FOR A PARTICULAR PURPOSE, OTHER THAN AS CONTAINED HEREIN AND HEREBY LIMITED AS TO DURATION IS HEREBY DISCLAIMED.

THIS WARRANTY SUPERSEDES ANY PREVIOUS WARRANTIES AND TAKES EFFECT SEPTEMBER 1, 1985.