

Installation
EDC III
Industrial engines

I
1(1)

TAD1240GE, TAD1241GE
TAD1242GE, TWD1240VE

Installation

EDCIII

TAD1240GE, TAD1241GE

TAD1242GE, TWD1240VE

Contents

Safety advice	2	TWD1240VE (Stand alone)	32
Special tools	4	General information	32
General information	5	Connection	33
EDC III Fuel system	5	Engine management	33
Component location	7	Warning and indication lamps	35
System voltage 24 V	8	Other	37
TAD1240-42GE (Standalone)	9	System reset	38
General information	9	Wiring diagram	39
Connection	10	Parameter setting	40
Engine management	10	TWD1240VE (CIU)	43
Warning and indication lamps	12	General information	43
Other	14	Connection	44
Synchronization/load distribution	15	Engine management	44
System reset	15	Warning and indication lamps	46
Wiring diagram	16	Instruments	48
Parameter setting	17	Other	50
TAD1240-42GE (CIU)	19	System reset	50
General information	19	Wiring diagram	51
Connection	20	Parameter setting	52
Engine management	20	TWD1240VE (Power Pack)	55
Warning and indication lamps	23	Wiring diagram	56
Instruments	25	Parameter setting	57
Other	27	Fault tracing	60
Synchronization/load distribution	28	Diagnostic function	61
System reset	28	Fault codes	63
Wiring diagram	27		
Parameter setting	30		

Safety advice

Introduction

This instruction book contains the information needed to install and function check the EDC system (electronic control of the fuel injection system).

Read the instruction book carefully before you start installation. If the installation is done in a faulty manner, this can cause personal injury or damage to property and machinery.

If you do not understand, or are unsure about anything in this instruction book, please ask your Volvo Penta dealer for assistance.

Installation

This installation manual is only intended for professional use.

The installation manual is intended to be used together with the relevant engine instruction book.

Volvo Penta declines all responsibility for personal injury or property damage which might occur as a result of not following the installation advice, or if the work is not done by professional personnel.

The installer is responsible for ensuring that the system operates in the manner described in the instruction book.

Work methods

These instructions are intended to be used by suitably qualified personnel. In these instructions, these person(s) is/are referred to as the installer(s).

Also refer to the specific engine instruction book for relevant information when necessary, and in particular for information relating to safety and engine operation.

The work must be done by Volvo Penta workshops, boat yards or other authorized, well-equipped workshop, with qualified and experienced personnel.

Important!

The following special warning symbols occur in this book and on the engine.

⚠ WARNING! Warns for the risk of personal injury, property damage or that a mechanical fault can occur if the instructions are not followed.

⚠ IMPORTANT! Is used to call attention to things which could cause damage or malfunctions to product or property.

NOTE! Is used to call attention to important information, to facilitate work processes or operation.

We have summarized the risks which always must be noted and the precautions to be taken during installation and calibration of the EDC system.

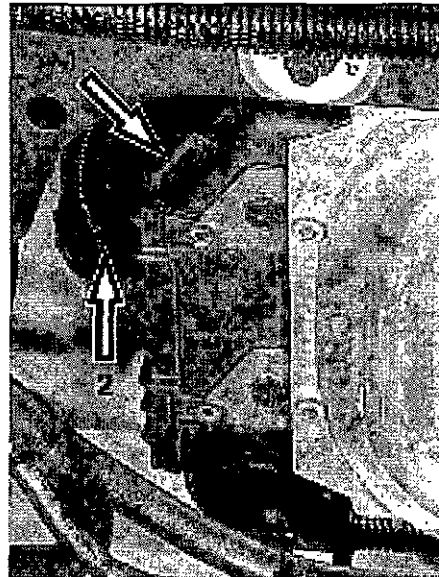

⚠ Before electric welding is done, the connector on the EDC system must be disconnected. This is located behind the fuel cooling coil. Disconnect the engine from system voltage by turning off the main switch. Disconnect the cable connector from the control unit. Press the catch (1) in and move the cable connector (2) upwards. Re-connect the connector on the EDC unit once electric welding work has been completed and the welding equipment has been disconnected.

⚠ Be careful, watch out for the moving components of the engine during function testing and in operation. Approaching the engine during operation entails a risk of personal injury. Remember that loose clothes or long hair can catch on rotating components and cause severe injury.

⚠ Never do any work on an engine which just hangs from a lifting devise (crane etc.).

⚠ The engine must not be run in areas where explosive material or any gases are stored.

⚠ Only start the engine in a well-ventilated area. If the engine is run in a confined space, make sure that the crankcase ventilation and exhaust gases can be led away from the workplace.

⚠ The batter lockers must never be exposed to open flames or sparks. Do not smoke close to the batteries. The batteries generate hydrogen gas when charged, which can form an explosive gas when mixed with air. This gas mixture is very flammable and highly explosive. A spark, which can be formed if the batteries are wrongly connected, is enough to make a battery explode and cause damage. Do not move the connections when you attempt to start the engine (risk of arcing), and do not stand and lean over one of the batteries. Please refer to the advice in the instruction book.

⚠ Always ensure that the + (positive pole) and - (negative pole) are securely connected to their appropriate terminals on the battery. If the batteries are wrongly connected, this can cause severe damage to the electrical equipment. Please refer to the wiring diagram in the engine instruction book.

⚠ Always use goggles when charging and handling batteries. Battery electrolyte contains sulfuric acid, which is highly corrosive. If battery acid comes into contact with your skin, wash it off at once with a lot of soap and water, and then get medical help. If battery acid comes into contact with your eyes, flush your eyes at once (preferably with an eye shower) with a lot of clean water, and then get medical help at once.

Special tools

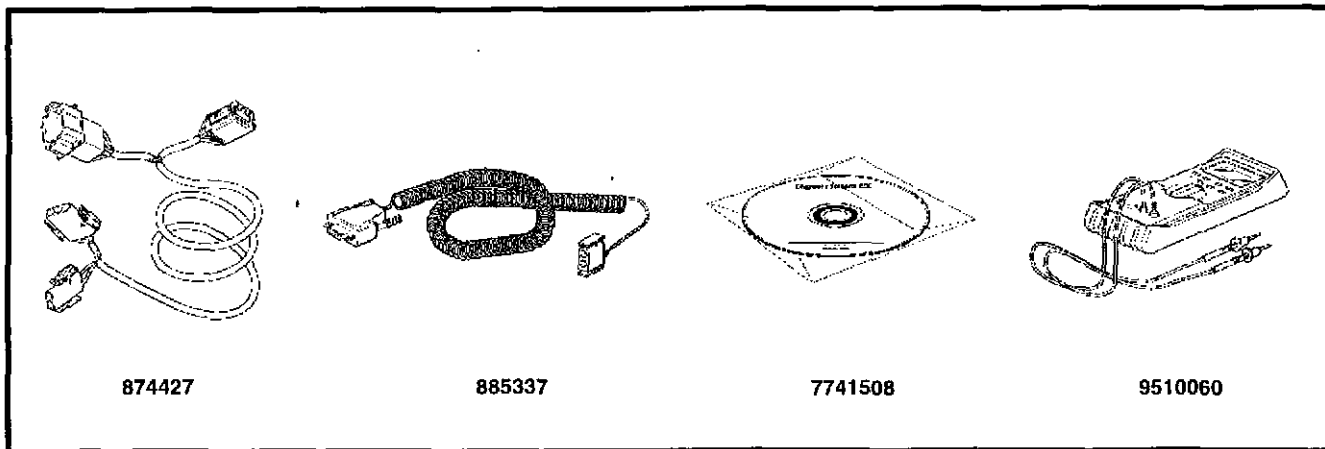

874427-8 T-piece diagnostic connector

885337-6 Communication cable for PC, incl. order form for diagnostic program on CD-ROM (CD not included in 885337-6)

7741508-1 Parameter setting tool*

9510060-8 Multimeter

* software on CD incl. 1 year's subscription

Other special equipment

The tools below are intended for use in work on the cable harnesses of the engine. The tools are not included in Volvo Penta's range, they must be ordered from a local **AMP** or **Deutsch** dealer. If you experience problems in contacting a dealer, please contact Volvo Penta Quality Action Center for advice.

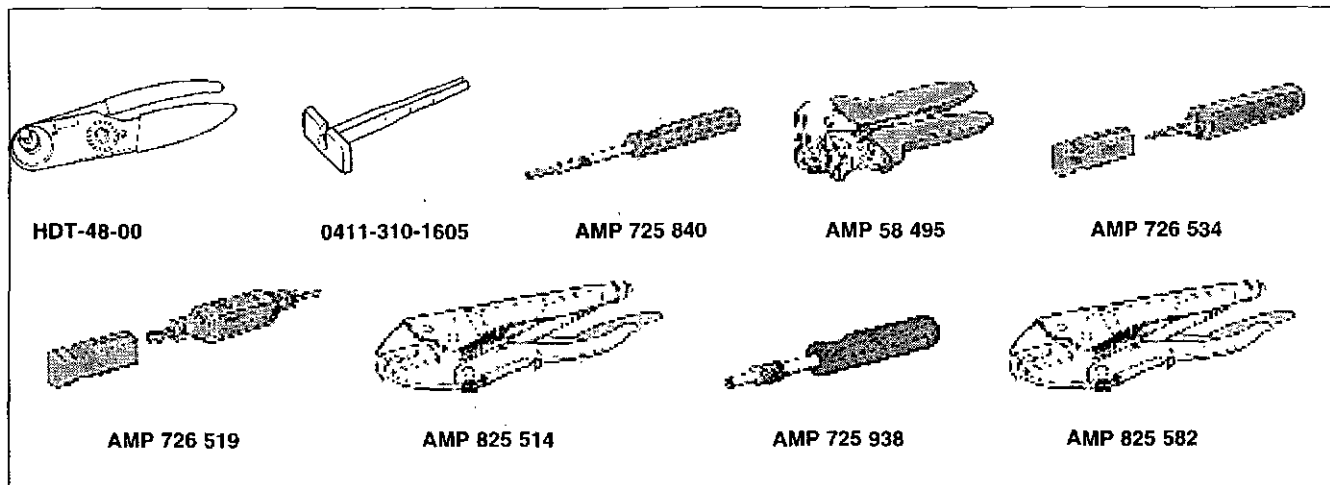

Deutsch connectors

HDT-48-00 Crimping tool

0411-310-1605 Disassembly tool

16-pin CPC connector, d=1.6 mm (0.063")

725 840-1 Disassembly tool

58 495-1 Crimping tool

JPT connector (42-pin EDC, 2 and 3-pin Bosch etc.)

726 534-1 Disassembly tool 1.6 mm (0.063") pin width

726 519-1 Disassembly tool 2.8 mm (0.11") pin width

825 514-1 Crimping tool

Blades and sockets 3.5 mm (0.14")

725 9380 Disassembly tool

825 582-2 Crimping tool

4.8 mm (0.19") and 6.3 mm (0.25") cable clamps. Tongues and socket terminals

825 514-1 Crimping tool

General information

What is EDC III?

EDC III means "Electronic Diesel Control", and is an electronic system with CAN communication for diesel engine control. The system has been developed by Volvo Penta and includes fuel control and diagnostic function. The system consists of a control unit, six unit injectors, a number of sensors which provide the control unit with values, diagnostic connector and function check. The EDC III system also has a so-called "Stand alone" interface which can be connected directly to the engine management unit on the engine. The engine can be connected to a so-called "CAN" interface and to a "Control Interface Unit" (CIU) which is an interface to the driver's controls.

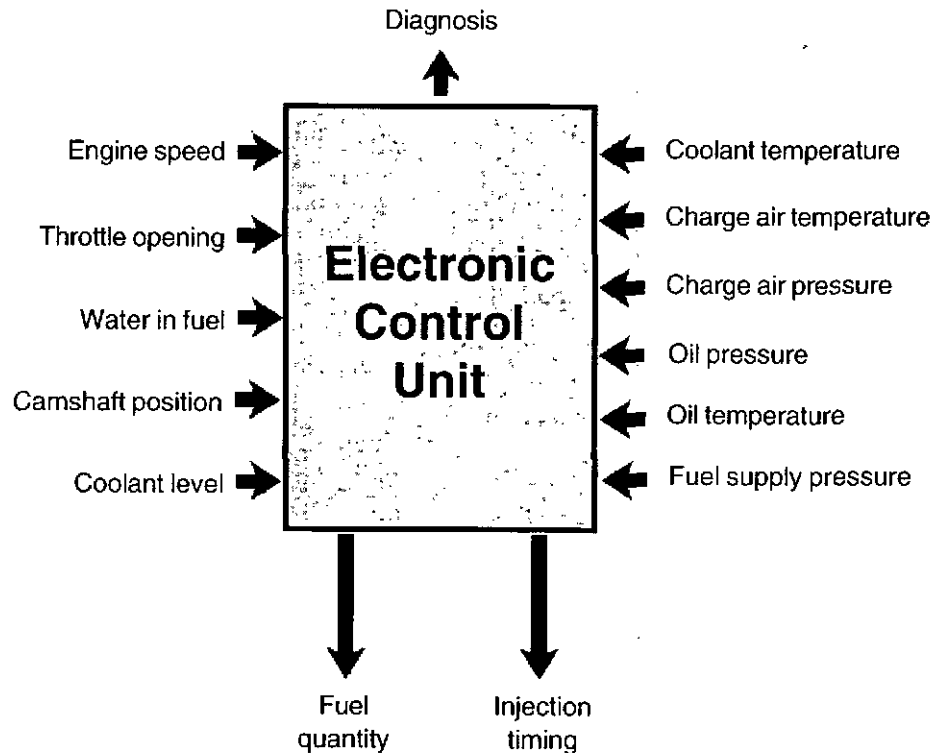

Control unit

The EDC III system processor is encased in the control module and is protected against moisture and vibration. The processor receives continuous information about:

- engine speed
- charge air pressure
- charge air temperature
- coolant temperature
- oil pressure
- oil temperature
- fuel alarm, combined alarm for "water in fuel" and "fuel pressure"
- coolant level

The information provides exact information about current operation conditions and allows the processor to calculate the correct fuel volume, check engine status etc.

Fuel control

The engine fuel requirement is analyzed up to 100 times per second (depending on engine speed). The amount of fuel injected into the engine and the injection advance are fully electronically controlled, via fuel valves and the unit injectors.

This means that the engine always receives the correct volume of fuel in all operating conditions, which offers lower fuel consumption, minimal exhaust emissions etc.

The control unit checks and controls the unit injectors, to ensure that the correct volume of fuel is injected into each cylinder. It calculates and adjusts the injection advance. Regulation is mainly done with the aid of the engine speed sensors and the combined sensor for charge pressure/charge air temperature.

The control unit controls the unit injectors via an electronic signal to the electromagnetically operated fuel valve in each unit injector, which can be opened and closed.

When the fuel valve is open, fuel flows past, through the holes in the unit injectors and out through the fuel duct. Fuel is not injected into the cylinders in this position.

When the fuel valve is closed, pressure is built up by the mechanically driven pump piston in the unit injector. When enough pressure has been built up, fuel is injected into the cylinder via the injection part of the unit injector.

The fuel valve is re-opened and pressure in the unit injector falls at the same time as fuel injection to the cylinder ceases.

The control unit has access to signals from sensors and opening switches to determine when the fuel valve should be opened and closed.

Calculation of fuel quantity

The quantity of fuel to be injected into the cylinder is calculated by the control unit. The calculations give the time that the fuel valve is closed (when the fuel valve is closed, fuel is injected into the cylinder). The parameters which govern the amount of fuel injected are:

- Demanded engine speed
- Engine protection functions
- Temperature
- Charge air pressure

Cylinder balancing

During idling, the control unit can provide the cylinders with different amounts of fuel. This is to give the engine more even idling. At higher engine speeds, this problem does not exist and the cylinders are given the same amount of fuel.

Diagnostic function

The EDC III system has a built-in diagnostic function which allows faults in the engine and sensors to be discovered.

The task of the diagnostic function is to discover and localize any disturbances within the EDC III system, to protect the engine and to ensure operation in the event of serious disturbances.

If a malfunction is found, the diagnostic button indicator in the control panel begins to flash. By pressing the diagnostic button, the operator will receive a diagnostic trouble code (DTC) as a guide for any fault-tracing. The diagnostic function can be read by means of a PC with diagnostic function.

Idling adjustment (low idle)

Idling speed can be adjusted between 600-1200 rpm by means of the parameter tool.

Component location

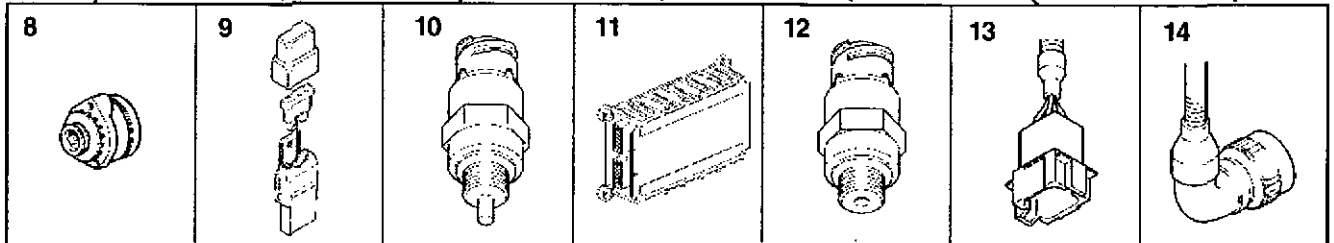
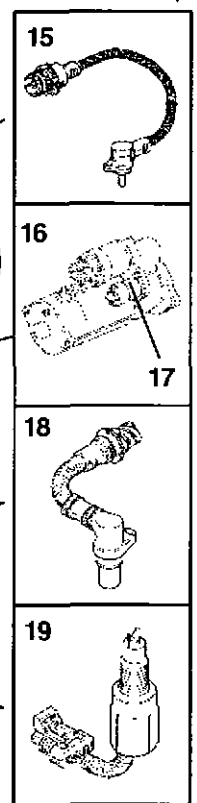
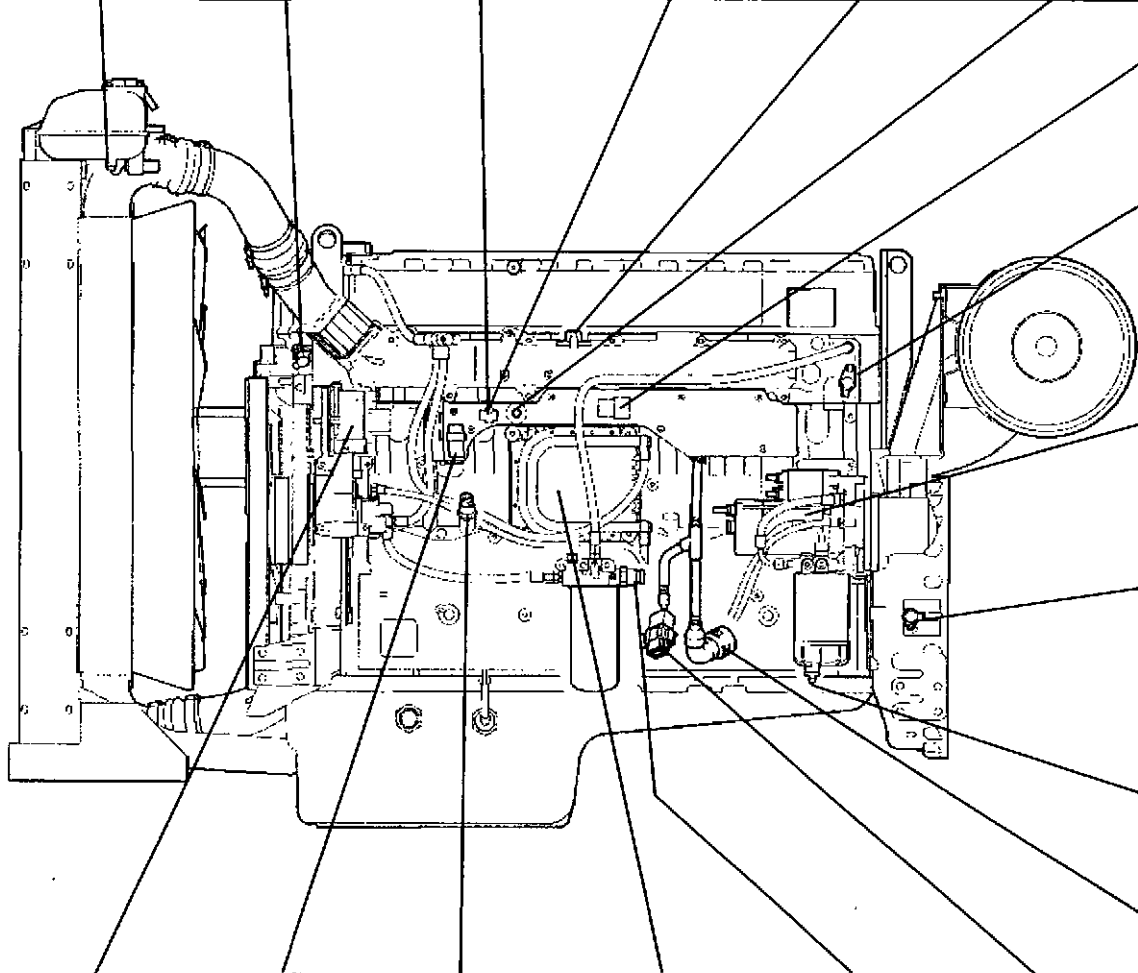
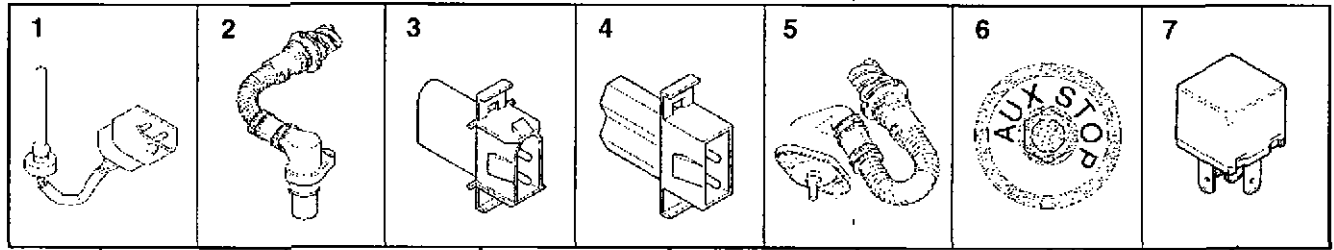

- | | | | |
|-----|---|-----|----------------------------|
| 1. | Coolant level monitor | 11. | Control unit |
| 2. | Speed sensor, camshaft | 12. | Fuel pressure monitor |
| 3. | Connector, diagnostic tool | 13. | 8-pin connection |
| 4. | Programming plug | 14. | 23-pin connection |
| 5. | Charge pressure / Charge temperature sensor | 15. | Coolant temperature sensor |
| 6. | Extra stop | 16. | Starter motor |
| 7. | Main relay | 17. | Starter motor relay |
| 8. | Alternator | 18. | Speed sensor, flywheel |
| 9. | Fuse 10 A | 19. | Water monitor, fuel filter |
| 10. | Oil pressure / Oil temperature sensor | | |

System voltage 24 V

NOTE! All engines are equipped with a 2-pole electrical system. This means that the positive and negative cables from the battery must be connected to the starter motor terminals.

The positive cable from the battery must be connected via a main switch to terminal 30 on the starter motor. The negative cable from the battery must be connected directly terminal 31 on the starter motor.

Battery specification

Max. battery 143Ah, 570A DIN

Battery charging

Standard practice on all engines is that the batteries are provided with power from the alternator.

Battery cable area

The total length (L) of the positive and negative cables determines the area (A) of the cables.

Max L (m)	2	3	4	4,5	6	7
Min A (mm ²)	70	95	120	2x70	2x95	2x120

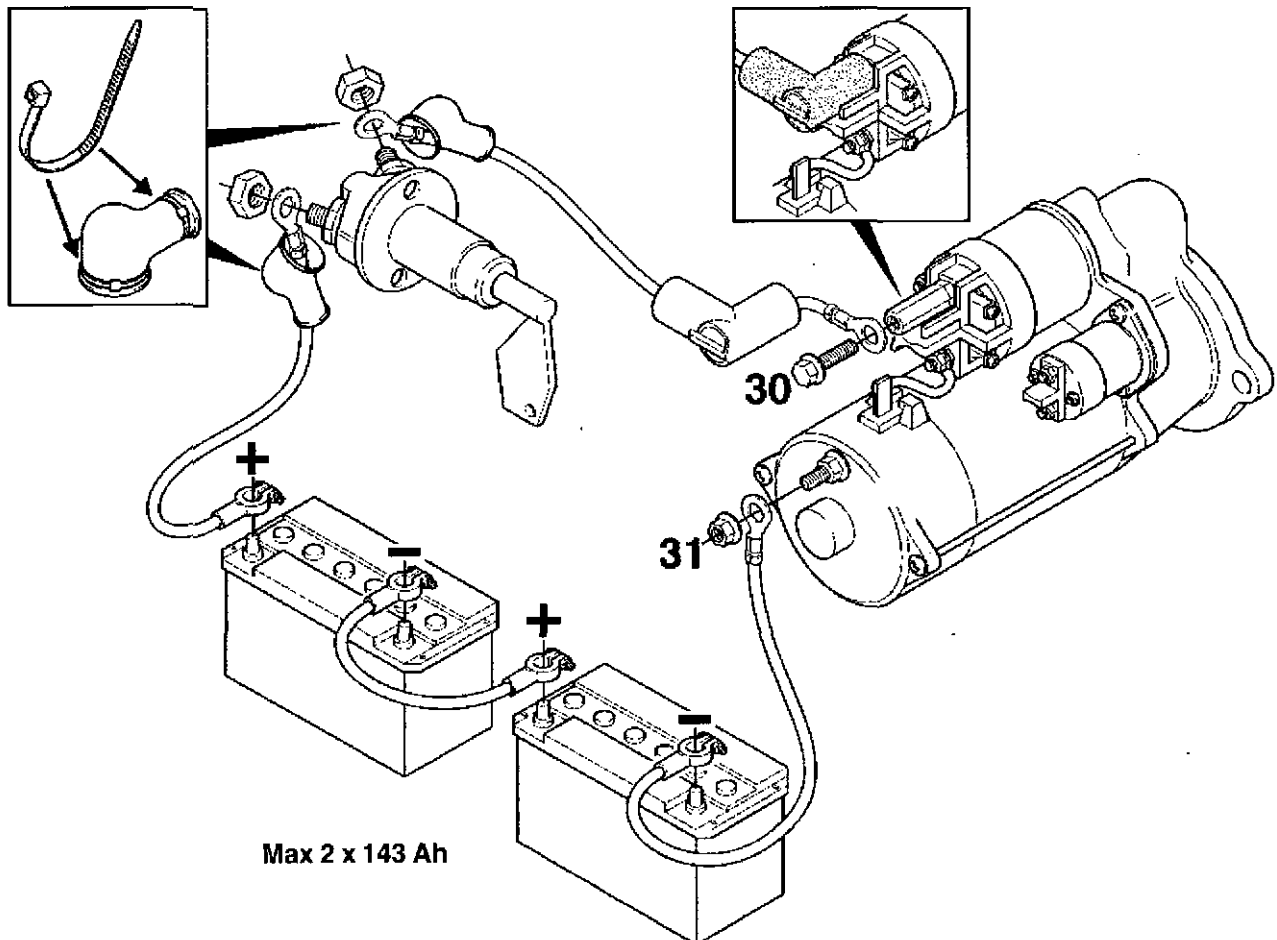

TAD1240-42GE (Standalone)

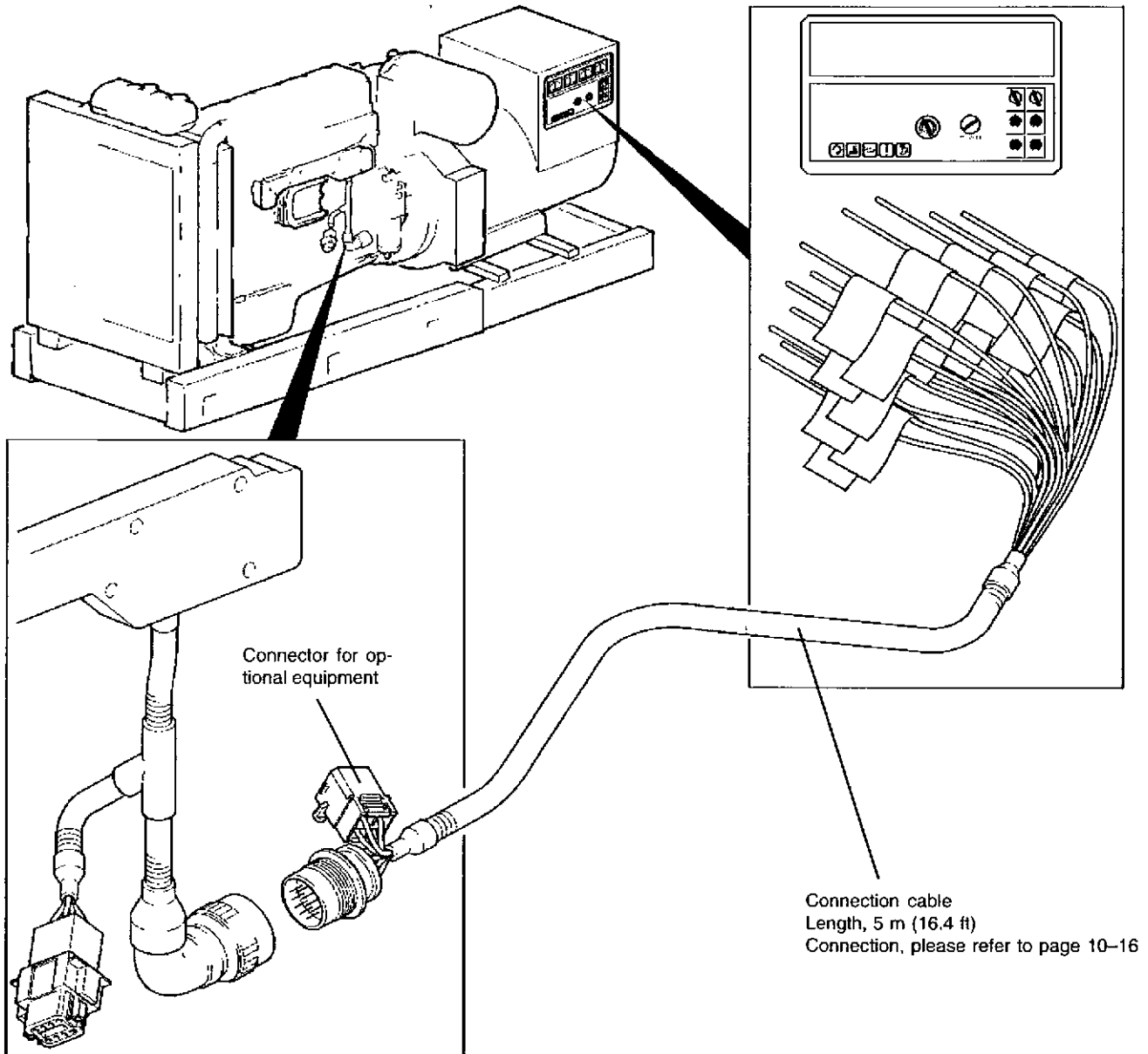

General information

The installation must be planned very thoroughly and done with the greatest care.

The connection cable between the engine and the instrument panel must be securely clamped. Remember that the connectors must also be supported so that they are not subjected to any tension.

Cables must not be run too close to hot components on the engine or close to any other source of heat. Make sure that it is protected from mechanical wear, sharp edges and water splashes. If necessary, run the cable through protective conduits.

Avoid making joints in the system as far as possible. Cables and any joints must be accessible for inspection and service

NOTE! The connectors must be installed "dry", they must not be packed with Vaseline etc.

Connector for optional equipment

The connection cable is provided with four extra conductors for connection of instrument sensors etc.

The four-pin connector is marked "Extra". The four cables are marked "T", "U", "V" and "W".

Connection

Engine management

(please refer to wiring diagram on page 16)

Starter switch

(system voltage ON / OFF)

NOTE! The starting current for engine system voltage (control unit) is 10 A. Make sure that other components in the installation are dimensioned for this current density.

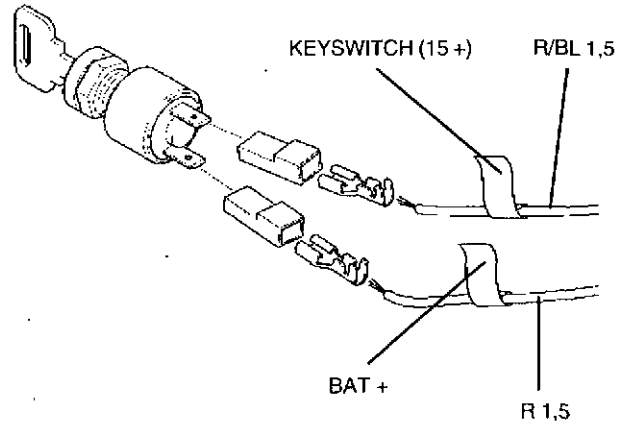

Start switch

Contact type, closing (NO), spring biased.

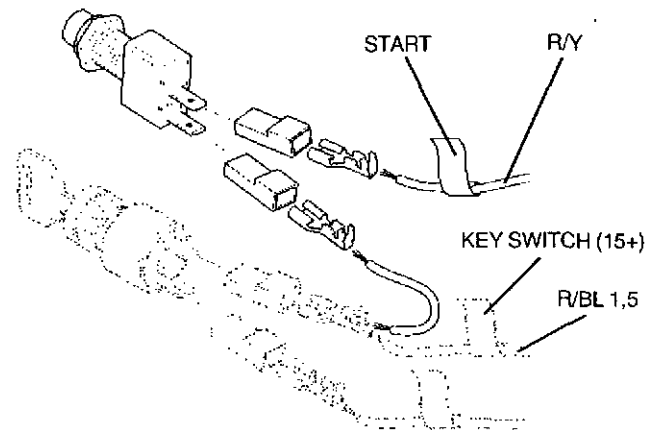

Stop switch

Contact type, opening (NC), spring biased

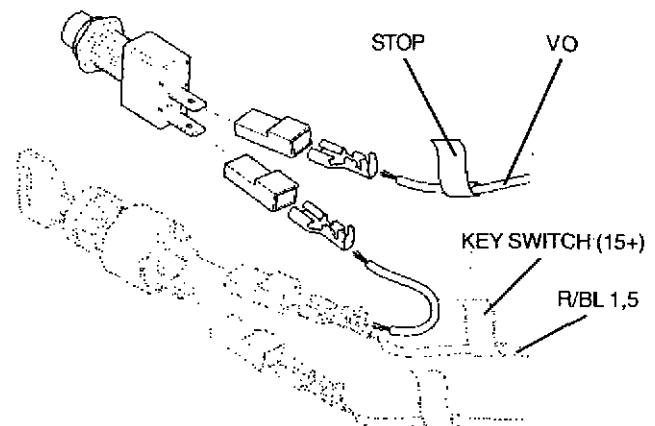

Engine speed potentiometer

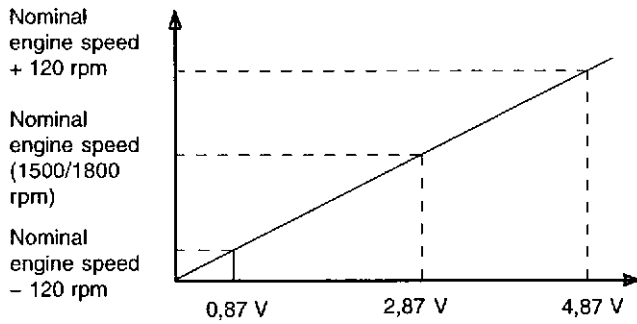
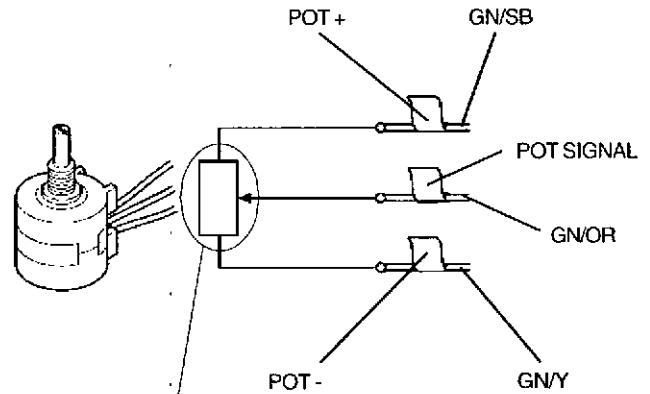

Voltages lower than 0.87 V, or higher than 4.87 V are not permissible.

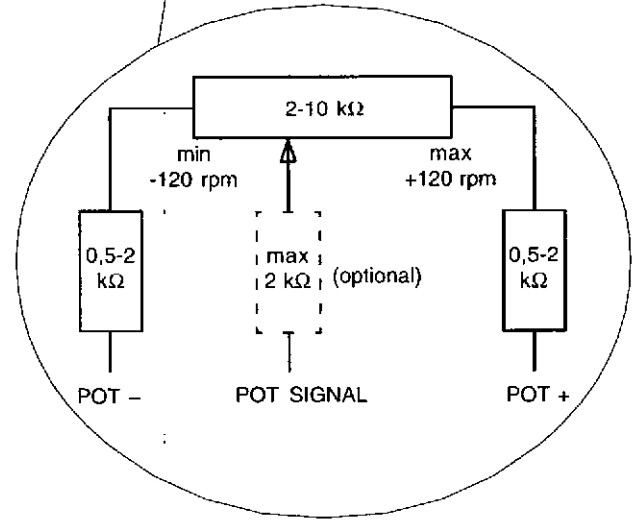

1500 / 1800 rpm switch

This function permits frequency to be changed from 50 to 60 Hz.

Contact type, two-position (NO).

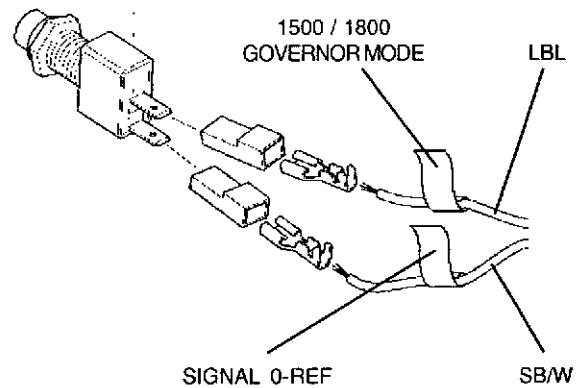

Idling terminal

Contact type, two-position (NO).

Closed contact gives idling speed (900 rpm).

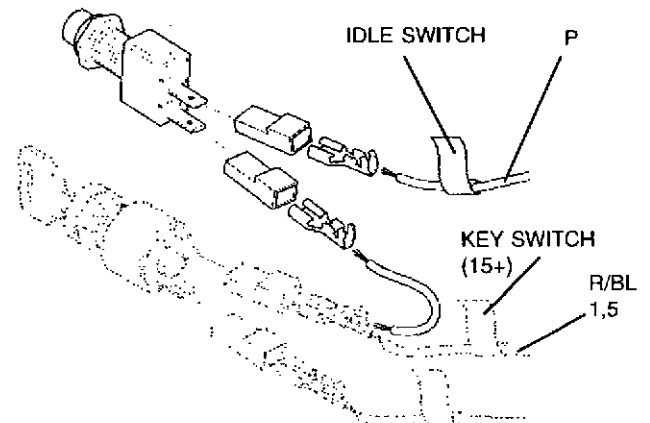

Warning and indication lamps

(please refer to wiring diagram on page 16)

Alarm, low oil pressure

Max. power 3 W

Voltage 24 V

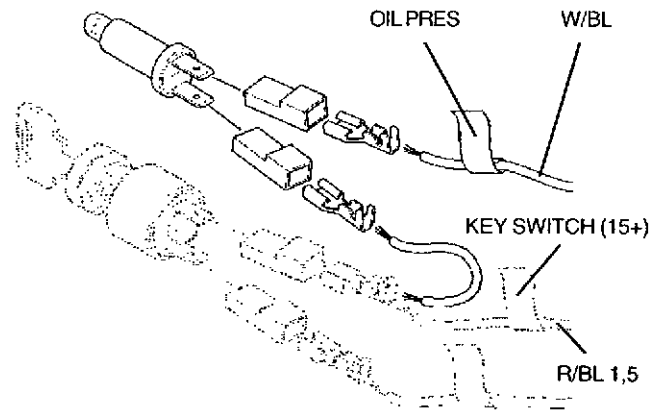

Alarm, high coolant temperature

Max. power 3 W

Voltage 24 V

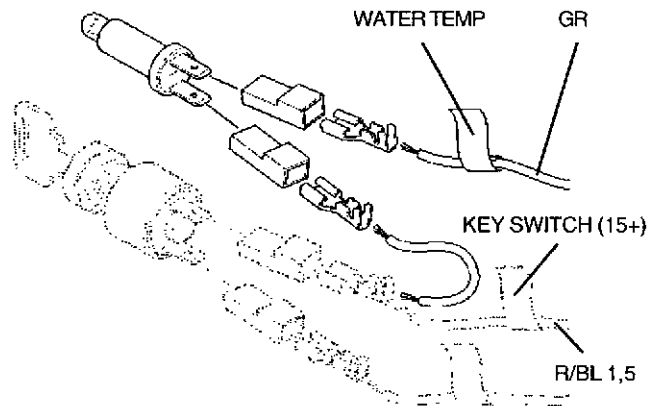

Operation indication

Max. power 3 W

Voltage 24 V

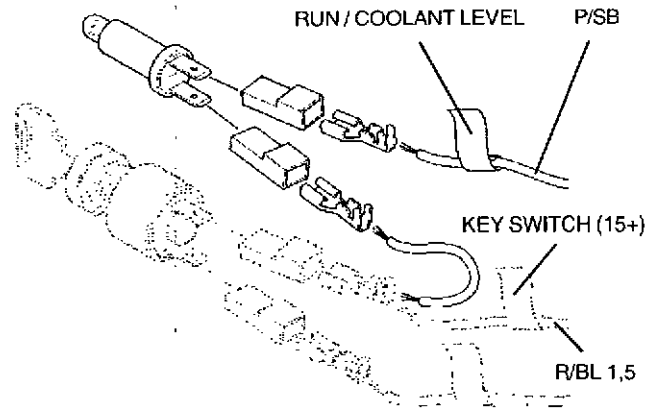

Alarm, over-speed

Max. power 3 W

Voltage 24 V

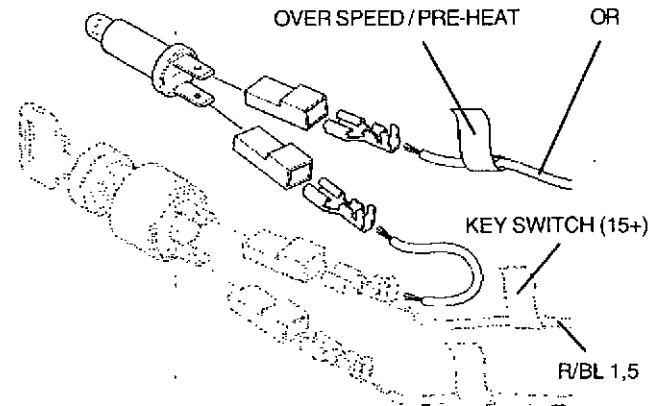

Diagnostic lamp

Max. power 3 W

Voltage 24 V

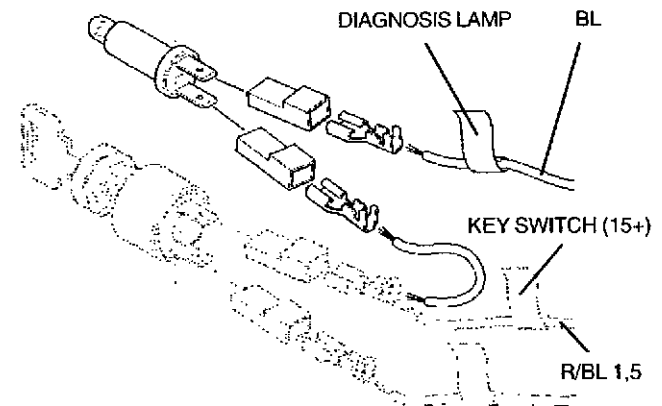

Other

(please refer to wiring diagram on page 16)

Diagnostic connector

Contact type, closing (NO), spring biased.

To read the fault codes, please refer to chapter "Fault tracing".

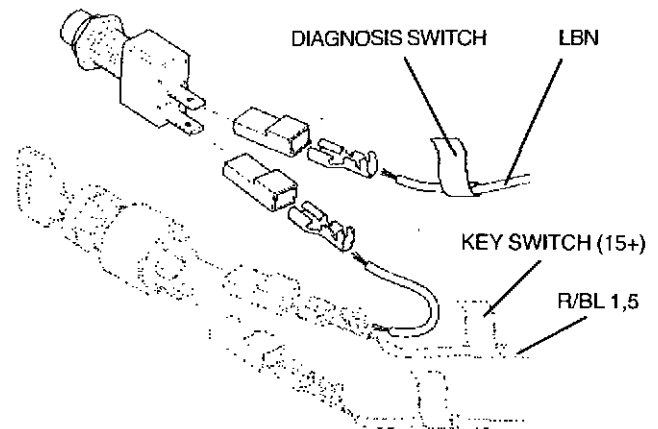

Pre-heating switch

NOTE! Preheating function not used on TAD1240-42GE.

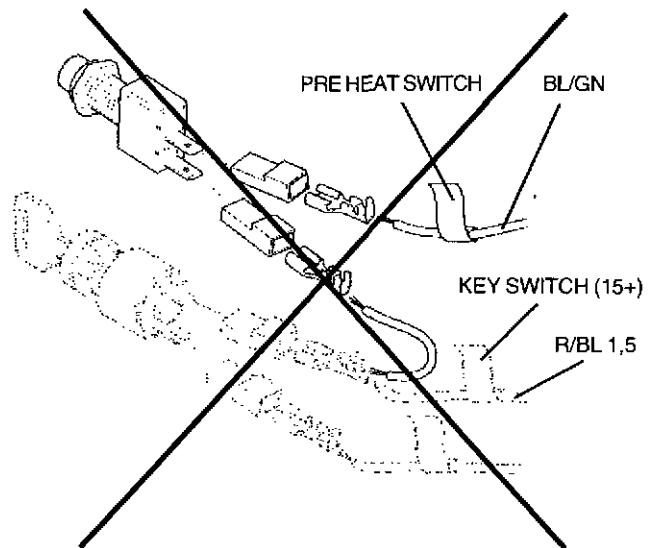

Synchronization/load distribution

The system is designed to suit the GAC synchronization and load distribution system. Interface module EAM 122 must be used to connect this system.

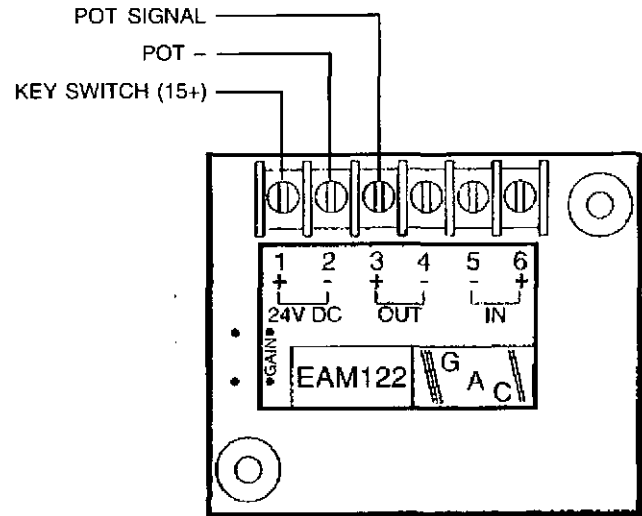

System reset

A system reset is used to delete fault codes which occurred during installation. For example, an incorrectly connected warning lamp will generate a fault code if it is removed when system voltage is switched on. This fault code is erased if a system reset is done and the lamp will be identified with its correct function.

A system reset restores, identifies and stores the current system configuration.

NOTE! Always finish off an engine installation by doing a system re-set.

A system reset must also be done after a frequency change.

Procedure

1. Press the "Diagnostic button" and keep it depressed when system voltage is switched on. Keep it depressed for 2-3 seconds after system voltage has been switched on.

The engine is now in "system reset mode".

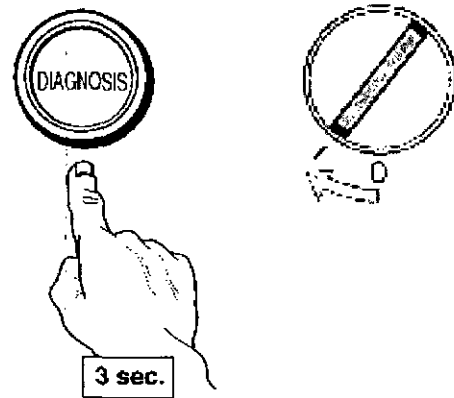

2. The system reset is completed by switching system voltage off.

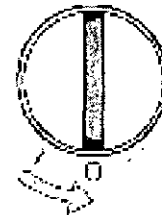

Wiring diagram

TAD1240-42GE (24 V system voltage, 2-pole)

1. Engine speed potentiometer
2. 1500 / 1800 rpm switch
3. Start switch
4. Idling terminal
5. Stop switch
6. Diagnosis
7. Alarm, low oil pressure
8. Alarm, high coolant temperature
9. Indication, engine running
10. Alarm, over-speed
11. Voltage after key
12. Battery negative
13. Battery positive
14. Key switch
15. J1587 (bus)
16. J1939 CAN (bus)
17. Battery negative
18. Battery positive
19. Voltage after key
20. Connector
21. Programming connector
22. Diode
23. Monitor, water in fuel
24. Relay socket
25. Main relay
26. Monitor, fuel pressure
27. Monitor, coolant level
28. Stop
29. Programming plug
30. Connector (2) (red)
31. Connector (1) (black)
32. Control unit EDC III
33. Unit injector
34. Coolant temperature sensor
35. Charge air temperature/pressure sensor
36. Preheat function is NOT available for TAD1240-42GE
37. Sensor, camshaft (rpm)
38. Sensor, flywheel (rpm)
39. Alternator
40. Starter motor
41. Oil temperature/pressure sensor
42. Battery (24 V)
43. Stand Alone Connector
44. Data bus connector

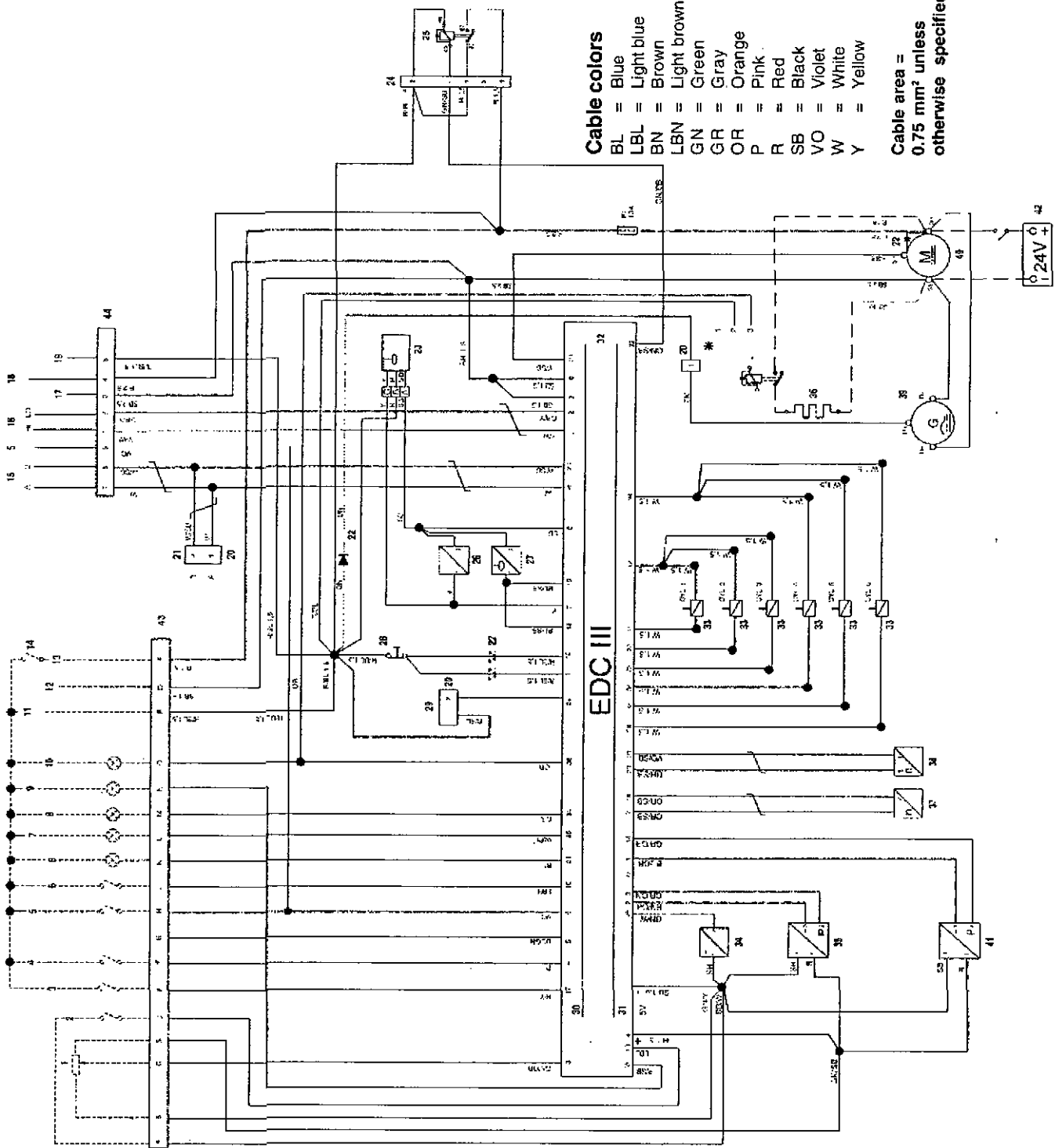

Cable colors

- BL = Blue
- LBL = Light blue
- BN = Brown
- LBN = Light brown
- GN = Green
- GR = Gray
- OR = Orange
- P = Pink
- R = Red
- SB = Black
- VO = Violet
- W = White
- Y = Yellow

Cable area =
0.75 mm² unless
otherwise specified.

Parameter setting

Connection, parameter tool

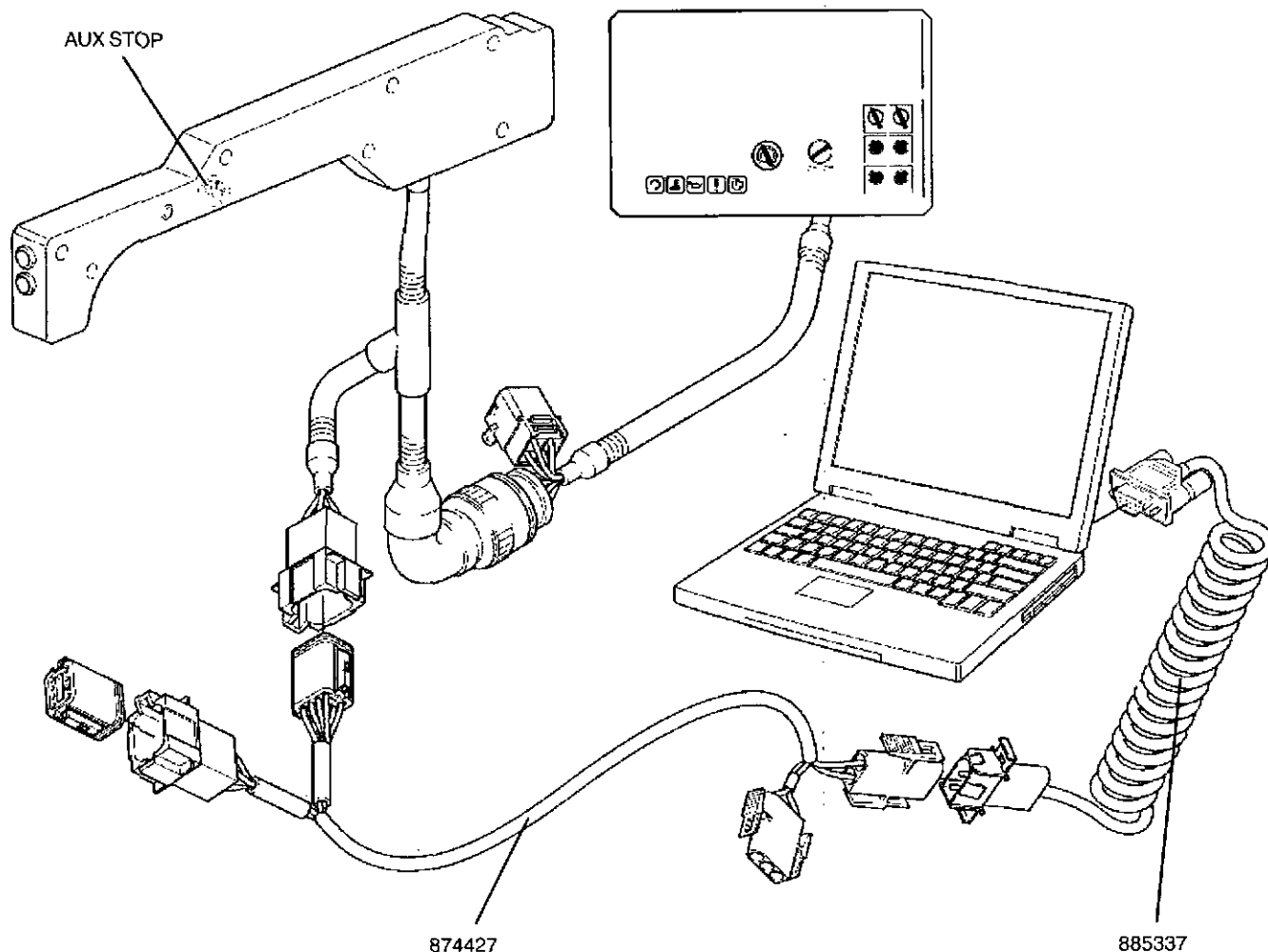

Operation

Connect your laptop as above. Use T-piece, part no. 874427 and communication cable part no. 885337.

Install the "Parameter setting tool" software.

Switch the ignition (do **not** start the engine)

Start the parameter setting tool and follow the instructions in the accompanying manual.

The tool shows the parameters which can be connected on that engine, also see the next page.

NOTE! Finish programming by switching off the ignition with the "AUX STOP" button.

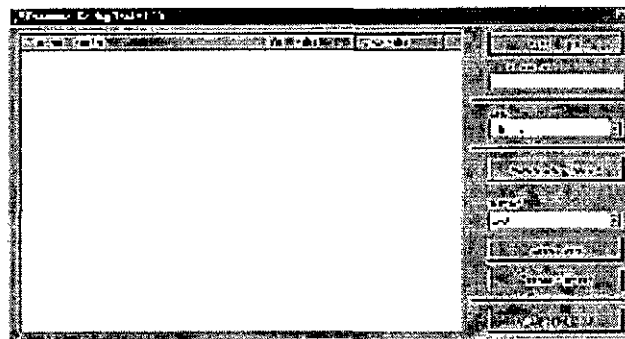

Adjustable parameters TAD1240-42GE (Standalone)

NOTE! Some parameters require special authorization.

Regulation droop

Selects the amount of droop to be used (percent).

Min. value	0 %
Default value	0 %
Max. value	8 %

Alarm limit for oil temperature

The warning lamp is lit at this temperature.

Min. value	120 °C (248 °F)
Default value	125 °C (257 °F)
Max. value	130 °C (266 °F)

Lamp test

This parameter selects whether a lamp test should be done when the system starts up.

Alternative positions "Off" or "On"
Default value "On"

Over-speed limit

Percentage above normal speed when the over-speed warning is activated.

Min. value	10 %
Default value	20 %
Max. value	20 %

Over-speed shut off

Parameter which selects whether the engine should be stopped if it overspeeds.

Alternative positions "Off" or "On"
Default value "Off"

Alarm limit for coolant temperature

The warning lamp is lit at this temperature.

Min. value	95 °C (203 °F)
Default value	98 °C (208 °F)
Max. value	101 °C (214 °F)

Idling speed.

Setting idling speed

Min. value	600 rpm
Default value	900 rpm
Max. value	1200 rpm

Stop EMS: connected to system voltage at

Stop input on EMS unit connected to system voltage at "Run" or "Stop".

Default value "Run"

Engine protection charge air temperature

Chooses whether engine protection should be activated in relation to high charge air temperature.

Alternative positions "Off" or "On"
Default value "On"

Engine protection coolant level

Chooses whether engine protection should be activated in relation to low coolant level.

Alternative positions "Off" or "On"
Default value "On"

Engine protection coolant temperature

Chooses whether engine protection should be activated in relation to high coolant temperature.

Alternative positions "Off" or "On"
Default value "On"

Engine protection oil pressure

Chooses whether engine protection should be activated in relation to low oil pressure.

Alternative positions "Off" or "On"
Default value "On"

Engine protection oil temperature

Chooses whether engine protection should be activated in relation to high oil temperature.

Alternative positions "Off" or "On"
Default value "On"

Primary engine speed

Selects the engine speed to be used when the frequency setting switch is not used.

Alternative speed	1500 rpm or 1800 rpm
Default speed	Depending on the specification ordered.

NOTE! After the primary speed is changed, a system reset must also be done, please refer to the "System reset" chapter.

TAD1240-42GE (CIU)

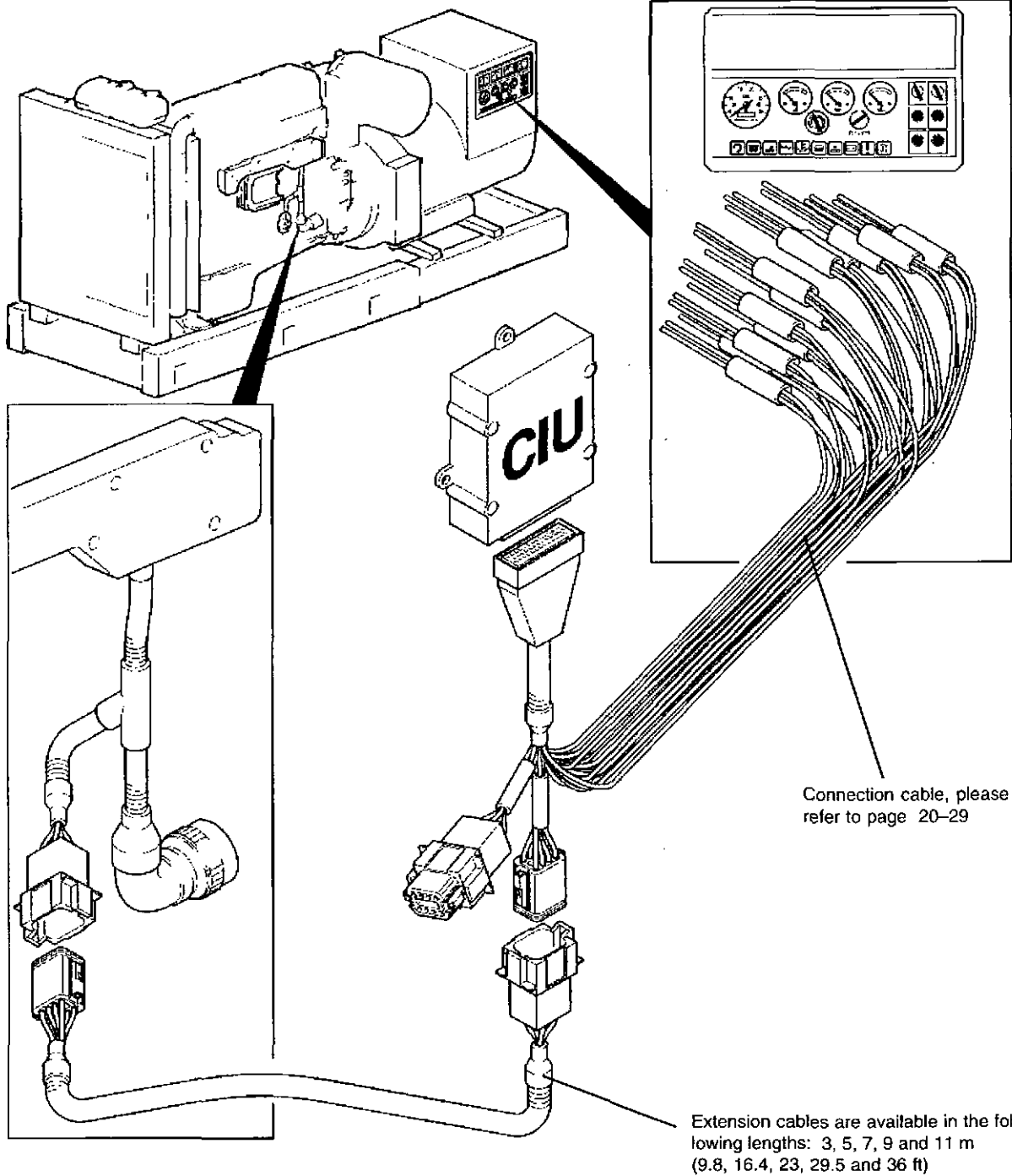

General information

The installation must be planned very thoroughly and done with the greatest care.

The connection cable between the engine and the instrument panel must be securely clamped. Remember that the connectors must also be supported so that they are not subjected to any tension.

Cables must not be run too close to hot components on the engine or close to any other source of heat. Make sure that it is protected from mechanical wear,

sharp edges and water splashes. If necessary, run the cable through protective conduits.

Avoid making joints in the system as far as possible. Cables and any joints must be accessible for inspection and service

NOTE! The connectors must be installed "dry", they must not be packed with Vaseline etc.

Connection

Engine management

(please refer to wiring diagram on page 29)

Starter switch (system voltage ON / OFF)

NOTE! The starting current for engine system voltage (control unit) is 10 A. Make sure that other components in the installation are dimensioned for this current density.

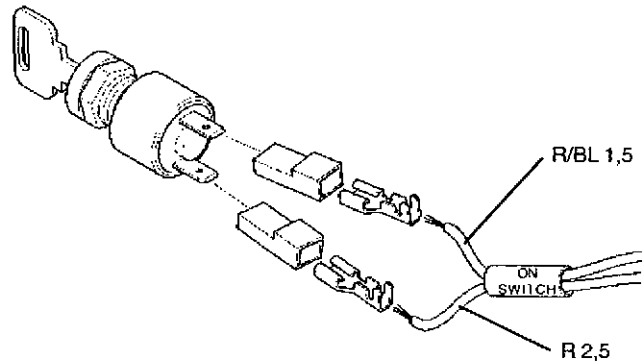

Start switch

Contact type, closing (NO), spring biased.

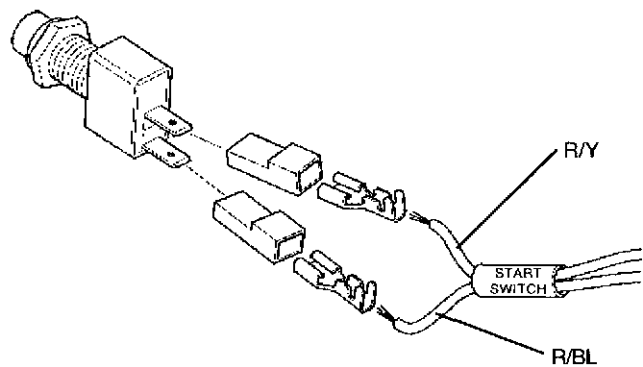

Stop switch

Contact type, closing (NO), spring biased.

When parameters are chosen, live during operation can be chosen.

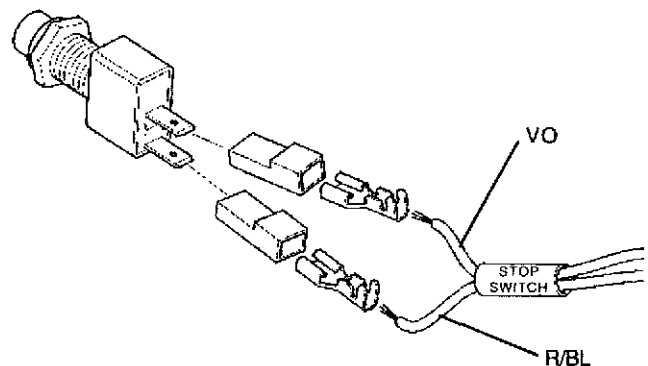

Engine speed potentiometer

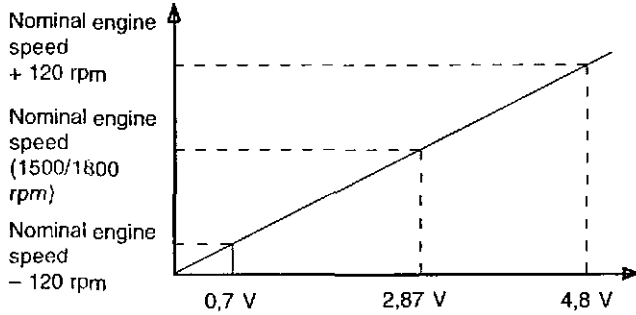
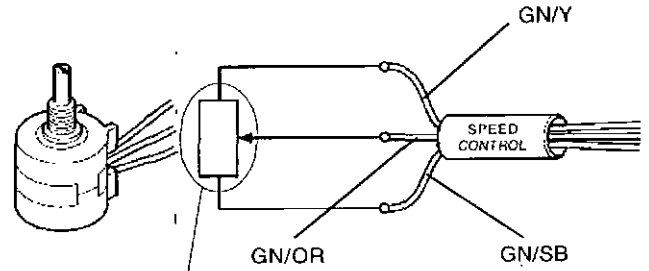

Voltages lower than 0.7 V, or higher than 4.8 V are not permissible.

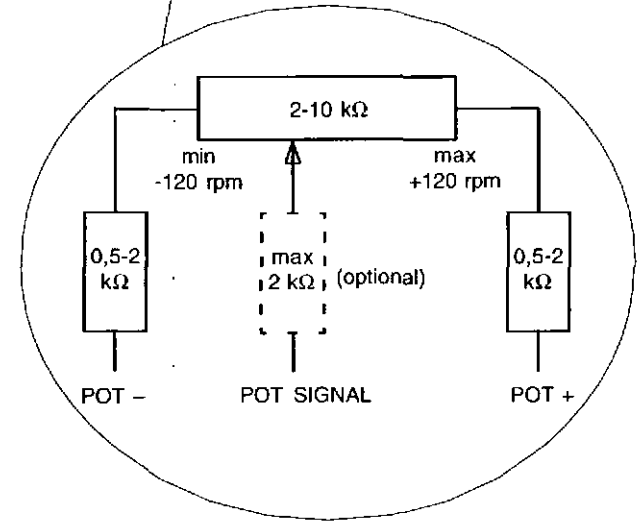

1500 / 1800 rpm switch

This function permits frequency to be changed from 50 to 60 Hz.

Contact type, two-position (NO).

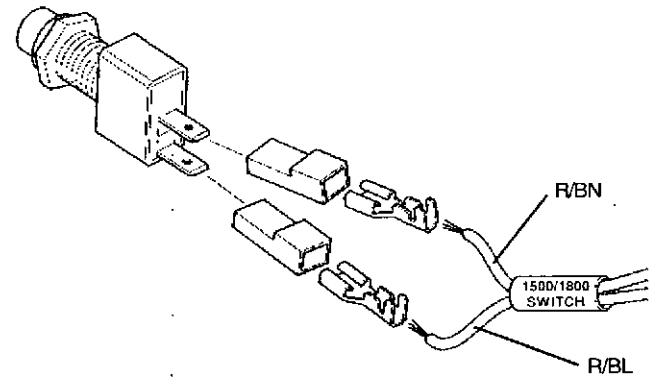

Idling button

Contact type, two-position (NO).

Closed contact gives idling speed (900 rpm).

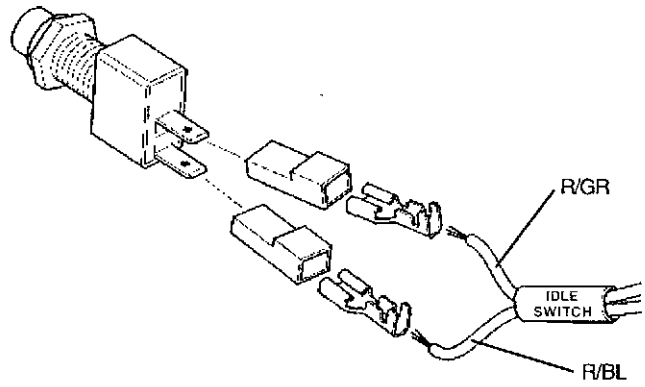

Regulator connector

NOTE! This preheating function not used on the TAD1240-42GE.

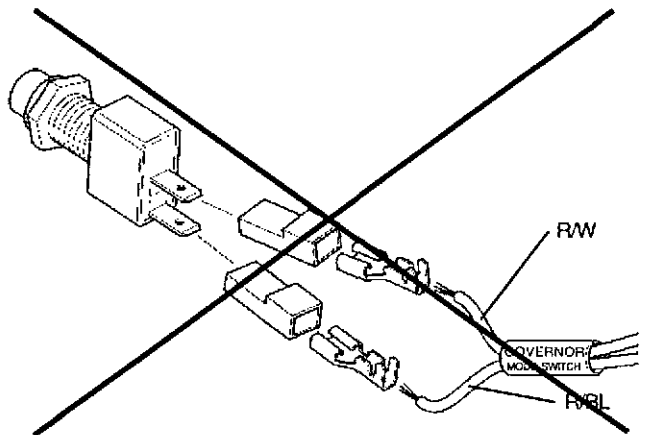

Warning and indication lamps

(please refer to wiring diagram on page 29)

Alarm, low oil pressure

Max. power 3 W

Voltage 24 V

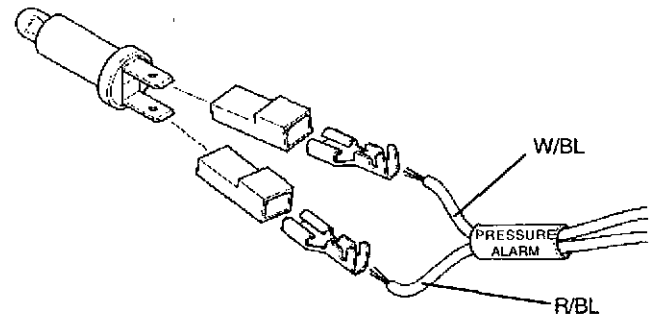

Alarm, high oil temperature

Max. power 3 W

Voltage 24 V

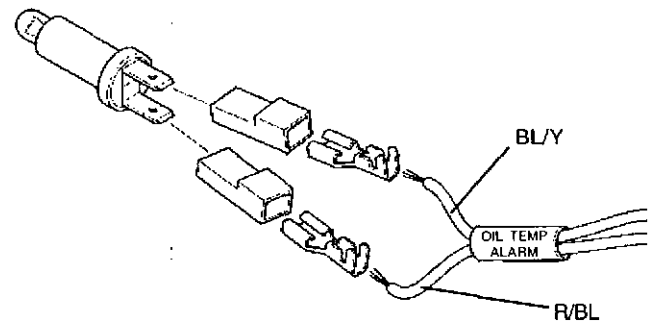

Alarm, high coolant temperature

Max. power 3 W

Voltage 24 V

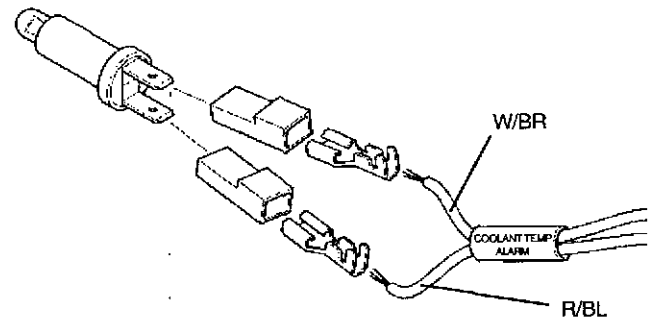

Alarm, low coolant level

Max. power 3 W

Voltage 24 V

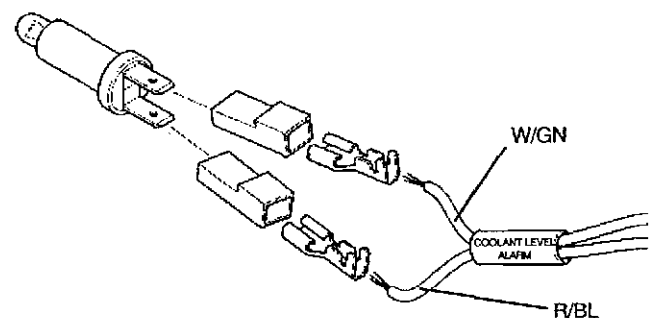

Fuel alarm

Max. power 3 W

Voltage 24 V

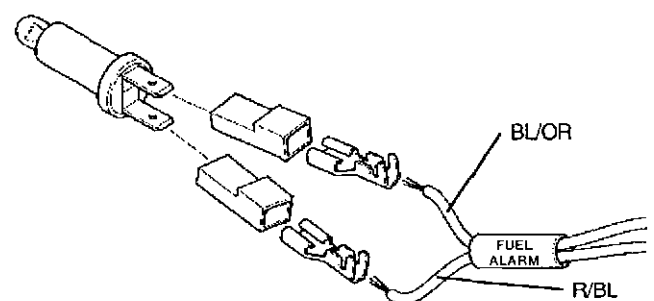

Charge indication

Max. power 3 W
Voltage 24 V

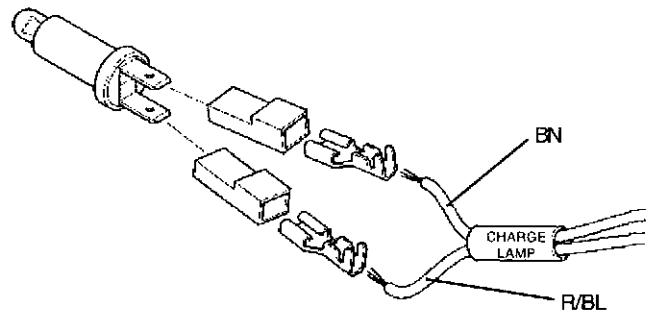

Overspeed indication

Max. power 3 W
Voltage 24 V

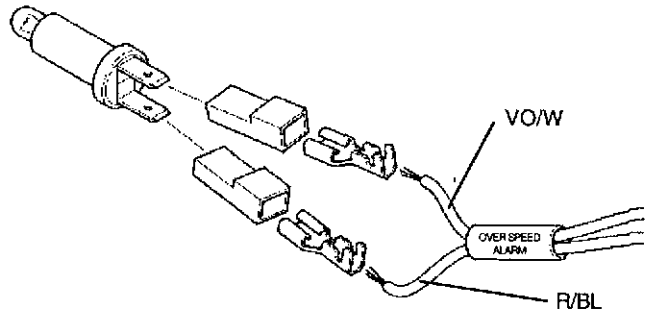

Operation indication

Max. power 3 W
Voltage 24 V

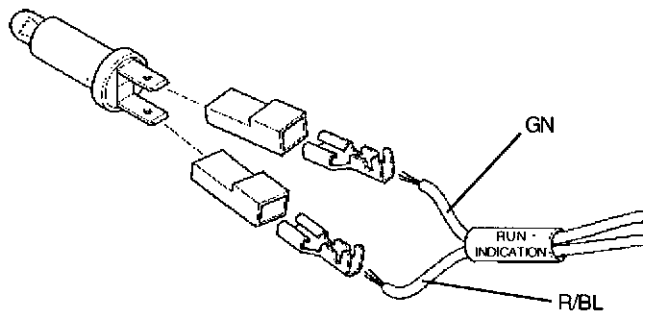

Diagnostic lamp

Max. power 3 W
Voltage 24 V

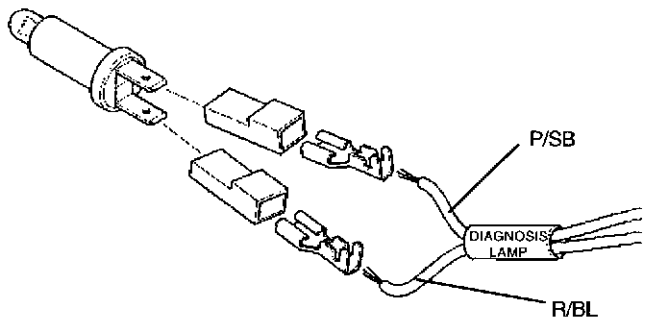

Pre-heating indication

NOTE! Preheating **not** connected on TAD1240-42GE.

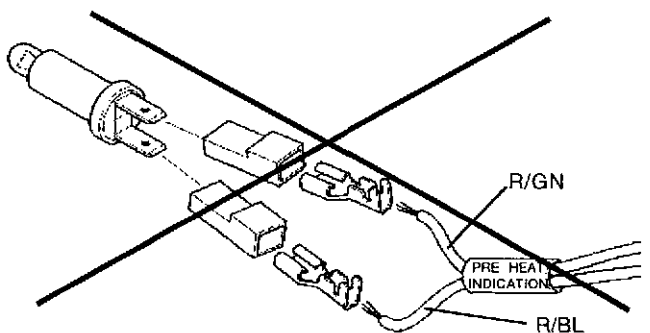

Instruments

(please refer to wiring diagram on page 29)

Tachometer

Use Volvo Penta's (VDO) universal tachometer, graduated 0-2600 rpm.

Set code 14, please refer to installation instruction 7739513-5.

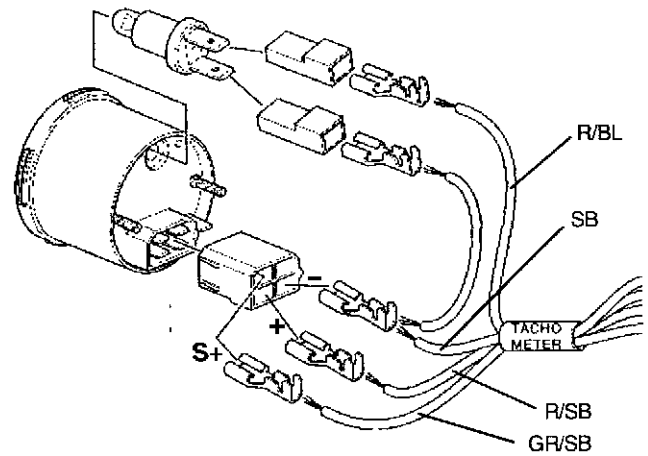

Oil pressure instrument

Use Volvo Penta's (VDO) oil pressure instrument, graduated 0-10 bar (0-145 PSI).

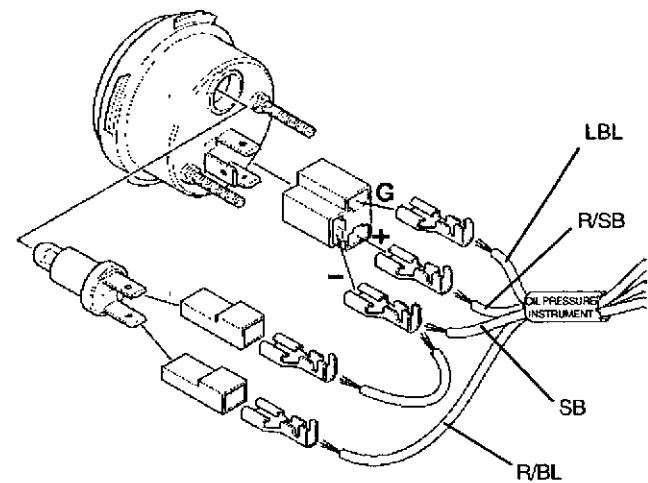

Oil temperature instrument

Use Volvo Penta's (VDO) oil temperature instrument, graduated 40-150 °C (104-302 °F).

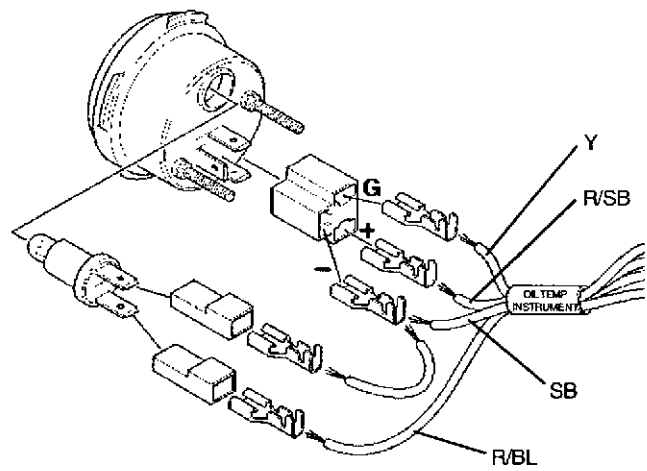

Coolant temperature instrument

Use Volvo Penta's (VDO) coolant temperature instrument, graduated 40-120°C (104-248 °F).

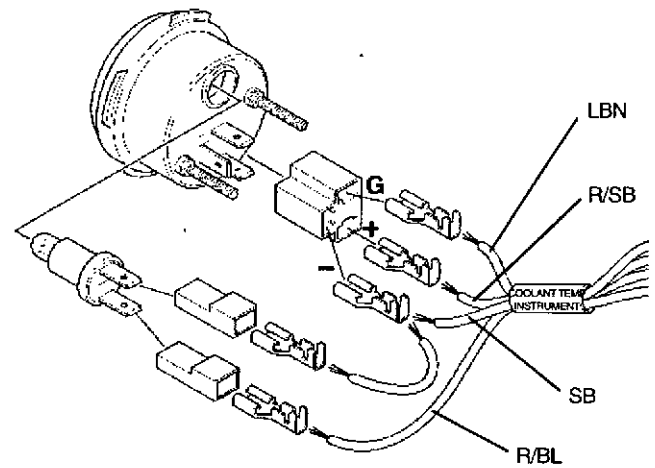

Other

(please refer to wiring diagram on page 29)

Diagnostic connector

Contact type, closing (NO), spring biased.

To read the fault codes, please refer to chapter "Fault tracing".

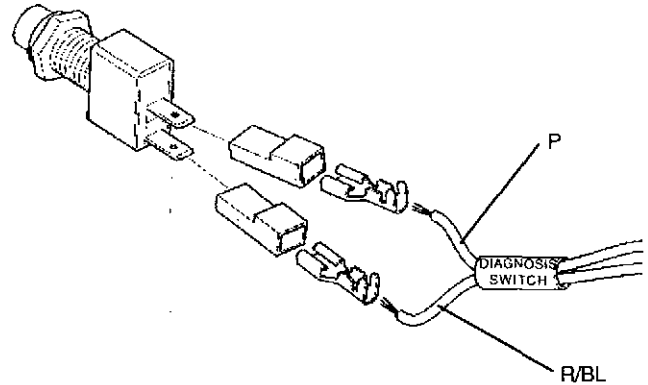

Pre-heating switch

NOTE! Preheating **not** connected on TAD1240-42GE.

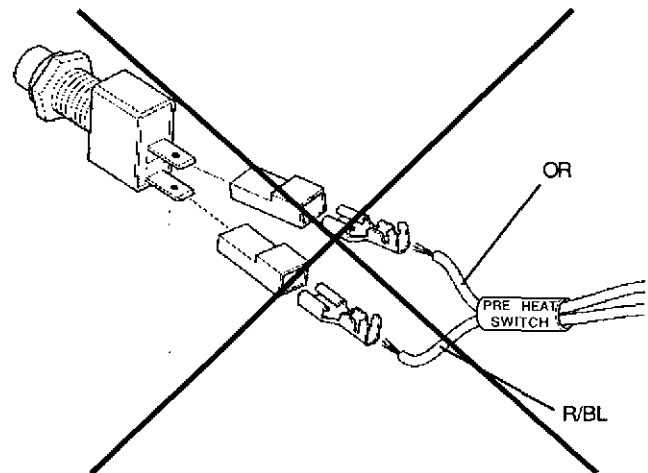

Synchronization/load distribution

The system is designed to suit the GAC synchronization and load distribution system. Interface module EAM 122 must be used to connect this system.

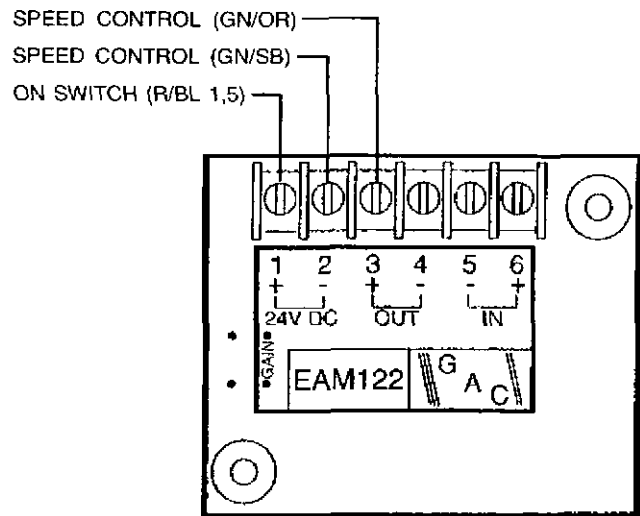

System reset

A system reset is used to delete fault codes which occurred during installation. For example, an incorrectly connected warning lamp will generate a fault code if it is removed when system voltage is switched on. This fault code is erased if a system reset is done and the lamp will be identified with its correct function.

A system reset restores, identifies and stores the current system configuration.

NOTE! Always finish off an engine installation by doing a system re-set.

NOTE! A system reset must also be done after a frequency change.

Procedure

1. Press the "Diagnostic button" and keep it depressed when system voltage is switched on. Keep it depressed for 2-3 seconds after system voltage has been switched on.

The engine is now in "system reset mode".

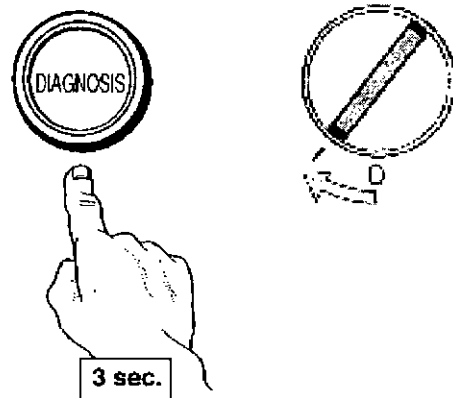

2. The system reset is completed by switching system voltage off.

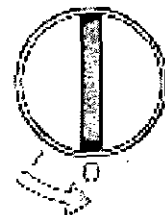

Wiring diagram

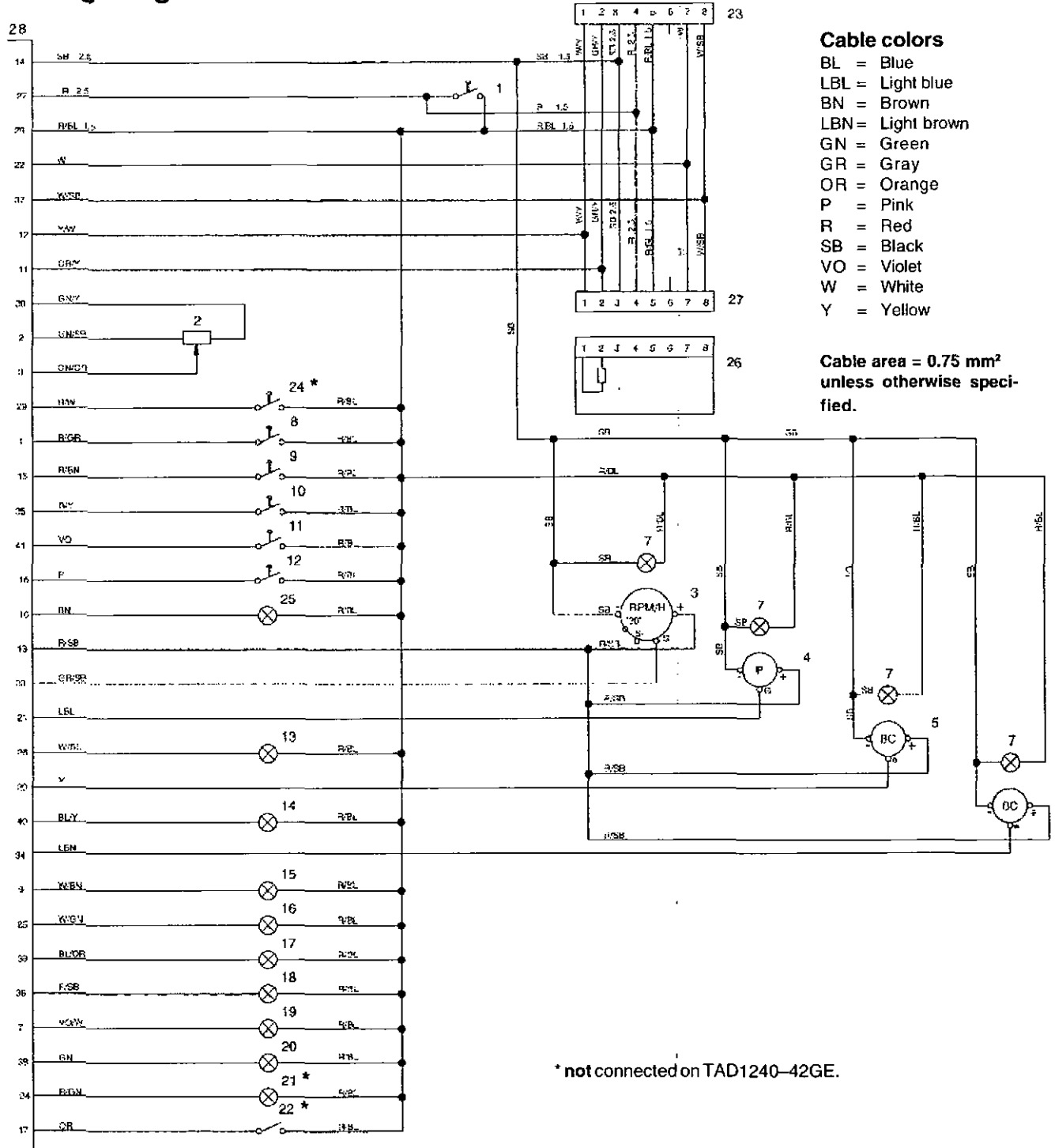

Wiring diagram, control interface unit (CIU)

- | | |
|---|---|
| <ol style="list-style-type: none"> 1. Key switch, driving current (15+) 2. Engine speed potentiometer 3. Tachometer (code 14) 4. Oil pressure, instrument 5. Oil temperature, instrument 6. Coolant temperature, instrument 7. Instrument lighting 8. Idling contact, two-way 9. 1500 / 1800 rpm switch, two-way 10. Starter contact, spring biased 11. Stop switch, spring biased 12. Diagnostic contact, spring biased 13. Alarm, low oil pressure 14. Alarm, high oil temperature 15. Alarm, high coolant temperature 16. Alarm, low coolant level | <ol style="list-style-type: none"> 17. Fuel alarm 18. Diagnostic lamp 19. Overspeed indication 20. Operation indication 21. Preheating indication (not connected on TAD1240-42GE) 22. Preheating contact (not connected on TAD1240-42GE) 23. 8-pin Deutsch connector, pin 24. Regulator switch (not connected on TAD1240-42GE) 25. Charge indication 26. Termination resistor 120 Ohm 27. 8-pin Deutsch connector, socket 28. Control Interface Unit (CIU) |
|---|---|

* not connected on TAD1240-42GE.

Parameter setting

Connection, parameter tool

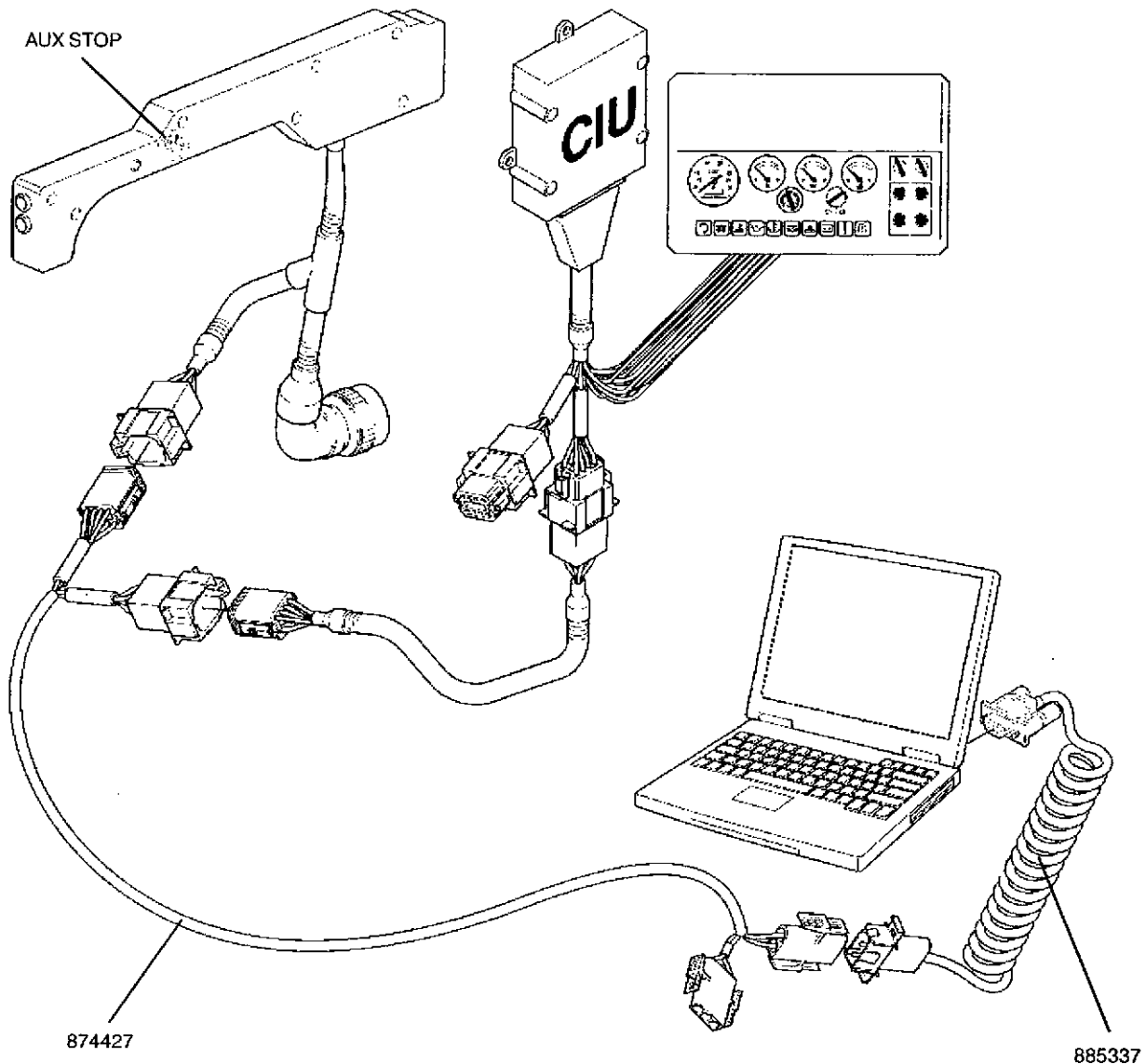

Operation

Connect your laptop as above. Use T-piece, part no. 874427 and communication cable part no. 885337.

Install the "Parameter setting tool" software.

Switch the ignition (do **not** start the engine)

Start the parameter setting tool and follow the instructions in the accompanying manual.

The tool shows the parameters which can be connected on that engine, also see the next page.

NOTE! Finish programming by switching off the ignition with the "AUX STOP" button.

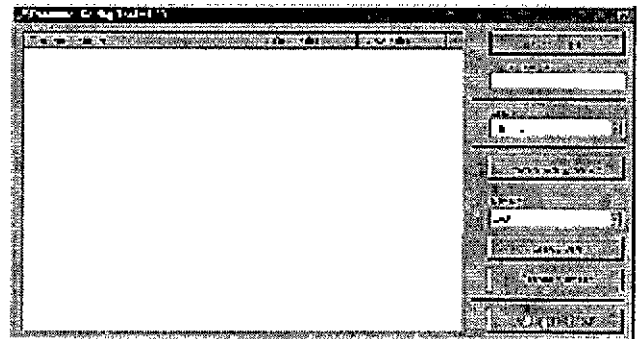

Adjustable parameters TAD1240-42GE (CIU)

NOTE! Some parameters require special authorization.

Regulation droop

Selects the amount of droop to be used (percent).

Min. value	0 %
Default value	0 %
Max. value	8 %

Stop CIU: connected to system voltage at

Stop input on CIU unit connected to system voltage at "Run" or "Stop".

Default value	"Stop"
---------------	--------

Alarm limit for oil temperature

The warning lamp is lit at this temperature.

Min. value	120 °C (248 °F)
Default value	125 °C (257 °F)
Max. value	130 °C (266 °F)

Lamp test

This parameter selects whether a lamp test should be done when the system starts up.

Alternative positions "Off" or "On"
Default value "On"

Over-speed limit

Percentage above normal speed when the over-speed warning is activated.

Min. value	10 %
Default value	20 %
Max. value	20 %

Over-speed shut off

Parameter which selects whether the engine should be stopped if it overspeeds.

Alternative positions "Off" or "On"
Default value "Off"

Alarm limit for coolant temperature

The warning lamp is lit at this temperature.

Min. value	95 °C (203 °F)
Default value	98 °C (208 °F)
Max. value	101 °C (214 °F)

Idling speed.

Setting idling speed

Min. value	600 rpm
Default value	900 rpm
Max. value	1200 rpm

Engine protection charge air temperature

Chooses whether engine protection should be activated in relation to high charge air temperature.

Alternative positions "Off" or "On"
Default value "On"

Engine protection coolant level

Chooses whether engine protection should be activated in relation to low coolant level.

Alternative positions "Off" or "On"
Default value "On"

Engine protection coolant temperature

Chooses whether engine protection should be activated in relation to high coolant temperature.

Alternative positions "Off" or "On"
Default value "On"

Engine protection oil pressure

Chooses whether engine protection should be activated in relation to low oil pressure.

Alternative positions "Off" or "On"
Default value "On"

Engine protection oil temperature

Chooses whether engine protection should be activated in relation to high oil temperature.

Alternative positions "Off" or "On"
Default value "On"

Primary engine speed

Selects the engine speed to be used when the frequency setting switch is not used.

Alternative speed	1500 rpm or 1800 rpm
Default speed	Depending on the specification ordered.

NOTE! After the primary speed is changed, a system reset must also be done, please refer to the "System reset" chapter.

TWD1240VE (Standalone)

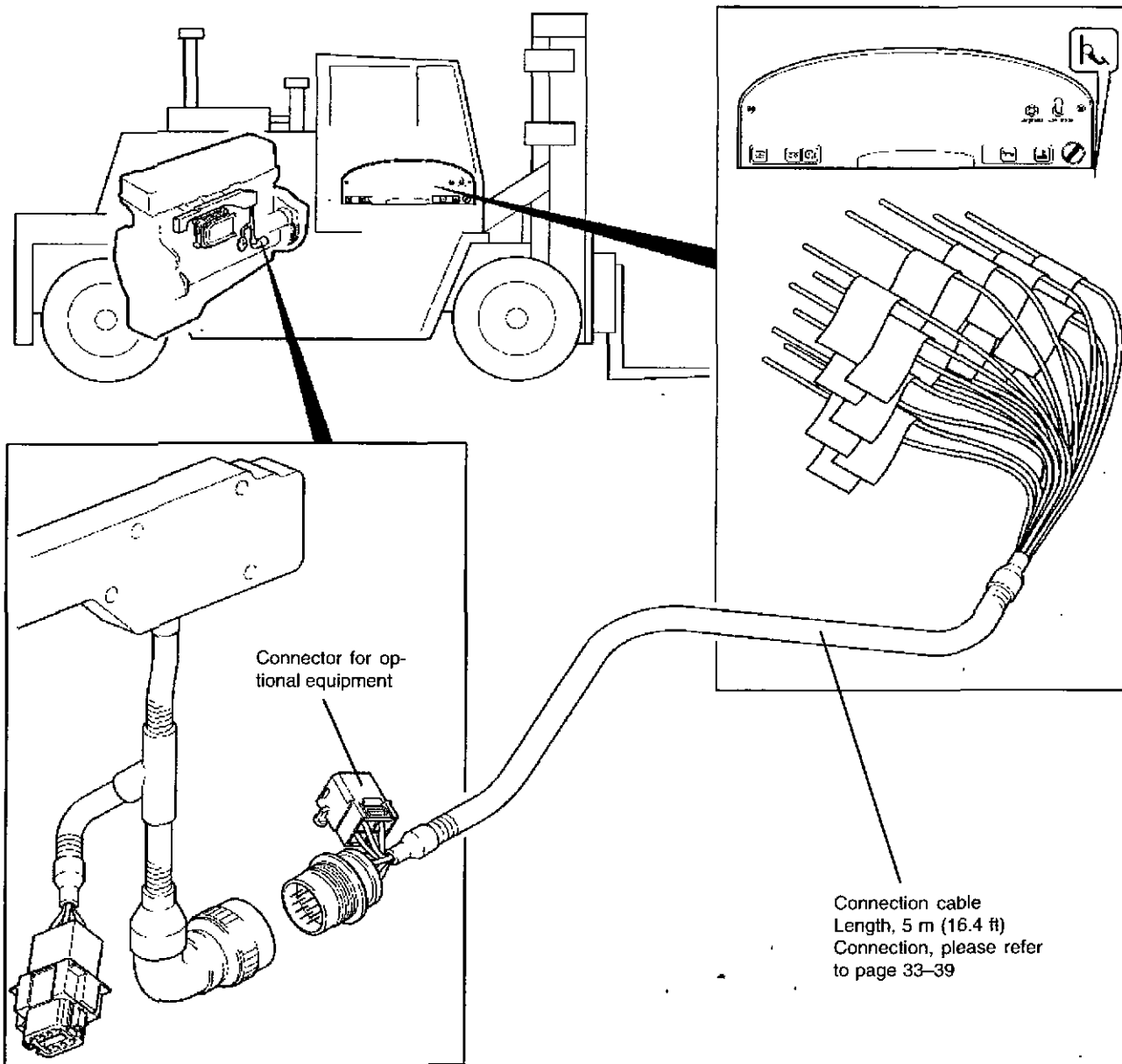

General information

The installation must be planned very thoroughly and done with the greatest care.

The connection cable between the engine and the instrument panel must be securely clamped. Remember that the connectors must also be supported so that they are not subjected to any tension.

Cables must not be run too close to hot components on the engine or close to any other source of heat. Make sure that it is protected from mechanical wear, sharp edges and water splashes. If necessary, run the cable through protective conduits.

Avoid making joints in the system as far as possible. Cables and any joints must be accessible for inspection and service

NOTE! The connectors must be installed "dry", they must not be packed with Vaseline etc.

Connector for optional equipment

The connection cable is provided with four extra conductors for connection of instrument sensors etc.

The four-pin connector is marked "Extra". The four cables are marked "T", "U", "V" and "W".

Connection

Engine management

(please refer to wiring diagram on page 39)

Starter switch

The starter switch is used to connect the system voltage, pre-heating function, starter function and stop function.

Position "0" = system voltage switched off

Position "I" = system voltage switched on

Position "II" = pre-heating on (spring biased)

Position "III" = starter motor engaged (spring biased)

Position "S" = stop function on (spring biased)

NOTE! The starting current for engine system voltage (control unit) is 10 A. Make sure that other components in the installation are dimensioned for this current density.

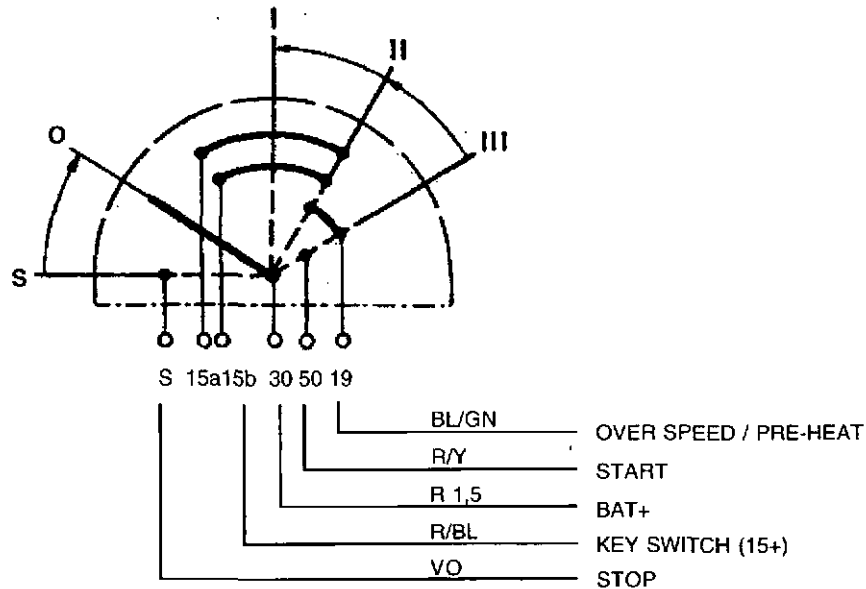
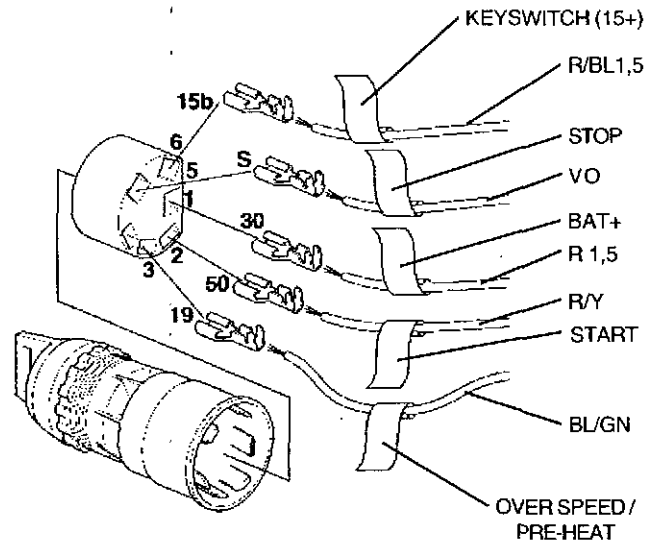

Droop contact

Contact type, two-position (NO).

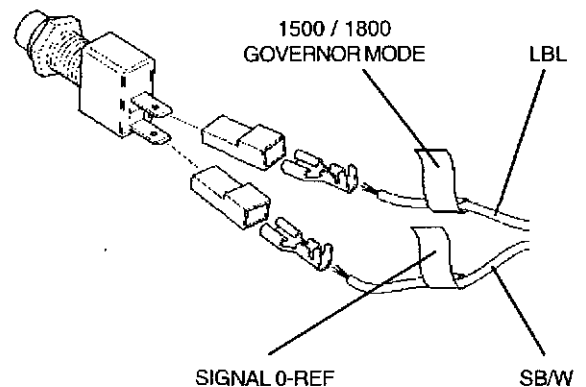

Accelerator pedal

Idling: 0.3 -1.9 V (Default value 1.60 V)

Full throttle: 1.9 -4.7 V (Default value 3.75 V)

If an accelerator pedal with different resistance and voltage values is used, the control unit must be re-calibrated with the parameter tool, please refer to "Parameter setting".

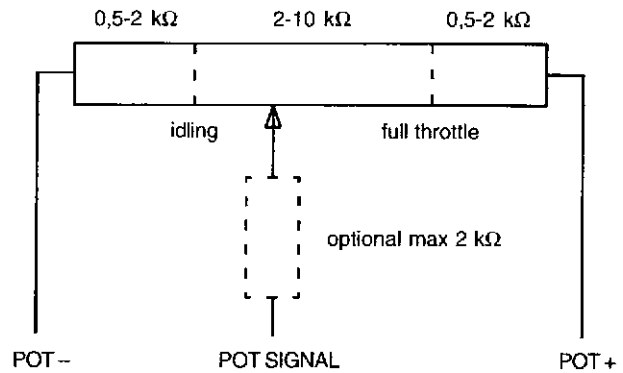

Idling switch

The accelerator has a built-in idling switch, which functions as a "Take you home device" if the potentiometer in the accelerator pedal should fail.

When the pedal is depressed, the contact is closed, and the engine speeds up in intervals to 80% of maximum speed. When the pedal is released, the contact opens and the engine falls back to idling speed.

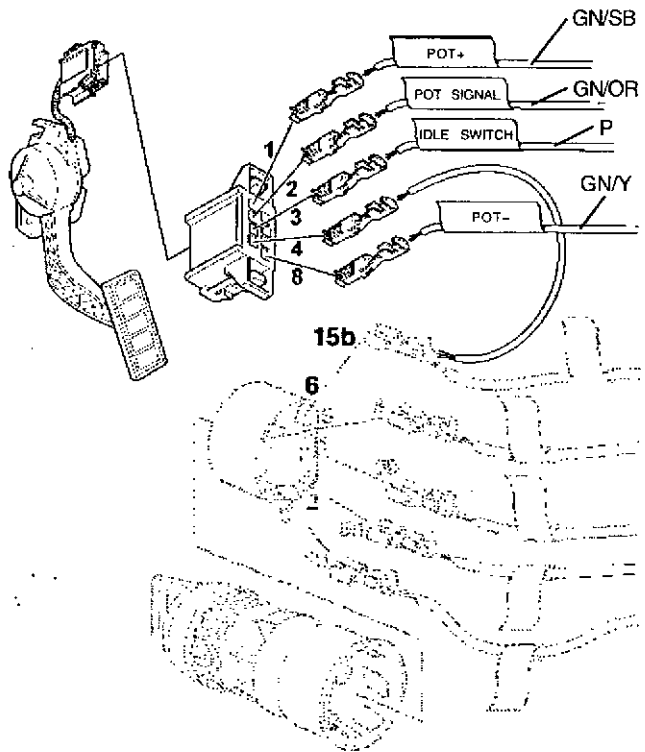

Warning and indication lamps

(please refer to wiring diagram on page 39)

Alarm, low oil pressure

Max. power 3 W
Voltage 24 V

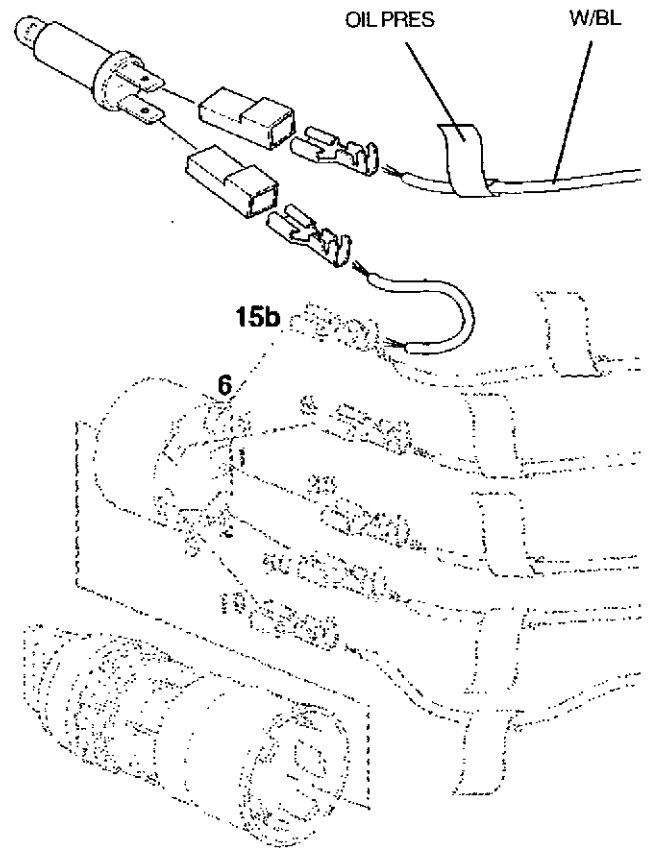

Alarm, high coolant temperature

Max. power 3 W
Voltage 24 V

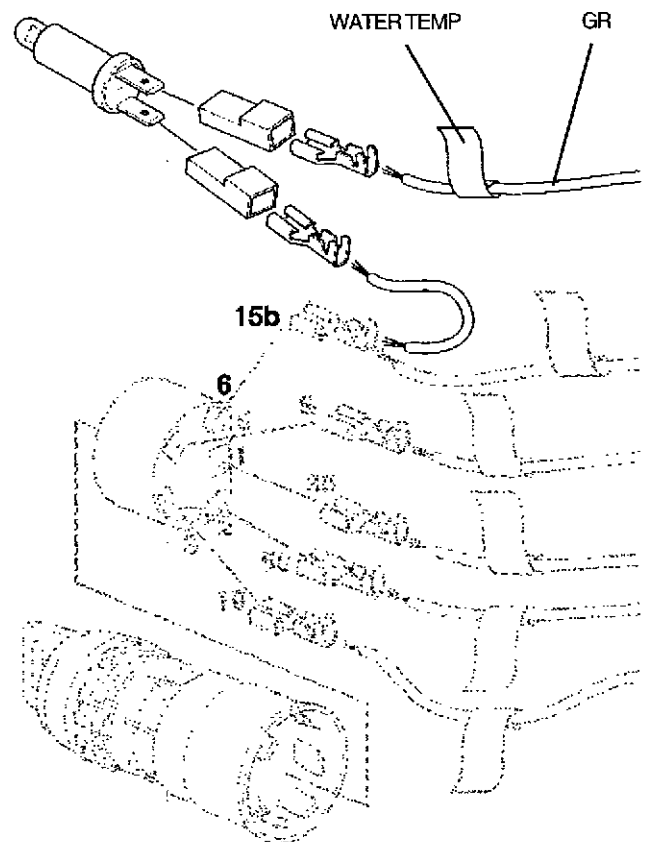

Alarm, low coolant level

Max. power 3 W
Voltage 24 V

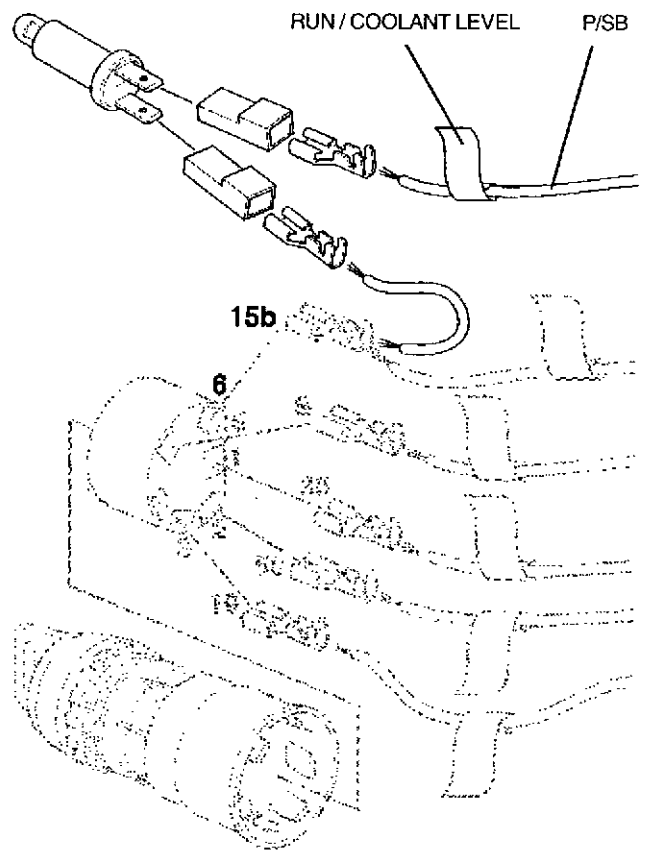

Diagnostic lamp

Max. power 3 W
Voltage 24 V

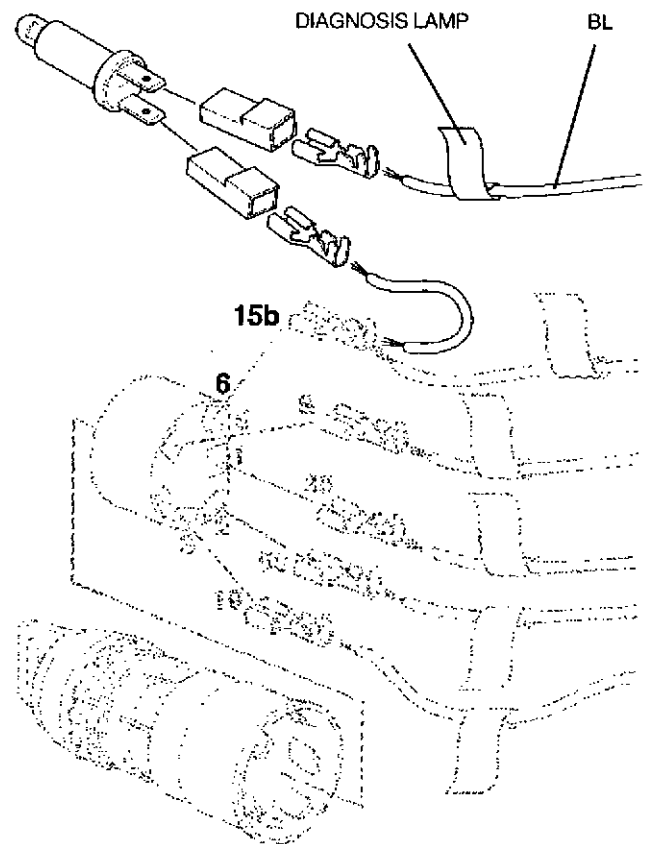

Pre-heating indication

Max. power 3 W

Voltage 24 V

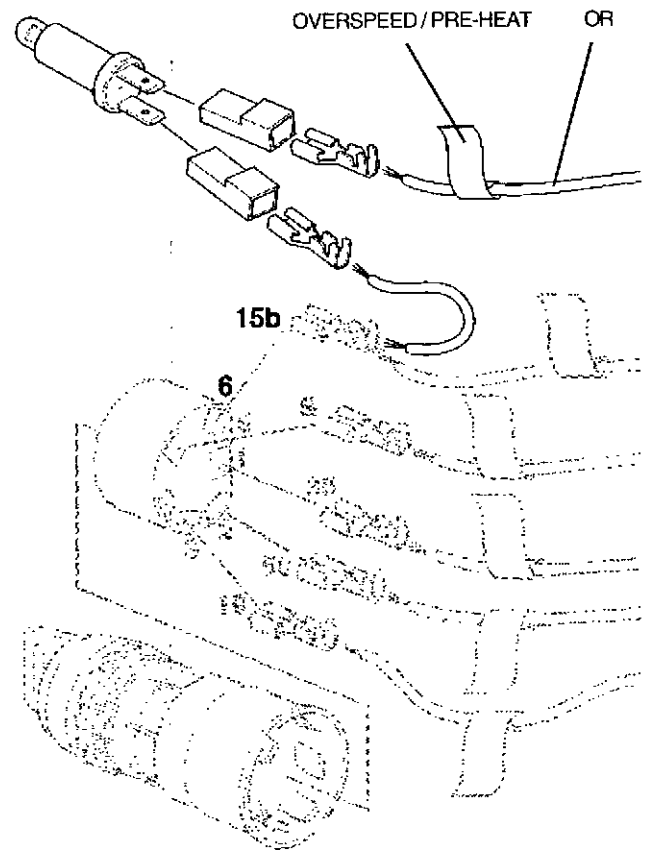

Other

(please refer to wiring diagram on page 39)

Diagnostic button

Contact type, closing (NO), spring biased.

To read the fault codes, please refer to chapter "Fault tracing".

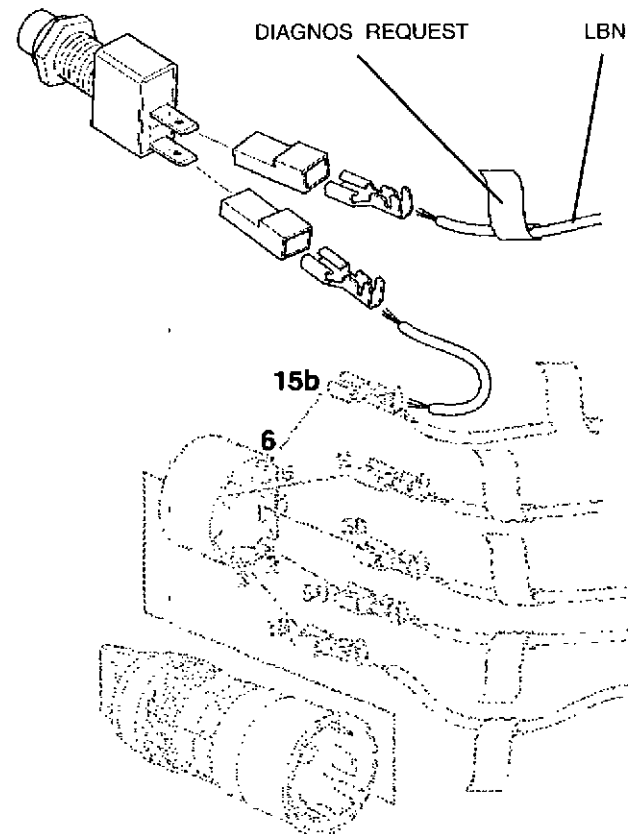

System reset

A system reset is used to delete fault codes which occurred during installation. For example, an incorrectly connected warning lamp will generate a fault code if it is removed when system voltage is switched on. This fault code is erased if a system reset is done and the lamp will be identified with its correct function.

A system reset restores, identifies and stores the current system configuration.

NOTE! Always finish off an engine installation by doing a system re-set.

Procedure

1. Press the "Diagnostic button" and keep it depressed when system voltage is switched on. Keep it depressed for 2-3 seconds after system voltage has been switched on.

The engine is now in "system reset mode".

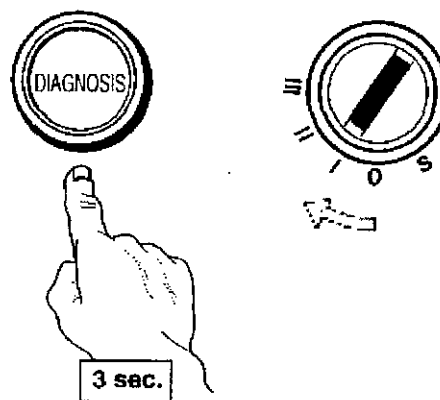

2. The system reset is completed by switching system voltage off.

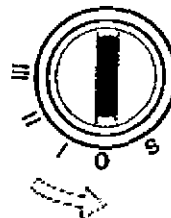

Wiring diagram

TWD1240VE (24 V system voltage, 2-pole)

1. Accelerator pedal
2. Droop contact
3. Start switch
4. Idling terminal
5. Pre-heating switch
6. Stop switch
7. Diagnosis
8. Alarm, low oil pressure
9. Alarm, high coolant temperature
10. Alarm, low coolant level
11. Pre-heating indication
12. Voltage after key
13. Battery negative
14. System on (key)
15. Battery positive
16. J1587 (bus)
17. J1939 CAN (bus)
18. Battery negative
19. Battery positive
20. Voltage after key
21. Connector
22. Programming connector
23. Diode
24. Stop button
25. Monitor, water in fuel
26. Relay socket
27. Main relay
28. Programming plug
29. Monitor, fuel pressure
30. Monitor, coolant level
31. Connector (2) (red)
32. Connector (1) (black)
33. Control unit EDC III
34. Unit injector (Cyl. 1-6)
35. Coolant temperature sensor
36. Charge air temperature/pressure sensor
37. Pre-heating
38. Relay, pre-heating
39. Sensor, camshaft (rpm)
40. Sensor, flywheel (rpm)
41. Alternator
42. Starter motor
43. Oil temperature/pressure sensor
44. Battery (24 V)
45. Stand Alone Connector
46. Data bus connector

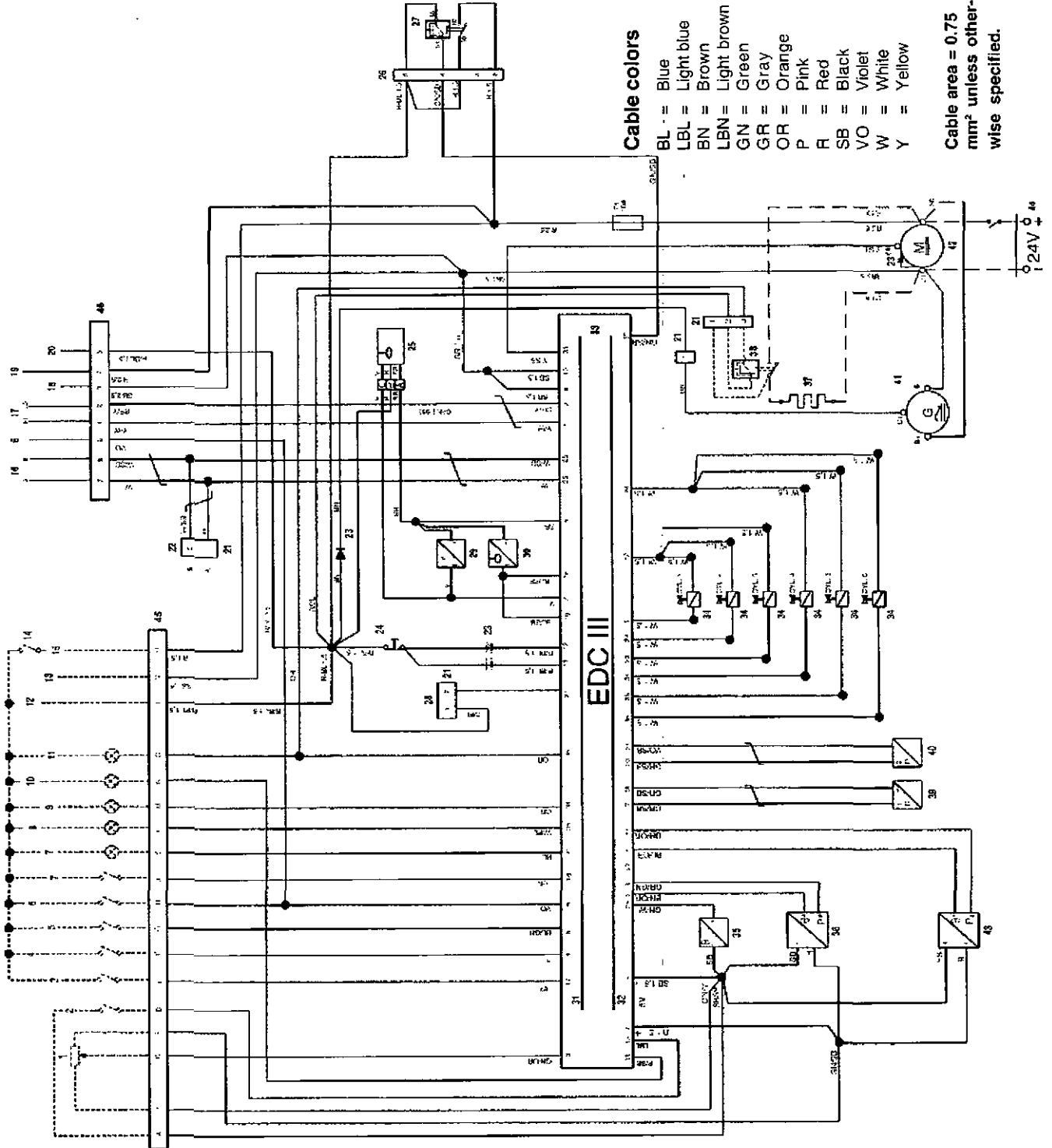

Cable colors

- BL = Blue
- LBL = Light blue
- BN = Brown
- LBN = Light brown
- GN = Green
- OR = Orange
- P = Pink
- R = Red
- SB = Black
- VO = Violet
- W = White
- Y = Yellow

Cable area = 0.75 mm² unless otherwise specified.

Parameter setting

Connection, parameter tool

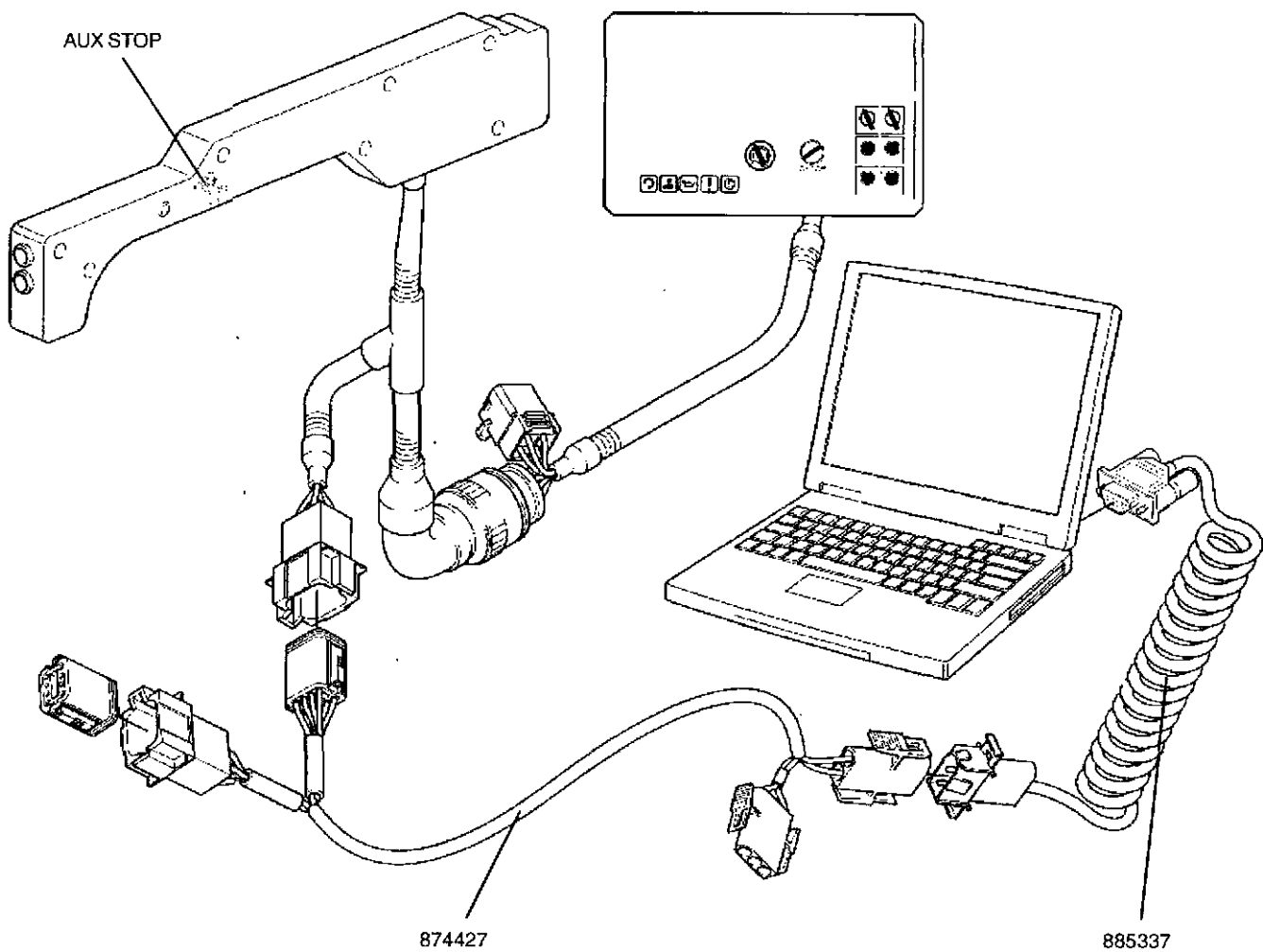

Operation

Connect your laptop as above. Use T-piece, part no. 874427 and communication cable part no. 885337.

Install the "Parameter setting tool" software.

Switch the ignition (do **not** start the engine)

Start the parameter setting tool and follow the instructions in the accompanying manual.

The tool shows the parameters which can be connected on that engine, also see the next page.

NOTE! Finish programming by switching off the ignition with the "AUX STOP" button.

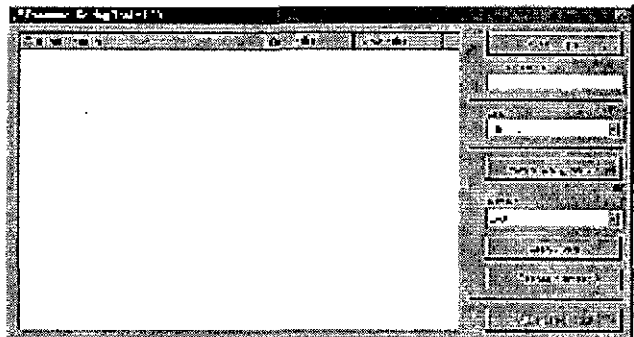

Adjustable parameters TWD1240VE (Standalone)

NOTE! Some parameters require special authorization.

Alarm limit for oil temperature

The warning lamp is lit at this temperature.

Min. value	120 °C (248 °F)
Default value	125 °C (257 °F)
Max. value	130 °C (266 °F)

Lamp test

This parameter selects whether a lamp test should be done when the system starts up.

Alternative positions "Off" or "On"
Default value "On"

Idling voltage EMS

Voltage on the throttle control input on the EMS unit, corresponding to idling.

Min. value	0.3 V
Default value	1.6 V
Max. value	1.9 V

Max. speed voltage, EMS

Voltage on the throttle control input on the EMS unit, corresponding to full throttle.

Min. value	1.9 V
Default value	3.75 V
Max. value	4.7 V

Alarm limit for coolant temperature

The warning lamp is lit at this temperature.

Min. value	95 °C (203 °F)
Default value	98 °C (208 °F)
Max. value	101 °C (214 °F)

Idling speed.

Setting idling speed

Min. value	600 rpm
Default value	600 rpm
Max. value	1200 rpm

Stop EMS: connected to system voltage at

Stop input on EMS unit connected to system voltage at "Run" or "Stop".

Default value "Stop"

Control gradient

Selects the amount of droop to be used (gradient).

Min. value	10 Nm/rpm (7.38 lbf ft/rpm)
Default value	25 Nm/rpm (18.44 lbf ft/rpm)
Max. value	127 Nm/rpm (93.67 lbf ft/rpm)

Engine protection charge air temperature

Chooses whether engine protection should be activated in relation to high charge air temperature.

Alternative positions "Off" or "On"
Default value "On"

Engine protection coolant level

Chooses whether engine protection should be activated in relation to low coolant level.

Alternative positions "Off" or "On"
Default value "On"

Engine protection coolant temperature

Chooses whether engine protection should be activated in relation to high coolant temperature.

Alternative positions "Off" or "On"
Default value "On"

Engine protection oil pressure

Chooses whether engine protection should be activated in relation to low oil pressure.

Alternative positions "Off" or "On"

Default value "On"

Engine protection oil temperature

Chooses whether engine protection should be activated in relation to high oil temperature.

Alternative positions "Off" or "On"

Default value "On"

Primary control position

Selects the engine speed to be used when the no regulator controller is used.

Alternative positions "Isochronous" or "Droop"

Default value "Isochronous"

Pre-heating on switch-on

Parameter which selects whether automatic pre-heating should be used.

Alternative positions "Off" or "On"

Default value "Off"

Maximum engine speed

Setting of maximum engine speed

Min. value 1500 rpm

Default value 2100 rpm

Max. value 2200 rpm

 **IMPORTANT!** No changes may be done to the basic setting values of the engine since this affects exhaust emissions, and thus affects certification requirements.

TWD1240VE (CIU)

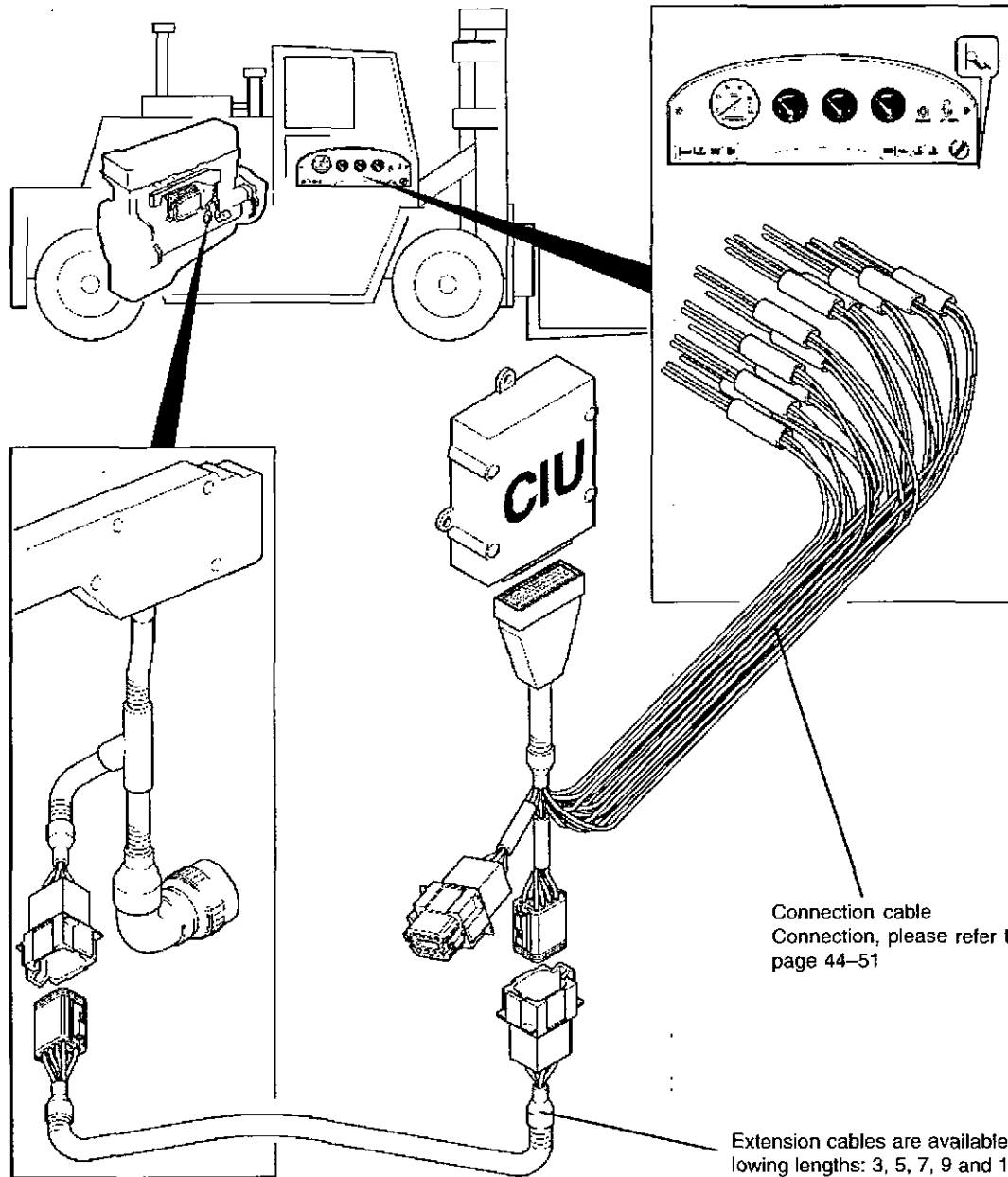

Connection cable
Connection, please refer to
page 44-51

Extension cables are available in the fol-
lowing lengths: 3, 5, 7, 9 and 11 m
(9.8, 16.4, 23, 29.5 and 36 ft)

General information

The installation must be planned very thoroughly and done with the greatest care.

The connection cable between the engine and the instrument panel must be securely clamped. Remember that the connectors must also be supported so that they are not subjected to any tension.

Cables must not be run too close to hot components on the engine or close to any other source of heat. Make sure that it is protected from mechanical wear, sharp edges and water splashes. If necessary, run the cable through protective conduits.

Avoid making joints in the system as far as possible. Cables and any joints must be accessible for inspection and service

NOTE! The connectors must be installed "dry", they must not be packed with Vaseline etc.

Accelerator pedal

Idling: 0.3 -1.9 V (Default value 1.17 V)

Full throttle: 1.9 -4.7 V (Default value 4.5 V)

If an accelerator pedal with different resistance and voltage values is used, the control unit must be re-calibrated with the parameter tool, please refer to "Parameter setting".

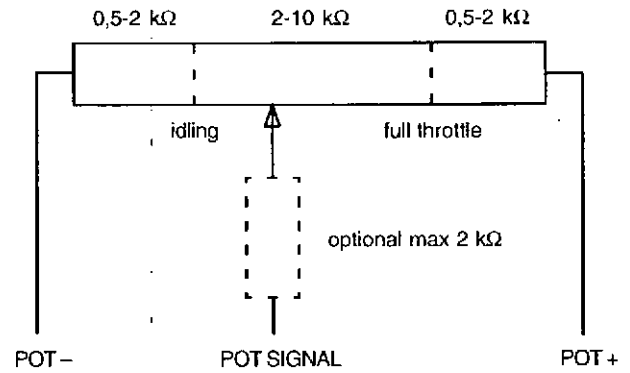

Idling switch

The accelerator has a built-in idling switch, which functions as a "Take you home device" if the potentiometer in the accelerator pedal should fail.

When the pedal is depressed, the contact is closed, and the engine speeds up in intervals to 80% of maximum speed. When the pedal is released, the contact opens and the engine falls back to idling speed.

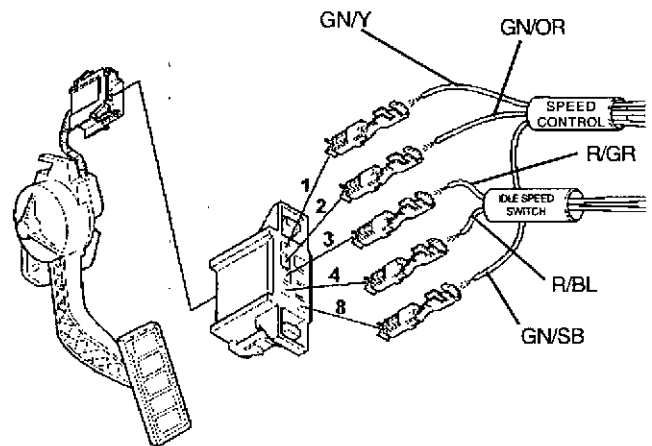

1500 / 1800 rpm switch

NOTE! This function is **not** connected on the TWD1240VE.

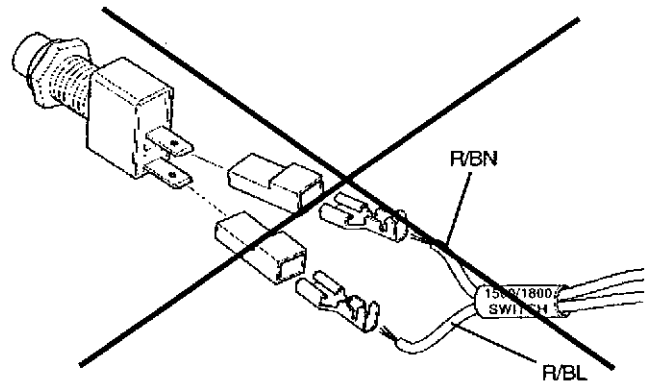

Warning and indication lamps

(please refer to wiring diagram on page 51)

Alarm, low oil pressure

Max. power 3 W
Voltage 24 V

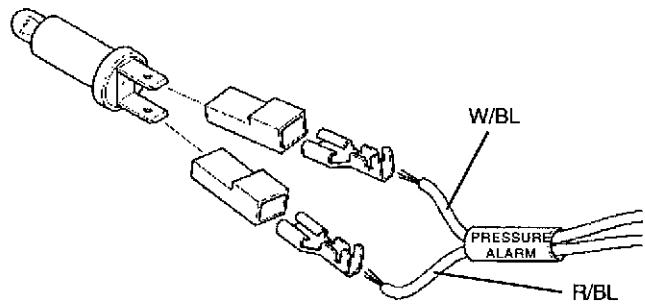

Alarm, high oil temperature

Max. power 3 W
Voltage 24 V

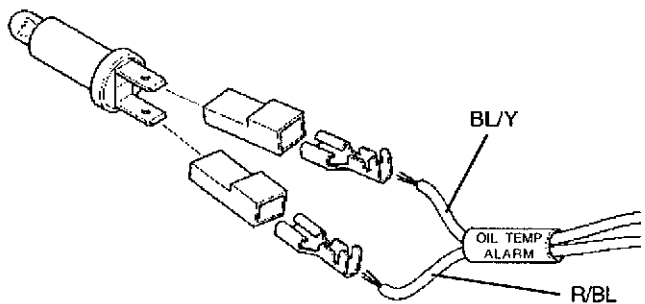

Alarm, high coolant temperature

Max. power 3 W
Voltage 24 V

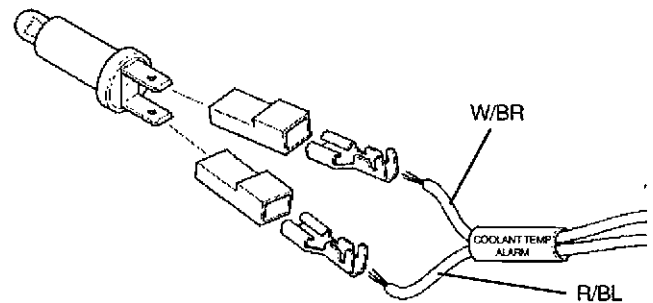

Alarm, low coolant level

Max. power 3 W
Voltage 24 V

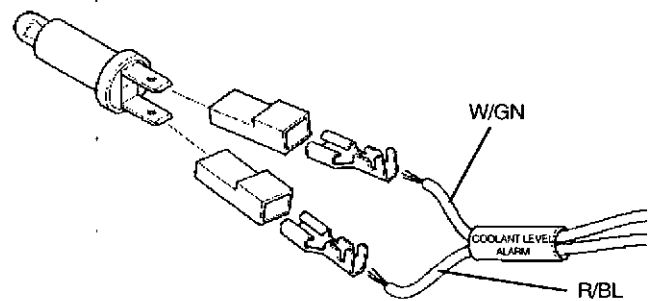

Fuel alarm

Max. power 3 W
Voltage 24 V

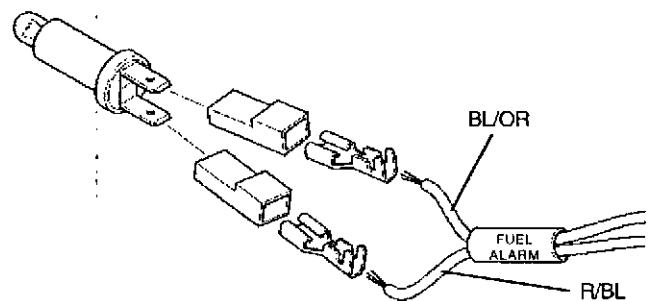

Charge indication

Max. power 3 W
Voltage 24 V

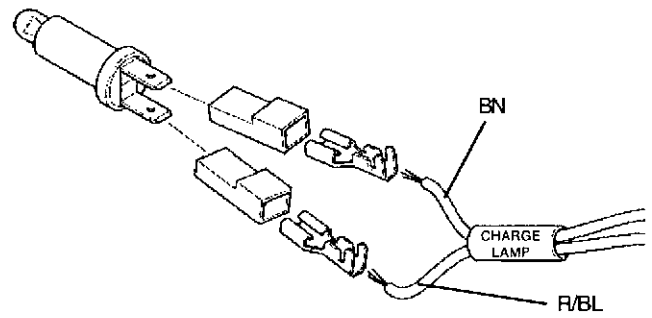

Diagnostic lamp

Max. power 3 W
Voltage 24 V

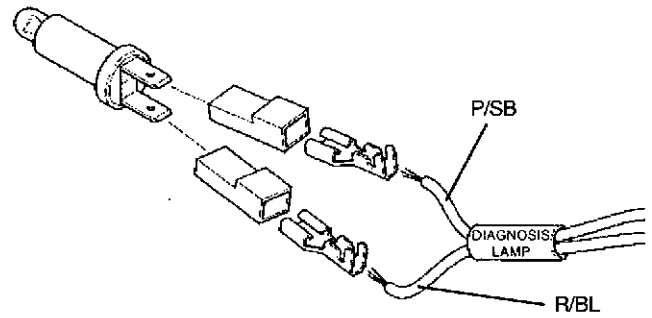

Pre-heating indication

Max. power 3 W
Voltage 24 V

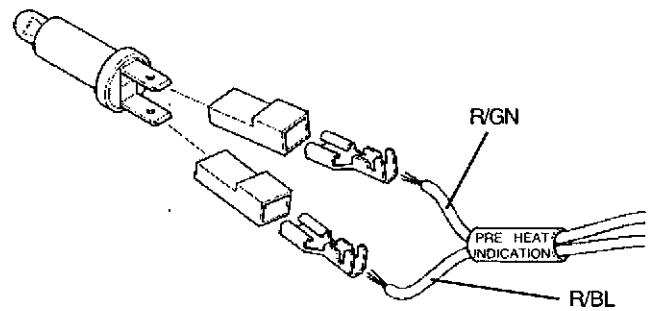

Overspeed indication

NOTE! This function is **not** connected on the TWD1240VE.

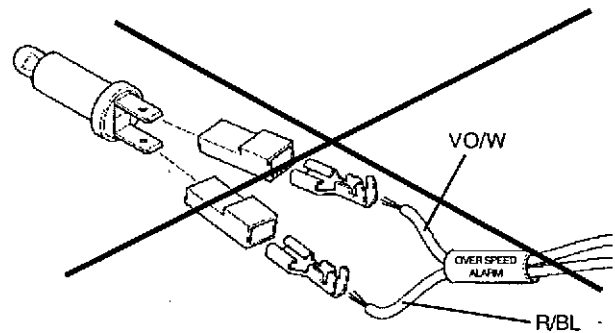

Operation indication

NOTE! This function is **not** connected on the TWD1240VE.

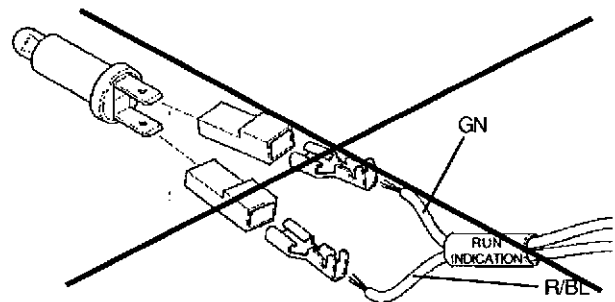

Instruments

(please refer to wiring diagram on page 51)

Tachometer

Use Volvo Penta's (VDO) universal tachometer, graduated 0-2600 rpm.

Set code 14, please refer to installation instruction 7739513-5.

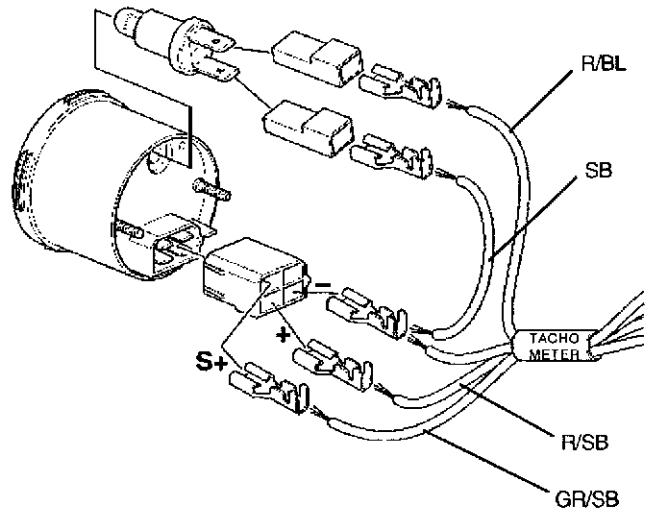

Oil pressure instrument

Use Volvo Penta's (VDO) oil pressure instrument, graduated 0-10 bar (0-145 PSI).

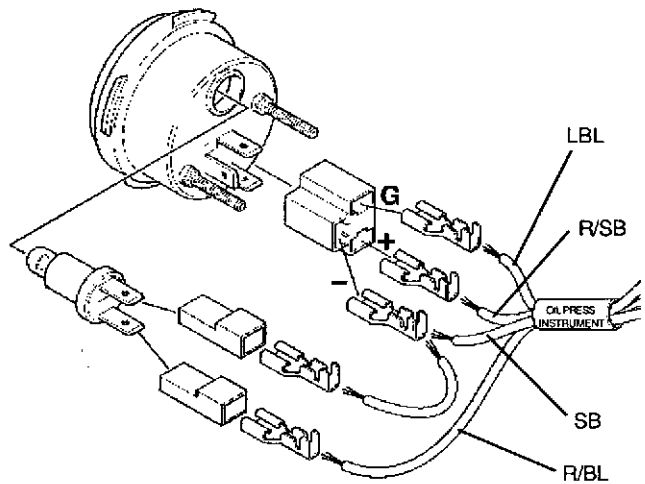

Oil temperature instrument

Use Volvo Penta's (VDO) oil temperature instrument, graduated 40-150 °C (140-302 °F).

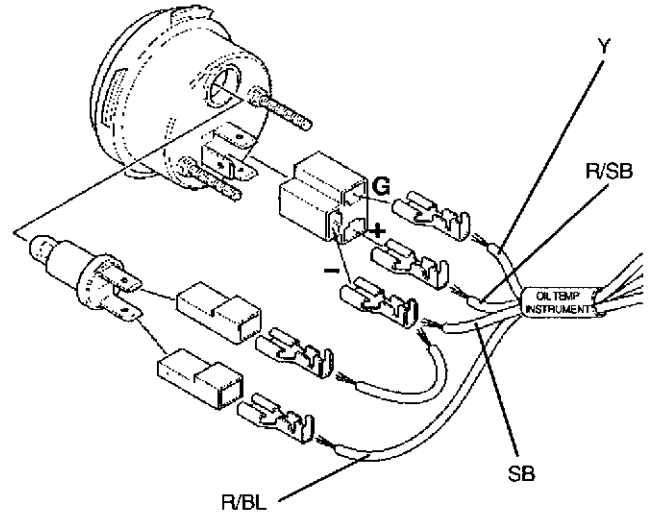

Coolant temperature instrument

Use Volvo Penta's (VDO) coolant temperature instrument, graduated 40-120°C (140-248 °F).

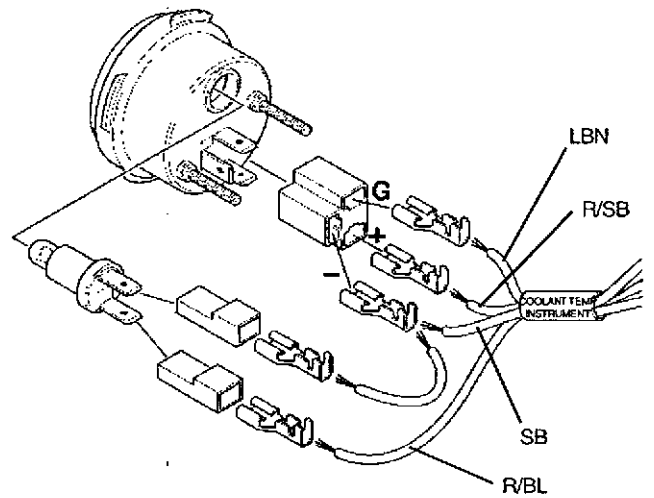

Other

(please refer to wiring diagram on page 51)

Diagnostic connector

Contact type, closing (NO), spring biased.

To read the fault codes, please refer to chapter "Fault tracing".

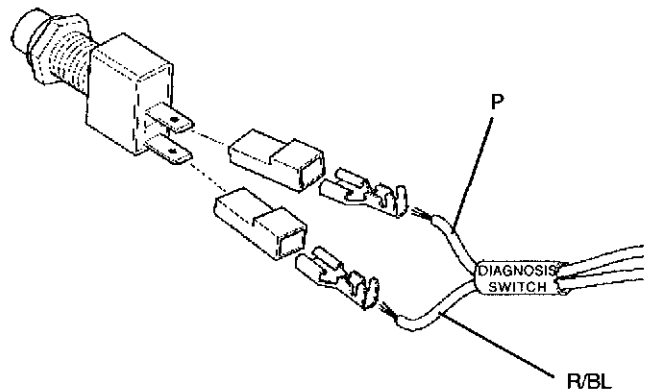

System reset

A system reset is used to delete fault codes which occurred during installation. For example, an incorrectly connected warning lamp will generate a fault code if it is removed when system voltage is switched on. This fault code is erased if a system reset is done and the lamp will be identified with its correct function.

A system reset restores, identifies and stores the current system configuration.

NOTE! Always finish off an engine installation by doing a system re-set.

Procedure

1. Press the "Diagnostic button" and keep it depressed when system voltage is switched on. Keep it depressed for 2-3 seconds after system voltage has been switched on.

The engine is now in "system reset mode".

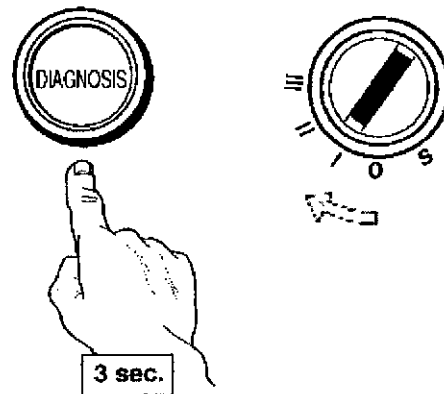

2. The system reset is completed by switching system voltage off.

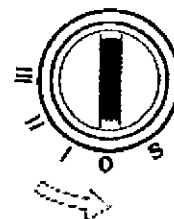

Wiring diagram

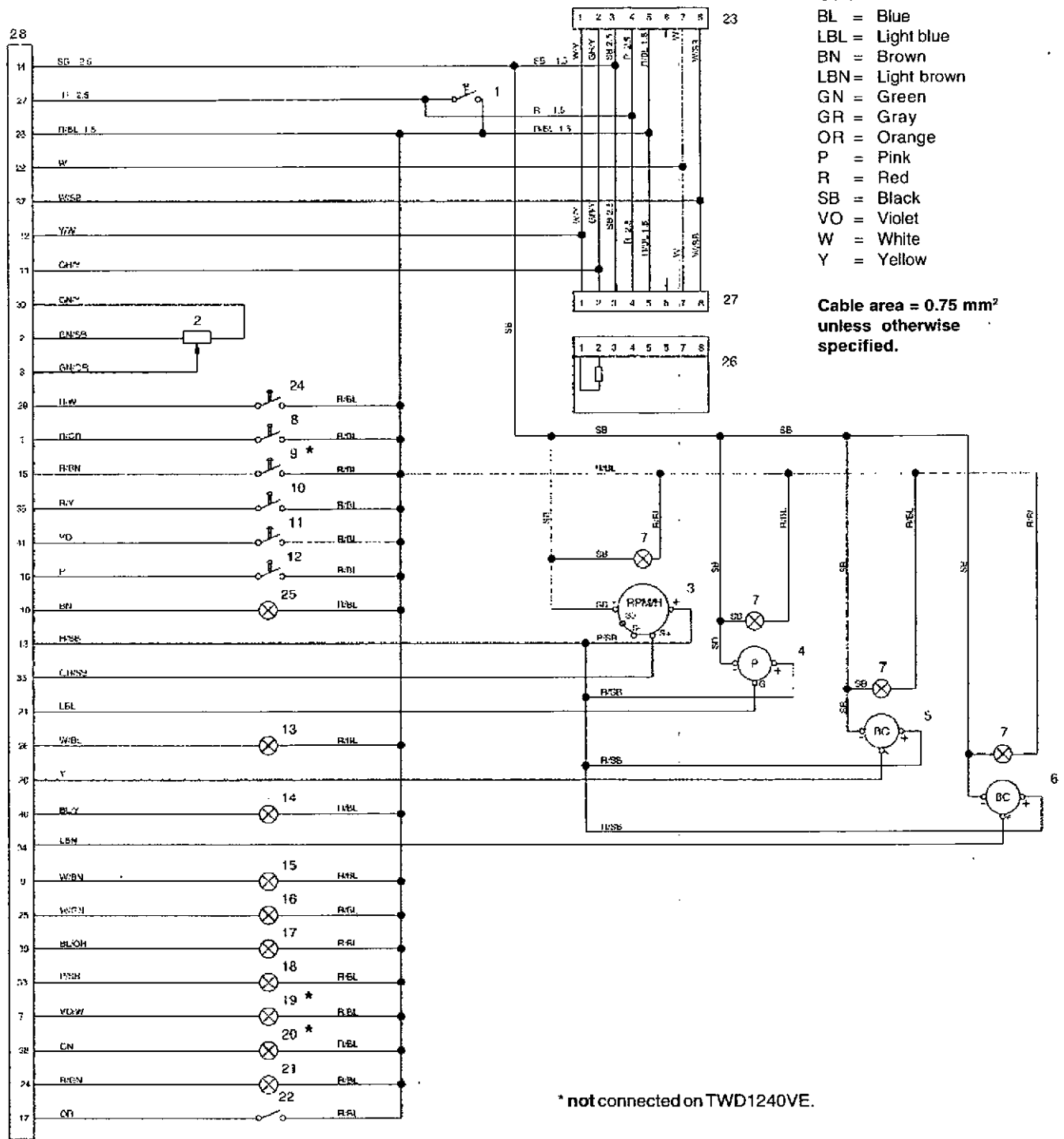

Wiring diagram, control interface unit (CIU)

- | | | | |
|-----|---|-----|---|
| 1. | Key switch, driving current (15+) | 16. | Alarm, low coolant level |
| 2. | Engine speed potentiometer | 17. | Fuel alarm |
| 3. | Tachometer (code 14) | 18. | Diagnostic lamp |
| 4. | Oil pressure, instrument | 19. | Overspeed indication (not connected on TWD1240VE). |
| 5. | Oil temperature, instrument | 20. | Operation indication (not connected on TWD1240VE). |
| 6. | Coolant temperature, instrument | 21. | Pre-heating indication |
| 7. | Instrument lighting | 22. | Pre-heating contact, spring biased |
| 8. | Idling contact, two-way | 23. | 8-pin Deutsch connector, pin |
| 9. | 1500/1800 contact (not connected on TWD1240VE) | 24. | Regulator connector, two-position |
| 10. | Starter contact, spring biased | 25. | Charge indication |
| 11. | Stop switch, spring biased | 26. | Termination resistor 120 Ohm |
| 12. | Diagnostic contact, spring biased | 27. | 8-pin Deutsch connector, socket |
| 13. | Alarm, low oil pressure | 28. | Control Interface Unit (CIU) |
| 14. | Alarm, high oil temperature | | |
| 15. | Alarm, high coolant temperature | | |

Parameter setting

Connection, parameter tool

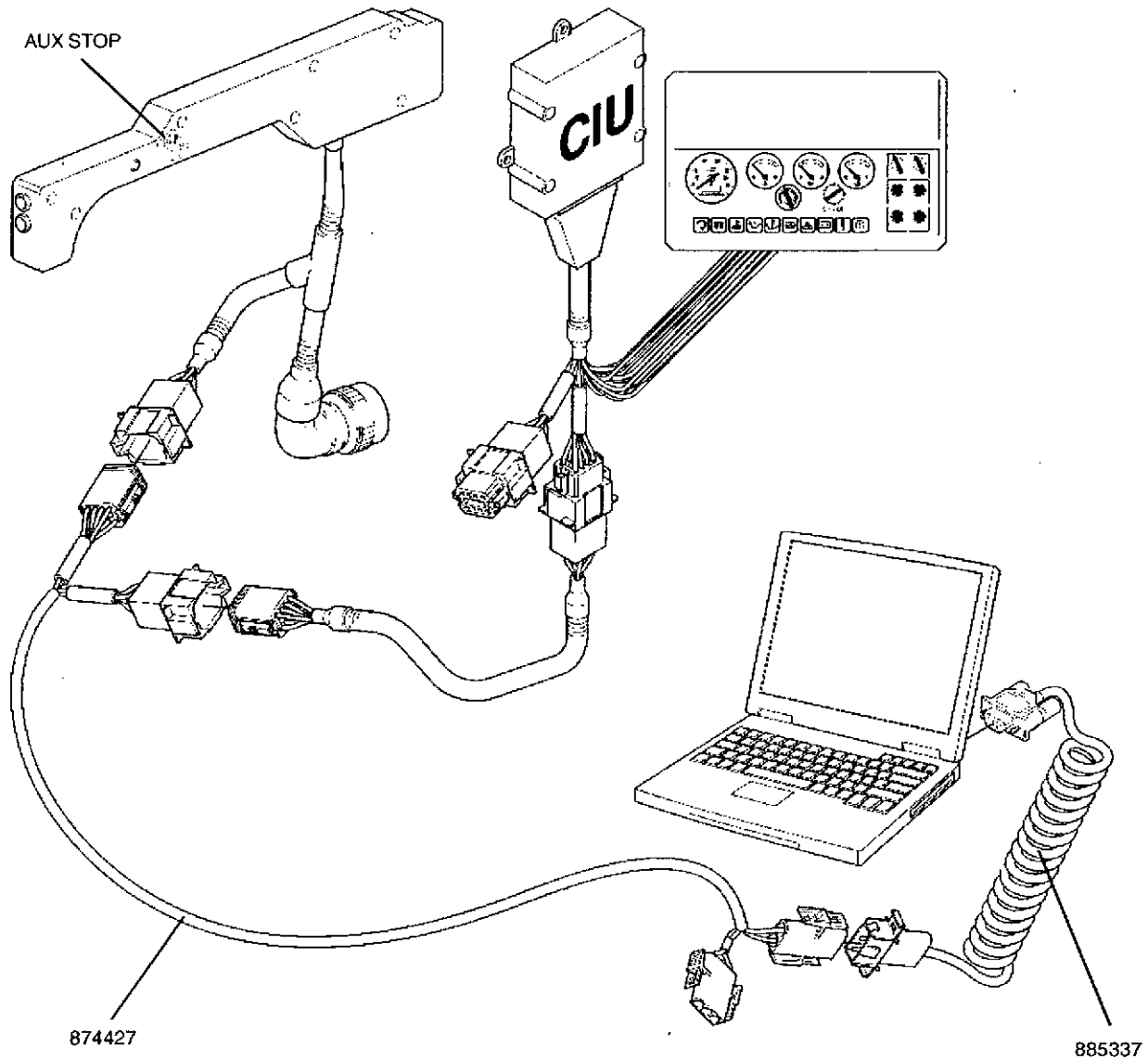

Operation

Connect your laptop as above. Use T-piece, part no. 874427 and communication cable part no. 885337.

Install the "Parameter setting tool" software.

Switch the ignition (do **not** start the engine)

Start the parameter setting tool and follow the instructions in the accompanying manual.

The tool shows the parameters which can be connected on that engine, also see the next page.

NOTE! Finish programming by switching off the ignition with the "AUX STOP" button.

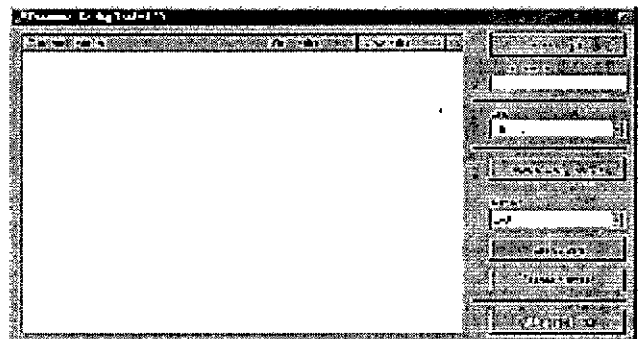

Adjustable parameters TWD1240VE (CIU)

NOTE! Some parameters require special authorization.

Stop CIU: Connected to system voltage at

Stop input on CIU unit connected to system voltage at "Run" or "Stop".

Default value "Stop"

Idling voltage CIU

Voltage on the throttle control input on the CIU unit, corresponding to idling.

Min. value 0.3 V
Default value 1.17 V
Max. value 1.9 V

Max. speed voltage, CIU

Voltage on the throttle control input on the CIU unit, corresponding to full throttle.

Min. value 1.9 V
Default value 4.5 V
Max. value 4.7 V

Alarm limit for oil temperature

The warning lamp is lit at this temperature.

Min. value 120 °C (248 °F)
Default value 125 °C (257 °F)
Max. value 130 °C (266 °F)

Lamp test

This parameter selects whether a lamp test should be done when the system starts up.

Alternative positions "Off" or "On"
Default value "On"

Alarm limit for coolant temperature

The warning lamp is lit at this temperature.

Min. value 95 °C (203 °F)
Default value 98 °C (208 °F)
Max. value 101 °C (214 °F)

Idling speed.

Setting idling speed

Min. value 600 rpm
Default value 600 rpm
Max. value 1200 rpm

Control gradient

Selects the amount of droop to be used (gradient).

Min. value 10 Nm/rpm (7.38 lbf ft/rpm)
Default value 25 Nm/rpm (18.44 lbf ft/rpm)
Max. value 127 Nm/rpm (93.67 lbf ft/rpm)

Engine protection charge air temperature

Chooses whether engine protection should be activated in relation to high charge air temperature.

Alternative positions "Off" or "On"
Default value "On"

Engine protection coolant level

Chooses whether engine protection should be activated in relation to low coolant level.

Alternative positions "Off" or "On"
Default value "On"

Engine protection coolant temperature

Chooses whether engine protection should be activated in relation to high coolant temperature.

Alternative positions "Off" or "On"
Default value "On"

Engine protection oil pressure

Chooses whether engine protection should be activated in relation to low oil pressure.

Alternative positions "Off" or "On"

Default value "On"

Engine protection oil temperature

Chooses whether engine protection should be activated in relation to high oil temperature.

Alternative positions "Off" or "On"

Default value "On"

Primary control position

Selects the engine speed to be used when the no regulator controller is used.

Alternative positions "Isochronous" or "Droop"

Default value "Isochronous"

Pre-heating on switch-on

Parameter which selects whether automatic pre-heating should be used.

Alternative positions "Off" or "On"

Default value "Off"

Maximum engine speed

Setting of maximum engine speed

Min. value 1500 rpm

Default value 2100 rpm

Max. value 2200 rpm



IMPORTANT! No changes may be done to the basic setting values of the engine since this affects exhaust emissions, and thus affects certification requirements.

TWD1240VE (Power Pack)

General information

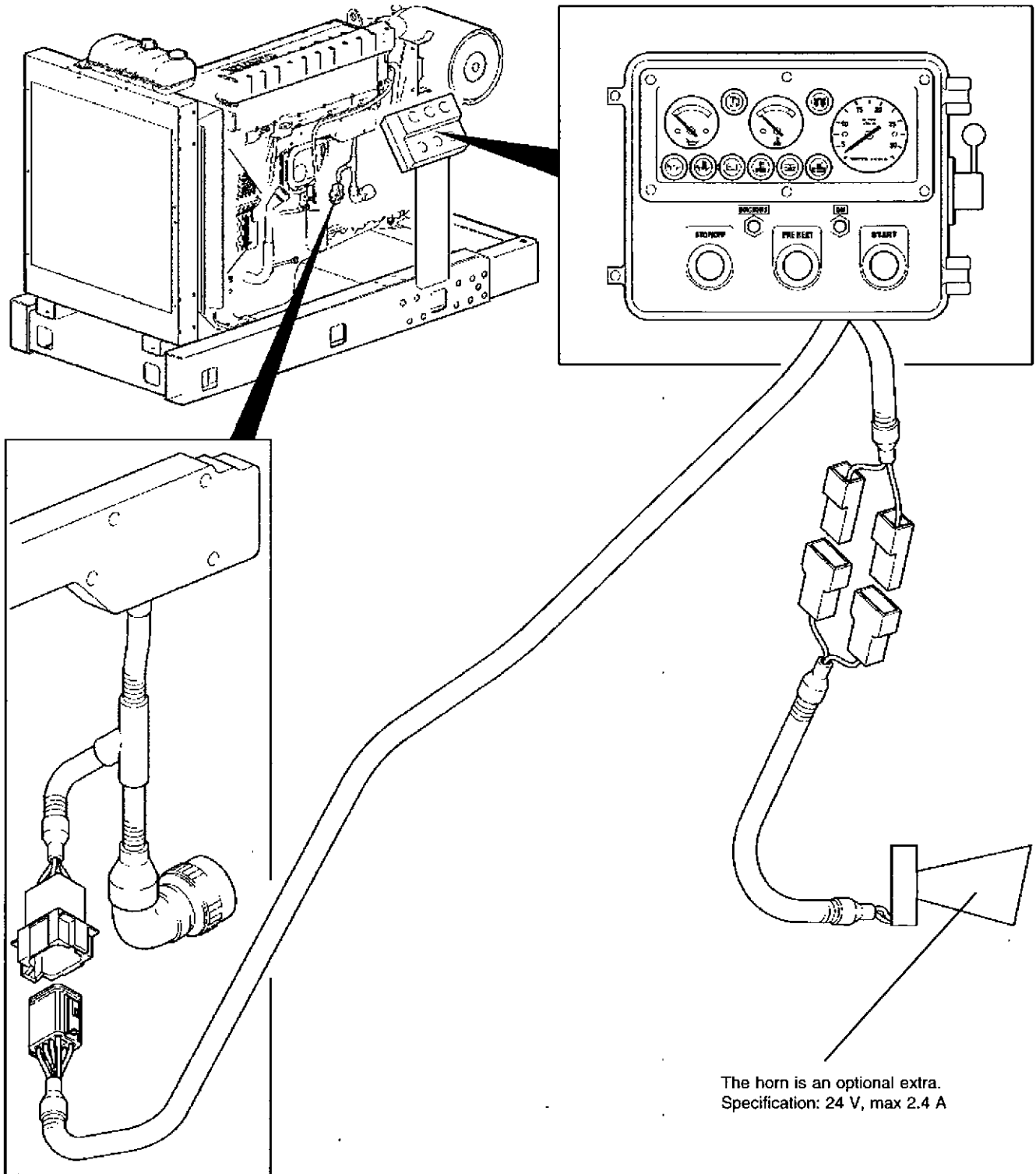

The horn is an optional extra.
Specification: 24 V, max 2.4 A

Wiring diagram

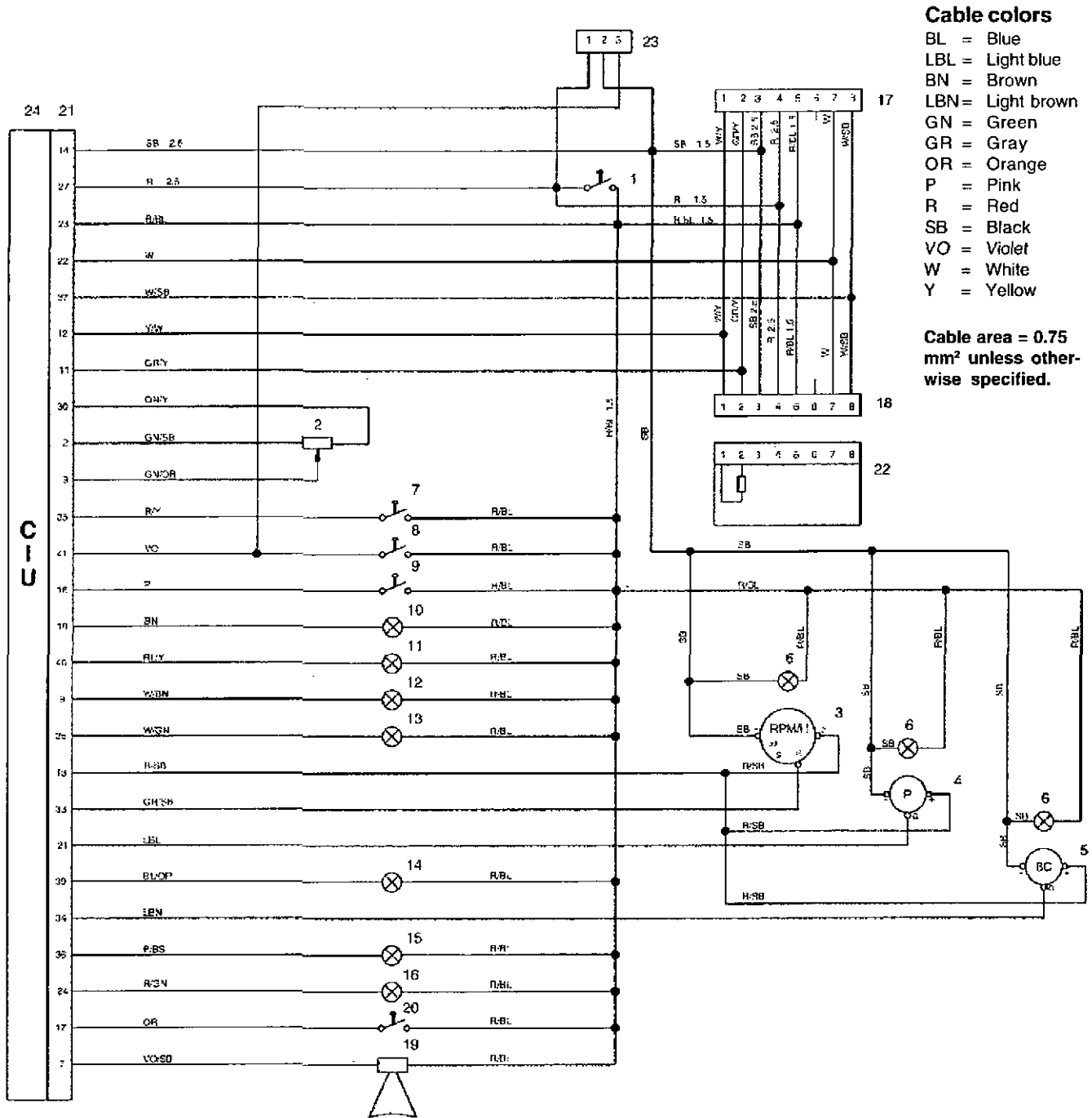

- | | |
|--|--|
| <ol style="list-style-type: none"> 1. Activation, driving current contact (15+) 2. Engine speed potentiometer 3. Tachometer code 14 4. Oil pressure, instrument 5. Coolant temperature, instrument 6. Instrument lighting 7. Starter contact, spring biased 8. Stop switch, spring biased 9. Diagnostic contact, spring biased 10. Charge indication 11. Alarm, high oil temperature 12. Alarm, high coolant temperature | <ol style="list-style-type: none"> 13. Alarm, low coolant level 14. Fuel alarm 15. Diagnostic lamp 16. Pre-heating indication 17. 8-pin Deutsch connector, pin 18. 8-pin Deutsch connector, pin 19. Horn, audible warning alarm 20. Pre-heating button, spring biased (optional) 21. 42-pin connector 22. Termination resistor 120 Ohm 23. Extra connector for 24 V and stop. 24. Control Interface Unit (CIU) |
|--|--|

Parameter setting

Connection, parameter tool

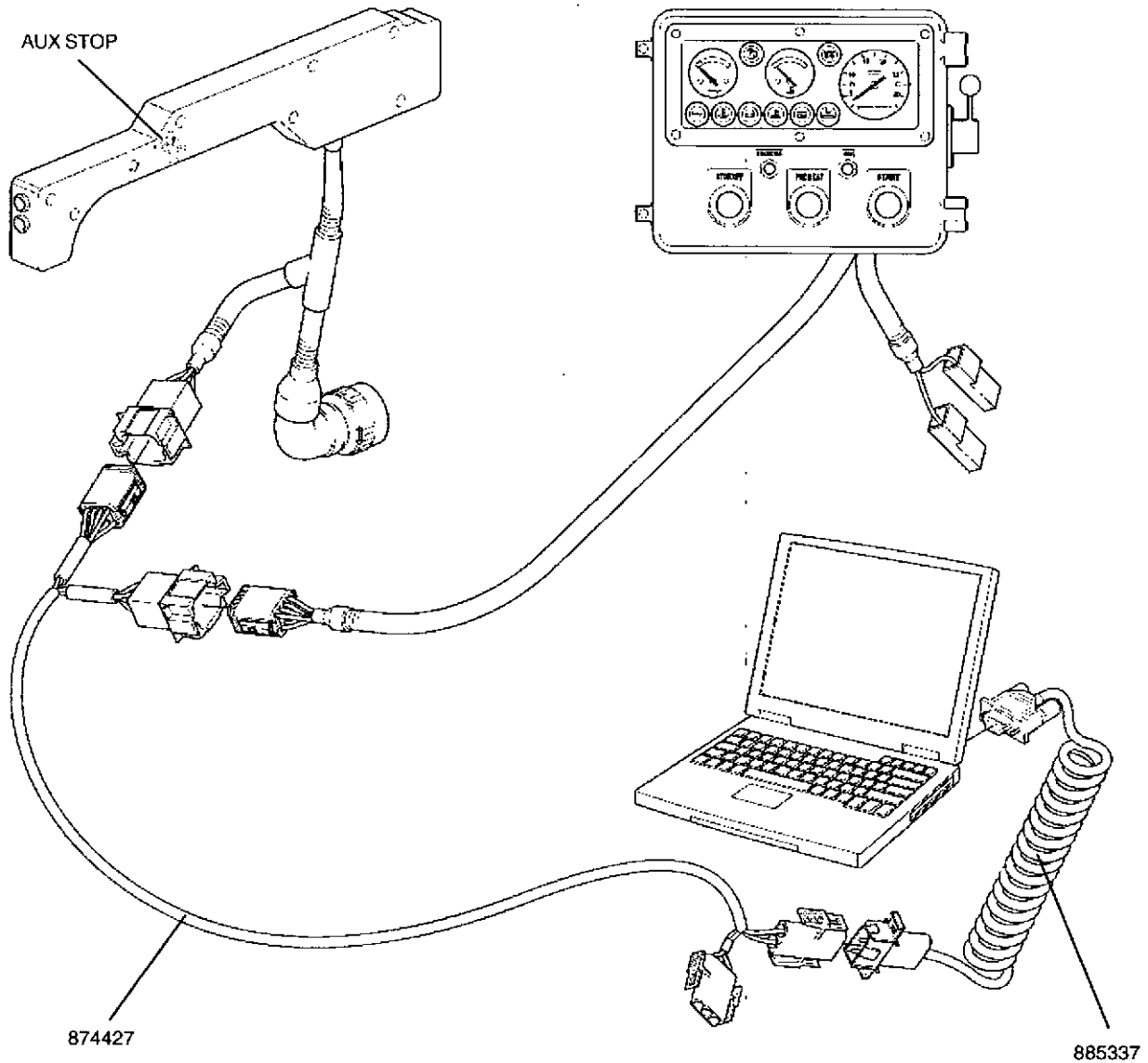

Operation

Connect your laptop as above. Use T-piece, part no. 874427 and communication cable part no. 885337.

Install the "Parameter setting tool" software.

Switch the ignition (do **not** start the engine)

Start the parameter setting tool and follow the instructions in the accompanying manual.

The tool shows the parameters which can be connect-ed on that engine, also see the next page.

NOTE! Finish programming by switching off the igni-tion with the "AUX STOP" button.

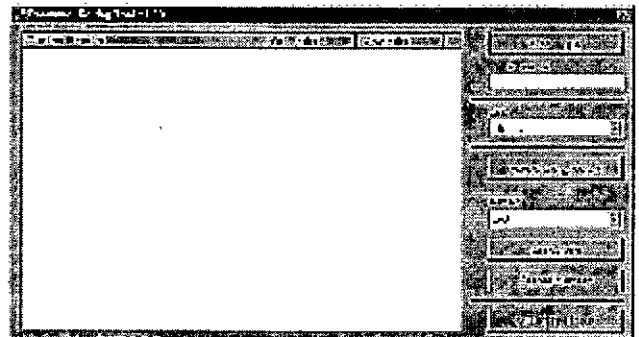

Adjustable parameters

TWD1240VE Power Pack

NOTE! Some parameters require special authorization.

Stop CIU: Connected to system voltage at

Stop input on CIU unit connected to system voltage at "Run" or "Stop".

Default value "Stop"

Idling voltage CIU

Voltage on the throttle control input on the CIU unit, corresponding to idling.

Min. value	0.3 V
Default value	1.17 V
Max. value	1.9 V

Max. speed voltage, CIU

Voltage on the throttle control input on the CIU unit, corresponding to full throttle.

Min. value	1.9 V
Default value	4.5 V
Max. value	4.7 V

Alarm limit for oil temperature

The warning lamp is lit at this temperature.

Min. value	120 °C (248 °F)
Default value	125 °C (257 °F)
Max. value	130 °C (266 °F)

Lamp test

This parameter selects whether a lamp test should be done when the system starts up.

Alternative positions "Off" or "On"
Default value "On"

Alarm limit for coolant temperature

The warning lamp is lit at this temperature.

Min. value	95 °C (203 °F)
Default value	98 °C (208 °F)
Max. value	101 °C (214 °F)

Idling speed.

Setting idling speed

Min. value	600 rpm
Default value	600 rpm
Max. value	1200 rpm

Control gradient

Selects the amount of droop to be used (gradient).

Min. value	10 Nm/rpm (7.38 lbf ft/rpm)
Default value	25 Nm/rpm (18.44 lbf ft/rpm)
Max. value	127 Nm/rpm (93.67 lbf ft/rpm)

Engine protection charge air temperature

Chooses whether engine protection should be activated in relation to high charge air temperature.

Alternative positions "Off" or "On"
Default value "On"

Engine protection coolant level

Chooses whether engine protection should be activated in relation to low coolant level.

Alternative positions "Off" or "On"
Default value "On"

Engine protection coolant temperature

Chooses whether engine protection should be activated in relation to high coolant temperature.

Alternative positions "Off" or "On"
Default value "On"

Engine protection oil pressure

Chooses whether engine protection should be activated in relation to low oil pressure.

Alternative positions "Off" or "On"

Default value "On"

Engine protection oil temperature

Chooses whether engine protection should be activated in relation to high oil temperature.

Alternative positions "Off" or "On"

Default value "On"

Primary control position

Selects the engine speed to be used when the no regulator controller is used.

Alternative positions "Isochronous" or "Droop"

Default value "Isochronous"

Pre-heating on switch-on

Parameter which selects whether automatic pre-heating should be used.

Alternative positions "Off" or "On"

Default value "Off"

Maximum engine speed

Setting of maximum engine speed

Min. value 1500 rpm

Default value 1800 rpm

Max. value 2200 rpm

Fault tracing

A number of symptoms and possible causes of engine malfunctions are described in the table below. Always contact your Volvo Penta dealer if any problems occur which you can not solve by yourself.

⚠ WARNING! Read through the safety advice for care and maintenance work in the "Safety information" chapter before starting work.

Symptoms and possible causes

* The diagnosis button lamp flashes.	Please refer to the "Diagnostic information" chapter.
Engine can not be stopped	2, 5
Starter motor does not rotate	1, 2, 3, 4, 5, 6, 7, 8, 25
Starter motor rotates slowly	1, 2
Starter motor rotates normally but engine does not start	9, 10, 11, 12
Engine starts but stops again	9, 10, 11, 12, 14
Engine does not reach correct operating speed at full throttle	10, 11, 12, 13, 14, 22, 26, 27
Engine runs unevenly	11, 12
High fuel consumption	13, 14, 16, 26
Black exhaust smoke	13, 14
Blue or white exhaust smoke	15, 16, 23
Too low lubrication oil pressure	17
Too high coolant temperature	18, 19, 20, 21
Too low coolant temperature	21
No, or poor charge	2, 24

- | | | |
|--|---|--|
| 1. Flat batteries | 11. Air in the fuel system | 20. Faulty circulation pump |
| 2. Poor contact/open circuit in cables | 12. Water/contamination in fuel | 21. Defective thermostat |
| 3. Main switch turned off | 13. Faulty unit injector | 22. Blocked intercooler |
| 4. Fuse in cable box blown | 14. Insufficient air supply to engine: | 23. Too high oil level |
| 5. Faulty ignition lock | - blocked air filter | 24. Alternator drive belt slips |
| 6. Faulty main relay | - air leakage between turbocharger and engine inlet pipe. | 25. Water entry into engine |
| 7. Faulty starter motor relay | - fouled compressor section in turbocharger | 26. High back pressure in exhaust system |
| 8. Faulty starter motor/solenoid | - faulty turbocharger | 27. Break in "Pot+" cable to pedal |
| 9. Lack of fuel: | - poor engine bay ventilation | |
| - fuel taps closed | 15. Excessive coolant temperature | |
| - fuel tank empty/wrong tank connected | 16. Too low coolant temperature | |
| 10. Blocked fuel filter/pre-filter (because of contamination, or paraffin fraction separation in fuel at low temperature). | 17. Too low oil level | |
| | 18. Coolant level too low | |
| | 19. Air in the coolant system | |

Diagnostic function

Diagnostic function

The diagnostic function monitors and checks that the EDC III system functions normally.

The diagnostic function has the following tasks:

- Discover and localize malfunctions
- Notify that malfunctions have been discovered
- Give advice in fault finding
- Protect the engine and ensure continued operation when serious malfunctions are discovered.

Malfunction message

The indicator for the diagnostic button (1) starts to flash to notify the operator if the diagnostic function discovers a malfunction in the EDC III system.

Fault tracing guide

If the diagnostic button (2) is depressed and then released, a fault code is flashed out from the diagnosis lamp (1). This is found in the fault code list, with information about the reason, reaction and measures to be taken.

The diagnostic function affects the engine in the following ways when:

1. The diagnostic function has discovered a minor malfunction which does not damage the engine.
Reaction: The engine is not affected.
2. The diagnostic function has discovered a serious malfunction which will not immediately damage the engine.
Reaction: TAD1240-42GE: Engine is shut off.
TWD1240VE: The engine is shut off or engine torque is lowered until the relevant value is normalized.
3. The diagnostic function has discovered a serious malfunction which makes it impossible to control the engine.
Reaction: TAD1240-42GE: Engine speed is retained. TWD1240VE: Engine goes to idle.

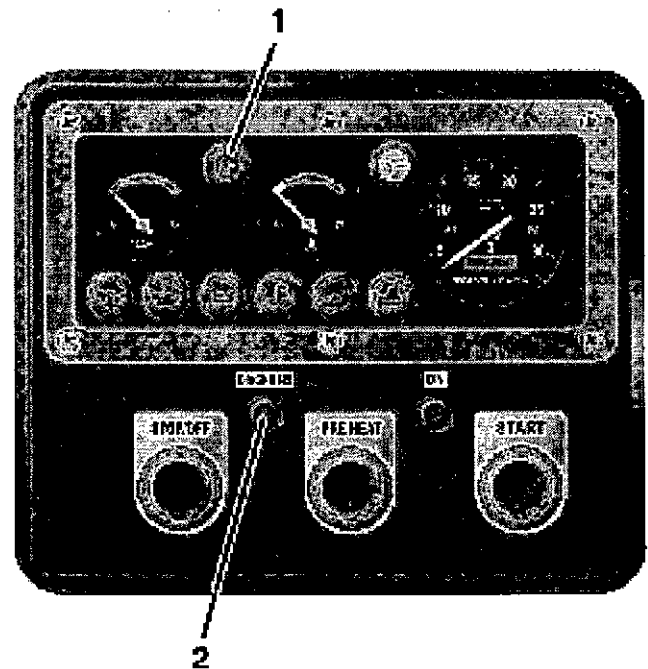

If the diagnosis button lamp flashes.

1. Reduce engine speed to idling.
2. The message is acknowledged by pressing the button (2).
3. Release the diagnostic button and make a note of the diagnostic trouble code (DTC) that is flashed out. (1) Please refer to "Reading fault codes"
4. Look up the fault code in the fault code list and take the necessary measures.

NOTE! If the warning lamps and other instrumentation show normal function, at the same time as the controls function normally, the operator can choose to continue operation and remedy the malfunction at a later time. If the engine is shut off, some fault codes may disappear

Reading fault codes

If the diagnostic button (2) is depressed and then released, a fault code is flashed out (1).

The fault code consists of two groups of flashes, separated by a pause of two seconds. A fault code is obtained by counting the number of flashes in each group.

Example: ✨ ✨ paus ✨ ✨ ✨ ✨ = Fault code 2.4

The fault code is stored and can be read as long as the malfunction remains. You can find information about Cause, Reaction and Actions in the fault code list.

Read as follows:

1. Press the diagnostic button (2).
2. Release the diagnostic button and make a note of the fault code that is flashed out (1).
3. Repeat items 1-2. A new fault code is flashed out if more are stored. Repeat until the first fault code is repeated.

NOTE! When the first fault code is repeated, all fault codes have been read out.

Erasing fault codes

The fault code memory in the diagnostic function is re-set when system voltage to the engine is shut off.

NOTE! The system voltage must be completely cut off.

When system voltage is switched on again, the diagnostic function checks to see whether there are any faults in the EDC III system. If this is the case, new fault codes are set.

This means that:

1. Fault codes for malfunctions which have been attended to or have disappeared are automatically erased.
2. Fault codes for malfunctions which have not been attended to must be acknowledged every time the system voltage is switched on.

If the diagnostic button is pressed after all faults have been attended to and stored fault codes have been erased, code 1.1 ("No fault") will be flashed out.

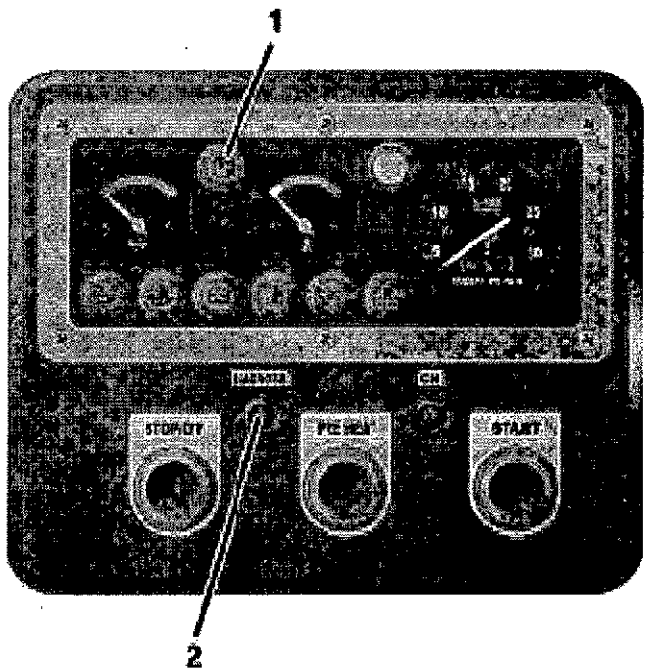

EDC III fault codes



WARNING! Read through the safety advice for care and maintenance work in the "Safety information" chapter before starting work.

175 Code 2.1

Reason: Water in fuel or too low fuel pressure.

Reaction: Alarm lamp is lit.

Action:

- Check the water trap filter (also drain the fuel tank).
- Check if it is possible to build up pressure with the hand pump.
- Check the fuel filter
- Check the fuel pre-filter

191 Code 2.2

Reason: Coolant level too low

Reaction: Engine is shut off (unless the protection has been shut off with the parameter setting tool). Alarm lamp is lit.

Action:

- Check the coolant level.
- Check coolant level monitor function.

15 Code 2.4

Reason: Speed sensor, flywheel. No signal

Reaction: Engine is very difficult to start and runs roughly when it starts.

Action:

- Check that the sensor connector is correctly installed.
- Check that the engine speed sensor cable is not damaged.
- Check that the engine speed sensor is correctly installed in the bell housing.
Check engine speed sensor function.

18 Code 2.4

Reason: Speed sensor, flywheel Abnormal frequency.

Reaction: Engine is very difficult to start and runs roughly when it starts.

Action:

- Check that the engine speed sensor connector is correctly installed.
- Check that the engine speed sensor cable is not damaged.
- Check that the engine speed sensor is correctly installed in the bell housing.
- Check engine speed sensor function.

101 Code 2.4

Reason: Speed sensor, flywheel Intermittent signal

Reaction: Engine is very difficult to start and runs roughly when it starts.

Action:

- Check that the engine speed sensor connector is correctly installed.
- Check that the engine speed sensor cable is not damaged.
- Check that the engine speed sensor is correctly installed in the bell housing.
- Check engine speed sensor function.

102 Code 2.5

Reason: Speed sensor, cam gear No signal

Reaction: Engine takes longer to start than normal. Engine runs normally when is running.

Action:

- Check that the engine speed sensor connector is correctly installed.
- Check that the engine speed sensor cable is not damaged.
- Check that the engine speed sensor is correctly installed in the upper timing gear cover.
- Check engine speed sensor function.

103 Code 2.5

Reason: Speed sensor, cam gear Abnormal frequency.

Reaction: Engine takes longer to start than normal. Engine runs normally when is running.

Action:

- Check that the engine speed sensor connector is correctly installed.
- Check that the engine speed sensor cable is not damaged.
- Check that the engine speed sensor is correctly installed in the upper timing gear cover.
- Check engine speed sensor function.

23 Code 2.7

Reason: Engine speed potentiometer connected to engine management system (EMS).

Open circuit or short circuit to positive (+).

Reaction: Engine goes to idle. If the pedal is first released and then depressed, the engine can be emergency operated by means of the idling switch.

Action:

- Check that the control connector is correctly installed.
- Check that the sensor cable is not damaged.
- Check sensor function.
- Check that the 23-pin connector is correctly installed.
- Check pin C and socket C in the 23-pin connector.

24 Code 2.7

Reason: Engine speed potentiometer connected to engine management system (EMS). Short circuit to negative (-).

Reaction: Engine goes to idle. If the pedal is first released and then depressed, the engine can be emergency operated by means of the idling switch.

Action:

- Check that the potentiometer is correctly connected.
- Check that the potentiometer cable is not damaged.
- Check potentiometer function.

21 Code 2.8

Reason: Engine speed potentiometer connected to CIU. Short circuit to negative (-).

Reaction: Engine goes to idle. If the pedal is first released and then depressed, the engine can be emergency operated by means of the idling switch.

Action:

- Check that the potentiometer is correctly connected.
- Check that the potentiometer cable is not damaged.
- Check potentiometer function.

22 Code 2.8

Reason: Engine speed potentiometer connected to CIU. Short circuit to positive (+) or open circuit

Reaction: Engine goes to idle. If the pedal is first released and then depressed, the engine can be emergency operated by means of the idling switch.

Action:

- Check that the potentiometer is correctly connected.
- Check that the potentiometer cable is not damaged.
- Check potentiometer function.

181 Code 3.1

Reason 1: Oil pressure sensor. Short circuit to positive (+).

Reaction: None.

Action:

- Check that the oil pressure sensor cable is not damaged.
- Check that the oil pressure sensor is correctly connected.

182 Code 3.1

Reason: Oil pressure sensor. Open circuit or short circuit negative (-).

Reaction: None.

Action:

- Check that the oil pressure sensor cable is not damaged.
- Check that the oil pressure sensor is correctly connected.

25 Code 3.2

Reason: Charge air temperature sensor. Open circuit or short circuit to positive (+).

Reaction: None.

Action:

- Check that the charge air temperature sensor connector is correctly installed.
- Check that the charge air temperature sensor cable is not damaged.
- Check that the charge air temperature sensor is correctly installed.
- Check charge air temperature sensor function.

26 Code 3.2

Reason: Charge air temperature sensor. Short circuit to negative (-).

Reaction: None.

Action:

- Check that the charge air temperature sensor cable is not damaged.
- Check that the charge air temperature sensor is correctly installed.
- Check charge air temperature sensor function.

27 Code 3.3

Reason: Coolant temperature sensor. Open circuit or short circuit to positive (+).

Reaction: Pre-heating is also activated when the engine is hot.

Action:

- Check that the coolant temperature sensor connector is correctly installed.
- Check that the coolant temperature sensor cable is not damaged.
- Check that the coolant temperature sensor is correctly installed.
- Check coolant temperature sensor function.

28 Code 3.3

Reason 1: Coolant temperature sensor. Short circuit to negative (-).

Reaction: Pre-heating is also activated when the engine is hot.

Action:

- Check that the coolant temperature sensor cable is not damaged.
- Check that the coolant temperature sensor is correctly installed.
- Check coolant temperature sensor function.

67 Code 3.4

Reason: Charge air pressure sensor. Short circuit to positive (+).

Reaction: Engine smokes more than normally during acceleration/load increase.

Action:

- Check that the charge pressure sensor cable is not damaged.
- Check charge pressure sensor function.

68 Code 3.4

Reason 1: Charge air pressure sensor. Open circuit or short circuit negative (-).

Reaction: Engine smokes more than normally during acceleration/load increase.

Action:

- Check that the charge pressure sensor connector is correctly installed.
- Check that the charge pressure sensor cable is not damaged.
- Check that the charge pressure sensor is correctly installed.
- Check charge pressure sensor function.

184 Code 3.7

Reason: Oil temperature sensor. Open circuit or short circuit to positive (+).

Reaction: None.

Action:

- Check that the oil temperature sensor cable is not damaged.
- Check that the oil temperature sensor is correctly connected.

185 Code 3.7

Reason: Oil temperature sensor. Short circuit to negative (-).

Reaction: None.

Action:

- Check that the oil temperature sensor cable is not damaged.
- Check that the oil temperature sensor is correctly connected.

200 Code 4.1

Reason: Oil pressure alarm, open circuit

Reaction: Alarm lamp does not work. If there is an open circuit on start-up, the diagnosis is de-activated.

Action:

- Check alarm lamp.
- Check that the alarm lamp cable is not damaged.
- Check sleeve "L" in the 23-pin connector.

201 Code 4.1

Reason: Oil pressure alarm, short circuit to negative (-).

Reaction: Alarm lamp is constantly lit.

Action:

- Check that the alarm lamp cable and connector are not damaged.

202 Code 4.1

Reason: Oil pressure alarm, short circuit to positive (+).

Reaction: Alarm lamp does not work. If there is an open circuit on start-up, the diagnosis is de-activated.

Action:

- Check that the alarm lamp cable and connector are not damaged.

35 Code 4.2

Reason: Alarm for high coolant temperature. Connected to Stand-Alone interface. Short circuit to negative (-).

Reaction: Alarm lamp is constantly lit.

Action:

- Check that the alarm lamp cable is not damaged.
- Check that the alarm lamp is correctly installed.

36 Code 4.2

Reason: Alarm for high coolant temperature. Connected to Stand-Alone interface. Short circuit to positive (+).

Reaction: Alarm lamp does not work. If there is an open circuit on start-up, the diagnosis is de-activated.

Action:

- Check that the alarm lamp cable is not damaged.
- Check that the alarm lamp is correctly installed.

226 Code 4.2

Reason: Alarm for high coolant temperature. Open circuit.

Reaction: Alarm lamp does not work. If there is an open circuit on start-up, the diagnosis is de-activated.

Action:

- Check alarm lamp for high coolant temperature.
- Check that the alarm lamp cable is not damaged.
- Check sleeve "N" in the 23-pin connector.

220 Code 4.3

Reason: Lamp for operation indication. Open circuit.

Reaction: Indication lamp does not work. If there is an open circuit on start-up, the diagnosis is de-activated.

Action:

- Check alarm lamp.
- Check that the alarm lamp cable is not damaged.
- Check sleeve "N" in the 23-pin connector.

221 Code 4.3

Reason: Lamp for operation indication. Short circuit to negative (-).

Reaction: Indication lamp is constantly lit.

Action:

- Check that the alarm lamp cable and connector are not damaged.

222 Code 4.3

Reason: Lamp for operation indication. Short circuit to positive (+).

Reaction: Indication lamp does not work. If there is an open circuit on start-up, the diagnosis is de-activated.

Action:

- Check that the alarm lamp cable and connector are not damaged.

223 Code 4.4

Reason: Alarm for high engine speed. Open circuit.

Reaction: Alarm lamp does not work. If there is an open circuit on start-up, the diagnosis is de-activated.

Action:

- Check alarm lamp.
- Check that the alarm lamp cable is not damaged.
- Check sleeve "O" in the 23-pin connector.

224 Code 4.4

Reason: Alarm for high engine speed. Short circuit to negative (-).

Reaction: Alarm lamp is constantly lit.

Action:

- Check that the alarm lamp cable and connector are not damaged.

225 Code 4.4

Reason: Alarm for high engine speed. Short circuit to positive (+).

Reaction: Alarm lamp does not work. If there is an open circuit on start-up, the diagnosis is de-activated.

Action:

- Check that the alarm lamp cable and connector are not damaged.

203 Code 4.5

Reason: Alarm for low coolant level. Open circuit.

Reaction: Alarm lamp does not work. If there is an open circuit on start-up, the diagnosis is de-activated.

Action:

- Check alarm lamp.
- Check that the alarm lamp cable is not damaged.
- Check sleeve "N" in the 23-pin connector.

204 Code 4.5

Reason: Alarm for low coolant level. Short circuit to negative (-).

Reaction: Alarm lamp is constantly lit.

Action:

- Check that the alarm lamp cable and connector are not damaged.

205 Code 4.5

Reason: Alarm for low coolant level. Short circuit to positive (+).

Reaction: Alarm lamp does not work. If there is an open circuit on start-up, the diagnosis is de-activated.

Action:

- Check that the alarm lamp cable and connector are not damaged.

41 Code 4.6

Reason: Starter relay on starter motor. Short circuit to positive (+).

Reaction: Engine can not be started.

Action:

- Check that the relay cable is not damaged.
- Check relay function.

42 Code 4.6

Reason: Starter relay on starter motor. Short circuit to negative (-).

Reaction: Engine is to be started -> Starter motor operates although no start demand was made on switch-on. Engine is running -> Starter motor operates although no start demand was made.

Engine is being started > Starter motor does not disconnect when engine has started.

Action:

- Check that the relay cable is not damaged.
- Check relay function.

107 Code 4.6

Reason: Starter motor relay. Open circuit.

Reaction: Engine can not be started.

Action:

- Check that the cable to the starter motor (yellow/black) is correctly connected.
- Check that the cable to the starter motor (yellow/black) is not damaged.
- Check that the relay on the starter motor is undamaged.

108 Code 4.7

Reason: Starter input on engine management system (EMS). Short circuit to negative (-).

Reaction: Engine can not be started.

Action:

- Check that the starter switch/starter button cable is not damaged.
- Check contact pressure in sleeve "E" in the 23-pin connector.

109 Code 4.7

Reason: Stop on engine management system (EMS). Short circuit to negative (-).

Reaction: Engine can only be stopped with emergency stop on engine.

Action:

- Check that the starter switch/starter button cable is not damaged.
- Check contact pressure in sleeve "H" in the 23-pin connector.

43 Code 5.1

Reason: Main relay. Short circuit to positive (+).

Reaction: Instrument panel is disconnected from system voltage when starter key is turned to start position. Engine can not be started.

Action:

- Check that the relay cable is not damaged.
- Check relay function.

208 Code 5.2

Reason: Start input on CIU. Short circuit to negative (-).

Reaction: Engine can not be started.

Action:

- Check that the starter switch connections are not damaged.
- Check that the starter switch cable is not damaged.

210 Code 5.2

Reason: Start input on CIU. Short circuit to plus (+) or activated for too long.

Reaction: The engine starts as soon as the ignition is switched on.

Action:

- Check that the starter switch connections are not damaged.
- Check that the starter switch cable is not damaged.

209 Code 5.3

Reason: Stop input on CIU. Short circuit to negative (-).

Reaction: Engine can only be stopped with emergency stop on engine.

Action:

- Check that the starter switch connections are not damaged.
- Check that the starter switch cable is not damaged.

211 Code 5.3

Reason: Stop input on CIU. Short circuit to plus (+) or activated for too long.

Reaction: Engine stops. A fault code is displayed for 40 seconds and the engine can not be started during this time. When a fault code is displayed on the diagnosis lamp, the engine can be started but not stopped.

Action:

- Check that the starter switch connections are not damaged.
- Check that the starter switch cable is not damaged.

214 Code 5.3

Reason: Stop input on CIU. Open circuit or activated for too long.

Reaction: Engine stops. A fault code is displayed for 40 seconds and the engine can not be started during this time. When a fault code is displayed on the diagnosis lamp, the engine can be started but not stopped.

Action:

- Check that the starter switch connections are not damaged.
- Check that the starter switch cable is not damaged.

74 Code 5.4

Reason: Pre-heating relay. Open circuit.

Reaction: Pre-heating can not be activated.

Action:

- Check that the relay input cable is not damaged.
- Check relay function.
- Check the contact pressure in socket 36 in the red connector on the engine management system (EMS).

75 Code 5.4

Reason: Pre-heating relay. Short circuit to negative (-).

Reaction: Pre-heating is constantly connected.

Action:

- Check that the relay input cable is not damaged.
- Check relay function.

76 Code 5.4

Reason: Pre-heating relay. Short circuit to positive (+).

Reaction: Pre-heating can not be connected.

Action:

- Check that the relay input cable is not damaged.
- Check relay function.

183 Code 5.8

Reason: Oil temperature is too high.

Reaction: Limited engine power (unless the protection has been shut off with the parameter setting tool). Alarm lamp is lit.

Action:

- Check oil level.
- Check oil temperature.
- Check oil system thermostat.
- Check oil temperature sensor function.

31 Code 6.1

Reason: Coolant temperature is too high.

Reaction: Engine is shut off (unless the protection has been shut off with the parameter setting tool). Alarm indication is lit.

Action:

- Check the coolant level.
- Check the intercooler (cleanliness).
- Check if there is air in the cooling system.
- Check the pressure cap on the expansion tank.
- Check coolant temperature sensor function.
- Check thermostat function.

60 Code 6.2

Reason: Charge air temperature is too high.

Reaction: Engine power limited to 50% (unless the protection has been shut off with the parameter setting tool).

Action:

- Check the coolant level.
- Check the intercooler (cleanliness).
- Check charge air temperature sensor function.
- Check thermostat function.

213 Code 6.4

Reason: Faulty data link (CAN), CIU.

Reaction: Instruments and alarm lamps stop working.

Action:

- Check that the 8-pin connector is not damaged.
- Check that the cables between the CIU and the engine management unit (EMS) are not damaged.
- Check that sleeves 11 and 12 in the connector on the CIU are not damaged.
- Check the contact pressure in sockets 1 and 2 in the red connector on the engine management system (EMS).

38 Code 6.5

Reason: Faulty data link (CAN), engine management system (EMS).

Reaction: Engine not operating: engine can not be started. Engine operating: engine idles and can only be stopped with the emergency stop.

Action:

- Check that the 8-pin connector is not damaged.
- Check that the cables between the CIU and the engine management unit (EMS) are not damaged.
- Check that sleeves 11 and 12 in the connector on the CIU are not damaged.
- Check the contact pressure in sockets 1 and 2 in the red connector on the engine management system (EMS).

105 Code 6.5

Reason: Faulty data link (CAN).

Reaction: Engine not running -> Engine can not be started. Engine running -> Engine idles and can only be stopped with the emergency stop.

Action:

- Check that the 8-pin connector is not damaged.
- Check that the cables between the CIU and the engine management unit (EMS) are not damaged.
- Check that sleeves 11 and 12 in the connector on the CIU are not damaged.
- Check the contact pressure in sockets 1 and 2 in the red connector on the engine management system (EMS).

106 Code 6.5

Reason: Faulty data link (CAN).

Reaction: Engine not running -> Engine can not be started. Engine running -> Engine idles and can only be stopped with the emergency stop.

Action:

- Check that the 8-pin connector is not damaged.
- Check that the 8-connector cable between the CIU and the engine management unit (EMS) is not damaged.
- Check that sleeves 11 and 12 in the connector on the CIU are not damaged.
- Check the contact pressure in sockets 1 and 2 in the red connector on the engine management system (EMS).

180 Code 6.6

Reason: Oil pressure is too low.

Reaction: Engine is shut off (unless the protection has been shut off with the parameter setting tool).

Alarm lamp is lit.

Action:

- Check oil level.
- Check that the air filters are not blocked.
- Check system pressure valves and safety valves in the oil system.
- Check oil pressure sensor function.

110 Code 7.1

Reason: Unit injector cylinder #1. Electrical fault.

Reaction: Engine does not run on all cylinders, unpleasant noise and reduced performance.

Action:

- Check that the unit injector cables are not damaged.
- Check that the unit injector connections are not damaged.

111 Code 7.1

Reason: Unit injector cylinder #1. Electrical fault.

Reaction: Engine does not run on all cylinders, unpleasant noise and reduced performance.

Action:

- Check that the unit injector cables are not damaged.
- Check that the unit injector connections are not damaged.

112 Code 7.1

Reason: Unit injector cylinder #1. Electrical fault.

Reaction: Engine does not run on all cylinders, unpleasant noise and reduced performance.

Action:

- Check that the unit injector cables are not damaged.
- Check that the unit injector connections are not damaged.

113 Code 7.1

Reason: Unit injector cylinder #1. Electrical fault.

Reaction: Engine does not run on all cylinders, unpleasant noise and reduced performance.

Action:

- Check that the unit injector cables are not damaged.
- Check that the unit injector connections are not damaged.

114 Code 7.1

Reason: Fault in compression or unit injector, cylinder # 1.

Reaction: Cylinder balancing is stopped -> Less even running at lower speeds and low loading.

Action:

- Check fuel supply pressure.
- Check the valve clearance.
- Check that the unit injector and connection cables are not damaged.
- Do a compression test and check cylinder # 1.

115 Code 7.1

Reason: Unit injector cylinder #1. Electrical fault.

Reaction: Engine does not run on all cylinders, unpleasant noise and reduced performance.

Action:

- Check the contact pressure in socket 11 in the black connector on the engine management system (EMS).
- Check that the unit injector cables are not damaged.
- Check that the unit injector connections are not damaged.

120 Code 7.2

Reason: Unit injector cylinder #2. Electrical fault.

Reaction: Engine does not run on all cylinders, unpleasant noise and reduced performance.

Action:

- Check that the unit injector cables are not damaged.
- Check that the unit injector connections are not damaged.

121 Code 7.2

Reason: Unit injector cylinder #2. Electrical fault.

Reaction: Engine does not run on all cylinders, unpleasant noise and reduced performance.

Action:

- Check that the unit injector cables are not damaged.
- Check that the unit injector connections are not damaged.

122 Code 7.2

Reason: Unit injector cylinder #2. Electrical fault.

Reaction: Engine does not run on all cylinders, unpleasant noise and reduced performance.

Action:

- Check that the unit injector cables are not damaged.
- Check that the unit injector connections are not damaged.

123 Code 7.2

Reason: Unit injector cylinder #2. Electrical fault.

Reaction: Engine does not run on all cylinders, unpleasant noise and reduced performance.

Action:

- Check that the unit injector cables are not damaged.
- Check that the unit injector connections are not damaged.

124 Code 7.2

Reason: Fault in compression or unit injector, cylinder # 2.

Reaction: Cylinder balancing is stopped -> Less even running at lower speeds and low loading.

Action:

- Check fuel supply pressure.
- Check the valve clearance.
- Check that the unit injector and connection cables are not damaged.
- Do a compression test and check cylinder # 2.
- Check fuel supply pressure.

125 Code 7.2

Reason: Unit injector cylinder #2. Electrical fault.

Reaction: Engine does not run on all cylinders, unpleasant noise and reduced performance.

Action:

- Check the contact pressure in socket 22 in the black connector on the engine management system (EMS).
- Check that the unit injector cables are not damaged.
- Check that the unit injector connections are not damaged.

130 Code 7.3

Reason: Unit injector cylinder #3. Electrical fault.

Reaction: Engine does not run on all cylinders, unpleasant noise and reduced performance.

Action:

- Check that the unit injector cables are not damaged.
- Check that the unit injector connections are not damaged.

131 Code 7.3

Reason: Unit injector cylinder #3. Electrical fault.

Reaction: Engine does not run on all cylinders, unpleasant noise and reduced performance.

Action:

- Check that the unit injector cables are not damaged.
- Check that the unit injector connections are not damaged.

132 Code 7.3

Reason: Unit injector cylinder #3. Electrical fault.

Reaction: Engine does not run on all cylinders, unpleasant noise and reduced performance.

Action:

- Check that the unit injector cables are not damaged.
- Check that the unit injector connections are not damaged.

133 Code 7.3

Reason: Unit injector cylinder #3. Electrical fault.

Reaction: Engine does not run on all cylinders, unpleasant noise and reduced performance.

Action:

- Check that the unit injector cables are not damaged.
- Check that the unit injector connections are not damaged.

134 Code 7.3

Reason: Fault in compression or unit injector, cylinder # 3.

Reaction: Cylinder balancing is stopped -> Less even running at lower speeds and low loading.

Action:

- Check fuel supply pressure.
- Check the valve clearance.
- Check that the unit injector and connection cables are not damaged.
- Do a compression test and check cylinder # 3.

135 Code 7.3

Reason: Unit injector cylinder #3. Electrical fault.

Reaction: Engine does not run on all cylinders, unpleasant noise and reduced performance.

Action:

- Check the contact pressure in socket 23 in the black connector on the engine management system (EMS).
- Check that the unit injector cables are not damaged.
- Check that the unit injector connections are not damaged.

140 Code 7.4

Reason: Unit injector cylinder #4. Electrical fault.

Reaction: Engine does not run on all cylinders, unpleasant noise and reduced performance.

Action:

- Check that the unit injector cables are not damaged.
- Check that the unit injector connections are not damaged.

141 Code 7.4

Reason: Unit injector cylinder #4. Electrical fault.

Reaction: Engine does not run on all cylinders, unpleasant noise and reduced performance.

Action:

- Check that the unit injector cables are not damaged.
- Check that the unit injector connections are not damaged.

142 Code 7.4

Reason: Unit injector cylinder #4. Electrical fault.

Reaction: Engine does not run on all cylinders, unpleasant noise and reduced performance.

Action:

- Check that the unit injector cables are not damaged.
- Check that the unit injector connections are not damaged.

143 Code 7.4

Reason: Unit injector cylinder #4. Electrical fault.

Reaction: Engine does not run on all cylinders, unpleasant noise and reduced performance.

Action:

- Check that the unit injector cables are not damaged.
- Check that the unit injector connections are not damaged.

144 Code 7.4

Reason: Fault in compression or unit injector, cylinder # 4.

Reaction: Cylinder balancing is stopped -> less even running at lower speeds and low loading.

Action:

- Check fuel supply pressure.
- Check the valve clearance.
- Check that the unit injector and connection cables are not damaged.
- Do a compression test and check cylinder # 4.

145 Code 7.4

Reason: Unit injector cylinder #4. Electrical fault.

Reaction: Engine does not run on all cylinders, unpleasant noise and reduced performance.

Action:

- Check the contact pressure in socket 34 in the black connector on the engine management system (EMS).
- Check that the unit injector cables are not damaged.
- Check that the unit injector connections are not damaged.

150 Code 7.5

Reason: Unit injector cylinder #5. Electrical fault.

Reaction: Engine does not run on all cylinders, unpleasant noise and reduced performance.

Action:

- Check that the unit injector cables are not damaged.
- Check that the unit injector connections are not damaged.

151 Code 7.5

Reason: Unit injector cylinder #5. Electrical fault.

Reaction: Engine does not run on all cylinders, unpleasant noise and reduced performance.

Action:

- Check that the unit injector cables are not damaged.
- Check that the unit injector connections are not damaged.

152 Code 7.5

Reason: Unit injector cylinder #5. Electrical fault.

Reaction: Engine does not run on all cylinders, unpleasant noise and reduced performance.

Action:

- Check that the unit injector cables are not damaged.
- Check that the unit injector connections are not damaged.

153 Code 7.5

Reason: Unit injector cylinder #5. Electrical fault.

Reaction: Engine does not run on all cylinders, unpleasant noise and reduced performance.

Action:

- Check that the unit injector cables are not damaged.
- Check that the unit injector connections are not damaged.

154 Code 7.5

Reason: Fault in compression or unit injector, cylinder # 5.

Reaction: Engine does not run on all cylinders, unpleasant noise and reduced performance.

Action:

- Check that the unit injector cables are not damaged.
- Check that the unit injector connections are not damaged.
- Do a compression test and check cylinder # 5.

155 Code 7.5

Reason: Unit injector cylinder #5. Electrical fault.

Reaction: Engine does not run on all cylinders, unpleasant noise and reduced performance.

Action:

- Check the contact pressure in socket 35 in the black connector on the engine management system (EMS).
- Check that the unit injector cables are not damaged.
- Check that the unit injector connections are not damaged.

160 Code 7.6

Reason: Unit injector cylinder #6. Electrical fault.

Reaction: Engine does not run on all cylinders, unpleasant noise and reduced performance.

Action:

- Check that the unit injector cables are not damaged.
- Check that the unit injector connections are not damaged.

161 Code 7.6

Reason: Unit injector cylinder #6. Electrical fault.

Reaction: Engine does not run on all cylinders, unpleasant noise and reduced performance.

Action:

- Check that the unit injector cables are not damaged.
- Check that the unit injector connections are not damaged.

162 Code 7.6

Reason: Unit injector cylinder #6. Electrical fault.

Reaction: Engine does not run on all cylinders, unpleasant noise and reduced performance.

Action:

- Check that the unit injector cables are not damaged.
- Check that the unit injector connections are not damaged.

163 Code 7.6

Reason: Unit injector cylinder #6. Electrical fault.

Reaction: Engine does not run on all cylinders, unpleasant noise and reduced performance.

Action:

- Check that the unit injector cables are not damaged.
- Check that the unit injector connections are not damaged.

164 Code 7.6

Reason: Fault in compression or unit injector, cylinder # 6.

Reaction: Cylinder balancing is stopped -> Less even running at lower speeds and low loading.

Action:

- Check fuel supply pressure.
- Check the valve clearance.
- Check unit injector and connection cables.
- Do a compression test and check cylinder # 6.

165 Code 7.6

Reason: Unit injector cylinder #6. Electrical fault.

Reaction: Engine does not run on all cylinders, unpleasant noise and reduced performance.

Action:

- Check the contact pressure in socket 35 in the black connector on the engine management system (EMS).
- Check that the unit injector cables are not damaged.
- Check that the unit injector connections are not damaged.

82 Code 9.8

Reason: Faulty EEPROM, CIU.

Reaction: CIU returns to factory setting.

Action:

- Change CIU unit.

212 Code 9.8

Reason: Faulty flash memory, CIU.

Reaction: Engine goes to idle.

Action:

- Change CIU unit.

254 Code 9.8

Reason: Controller failure, CIU

Reaction: Engine can not be started, if engine is running -> Idling.

Action:

- Change CIU unit.

255 Code 9.9

Reason: Memory fault in engine management system (EMS).

Reaction: Engine can not be started (varies).

Action:

- Change engine management system (EMS).

32 Code

Reason: Diagnostic lamp (connected to Stand-Alone interface). Open circuit.

Reaction: Diagnostic lamp does not light up on lamp test, no fault codes can be read out.

Action:

- Check that lamp is not damaged.
- Check that lamp cables are not damaged.
- Check contact pressure in sleeve "J" in the 23-pin connector.

33 Code -

Reason: Diagnostic lamp (connected to Stand-Alone interface). Short circuit to negative (-).

Reaction: Diagnostic lamp is constantly lit.

Action:

- Check that lamp cables are not damaged.
- Check that lamp is correctly installed.

34 Code

Reason: Diagnostic lamp (connected to Stand-Alone interface). Short circuit to positive (+).

Reaction: Diagnostic lamp does not light up on lamp test, no fault codes can be read out.

Action:

- Check that lamp cables are not damaged.
- Check that lamp is correctly installed.

57 Code

Reason: Charge pressure is too high.

Reaction: None.

Action:

- Check turbocharger compressor function.
- Check charge pressure sensor function.
- Check fuel volume/unit injector.

58 Code

Reason: Charge pressure is too low.

Reaction: Engine has lower performance than normal.

Action:

- Check air filter function.
- Check turbocharger compressor function.
- Check charge pressure sensor function.
- Check fuel supply pressure.

63 Code

Reason: Power supply to sensor. Short circuit to positive (+).

Reaction: Several fault codes for sensor faults.

Action:

- Check cables.

64 Code

Reason: Power supply to sensor. Short circuit to negative (-).

Reaction: Several fault codes for sensor faults.

Action:

- Check cables.

173 Code

Reason: Faulty data link (J1708), engine management system (EMS).

Reaction: Diagnostic lamp only shows internal CIU faults.

Action:

- Check that the 8-pin connector is not damaged.
- Check that the 8-conductor cable between the CIU and the engine management unit (EMS) is not damaged.
- Check that pin/sleeves 22 and 37 in the connector on the CIU are not damaged.

176 Code

Reason: Monitor for water in fuel or too low fuel pressure. Short circuit to positive (+).

Reaction: None.

Action:

- Check that the cables are not damaged.

186 Code

Reason: Memory fault in engine management system (EMS).

Reaction: Engine can not be started.

Action:

- Change engine management system (EMS).

187 Code -

Reason: Memory fault in engine management system (EMS).

Reaction: Engine can not be started.

Action:

- Change engine management system (EMS).

188 Code -

Reason: Programming plug (EOL). Short circuit to positive (+).

Reaction: Engine does not start, engine management unit (EMS) is in programming mode.

Action:

- Check that EOL connector is not jumpered.
- Check that the EOL connector cable is not damaged.

189 Code -

Reason: Programming plug (EOL). Short circuit to negative (-).

Reaction: None.

Action:

- Check that the EOL connector cable is not damaged.

192 Code -

Reason: Coolant level monitor, short circuited to positive (+).

Reaction: None.

Action:

- Check that the coolant level monitor cable is not damaged.
- Check that the coolant level monitor sensor is correctly installed.

231 Code -

Reason: Input for pre-heating request. Short circuit to negative (-).

Reaction: Pre-heating can not be activated.

Action:

- Check that the pre-heating switch cable and connector are not damaged.

233 Code -

Reason: Faulty data link (J1708), CIU.

Reaction: Diagnostic codes from engine can not be read on diagnostic lamp.

Action:

- Check that the 8-pin connector is not damaged.
- Check that the cables between the CIU and the engine management unit (EMS) are not damaged.
- Check that pin/sleeves 22 and 37 in the connector on the CIU are not damaged.

Report form

Do you have any comments or complaints about this manual? Please take a copy of this page, write your comments on it and send it to us. The address is at the bottom. We would appreciate it if you were to write in English or Swedish.

From:

.....

.....

.....

Refers to publication:

Publication no: Date of issue:

Suggestion/Motivation:

.....

.....

.....

.....

.....

.....

.....

.....

Date:

Name:

AB Volvo Penta
Teknisk Information
Avd. 42200
SE-405 08 Göteborg
Sweden

5 x Red/white cables marked T,U,V,W and X are not used.
 Green/Blue cable marked 'PREHEAT SWITCH' is not used.
 All lamps 10W max rating.

System is energised to run. Circuit to be closed during engine operation. Open circuit to stop the engine.
 Close circuit to start the engine. Open circuit when engine has started.

Close circuit to energise the system. Circuit does not have to be closed during operation but must be open while engine is stopped.

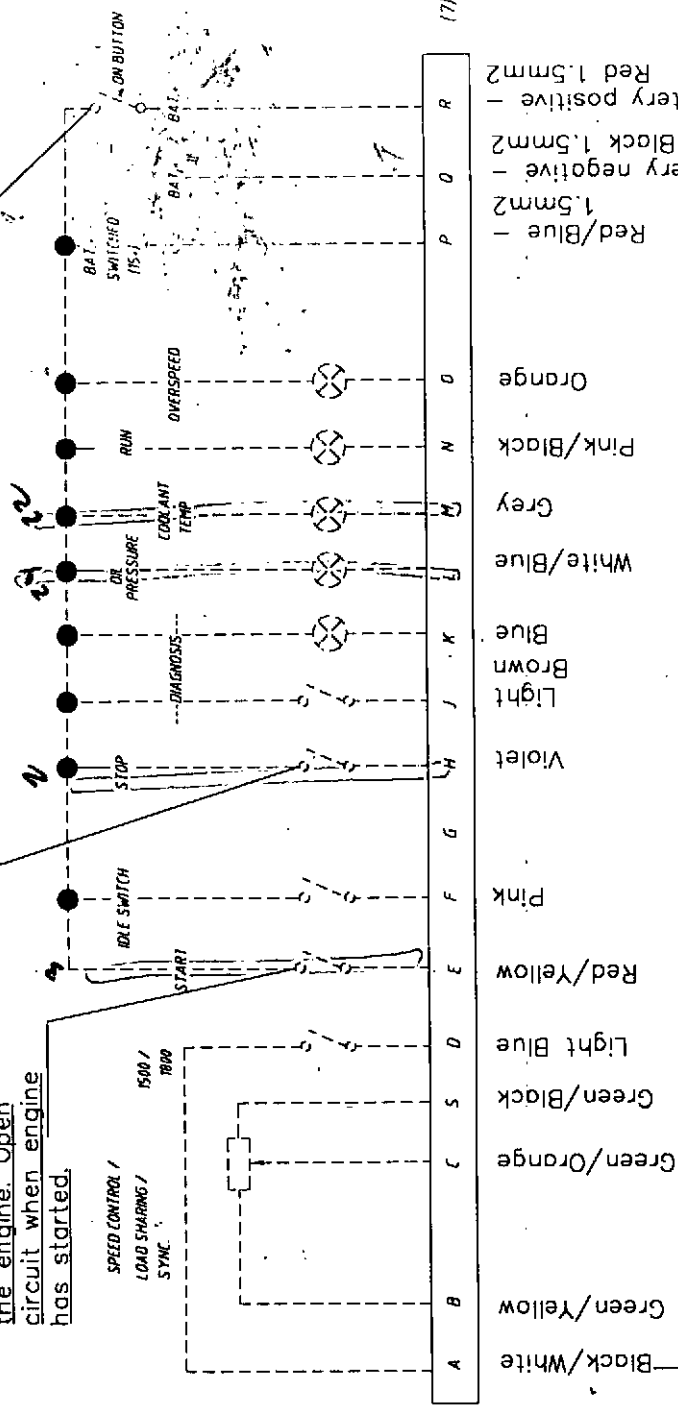

Engine wiring loom terminates with flyleads. Connection strip is OEM supply.

On early looms this was a single colour wire which was Black.

There is a positive back feed from the engine at P when the system is energised.

OEM only needs to supply leads from the battery to the starter motor terminal 30 (Positive) and 31 (Negative) to effect the permanent supply to terminals R and Q.

A	B	C	D	E	F	G	H	I	J	K	L	M	N	O	P	Q	R
Black/White	Green/Yellow	Green/Black	Light Blue	Red/Yellow	Pink		Violet	Light Brown	Blue	White/Blue	Grey	Pink/Black	Orange	Red/Blue	Permanent battery positive - Red 1.5mm ²	Permanent battery negative - Black 1.5mm ²	Permanent battery positive - Red 1.5mm ²