

SPECIAL TOOLS SPECIALVERKTYG

**MARINE AND INDUSTRIAL DIESEL ENGINES
60-61-70-71-100-120-121
MARIN- OCH INDUSTRIIDIESELMOTORER**

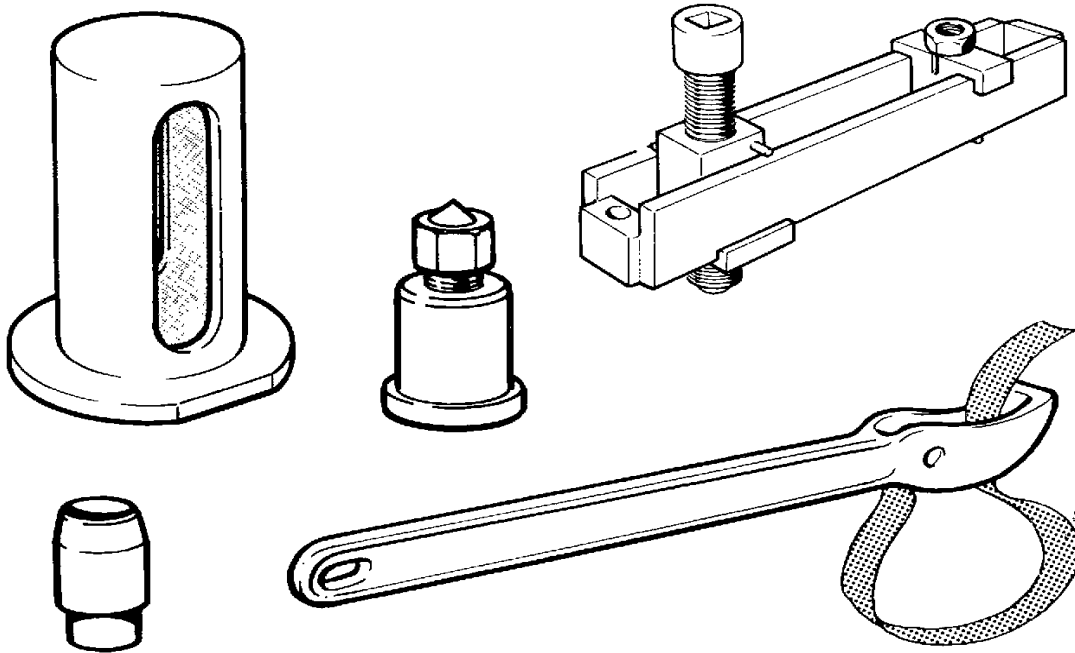

**RECOMMENDATIONS FOR VOLVO PENTA SERVICE WORKSHOPS
REKOMMENDATIONER FÖR VOLVO PENTA SERVICEVERKSTÄDER**

**VOLVO
PENTA**

Introduction

Special tools for engine types 60 to 121 All marine and industrial versions

The special tools which are included in this booklet are necessary to carry out repairs correctly. Consequently they should be a part of every authorized dealer's workshop equipment for the engine types the dealer is authorized for.

A complete instruction for the use of the special tools can be found in the workshop manuals. The special tools required by the larger workshops for rational repairs are also included in the workshop manuals.

All new special tools are announced by a Service Bulletin.

AB VOLVO PENTA
Service Department

Introduktion

Specialverktyg för motortyperna 60 till 121 Samtliga marin- och industriutföranden











Specialverktygen som finns upptagna i detta häfte är nödvändiga för ett riktigt reparationsförfarande. De skall således ingå i varje auktoriserad reparationsverkstads utrustning för de motortyper som omfattas av verkstadens engagemang.







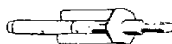



I verkstadshandböckerna finns en fullständig beskrivning av verktygens användning. Dessutom finns ytterligare specialverktyg som behövs för de större verkstäderna vid ett mera rationellt reparationsförfarande, upptagna i handböckerna.



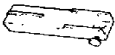







Nykonstruerade specialverktyg annonseras med en Service bulletin.









AB VOLVO PENTA
Serviceavdelningen







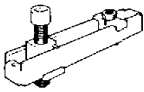

Special tools – Specialverktyg



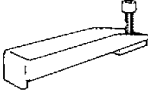



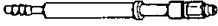



Part No Det nr	Description Benämning	Engine series				Motorserie	
		60	61	70	71	100	120-121
884679-2 (Only industrial engines) (Endast industrimotorer)	 Sleeve for fitting pulley on pump housing and for fitting roller-bearing inner ring in pulley hub, D100B, TD100A. Hylsa för montering av remskiva på kylvätskepump, samt montering av kullager i navet, D100B, TD100A.					X	
884680-0 (Only industrial engines) (Endast industrimotorer)	 Sleeve for fitting ball bearing in coolant pump, D100B, TD100A. Hylsa för montering av lager i kylvätskepump, D100B, TD100A.					X	
884690-9	 Control rod guide for setting pre-injection angle, TD60B; TAMD60B. Reglerstångsvägstopp vid inställning av förinsprutningsvinkel, TD60B, TAMD60B.	X					
884948-1	 Tool for fitting crankshaft gear. Monteringsverktyg för vevaxeldrev.		X		X		
884949-9	 Tool for fitting polygon hub on crankshaft. Monteringsverktyg för polygonnav på vevaxel.		X		X		
9989876-9	 Dial gauge. Indikatorklocka.	X	X	X	X	X	X
9992089-4	 Puller plate for cylinder liner puller. Avdragarplatta till cylinderfoderurdragare.					X	
9992178-5	 Puller plate for cylinder liner puller. Avdragarplatta till cylinderfoderurdragare.			X	X		
9992182-7	 Extractor for injector copper sleeve (for copper sleeves of early production.) Utdragare för kopparhylsa till insprutare (för kopparhylsa av tid. utf.)	X		X		X	X
9992265-0	 Puller for fan hub and pulley. Avdragare för fläktnav och remskiva.	X		X		X	X
9992266-8	 Counterhold for removing pulley. Mothåll för demontering av remskiva.	X		X		X	X

Part No Det nr	Description Benämning	Engine series				Motorserie	
		60	61	70	71	100	120-121
9992267-6	 Drift for removing and installing ball bearing in pulley, coolant pump (belt driven). Installing drift for ball bearing housing, injection pump drive. Dorn för demontering och montering av kullager i remskiva, kylvätskepump (remdriven). Monteringsdorn för kullager i lagerhus, insprutningspumpens drivordning.	X	X	X	X	X	X
9992268-4	 Drift for fitting and removing bearing and seal in circulation pump. Dorn för montering och demontering av lager och tätning i cirkulationspump.	X		X		X	X
9992269-2	 Fixture for housing when fitting pulley with bearings. Fixtur för hus vid montering av remskiva med lager.	X		X		X	X 120
9992270-0	 Drift for fitting seal in circulation pump. Dorn för montering av tätning i cirkulationspump.	X		X		X	X
9992429-2	 Press washer for removing gear bearing from shaft, circulation pump. Pressbricka för demontering av bakre lager från axel, cirkulationspump.	X		X		X	X 120
9992479-7	 Retainer for dial gauge when checking height of liner flanges above cylinder block face. Hållare för mätur vid kontroll av foderhöjd.	X	X	X	X	X	X
9992655-2	 Puller for polygon hub on crankshaft. Avdragare för polygonnav på vevaxeln.	X	X	X	X	X	X
9992656-0	 Tool for fitting polygon hub on crankshaft. Monteringsverktyg för polygonnav på vevaxeln.					X	X
9992657-8	 Tool for fitting polygon hub on crankshaft. Monteringsverktyg för polygonnav på vevaxeln.	X		X			
9992659-4	 Press tool for fitting crankshaft gear. Monteringsverktyg för vevaxeldrev.	X		X		X	X
9992661-0	 Drift for fitting valve guides. Dorn för montering av ventilstyrning.			X	X		
9992662-8	 Drift for fitting valve guides. Dorn för montering av ventilstyrning					X 100A,B	

Part No Det nr	Description Benämning	Engine series				Motorserie	
		60	61	70	71	100	120-121
9992666-9	 Press tools (2) for cylinder liners when measuring height of cylinder liner flange above cylinder block face. Pressverktyg, 2 st. för cylinderfoder vid mätning av foderkragens höjd över blockplan.					X	
9992667-7	 Press tools (2) for cylinder liners when measuring height of cylinder liner flange above cylinder block face. Pressverktyg, 2 st. för cylinderfoder vid mätning av foderkragens höjd över blockplan.	X		X			X
9992683-4	 Extractor for injectors (for injectors of early production.) Utdragare för insprutare (för insprutare av tid. utf.)	X		X		X	X
9992953-1	 Drift for fitting valve guides. Dorn för montering av ventilstyrning.						X
9992955-6	 Puller plate for cylinder liner puller. Avdragarplatta till cylinderfoderurdragare.						X
9992991-1	 Supplement for extractor 9992683-4 for KBAL-type injectors. Tillsats till utdragare 9992683-4 för insprutare typ KBAL.	X		X			X (120C)
9996008-0	 Flaring tool for injector cooper sleeves (for copper sleeves of early production.) Uppdorningsverktyg för kopparhylsa till insprutare (för kopparhylsa av tid. utf.)	X		X		X	X
9996048-6	 Milling tool for copper sleeve seats (for copper sleeves of early production.) Fräsverktyg för kopparhylsans säte (för kopparhylsa av tid. utf.).	X	X	X	X	X	X
9996066-8	 Banjo nipple with rapid-coupling for connection to a pressure gauge when checking the fuel feed pressure. Banjonippel med snabbkoppling för anslutning till en manömeter vid kontroll av bränslets matartryck.	X	X	X	X	X	X
9996087-4	 Puller plate for cylinder liner puller. Avdragarplatta till cylinderfoderurdragare.	X	X				
9996169-0	 Drift for fitting valve guides. Dorn för mont. av ventilstyrning.	X	X				

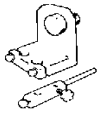
Part No Det nr	Description Benämning	Engine series				Motorserie	
		60	61	70	71	100	120-121
9996223-5	 Nipple with rapid-coupling for connection to a pressure gauge when checking the turbo supercharging pressure for industrial engines. Nippel med snabbkoppling för anslutning till en manometer vid kontroll av turbons laddtryck, industrimotorer.	X		X		X	X
9996372-0	 Tool for extraction of the copper sleeve tip. Used with 9992182-7. Utdragare för kopparhylsans tapp. Används tills. med 9992182-7.	X early prod. tid. utf.		X early prod. tid. utf.		X	X Not for 120B,F,G with lower nos than 63806. Ej för 120B,F,G med längre nr än 63806.
9996394-4	 Leg (2) for cylinder liner puller 9996645-9. Stödben (2 st.) till avdragare 9996645-9.	X	X	X	X	X	X
9996402-5	 Drift for fitting copper sleeve of new type. Dorn för motering av kopparhylsa av sen. utf.	X	X	X	X		
9996419-9	 Puller for copper sleeve ring. Utdragare för ring till kopparhylsa.	X	X	X	X	X	X
9996420-7	 Drift for fitting copper sleeve and steel ring. Dorn för montering av kopparhylsa och stålring.			X	X		
9996421-5	 Drift for fitting copper sleeve and steel ring. Dorn för montering av kopparhylsa och stålring.	X	X				
9996422-3	 Press tool for fitting copper sleeve and steel ring. Used together with 9996402-5 and 9996420-7. Pressverktyg för montering av kopparhylsa och stålring. Anv. tillsammans med 9996402-5 och 9996420-7.			X			
9996424-9	 Drift for fitting copper sleeve and steel ring. Dorn för montering av kopparhylsa och stålring.						X For 120B,F,G with lower nos than 63806. För 120B,F,G med lägre nr än 63806.
9996427-2	 Adapter for measuring compression pressure on engines of late prod. of injectors. Adapter för mätning av kompressionstryck, motorer med sen. utf. av insprutare.	X		X			X

Part No Det nr	Description Benämning	Engine series				Motorserie	
		60	61	70	71	100	120-121
9996429-8 	Press tool for fitting copper sleeve and steel ring. Used together with 9996424-9 and 9996430-6. Pressverktyg för montering av kopparhylsa och stålring. Anv. tillsammans med 9996424-9 och 9996430-6.						X For 120B,F,G with lower nos than 63806. För 120B,F,G med lägre nr än 63806.
9996430-6 	Drift for fitting copper sleeve of late prod. Dorn för nerpressning av kopparhylsa sen. utf.						X For 120B,F,G with lower nos than 63806. För 120B,F,G med lägre nr än 63806.
9996582-4 	Extractor for injectors of late production. Utdragare för insprutare av sen. utf.	X		X			
9996583-2 	Press tool for fitting copper sleeve and steel ring. Used together with 9996402-5, 9996421-5 and 9996584-0. Pressverktyg för mont. av kopparhylsa och stålring. Anv. tills. med 9996402-5, 9996421-5 och 9996584-0.	X					
9996584-0 	Counterhold for press tool 9996583-2. Mothåll för pressverktyg 9996583-2.	X					
9996643-4 	Extractor for injectors of late production. Utdragare för insprutare av sen. utf.		X		X	X 100C,G	X
9996645-9 	Puller for cylinder liners, excl. puller plate. Used together with 9996394-4. Avdragare för cylinderfoder exkl. avdragarplatta. Anv. tills. med 9996394-4.	X	X	X	X	X	X
9996647-5 	Flaring tool for copper sleeve. Uppdörningsverktyg för kopparhylsa till insprutare.					X 100C,G	X 121. 120B,F,G,H
9996650-9 	Cutter for seat for copper sleeve (late prod.). Fräsverktyg insprutare (sen. utf.).	X	X	X	X		X For 120B,F,G with lower nos than 63806. För 120B,F,G med lägre nr än 63806.
9996651-7 	Cutter for seat for copper sleeve (late prod.). Fräsverktyg insprutare (sen. utf.).	X	X	X	X		X For 120B,F,G with lower nos than 63806. För 120B,F,G med lägre nr än 63806.

Part No Det nr	Description Benämning	Engine series				Motorserie	
		60	61	70	71	100	120-121
9996657-4	 Puller for copper sleeve for injectors (late prod.). Urdragare kopparhylsa till insprutare (sen. utf.).	X	X	X	X	X 100C,G	X
9996661-6	 Mounting tool for belt pulley. Monteringsverktyg för remskiva.						X T(II)D120 T(II)D121
9996668-1	 Drift for valve guide. (Inlet). Dorn för ventilstyrning. (Inlopp).					X 100C,G	
9996669-9	 Drift for valve guide. (Exhaust). Dorn för ventilstyrning. (Utlopp).					X 100C,G	
9996682-2	 Tool for tightening of intermediate gear for circulation pump. Hylsa åtdragning mellandrev för cirkulationspump.						X T(II)D120 T(II)D121
9996847-1	 Press tools (2) for cylinder liners when measuring height of cylinder liner flange above cylinder block face. Pressverktyg (2) för cylinder foder vid mätning av foderkragens höjd över blockplan.		X		X		
9996848-9	 Tool for checking injection angle. Used together with 9989876-9. Verktyg för kontroll av förinsprutningsvinkel. Anv. tills. med 9989876-9.	X	X	X	X	X	X
9996861-2	 Press tool for fitting copper sleeve and steel ring. Used together with 9996402-5, 9996420-7, 9996421-5. Pressverktyg för mont. av kopparhylsa och stålring. Anv. tills. med 9996402-5, 9996420-7, 9996421-5.		X		X		
9996867-9	 Support when pulling out steel ring and copper sleeve. Used with 9996419-9 and 9996657-4. Underlägg vid utdragning av stålring resp. kopparhylsa. Anv. tills. med 9996419-9 och 9996657-4.		X				
9996882-8	 Adapter for measuring compression pressure. Adapter för mätning av kompressionstryck.		X		X		
9999179-3	 Tool for removing fuel and oil filter. Verktyg för demontering av bränsle- och oljefilter.	X	X	X	X	X	X

**VOLVO
PENTA**

AB Volvo Penta
Technical Publications Dept.
S-405 08 Göteborg, Sweden

Printed in Sweden by Novum Grafiska AB, Gbg, 1986