



**STARTING and  
OPERATING INSTRUCTIONS**

ISSUE MM-310

**W I S C O N S I N**

*Air-Cooled* **Engines**

**Single Cylinder – Four Cycle**

**MODELS**

**ACN, BKN**

**AENL and AGND**

**WORLD'S LARGEST BUILDERS OF HEAVY DUTY AIR COOLED ENGINES**

# NEW ENGINE Instructions

READ THOROUGHLY BEFORE STARTING ENGINE.

## 1. LUBRICATION – Operating without oil will ruin engine.

### IMPORTANT

There is **NO OIL** in this unit.  
Fill crankcase to proper oil level, also clutch or gear box if either accessory is furnished.

Refer to *GRADE OF OIL* chart and fill with proper oil *before* starting engine.

## 2. AIR CLEANER

Must be cleaned regularly – very frequently in dusty and dry grass conditions.  
*Damage will result from operating with dirty air cleaner.*

Dry element type, standard equipment on Models TRA-12D and S-14D.

Oil bath type requires same grade oil as used in crankcase. Maintain oil level or dirt will be drawn in and damage engine.

## 3. FUEL – USE 'REGULAR' GRADE GASOLINE.

Engines built to operate on FUEL OIL, KEROSENE, L.P.G. or NATURAL GAS are so identified in the model designation. Refer to 'FUEL' paragraphs of instructions.  
Buy fresh fuel. Do not use *out-of-season* gasoline.

## 4. NEGATIVE GROUND CIRCUIT

, if engine is electrically equipped with BATTERY IGNITION, MOTOR-GENERATOR or FLYWHEEL ALTERNATOR.

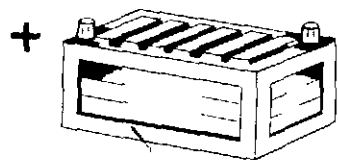

**GROUND ENGINE TO NEGATIVE TERMINAL ON BATTERY.**

*CAUTION:* Be absolutely sure of proper connection or damage to coil, points and regulator will result.

## 5. REWIND STARTER – OPTIONAL STARTING EQUIPMENT.

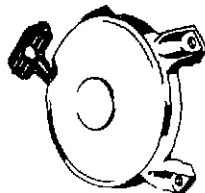

### INSTRUCTIONS FOR STARTING

Pull engine over against compression. Let rope rewind into starter slowly. Pull firmly and rapidly to start engine. (Repeat procedure if necessary). **DO NOT DROP ROPE ASSEMBLY**, hold on to handle while rewinding. *Rope may rewind improperly and jam assembly.*

## 6. TEMPERATURE SAFETY SWITCH

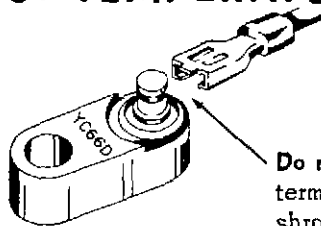

Do not disconnect wire or allow terminal to touch head fins or shrouding.

Optional accessory mounted to cylinder head bolt near spark plug – *TO PROTECT ENGINE AGAINST OVERHEATING*. If engine is equipped with this switch and stops, check first to see if engine is overheated. Other conditions may have caused engine to stop. Clean air cleaner, air intake screen, fins and check oil level, spark plugs and wiring. Let engine cool at least 10 minutes before re-starting.

## KEEP ENGINE CLEAN

External dirt restricts cooling and internal dirt causes wear – the result will be costly repairs.

### PREVENT OVERHEATING

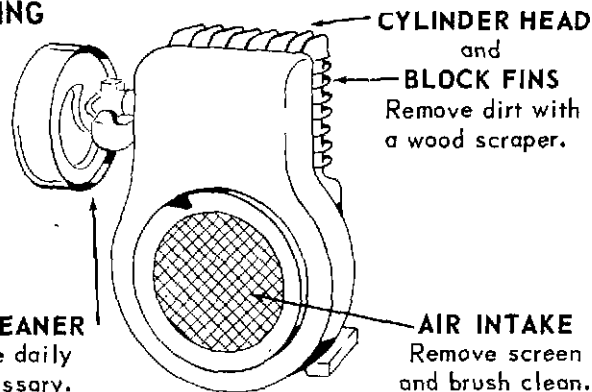

**AIR CLEANER**  
Service daily if necessary.

**AIR INTAKE**  
Remove screen and brush clean.

# WISCONSIN Single Cylinder Engine Models ACN, BKN, AENL, AGND

Engines having Stellite Exhaust Valve and Seat Insert are designated as Models ACND, BKND and AENLD.

## OPERATING NEW ENGINE

Proper breaking-in of a new engine will greatly increase its life and result in trouble-free operation. The factory test given to a new engine is not sufficient to establish the polished bearing surfaces, which are so necessary for the proper performance and long life of an engine. There is no quick way to force the establishment of good bearing surfaces, and these can only be obtained by running a new engine carefully and under reduced speeds and loads for a short period of time.

Run the engine for an hour without load, at 1600 to 1800 R.P.M. The speed should then be increased gradually, to engine operating speed, still without load, for an additional two hours. If at all possible, operate the engine at light loads for a period totaling about eight hours, before maximum load is applied.

The various bearing surfaces in a new engine have not been glazed, as they will be with continued operation, and it is in this period of "running in," that special care must be exercised, otherwise the highly desired glaze will never be obtained.

## SPECIFICATIONS and HORSEPOWER

MODEL	ACN	BKN	AENL	AGND
Bore (inches)	2-5/8	2-7/8	3	3-1/2
Stroke (inches)	2-3/4	2-3/4	3-1/4	4
Displ. (cu. in.)	14.9	17.8	23.0	38.5
R.P.M.	HORSEPOWER			
2000	3.5	4.4	6.1	10.2
2200	3.7	4.9	6.8	10.9
2400	4.2	5.4	7.4	11.5
2600	4.5	5.8	7.9	11.9
2800	4.8	6.2	8.5	12.2
3000	5.2	6.5	8.9	12.4
3200	5.6	6.7	9.2	12.5
3400	5.8	6.9	9.2	-
3600	6.0	7.0	9.2	-

Horsepower specified in the accompanying chart is for an atmospheric temperature of 60° Fahrenheit at sea level and at a Barometric pressure of 29.92 inches of mercury.

The friction in new engines cannot be reduced to the ultimate minimum during the regular block test, but engines are guaranteed to develop at least 85% of maximum power when shipped from the factory. Power will increase, as friction is reduced, after a few days of operation. The engine will develop at least 95% of power when friction is reduced to a minimum. For continuous operation, allow 20% of horsepower as a safety factor.

## ROTATION

The rotation of the crankshaft is clockwise when viewing the flywheel or cranking end of the engine. This gives counter-clockwise rotation when viewing the power take-off end of the engine. The flywheel end of the engine is designated the front end, and the power take-off end, the rear end of the engine.

**CAUTION: OIL AND FUEL HAVE BEEN DRAINED FROM THIS ENGINE FOR SHIPPING AND STORAGE PURPOSES. PREPARE ENGINE AS FOLLOWS, BEFORE STARTING.**

## LUBRICATION

THERE IS NO OIL IN THIS UNIT. Fill crankcase, clutch and gear box (if furnished), to level marks indicated, with oil classified as Service MS and per viscosity grades in oil chart.

### GRADE OF OIL CHART

SEASON or TEMPERATURE	GRADE OF OIL	EXAMPLE		
Spring, Summer or Autumn + 120°F to + 40°F	SAE 30	Mobiloil A		
Winter + 40°F to + 15°F + 15°F to 0°F Below Zero	SAE 20-20W SAE 10W SAE 5W-20	Mobiloil Arctic Mobiloil 10W Mobiloil 5W-20		
Use oils classified as Service MS				
Engine Model	Crankcase Capacity	Clutch Unit	Reduction Unit	Cl. Red. Unit
ACN, BKN	2 Pts.	1/2 Pt.	1 Pt.	-
AENL	3 Pts.	1 Pt.	2/3 Pt.	1 Pt.
AGND	7 Pts.	3/4 Pt.	1 1/2 Pts.	1 Qt.

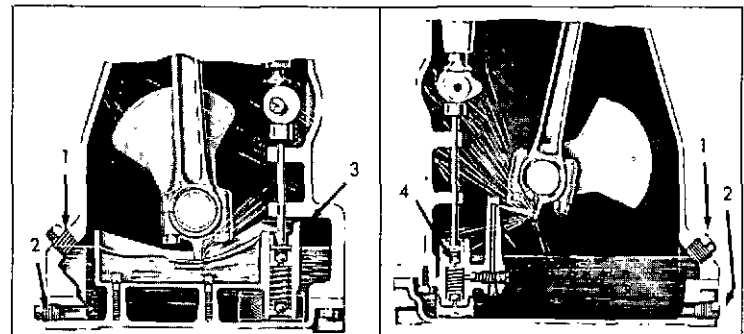

MODELS ACN, BKN, AGND

MODEL AENL

Fig. 1, LUBRICATION SYSTEMS

1. Oil filler and level plug
2. Oil drain plug
3. Oil pump - maintains level in trough for splash system
4. Oil Pump - directs oil spray against connecting rod

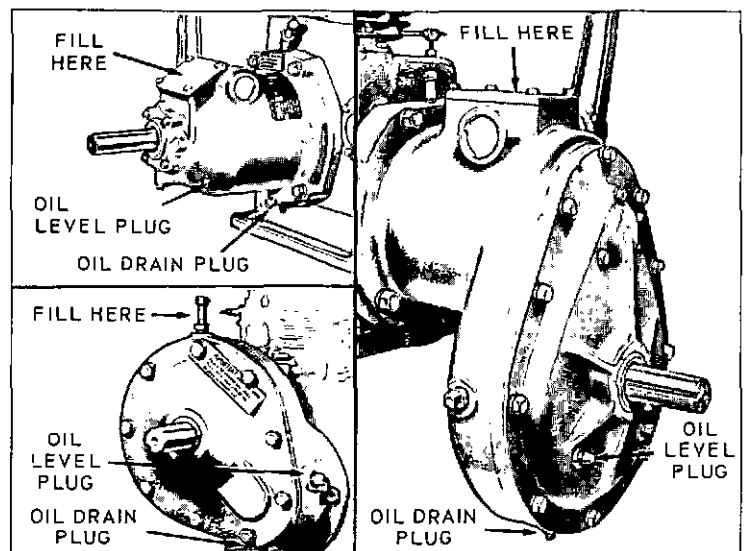

Fig. 2, USE SAME GRADE OIL IN THESE UNITS AS USED IN CRANKCASE - CHANGE EVERY 500 HOURS OF OPERATION

The crankcase capacity, specified in the 'GRADE OF OIL CHART' should be maintained at the level of the oil filler plug opening, Ref. 1 of Figures 1 and 3.

For run-in of new engines, use same oil as recommended in GRADE OF OIL CHART.

CHECK CRANKCASE OIL LEVEL EVERY 8 HOURS. CHANGE OIL EVERY 50 HOURS OF OPERATION.

### AIR CLEANER

Add oil to level line indicated on bowl of OIL BATH AIR CLEANER, Fig. 3, Ref. 3. Use same grade oil as used in crankcase.

DRY ELEMENT AIR CLEANER, is available upon request in place of oil bath cleaner - do not oil element - do not use gasoline, kerosene or solvent for cleaning.

Refer to DECAL on air cleaner body for specific maintenance instructions.

### FUEL

Regular grade gasoline.

OIL BURNING engine has letter 'O' suffixed to model designation - use 35 minimum octane fuel oil.

L.P.G. BURNING engine has letter 'G' added to model designation - use propane HD5.

NATURAL GAS burning engines require a B.T.U. content of at least 1000.

## IGNITION

### MAGNETO

The spark for ignition is furnished by a high tension magneto driven off the timing gears at crankshaft speed. An impulse coupling makes possible a powerful retarded spark for easy starting with no dangerous kick-back. Magneto timing on Page 3.

### BATTERY IGNITION-12 Volt Neg. Ground

When electric starter and generator or fly-wheel alternator are furnished battery ignition is used. Connect ground cable from negative terminal of battery to lug on starting motor. Timing on Page 4.

## STARTING

### STARTING PROCEDURE

- Check crankcase oil level and gasoline supply. Open fuel shut-off valve. OIL BURNING engines must be started on gasoline and run for 2 or 3 minutes before switching to oil. Special instructions are furnished for starting L.P.G. and NATURAL GAS burning engines.
- The HIGH SPEED NEEDLE VALVE on carburetor is adjusted when engine is tested. See 'CARBURETOR - ADJUSTMENT' for further information.
- Disengage clutch, if furnished.
- Set throttle about 1/2 open if variable speed governor control is furnished.

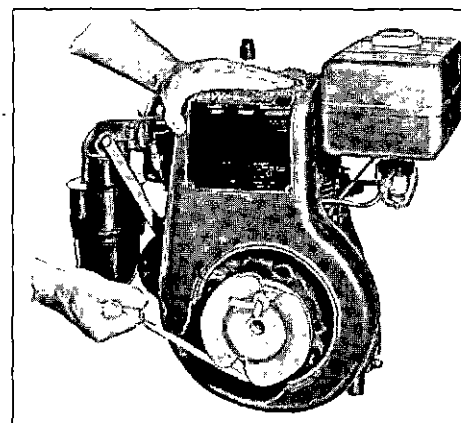

Fig. 4

- Close choke on carburetor, see Fig. 5, and crank engine over slowly one complete turn. Open choke half-way, turn engine over to compression stroke and then back off 1/2 turn. Wind rope fully on sheave and PULL BRISKLY to turn crankshaft over. See Fig. 4.

Hand crank starting is accomplished by engaging the crank and pulling up briskly in a clockwise rotation. DO NOT attempt to spin the engine with the starting crank. If the engine does not start on the first attempt, re-engage the crank and repeat the operation.

With STARTING MOTOR, pull out ignition switch, (tag reads 'TO STOP PUSH IN'), and depress starter button.

- After engine starts OPEN CHOKE FULLY. Less choking is necessary in warm weather or when engine is warm, than when cold. Should flooding occur, open choke fully and continue cranking.

If all conditions are right, engine will start promptly in one or two attempts. After engine starts, allow it to warm up a few minutes before applying load. Do not race or gun engine to hurry WARM-UP, as the proper oil film on various surfaces of the piston, cylinder, bearings, etc., cannot be established until the oil has warmed up and become sufficiently fluid.

Break-in new engine per instructions on front page of this manual.

### TO STOP ENGINE

Magneto ignition engines have a lever type ground switch on the side of the magneto. DEPRESS AND HOLD DOWN UNTIL ENGINE STOPS. See Fig. 3, Ref. 10. Engines with motor-generator or battery ignition have an ignition switch on control panel 'TO STOP PUSH IN'.

If engine has been running hard and is hot, do not stop it abruptly from full load. Cool the engine by removing the load and allowing the engine to run idle (1000 to 1200 R.P.M.), for 3 to 5 minutes.

### CARBURETOR - ADJUSTMENT, Fig. 5

The carburetor HIGH SPEED NEEDLE VALVE should be opened approximately 1/4 turns from its seat. After the engine is started and warmed up, adjust the needle valve for best operation under full load. In cold weather, starting may be facilitated by opening the needle valve slightly more, then readjusted to normal running position after engine is started.

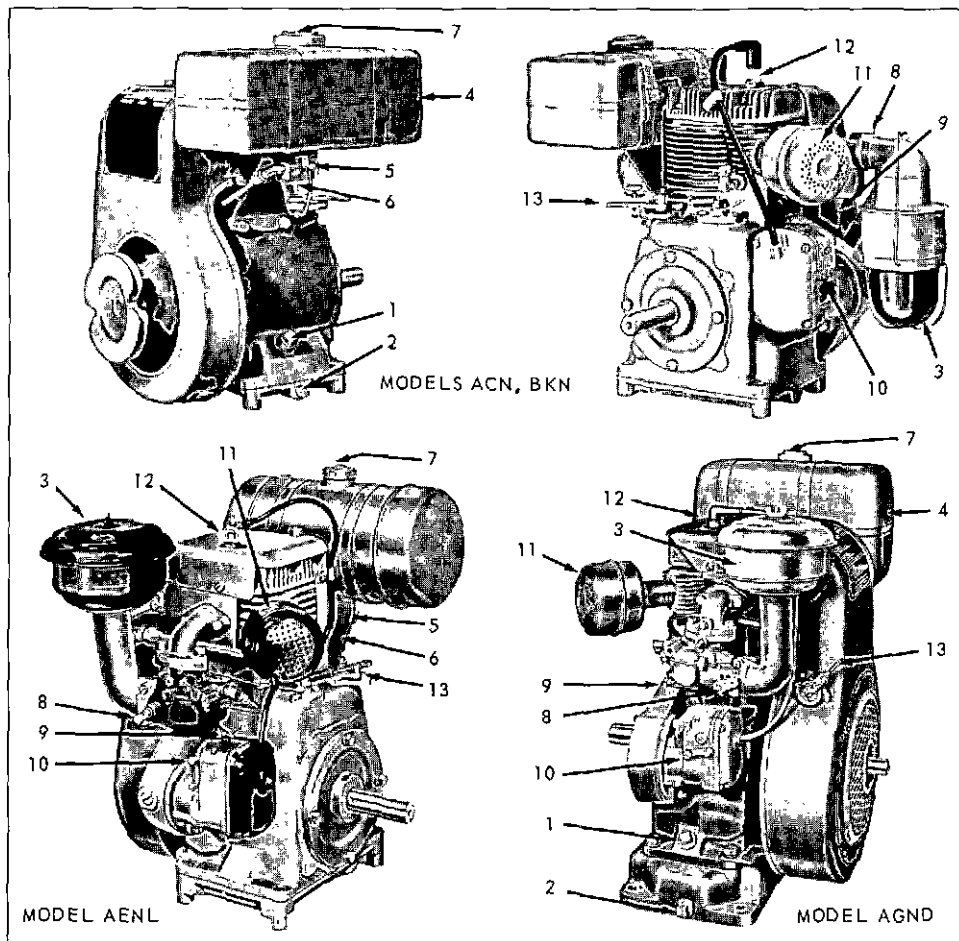
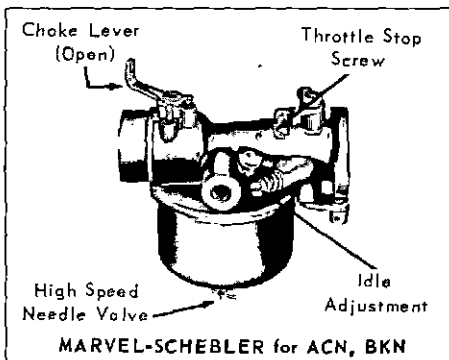
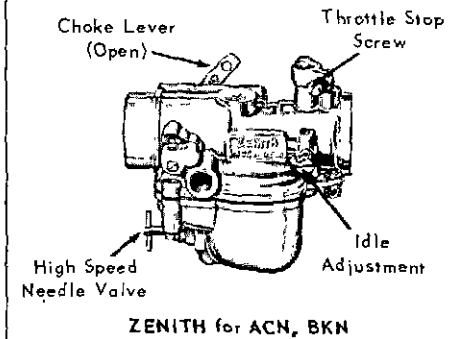

Fig. 3, ENGINE REFERENCE VIEWS

- |                              |                                       |                                     |
|------------------------------|---------------------------------------|-------------------------------------|
| 1. Oil Filler and Level Plug | 6. Glass Strainer (optional)          | 10. Magneto Stop Switch             |
| 2. Oil Drain Plug            | 7. Air Vent Hole (keep open)          | 11. Muffler                         |
| 3. Air Cleaner (oil bath)    | 8. Carburetor Choke Lever             | 12. Spark Plug                      |
| 4. Fuel Tank                 | 9. Carburetor High Speed Needle Valve | 13. Variable Speed Governor Control |
| 5. Fuel Shut-off Valve       |                                       |                                     |



MARVEL-SCHEBLER for ACN, BKN



ZENITH for ACN, BKN

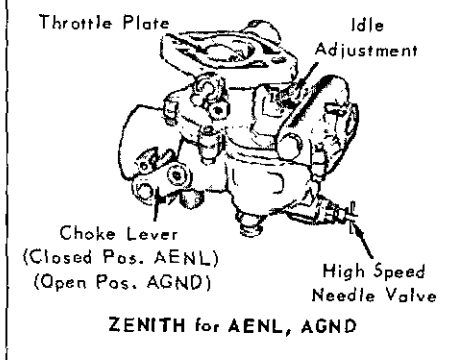

ZENITH for AENL, AGND

Fig. 5, CARBURETOR ADJUSTMENTS

The correct amount of throttle plate opening for low idle speed is obtained by means of the THROTTLE STOP SCREW. However, since this is set at the factory no immediate readjustment is necessary. The IDLE ADJUSTMENT is for smooth low speed operation and must be made with the carburetor throttle lever closed.

**SPARK PLUG, Fig. 6**

The spark plug gap should be 0.030 of an inch and plug should be kept clean both inside and out. Check spark plug gap with a wire type gauge and regap as shown.

Replacement plug must be of the correct heat range, like Champion No. D-16J or AC No. C86 com. Thread size is 18mm.

TORQUE spark plug 28 to 30 FOOT POUNDS. If torque wrench is not available, tighten plug until it begins to seat on the gasket, then turn 1/2 to 3/4 of a turn more.

**MAGNETO**

**BREAKER POINT ADJUSTMENT, Fig. 7**

At least once each season or when ignition spark becomes weak, remove magneto end cover, inspect points and check gap opening. If there is evidence of pitting or pyramiding and it becomes necessary to resurface or replace points, it will be necessary to readjust gap to its proper clearance. The BREAKER POINT GAP should be 0.015

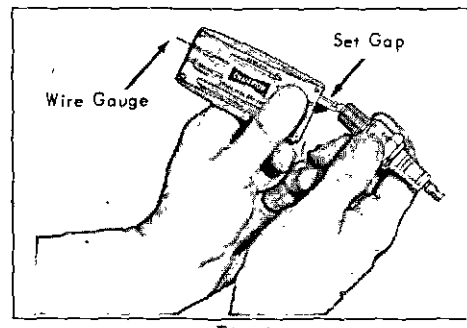

Fig. 6

inch at full separation. Turn engine crankshaft over until breaker points are at their maximum opening. Loosen the two lock-screws on breaker plate just enough so that plate can be moved. Place a 0.015 inch feeler gauge between points. Insert end of small screw driver into adjusting slot at bottom of breaker plate and open or close the contacts by moving plate until proper point gap is obtained. After tightening lock-screws, recheck breaker point gap.

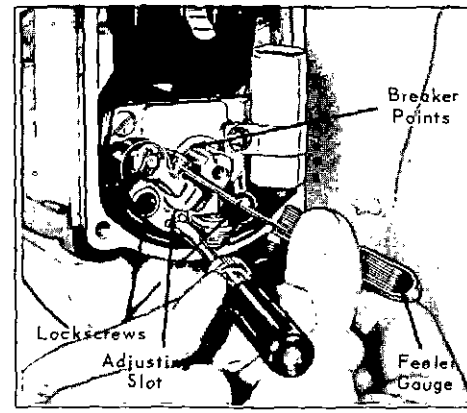

Fig. 7

**MAGNETO TIMING**

Proper mounting of the magneto is essential for correct timing. If magneto was taken off for any reason, it can be reassembled as follows: Remove spark plug and determine compression stroke by placing finger over spark plug hole while cranking engine by hand. Upon reaching compression stroke continue cranking until leading edge of the 'D-C' and 'X' marked vane on flywheel, is in line with the vertical centerline mark on flywheel shroud, as shown in Fig. 8. Leave flywheel in this position. At this point, piston is on top dead center and flywheel keyway is up.

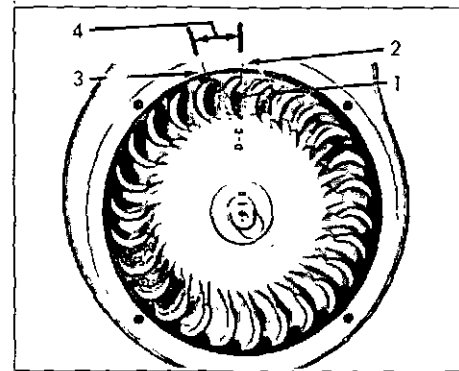

Fig. 8

- 1. Marked Flywheel Vane
- 2. Vertical Centerline Mark
- 3. Advance Mark, for Timing Light Check.
- 4. Running Spark Advance.

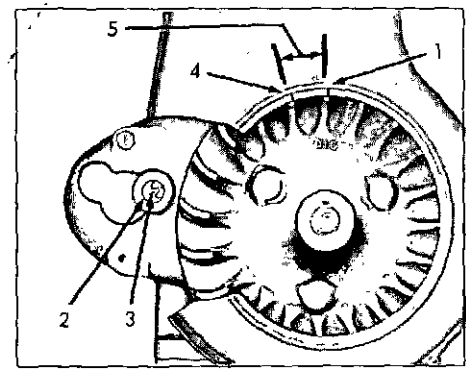

Fig. 9, ACN, BKN TIMING

- 1. Vertical Centerline Mark
- 2. Inspection Hole
- 3. Timing Marks on Mag. and Cam. Gears
- 4. Spark Advance Timing Mark
- 5. 17° Running Spark Advance

**MODELS ACN, BKN, Fig. 9**

Mount magneto so that the timing mark on face of magneto gear matches up with mark on camshaft gear as seen thru inspection hole in crankcase.

**MODEL AENL, Fig. 10**

Mount magneto to engine, meshing the gears so that when the magneto is in place, the 'X' marked tooth on the magneto gear will be visible in the center of the inspection hole of the crankcase.

**MODEL AGND, Fig. 11**

Remove plug from crankcase at take-off end. The timing mark between two camshaft gear teeth will be visible thru this opening. Mount magneto so that the 'O' marked tooth on the face of magneto gear matches up with the 'I' mark on face of camshaft gear, as seen thru inspection hole.

**ALL MODELS**

When magneto is properly timed, the impulse coupling will snap when the 'DC' marked vane of flywheel, lines up with the vertical centerline mark on flywheel shroud, while turning engine over slowly. The running spark advance for checking with a timing light is 17° for Models ACN, BKN and 20° for Models AENL and AGND.

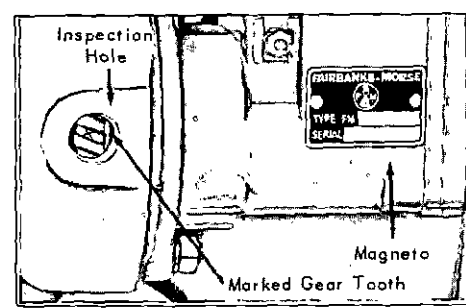

Fig. 10, AENL MAGNETO TIMING

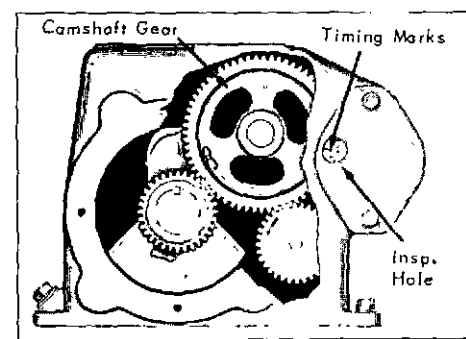

Fig. 11, AGND MAGNETO TIMING

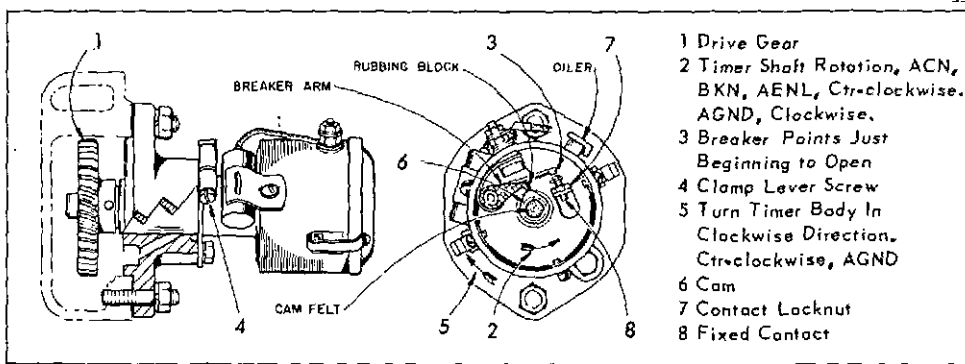

Fig. 12, IGNITION TIMER MOUNTING

## BATTERY IGNITION

**TIMING, Fig. 8 and Fig. 12**

Ignition timer is used in place of magneto when electric starter and generator or flywheel alternator is furnished.

The breaker point gap of 0.020 inch should be checked and adjusted before timer body is set and locked in place. Any change in gap opening will affect the ignition advance. To adjust gap, loosen contact locknut and screw fixed contact in or out.

Turn engine over until 'DC' and 'X' marked flywheel vane are in line with vertical centerline mark on shroud, and with piston on compression stroke, as per Fig. 8 and 'MAGNETO TIMING' paragraph.

Assuming the timer assembly is removed from the engine, turn cam, by means of drive gear, in a counter-clockwise direction (Models ACN, BKN, AENL), clockwise (Model AGND), until breaker points are just beginning to open. Mount timer assembly to engine, as illustrated in Fig. 12.

Since the running spark advance of the engine is 17° (ACN, BKN), 20° (AENL, AGND), and the timer automatic advance is 15°, an initial advance setting of 2° (ACN, BKN), 5° (AENL, AGND) must be obtained and in the following manner: With the clamp lever screw loose and breaker points just beginning to open, turn timer body: -

### MODEL ACN, BKN

Clockwise through an angle of 2° or 3/64 inch on the outside circumference of timer.

### MODEL AENL

Clockwise, 5° or about 1/8 inch in circumference of timer body.

### MODEL AGND

Counter-clockwise direction 5° or about 1/8 inch in circumference of timer body.

Tighten clamp screw, mount timer cover and connect primary wire from ignition timer to coil. If care is exercised in the preceding instructions, the spark timing should be accurate enough for satisfactory starting, however, checking spark advance with a timing light is highly recommended. Refer to Fig. 8 for spark advance marks.

The ignition timer oiler and cam felt wick should have 3 to 5 drops of medium engine oil every 100 hours of operation.

## ELECTRICAL WIRING Fig. 13, 14

The standard wiring circuits for all 12 volt electrical equipment is negative ground polarity. Engines can be furnished with start-

er and generator or combination motor-generator. Flywheel alternator is available on Models AENL and AGND.

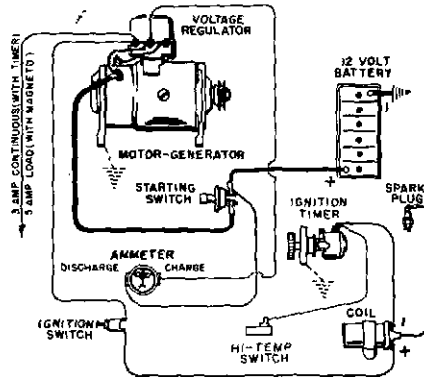

Fig. 13, MOTOR-GENERATOR WIRING

## FLYWHEEL ALTERNATOR

12 Volt - 10 Amp or 30 Amp NEGATIVE GROUND Alternator, consisting of a flywheel with Magnetic Rotor, Stator and Rectifier-Regulator module, is optional equipment on models AENL and AGND.

The flywheel alternator is of the permanent magnet type and has no brushes, commutator or belts and requires no adjustments.

PRECAUTIONS to be exercised in the use of a flywheel alternator:

1. Do not reverse battery connections. This is a negative ground system only.
2. Connect booster batteries - positive to positive and negative to negative.
3. Do not polarize the alternator.
4. Do not ground any wires from stator or modules which terminate at connectors.

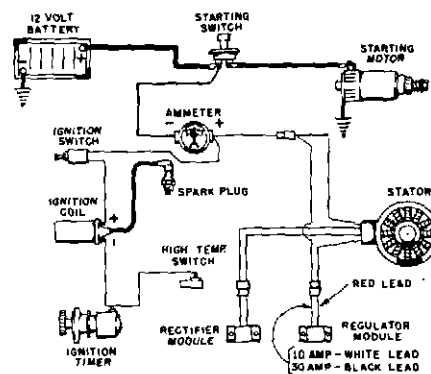

Fig. 14, FLYWHEEL ALTERNATOR

5. Do not operate engine with battery disconnected from system.

6. Disconnect at least one battery lead if a fast battery charger is used.

7. Never use a fast charger to boost battery output.

## CLUTCH ADJUSTMENT

If the clutch begins to slip, it should be readjusted to prevent it from becoming overheated and damaged. First, remove inspection plate to expose the adjusting ring. Release clutch by pushing shifter lever forward (toward engine). Refer to name plate on clutch housing to identify whether it is a TWIN DISC or ROCKFORD CLUTCH, for proper adjustment procedure.

### TWIN DISC CLUTCH, Fig. 15

Turn take-off shaft by hand until SET SCREW in the ADJUSTING RING is on top. Loosen set screw, and with a drift punch turn ring in a clockwise direction 1/4 turn at a time. The take-off shaft must be held stationary. After each movement of the ring, engage clutch. When properly adjusted, clutch will engage with a slight snap.

### ROCKFORD CLUTCH, Fig. 16

Turn engine over until clutch ADJUSTMENT LOCK is visible thru the inspection opening. Loosen ADJUSTMENT LOCKSCREW, thru PIPE PLUG HOLE, one full turn. Keep clutch from turning by holding rope sheave firmly in place. Turn ADJUSTING RING one notch at a time in a clockwise direction, until a very firm pressure is felt when operating the clutch with shifter lever, as it snaps into engaged position. Securely tighten ADJUSTMENT LOCKSCREW.

### CLUTCH REDUCTION UNITS

The clutch in the clutch reduction unit is the same as used in the power take-off unit and is adjusted in the same manner.

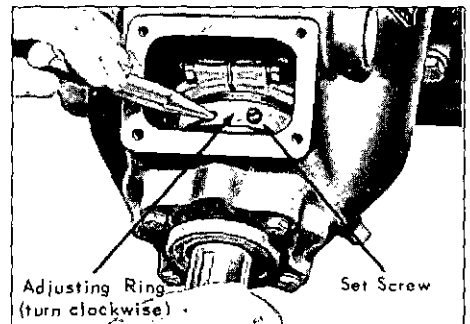

Fig. 15, TWIN DISC CLUTCH

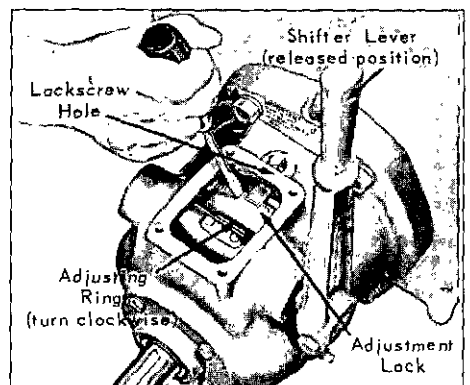

Fig. 16, ROCKFORD CLUTCH

# WISCONSIN MOTOR

## AUTHORIZED SERVICE CENTERS

The following concerns have service part stocks, facilities and trained personnel to render complete service on Wisconsin Air-Cooled Engines. We recommend you work through these service centers for your Wisconsin engine service requirements.

### \* DISTRIBUTORS

#### ALABAMA

ALBERTVILLE J. D. Chandler Cycle Co., Rt. 2 Highway 431  
 ANDALUSIA Ben Williams Equip. Co., 1344 River Falls Road  
 ANNISTON East Ala. Auto Parts Co., 909 W. 10th Street  
 ATTALLA Brown Service Co., 309 3rd. Ave. Box 130  
 BESSEMER Warlick & Miller Battery Co., 218 - 18th Street  
 BIRMINGHAM Alabama Air-Cooled Motors, 719 No. Graymont Ave.  
 Tractor & Equip. Co., Inc., 4401 1st Avenue No.  
 BOAZ Skyline Service & Supply, 113 E. Mill Ave.  
 DECATUR Tractor Equip. Co., Inc., 800 Church Street  
 DOTHAN Auto Electric Co., 118 So. St. Andrews  
 ELBA Elba Tractor Company, Route #2  
 ENTERPRISE Boyd & Company, Geneva Street  
 FLORENCE The Griffin Company, 108 East Alabama Street  
 GADSDEN Clayton Lawn Mower Shop, 138 E. Broad St.  
 HEADLAND Headland Auto Parts, 22 Main Street  
 HUNTSVILLE Auto Electric Service Co., 415 Meridian Street  
 JASPER Gaines Parts Company, 109 E. 19th Street  
 MOBILE Gravely of Mobile, Inc., 2014 Halls Mill Rd.  
 Turner Supply Company, 250 No. Royal Street  
 SIMS Service Center, P. O. Drawer A  
 MONTEVALLO 36104 \* PARTS SERVICE CO., INC., 412 Bibb Street  
 MONTGOMERY East Alabama Auto Parts, 1300 First Avenue  
 OPELIKA The Opp Shop, Route #2  
 OPP J. D. Chandler Cycle Co., 303 Willow Street  
 SCOTTSBORO Auto Parts, Inc., 19 Church Street  
 SELMA The Fix-it-shop, 1200 Ft. Lashley Ave.  
 TALLADEGA Thompson Auto Parts, 200 E. Academy Street  
 TROY Snyder's Lawnmower Shop, 401 - 34th Ave.  
 TUSCALOOSA

#### ALASKA

ANCHORAGE 99501 \* B & C Auto Electric, P.O. Box 1679  
 FAIRBANKS B & C Auto Electric, P.O. Box 1972  
 Northern Commercial Company  
 KENAI B & C Auto Electric, P.O. Box 860  
 KETCHIKAN Brougher Outboard Shop, P.O. Box 321, 1212 Tongass Ave.  
 KODIAK B & C Auto Electric, P.O. Box 383  
 PALMER B & C Auto Electric, P.O. Box 818  
 SOLDOTNA B & C Auto Electric, P.O. Box 389  
 SPENARD B & C Auto Electric, 3203 Arctic Blvd.

\* STAR MACHINERY COMPANY  
 241 Lander Street  
 Seattle, Washington 98134

#### ARIZONA

CASA GRANDE Diesel Electric Co., 917 N. Pinal Avenue  
 CHANDLER Sweet's Equipment Sales, 298 E. Galveston  
 CHINO VALLEY Chino Pump & Supply Company  
 DOUGLAS Al & Jack's Auto Elec., 247 "G" Avenue  
 KINGMAN Arthur's Sales & Service  
 NOGALES Commercial Distributors  
 PHOENIX 85002 \* PRATT-GILBERT, P.O. Box 2230, 701 So. 7th St.  
 Equipment Sales Company, 720 South 19th Avenue  
 Norton Co., 1817 E. Indian School Rd.  
 Morrison & Ledford, Inc. 733 No. 19th Avenue  
 Safford Auto Supply  
 SAFFORD Autoplane Elec. Co., 1037 South 6th Street  
 TUCSON Equipment Sales & Service Co., 2525 N. First Avenue  
 YUMA Yuma Automotive Elec., 229 - 8th St.

#### ARKANSAS

BATESVILLE Burnett & Landers  
 BENTON D. R. Bragg Implement Company, 106 S. East  
 BRINKLEY Fred Williams Welding Shop  
 CONWAY H & H Auto Parts, 417 Dak Street  
 EL DORADO Magneto Service & Supply Co.  
 FAYETTEVILLE Reed & Griffith  
 FORT SMITH George Engine Co., 3201 Midland Blvd.  
 HARRISON Tri-Lakes Motors  
 JONESBORO Jonesboro Lock & Key  
 LITTLE ROCK Industrial Equipment Service Company  
 MAGNOLIA Kelso Engine & Equipment, Inc.  
 MALVERN Malvern Saw Company, 183 North Main  
 MARIANNA Marianna Chemical & Supply Company  
 MORRILTON Industrial Equipment Service Co., 110 East Elm  
 NEWPORT Farmers Equipment Co., 101 Beech  
 NORTH LITTLE ROCK Industrial Equipment Service Co., 805 West 4th  
 PARAGOULD Hagland Repair Shop  
 PINE BLUFF Northern Saw Co. Inc., P. O. Box 701  
 SEARCY Barker Motor Company  
 Economy Motors, 811 North Maple  
 Standard Auto Supply  
 SILOAM SPRINGS Woodard Implement & Gas Engine Company, Inc.  
 1221 Magnolia at State Line  
 TEXARKANA Frazier Repair Shop, 115 Levesque

\* RCH DISTRIBUTORS, INC.  
 92 W. Carolina Avenue  
 P. O. Box 2828  
 Memphis, Tennessee 38102

\* KEELING SUPPLY COMPANY  
 E. 43rd off Hwy. 67 No.  
 P. O. Box 778  
 North Little Rock, Arkansas

#### CALIFORNIA

ALHAMBRA Ja R Engine & Supply, 1819 W. Valley Blvd.  
 ALTURAS Modoc Ford Tractor & Implement Co., P.O. Box 1669  
 ANAHEIM Superior Equipment Rental & Sales, 1266 E. Lincoln St.  
 ANDERSON Taylor Auto Parts, 2820 W. Center Street  
 ARCATA Brizard-Matthews Machy. Co., 1219 Eleventh Street  
 BAKERSFIELD Janca Pump & Engine Company, 2601 M Street  
 BISHOP Black's Machine Shop, 169 Willow St.  
 BLYTHE Cax & Summers Small Engines, 201-1/2 N. Lovekin  
 BRAWLEY Valley Auto Supply Co., 535 "E" Street  
 BRENTWOOD United Auto Supply, 118 Oak Street  
 BURBANK R. J. Lison Co., 3800 Riverside Drive  
 BUTTONWILLOW B. W. Implement Co., Box 'B'  
 CHICO A. J. Baradari, 287 Humboldt Avenue  
 Jeffery Brothers, 2260 Park Avenue  
 COLUSA Kenneth I. Schwartz & Son, 115 5th Street  
 I. G. Zumwalt Company, 850 Market St.  
 COMPTON Penrose Machine Co., 12903 Atlantic Blvd.  
 CONCORD Garden Equipment Company, #10 Meadow Lane  
 CORCORAN Sawtelle & Rosprim, P.O. Box 38  
 DELANO Delano Repair Service, 1601 Glenwood St.

**DOWNEY** Downey Mower & Saw Co., 10248 S. Paramount Blvd.  
Emergency Engine Service, 8117 Phlox St.

**EL CENTRO** Valley Auto Supply, 633 State Street

**EL MONTE** Standard Engine & Equip. Co. Inc.,  
12231 E. Garvey Avenue

**EMERYVILLE** 94608 \* E. E. RICHTER & SON, INC.,  
6598 Hollis Street

**ESCONDIDO** The Rix Company, 1719 64th Street

**EUREKA** Palomar Tractor Co., 1350 Mission Rd.

**FIVE POINTS** Rogers Machinery Co., Inc., 3428 Jacobs Avenue

**FREMONT** Sasser Tractor Co., 21350 Lassen Ave., P.O. Box 428

**FRESNO** Centerville Saw & Tool Works, 36848 Fremont Blvd.  
Contractors Equipment & Supply, 1454 North Clark  
Jensen & Pilegard, 2510 Blackstone Avenue  
Schedler's Engine Rebuilding, 624 Broadway  
J M Service, 11552 Anabel

**GARDEN GROVE** Lampson Tractor & Equipment Company, P.O. Box 336

**GEYSERVILLE** Acme Rents, 1855 S. Brand Blvd.

**GLENDALE** Ambrose Carburetor & Electric Service, 1091 Hazel

**GRIDLEY** Hanford Fair Supply Co., 309 E. 7th Street

**HANFORD** Steve's Auto Parts, 129 S. Inez

**HEMET** Wiebe Manufacturing, Inc.,  
1131 San Felipe Road - P.O. Box 639

**HOLLISTER** Freeman Baler Sales & Service, 622 E. 5th Street

**HOLTVILLE** Suski & Sakemi Garage, Drawer "SS", 81-385 Hwy. 111

**INDIO** W.K. Equipment Company, 83-525 Date Street

**KERMAN** Kerman Motor Parts, 662 South Madera St.

**KING CITY** Livingston Bros. Tractor Co., 101 Highway North

**LAKEPORT** Lake Parts Service, 120 Main St.

**LANCASTER** Brandt Bros., 379 West Avenue I

**LODI** Wright's Garage, 214 N. Sacramento Street

**LOMPOC** Aceco Equipment Co. Inc., 321 North "G" Street

**LONG BEACH** Smith & Thorp, Incorporated, 141 E. Anaheim Street

**LOS ANGELES** 90252 \* LANCO ENGINE SERVICES, INC.  
12915 Weber Way (Hawthorne)  
Carburetor Electrical Service, 1904 East Seventh Street

**LOS BANOS** Zentner Tractor, P. O. Box 1192

**MADERA** Roy's Madera Cyclery, 200 North "F" Street

**MANTECA** Goodwin Equipment Service, P.O. Drawer 671

**MARYSVILLE** Middleton Implement Company, 600 Third Street

**MERCED** Laird Welding & Mfg. Company, 5315 Las Bonos Hiway

**MODESTO** Stanislaus Impl. & Hardware Company, 10th & 'F' Sts.  
Willingers Automotive Clinic, 1125 "G" Street

**MONTCLAIR** Wolfe & Sons Sales, 10611 Ramona Avenue

**MONTEBELLO** S & A Engine Sales & Service, 1513 Olympic Blvd.

**MONTEREY** Bradys Repair, 856 Lighthouse Avenue

**NAPA** Bert Williams & Son, 831 First Street

**NORTH HOLLYWOOD** Oliphant Bros., 13261 Satcoy St.

**NOVATO** Mac's Saw Service, 707 Grant Avenue  
Novato Equipment & Service, 1054 First Street

**OAKLAND** H. V. Carter Co., Inc., 1700 East 14th St.

**ORLAND** Holt Service Shop, 419 Colusa Street  
Joe & Elwins Repair, Route 1, Box 42B

**ORO GRANDE** McVey-McCarter Machy., Box 88, 12972 Old Hwy. 66

**DROVILLE** Oroville Truck Parts & Equip., Inc., Highway 40 A South

**OXNARD** Maulhardt Equipment Co., 815 N. Oxnard Blvd.

**PALM SPRINGS** Logan Sons, 3255 East Palm Canyon Drive

**PASO ROBLES** H. A. Wood Welding & Machine Shop, 1207 - 13th Street

**PETALUMA** Holm Tractor & Equip't. Co., 110 Howard St.

**PICO RIVERA** Rental Yard Supply Co., 7815 Paramount Blvd.

**PORTERVILLE** Porterville Farm Implement Co., 428 S. Main Street

**QUINCY** The Power House, P.O. Box 416

**RED BLUFF** Red Bluff Auto Electric, 938-1/2 Washington St.

**REDDING** Gerlinger Steel & Supply Co., 1527 Sacramento

**REDWOOD CITY** E & H Engineering & Equipment, 816 Hurlingame Ave.

**REEDLEY** Growers Supply Company, 953 "G" Street

**RESEDA** Tarzana Mower & Engine Co., 6075 Reseda Boulevard

**RIO VISTA** Gordon-Hansen Company, Limited  
Front and Sacramento Streets

**RIVERSIDE** W. K. Equipment Company, 3035 Chicago Avenue

**SACRAMENTO** Bar-Hein Tractor Co., 1551 Fulton Avenue  
Gerlinger Motor Parts, 2020 Kay Street  
Munz Pumps, Inc., 301 N. 12th St.

**SALINAS** Salinas Automotive Service, 865 Abbott Street

**SAN BERNARDINO** Ray's Equipment Rentals, 24996 Base Line  
W. K. Equipment Co., 275 South "E" Street

**SAN CARLOS** Wrigley Pump Co., 750 Industrial Rd.

**SAN DIEGO** Webb Farm Equipment Co., 940 'K' Street

**SAN FRANCISCO** The Rix Company, 625 Bayshore  
San Francisco Engine Re-Manufacturing  
164 - 14th Street

**SAN JOSE** Air Cooled Engines, 1073 North 10th Street  
Krank Machine & Mfg. Co., 566 W. Julian Street  
Frank's Ignition, 289 Park Street

**SAN LEANDRO** Francis C. Mueller, 198 South St.

**SAN LUIS OBISPO** Bennie's Inc., 178 South Boulevard

**SAN MATEO** James Requarth Engines, 111 N. Spurgeon Street

**SANTA ANA** Martin DePiazzi Automotive Service, Inc.,  
118 East Ortega Street

**SANTA BARBARA** Santa Barbara Diesel Service, 29 State St.  
C & J Equipment, 2301 Lafayette

**SANTA CLARA** Kelly's Service, 516 Front Street

**SANTA CRUZ** Webb Farm Supplies, 5381 Old. Soquel-San Jose Rd.  
Nickson's Machine Shop, 914 W. Betteravia Rd.

**SANTA MARIA** P. D. Bahn & Sons, 1543 Lincoln Blvd.

**SANTA MONICA** Santa Paula-U-Rent, 614 East Harvard

**SANTA PAULA** Freeman Tractor Co., 1015 Petaluma Hill Road

**SANTA ROSA** Harry B. Trembley, Inc., 3rd & B Streets  
Yonkers & Johnson, P.O. Box 97

**SOUTH DOS PALOS** Valley Engine Shop, 1402 East Miner Avenue

**STOCKTON** Tasco Auto Parts, 306 Center St.

**TAFT** Sasser Tractor Company, P.O. Box 691  
E. Highway 50 at Chrisman Road

**TRACY** Linder Equipment Company, 311 East Kern Street

**TULARE** Floyd A. Boyd Company

**TULE LAKE** Holz Company, Clay at Railroad

**UKIAH** Gem Equipment Co., P. O. Box 1059, 171 Stanley

**VENTURA** W. K. Equipment Co., 14820 - 7th Street

**VICTORVILLE** Charles J. Hammer Mch. Co., 915 E. Main

**VISALIA** Wasco Farm Equipment Co., 1345 "G" Street

**WASCO** P & G Auto Repair

**WATSONVILLE** Whittier Motor Parts, 7308 S. Greenleaf

**WHITTIER** I. G. Zumwalt Company, 311 N. Butte St.

**WILLOWS** Middleton Implement Company, Knight's Landing Hiway

**WOODLAND** Woodland Tractor Company, Kentucky Avenue  
Littrell Parts, 310 S. Main Street

**YREKA**

## COLORADO

**ALAMOSA** Sorum Tractor

**ALTURAS** Modoc Ford Tractor & Implement Co., P. O. Box 1669

**BOULDER** A-1 Auto Supply

**BRUSH** Farmer's Elevator Company

**BURLINGTON** McArthur Impl. Company

**COLORADO SPRINGS** Goff Wilkins Marine Co.

**CORTEZ** Helms Implements, Inc., Box 68

**CRAIG** Redmon Sales & Service, 845 E. Victory Way

**DELTA** Hinton Auto Electric

**DENVER** 80216 \* CENTRAL EQUIPMENT CO., 4477 Garfield Street  
Barter Machinery & Supply Co., 215 South Santa Fe  
Booth-Rouse Equipment Co., 5700 Eudora Street  
The Engine Clinic, 4825 E. Evans Ave. (10)  
Power Rental Equipment Co., 3440 Brighton Blvd.  
Rental Machinery Co., 870 South Lipan Street  
Superior Engine Service  
Western States Machinery, 2400 W. 7th

**DURANGO** Telluride Iron Works, Inc.

**EL MONTE** Standard Engine & Equip. Co. Inc.,  
12231 E. Garvey Avenue

**FLAGLER** Flagler Farm Equipment Co.

**FORT COLLINS** McClure & Son, Box 547, E. on Hiway 14

**FT. LUPTON** Whittman Implement Co.

**FT. MORGAN** Sailshery Supply Co.

GLENWOOD SPRINGS Berthod Motors, 10th & Grand  
 GRAND JUNCTION Plateau Equipment & Supply  
 Western Implement Co. Inc., 2919 North Avenue  
 GREELEY Thomas Fay Implement Co., 821 - 7th Street  
 KEENSBURG Peery Motor & Equipment Co.  
 LAMAR Motor Supply  
 LAS ANIMAS Bent County Motors  
 LIMON Groff Equipment Co.  
 LONGMONT Kats Implement Company  
 Longmont Farm Supply  
 LOVELAND Geo. A. Walker Implement Co.  
 MONTE VISTA Gair Auto & Tractor Supply, 132 Washington  
 PUEBLO Pueblo Motive Company  
 RIFLE Rifle Auto Parts  
 STERLING Stillman Auto Electric, 517 W. Main  
 WRAY Wray Farm Equipment

**CONNECTICUT**

BRIDGEPORT The Arnold Company, 3225 Fairfield Avenue  
 L. T. Dobby, Inc., 2091 Fairfield Avenue  
 DANBURY Peerless Enterprises, RFD #4  
 HARTFORD McCallum Motor Service, Box 2009  
 MANCHESTER Capitol Equipment Company, 38 Main Street  
 NEW FAIRFIELD Peerless Repair Service, RFD #4  
 NEW HAVEN W. I. Clark Company, P. O. Box 301  
 NEW LONDON Creem Automotive Service, Inc., 20 Truman Street  
 TORRINGTON Bartram Auto Elec. Co. Inc., 176 E. Main St.  
 WATERBURY Contractors Supply Company, Inc. East Aurora Street  
 WETHERSFIELD 9 F. C. Matteson, 450 Silas Deane Hwy.  
 WINDSOR LOCKS The Magovern Company, Inc., Lawn Acre Road  
 \* JOHN REINER & COMPANY  
 94-15 150th Street  
 Jamaica, New York 11435

**DELAWARE**

BRIDGEVILLE O. A. Newton & Son Co.  
 DOVER Cox Motor Shop, 1261 South Governors Avenue  
 WILMINGTON Equipment & Service Co., 1330 Thatcher Street  
 F. M. Yearsley, 3600 Mill Creek Rd.  
 \* JOS. L. PINTO  
 5918 Baltimore Ave.  
 Philadelphia, Pennsylvania 19143  
 \* POTTER EQUIPMENT COMPANY  
 6200 N. Capitol Street, N.W.  
 Washington, D. C. 20011

**DISTRICT of COLUMBIA**

WASHINGTON, D.C. 20011\* POTTER EQUIP. CO., 6200 N. Capitol St., N.W.  
 Hudson Sup. & Equip. Co., 9th & Brentwood Rd. N.E.  
 Tri-State Auto Parts, P. O. Box 5035

**FLORIDA**

AVON PARK Don's Mower Sales & Service, 798 S. Verona  
 BELLE GLADE Glades Equipment Co., P.O. Box 428  
 BRADENTON Guarantee Electric, 701 - 9th St., W.  
 CLEWISTON Bill Norman's Goodyear Store  
 COCOA Rev-Cut Mower Co., 2005 N. Cocoa Blvd.  
 DADE CITY Standard Auto Parts  
 DAYTONA BEACH Seager Lawn Mower Shop, 801 N. Beach St.  
 DeLAND DeLand Saw Sales & Service, 319 E. Voorhis Ave.  
 EAU GALLIE Eau Gallie Tool Rentals, 1389 Cypress Avenue  
 FLORENCE VILLA Growers Service Company  
 FORT LAUDERDALE Coastal Equipment Co., 5500 N.W. 22 Ave.  
 Dela Corporation, 241 S. W. 21 Terr  
 L. B. Turf Equip., Inc.

FORT MYERS Davies Cycle Center, 1407 Citrus Street  
 FORT PIERCE Minton Equipment Company, P. O. Box 270  
 GAINESVILLE Myers Power Tools, 239 E. 16th Avenue  
 HAINES CITY Lemon & Son, Inc.  
 HIALEAH Daves Lawnmower Shop, 122 West 23 St.  
 HOLLYWOOD Terrill Motors & Machinery, 2057 Taft Street  
 JACKSONVILLE 32206\* MARINE INDUSTRIAL EQUIPMENT CORP.,  
 P. O. Box 39, Station G, 710 Haines Street  
 American Universal Contractors Service, Inc.  
 2922 St. Augustine Road  
 Julien P. Benjamin Equipment Co., 2300 McCoys Blvd.  
 Nichols Equipment, 10237 Beach Blvd.  
 Ware Nurseries & Garden Supply, 5497 Timaquana Road  
 Power Mower Sales & Service, Inc.  
 Lloyd & Son, Route 1 Box 41, U.S. No. 90 East  
 Lakeland Motor Parts  
 Boyte Auto Supply Co.  
 Gordon F. Belcher  
 Tucker Heavy Equipment Co., P. O. Box 884  
 Tyre's Saw and Engine Service, 905 5th Street, N.W.  
 West Florida Equipment Co., Highway 90 West  
 \* P. H. NEFF & SONS, INC., 7270 Northwest 41st Street  
 Mason Kwip, Inc., 7270 N. W. 42 Street  
 Small Engine Sales & Service  
 Whirler Glide Mower Co.  
 Carrara Lawn Equipment Center, 997 Third Ave., North  
 Bassler's Garage  
 Link Brothers  
 \* HIGHWAY EQUIP. & SUPPLY CO., 1016 West Church St.  
 Herold & Miller Equipment Co., 102 West Grand Ave.  
 Wiggins Auto Parts, Inc., 116 W. 15th Street  
 Cal's Tractor & Mower Service, 4404 Lillian Highway  
 Killinger Marine, 713 So. Palafox Street  
 Plant City Motor Parts, 209 E. Reynolds Street  
 Bugeski Sales & Service, 62 San Marco Blvd.  
 Melvin's, Inc.  
 Swift Weed Cutter, 326 22nd Ave. N.  
 Smitty's Snappin' Turtle Garage, P. O. Box 28  
 Standard Auto Parts  
 Hunter Auto Supply, 210 South Albany Ave.  
 Baker Alford Company, 208 N. Adams St.  
 \* INDUSTRIAL SUPPLY CORP., 1800 2nd Avenue  
 Frederiksen Enterprises, 5606 S. MacDill Avenue  
 M. D. Moody & Sons, Inc., 6001 Hillsboro Ave.  
 S & G Auto Supply Company, 3007 North 50th Street  
 Brevard Tractor Company, Route #1, Box 83B  
 Lake Oliver Tractor Sales & Service, 431 N. Central  
 Neely's Repair Shop, 1966 Commerce St.  
 Wilson-Tindell Pump & Supply Company  
 Griffin Equipment Inc., 4115 Georgia Avenue  
 Jim's Equipment Co., 530 East Hwy. 50

\* PARTS SERVICE COMPANY, INC.  
 412 Bibb Street  
 Montgomery, Alabama 36104

**GEORGIA**

ALBANY Blalock Mach. & Equip. Co., Inc., 105 S. Slappey Drive  
 ASHBURN Odom Implement Company  
 ATHENS Carter's Carburetor & Elec. Co., 940 W. Broad St.  
 ATLANTA 30302 \* BLALOCK MACHINERY & EQUIPMENT CO., INC.,  
 225 Forsyth St., S.W.  
 W. C. Caye Company, 787 Windsor Street S.W.  
 Stovall & Company, 948 Bankhead Avenue  
 AUGUSTA W. C. Caye & Co., Inc., 1468 Gordon Hwy.  
 Rex Auto Parts Co., 1233 Gordon Park Road  
 BLACKSHEAR Nimmer Tractor & Implement Company  
 BRUNSWICK Brunswick Battery & Electric Company  
 COLUMBUS Columbus Tractor & Machinery Company, 315 Andrews Rd  
 CORDELE Georgia Implement & Truck Company  
 DALTON J. E. Pitts Garage & Machine Shop, 105 West Waugh St.

DECATUR Shaw Equipment Co., Inc., 3858 Glenwood Rd.  
DONALSONVILLE Harvey Implement Co.  
DUBLIN Dixie Farm Equipment  
EAST POINT Merritt Equipment Service, Inc.,  
1515 Central Avenue, P. O. Box 885  
EDISON Duke Farm Equipment Company  
FITZGERALD Martin Manufacturing Company, P.O. Box 389  
GAINESVILLE Slack Auto Parts Co., 404 S. Main Street, P.O. Box 676  
HAZELHURST Miles Fabricating & Machine Shop, 220 Latimer St.  
MACON Forrestry Equipment Company, 4385 Pio Nona Ave.  
ROME Shorter Ave. Lawn Mower, 1946 Shorter Ave.  
SANDERSVILLE Riner Radiator & Battery Company, P.O. Box 235  
SAVANNAH Jones Equipment Company  
Wilbur M. Ward Co., Inc., 1945 52nd Street Ext. W.  
TIFTON R. E. Carmichael & Company  
VALDOSTA Schroer Implement Company  
VIDALIA Sea Island Cotton Gin Company, 403 N.W. Main Street  
WAYCROSS Waycross Battery & Electric Company, 611 Albany Ave.

\* NIXON MACHINERY & SUPPLY COMPANY  
1300 Carter Street  
Chatanooga, Tennessee 37401

### HAWAII

HONOLULU 96819 \* LANCO ENGINE SERVICES, INC.,  
3180 Ualena Street

### IDAHO

BLACKFOOT Kaps Warehouse  
BOISE 83707 \* ARNOLD MACHINERY CO. INC., 111 East 39th Street  
BURLEY Bill Jones Automotive  
CALDWELL B & M Equipment Co.  
EMMETT Valley Pump & Equipment Company  
GOODING Gooding Tractor & Implement Co., South Main  
GRANGEVILLE John Hoene Implement, Inc., P. O. Box 47  
IDAHO FALLS Tractor Sales & Auto, Inc., 197 Park Ave.  
LEWISTON Reed's Hardware, 305 Main Street  
MOSCOW State Tractor & Supply Inc., 6th & Washington  
MOUNTAIN HOME Mountain Home Auto Parts  
TWIN FALLS Leslie Davis & Son

\* ARNOLD MACHINERY COMPANY, INC.  
433 West Second South St.  
Salt Lake City, Utah 84110

\* STAR MACHINERY COMPANY  
241 Lander Street  
Seattle, Washington 98134

### ILLINOIS

ALEDO Thede Company, 213-219 E. 7th St.  
ALTON Automotive Indus. Dist., Inc., 100 Oak St.  
ARTHUR Kauffman's Sales & Service  
BELLEVILLE H. Edwards Farm Equipment Company  
S. 8th Street, Route 13  
Fred Simon's Engine Repair  
BLOOMINGTON Bloomington Battery Service Co., 209 So. East St.  
CARMICLINTON Murphy Company, 805 E. Main St.  
CARTHAGE Smith Implement & Parts Co., 419 Main St.  
CASEY Hutton's Parts Service, 14 No. 7th Street  
CHAMPAIGN United Auto Supply, Inc., 101 E. Springfield  
CHICAGO 60623 \* INDUSTRIAL ENGINE & PARTS COMPANY  
1133 W. Pershing  
Air Cooled Engine Parts & Supply  
10504 South Halsted Street

Engines, Inc., 2847 N. Pulaski  
Midwest Handling Inc., 6900 W. 63rd Street  
Single Source Small Engine Co., 3945 Archer Avenue  
Bill's Mower & Eng. Repair, 128 Madison St.  
Lewis Johnson Garage, 310 No. Elizabeth St.  
Ruder Mower Service Sales & Rental, 1200 Belt Line  
Danville Auto Parts Co., 34 South Vermillion St.  
Bruce Implement Co., Niantic, Illinois  
Combs Service, 339 West Green Street  
National Auto Supply, 1100 Illinois Avenue  
H & D Motor Service, 111 E. Fayette Ave.  
Phillips Auto Parts, 370 Brook Street  
Stephens and Weaver Motors, East Highway 15  
Horton Bros. & Harder  
Oil Field Motor Service, Inc., Box 98  
Madison County Tractor & Equipment Company  
P.O. Box 277

CHRISMAN  
CLINTON  
COLLINSVILLE  
DANVILLE  
DECATUR

EFFINGHAM  
ELGIN  
FAIRFIELD  
GARRETT  
GRAYVILLE  
HAMEL

HARDIN Smith's Garage, West Main Street  
HARRISBURG Baker Machine & Supply Co., 626 North Main Street  
JACKSONVILLE Cully Implement Company, 222 W. Court St.  
JOLIET Zinser-Backstrom Co., 4 North Michigan St.  
KANKAKEE Electrical Equipment Co., 816 So. Schuyker Ave.  
KIRKWOOD Smith Implement Service, 423 Cherry St.  
LINCOLN Auto Electric Service, 110 No. McLean St.  
LYONS Keen Edge Company, 8615 Ogden Avenue  
MARION Cox Tire & Battery, 101-105 S. Court Street  
MATTOON Mattoon Motor Shop, 513 No. 14th Street  
MELROSE PARK Hillsman Equipment Co., 2000 North Hawthorne  
MENDOTA Kaiser Implement Co., Cherry Street  
MODESTO Fletcher's Garage  
MONTICELLO J. R. Heath & Son, Bridge Street  
MOUNT CARMEL Deck-Hill Battery Co., Third & Market Sts.  
MOUNT PROSPECT Charles B. Gray Sales  
MOUNT VERNON Ford National Auto Supply Co. Inc., 801 Casey St.  
NEWMAN Shephard Motor Company, 120 North Broadway  
OLNEY Big-G Farm Equipment Company, 116-120 W. Camp Ave.  
PALOS HILLS Portable Equipment Co., 11234 Southwest Highway  
PARIS M. Farnham Implement Company, 133 E. Wood St.  
PEORIA Power Equipment Co., 3610 Harmon Highway  
PONTIAC Wolf's Battery & Electric, 309 No. Oak St.  
QUINCY E. M. Chatten Implement Co., 2701 No. 24th Street  
ROCKFORD Lawn & Garden Supply, 2525 South Alpine  
ROCK ISLAND Lohse Lawn & Garden Center, 500 16th St.  
SANDWICH M. Werner & Sons, Inc., 523 E. Church Street  
SPRINGFIELD James Machinery Co., Inc., 130 W. Jefferson  
SPRING VALLEY Burl F. George Company, 118 Dakota St.  
STERLING Mylin's Agricultural Store, 221 E. 3rd St.  
TAYLORVILLE Ken's Engine & Mower, Route 48  
URBANA Champaign County Power Equipment Co.,  
1810 East University Ave.

\* ALLIED CONSTRUCTION EQUIPMENT COMPANY  
4015 Forest Park Avenue  
St. Louis, Missouri 63108

\* ENGINE POWER, INC.  
11811 W. Silver Spring Rd.  
Milwaukee, Wisconsin 53225

### INDIANA

AUBURN Shorty's Motor Service  
BLOOMINGTON Full-O-Pep Company, 424 S. College  
COLUMBUS Columbus Auto Supply, 2205 E. 25th Street  
CORYDON Kenneth H. Brown & Sons  
EVANSVILLE P. E. Phillips & Son  
FORT WAYNE McComb Ignition Corp., 1119 South Anthony Blvd.  
FRANKFORT Farmers Implement Co.  
GARY Lud's Motor Sales, 700 South Clark Road  
GOSHEN Elkhart Co. Farm Bureau Co-op. Ass'n  
GREENFIELDS Geo. P. Hinds Garage  
HAMMOND Carstensen's Service Company, 6950 Indianapolis Blvd.

INDIANAPOLIS 46207 \* EAGLE MACHINE CO., INC., 635 E. Market Street  
 KOKOMO Murray & Davis, 928 So. Union Street  
 LAFAYETTE Lafayette Auto Parts, 118 S. 4th Street  
 LIGONIER Reid's Lawnmower Shop, R.R. #1 U.S. Hwy. 6 West  
 MADISON Irwin Farmers' Store  
 MARION The Challenge Distributors  
 MICHIGAN CITY Michigan City Auto Parts, 1007 East Michigan Blvd.  
 MOUNT VERNON Stephan Implement Company  
 MUNCIE B & K Machine Co., 1215 S. Franklin St.  
 PENDLETON Wm. Ring & Sons.  
 PORTLAND Justin Schafer Company  
 PRINCETON Adams & Morrow, Inc.  
 RICHMOND Remsco, Inc., 1541 South 9th St.  
 ROCKVILLE Cummins-Flock Implement Co. Inc.  
 SCOTTSBURG Keenan's Radiator Service  
 SELLERSBURG A. Diefenbach & Sons  
 SHELBYVILLE D. & S Sales & Service  
 SOUTH BEND American Distributing Co.  
 TELL CITY Dauby Motor Company  
 TERRE HAUTE Decker Small Engines, Inc., 20 North 11th Street  
 TIPTON F. Ray Hull & Son  
 VALPARAISO Ketterman's Sales & Ser.  
 VINCENNES Wabash Parts Corp.  
 WINCHESTER Carpenter's Auto Supply

\* ATLAS MACHINE AND SUPPLY, INC.  
 1326-30 W. Jefferson  
 Louisville, Kentucky 40203

\* INDUSTRIAL ENGINE & PARTS COMPANY  
 2345 S. Pulaski Rd.  
 Chicago, Illinois 60623

\* CINCINNATI ENGINE & PARTS COMPANY, INC.,  
 2863 Stanton Ave.  
 Cincinnati, Ohio 45206

#### IOWA

ATLANTIC George's Auto Electric, 207-209 Walnut  
 BURLINGTON Friek Motor Company, 801 S. Main St.  
 CEDAR RAPIDS Happel & Sons, Inc.  
 CLINTON Nelson Auto Electric  
 COUNCIL BLUFFS Ballinger Automotive Service Company,  
 113-17 East Broadway Street  
 CRESTON Dieleman Auto Parts  
 DAVENPORT Emeis Electrical Service  
 DECORAH Decorah Implement Company  
 DES MOINES 50308 \* PORT HURON MACHINERY CO., 301 E. Court Avenue  
 Hein Mower & Saw Service, 2 East Army Post Road  
 David Mattson Company  
 R & R Welding Supply Co., 1700 2nd Avenue  
 DUBUQUE Farm & City Distributing Company  
 Power Lawn & Garden Equip. Co., 2551 J. F. Kennedy Rd.  
 Electric Motor Service Company  
 ESTHERVILLE Fort Dodge Machinery & Supply Co.  
 FORT DODGE Peterson Battery & Electric Co.  
 HARLAN Pyramid Services  
 IOWA CITY Harvey's Repair, 504 E. Lincoln Way  
 JEFFERSON Leon Short & Son  
 KEOKUK B & K Company, 112 East Church Street  
 MARSHALLTOWN Floyd & Leonard Auto Electric Co.  
 MASON CITY Peterson Implement, Inc.  
 MOUNT PLEASANT Lamp-Rehwaldt Company  
 MUSCATINE Skinner Sales & Service, 2110 1st Avenue W.  
 NEWTON Everett's Magneto & Carb. Service  
 OASKALOOSA Hurley's Parts & Service  
 OTTUMWA Pella Irrigation & Equipment Co., Box 158  
 PELLA Carlson Machine Works, 417-19 Wall Street  
 SIOUX CITY Ditch Witch Company of Iowa  
 SLATER Clough Motor Service  
 STORM LAKE Central Battery & Electric, 217-219 W. 5th  
 WATERLOO

WAUKON  
 WILMINGTON

Valiere Dundee Implement Company  
 AC & C, 1063 West Main Street

#### KANSAS

ARKANSAS CITY McCoy Engine Service  
 BELOIT Boettcher Supply Company, 120 West Court  
 CHANUTE Martin Tractor Company, Box 591  
 COFFEYVILLE Acme Foundry & Machine Company, 1502 Spruce St.  
 COLBY Dechert Implement Company, 135 North Franklin  
 DODGE CITY Scheuffler Supply Co. Inc., 319 West Trail  
 EMPORIA Serman Du-All Fixit, 331 Commercial  
 GARDEN CITY Kemper Auto Electric, 114 Stevens Avenue  
 GREAT BEND Scheuffler Supply Co., Inc., 808 Madison  
 HAYS S & W Supply Company, Inc.  
 HILL CITY S & W Supply Company, Inc., West Highway 24  
 HOXIE Patman Salvage Yard  
 HUTCHINSON Reno's Ace Hardware, Inc., 215 So. Main St.  
 KANSAS CITY AAA Engine & Electric, Inc., 700 Southwest Boulevard  
 LARNED Rath Equipment Co., Inc., 504 North Topeka, Box 310  
 LIBERAL Magneto & Electric Co., 522 North Kansas St.  
 MARYSVILLE Brauchi Bros., 704 Center St.  
 NORTON Norton Implement Company, 218 North First  
 PLAINVILLE Farm Implement & Supply Co.  
 RUSSELL Scheuffler Supply Co. Inc., 114 West Wisconsin  
 SCOTT CITY Withrow Repair, 402½ North College  
 TOPEKA Martin Tractor Co. Inc., 3320 Topeka Blvd., Box 1698  
 WICHITA 67202 \* HARLEY SALES COMPANY, 505 South Main Street  
 Folkers Supply, Inc., 801 West Second  
 WINFIELD Brad's Magneto Electric, 801-807 Manning

#### KENTUCKY

ASHLAND Barney Williams Company  
 BARDSTOWN Bardstown Auto Parts Company  
 BOWLING GREEN Motor Parts Depot  
 CAMPBELLSVILLE Kessler Implement Company  
 CORBIN Central Automotive Supply, 600 Main St.  
 CRESTWOOD Powell's Engine Sales & Service  
 ELIZABETHTOWN Hardin County Implement Company  
 GREENVILLE Wein Auto & Equipment Parts Co.  
 HENDERSON Henderson Farmers Supply Company  
 HOPKINSVILLE Coyce Mill Supply Company, 505 First St.  
 LEBANON Farmers Feed & Implement Co.  
 LEXINGTON 40501 \* WOMWELL AUTOMOTIVE PARTS CO., INC.,  
 240 Clark Street  
 LOUISVILLE 40203 \* ATLAS MACHINE & SUPPLY, INC.,  
 1326-30 W. Jefferson Street  
 Ky. Lawn Service  
 MADISONVILLE Baker Auto Electric Co.  
 MAYFIELD Eaton Dairies Farm Supply Co.  
 MIDDLESBORO Reliable Supply Company  
 MORGANFIELD S & K Auto Supply Co.  
 MURRAY McKeel Equipment Company  
 OWENSBORO E. A. Carter Supply Company, Inc., 511 Frederica St.  
 PADUCAH Rasche Cycle Company, 713 Kentucky Street  
 PIKEVILLE Campbell Oil Tool Company, Inc.  
 RUSSELLVILLE Russellville Tractor Co.  
 SCOTTSVILLE Yark & Massey  
 STURGIS S & K Auto Supply Co.

\* CINCINNATI ENGINE & PARTS COMPANY  
 2863 Stanton Ave.  
 Cincinnati, Ohio 45206

**LOUISIANA**

**ABBEVILLE** Dudley Landry Auto Supplies  
**ALEXANDRIA** United Electric and Magneto Service, 825 Tenth Street  
**BATON ROUGE** Fletcher Equipment & Supplies, 1605 Choctaw Road  
 Kerr Lawnmower Center, 2615 Airline Highway  
 Wm. F. Surgi Equipment Corp., Seigen Lane at Airline Highway  
**BASTROP** Kinnaid's Small Eng., 411 S. Pine  
**COUSHATTA** Coushatta Farm Implement Co.  
**EUNICE** Dovic Fruge Repair Shop  
**HAMMOND** Wendelken Machine Shop  
**HARVEY** Preventative Maintenance, 2816 Fourth Street  
 Westside Specialty Co., 3028 Fourth St.  
**KAPLAN** Gulfway Sporting Goods, P.O. Box 7  
 Vermillion Motor Service, 106 W. Fifth Street  
**LAFAYETTE** Southland Engine Co., 103 Arnold  
**LAKE CHARLES** Eagleson Lawnmower Shop, 903 Third Ave.  
**LAROSE** Welch Sales & Service, P.O. Box 218  
**LOCKPORT** Lockport Hardware Company  
**MINDEN** Martin's Cycle & Lawnmower Center  
**MONROE** Howard Griffin, 712 S. Grand Street  
**MORGAN CITY** Power Products Service, Inc., Highway 90 East  
**NATCHITOCHE** C. E. Collins & Sons, P.O. Box 519  
**NEW IBERIA** Voorhies Machine Supply Company  
**NEW ORLEANS** 70150 \* WM. F. SURGI EQUIPMENT CORP.,  
 1149 Tchoupitoulas Street  
**OPELOUSAS** J. L. Hebert Engine Sales & Service, 111 South Liberty St.  
**RAYNE** Haure Machine Shop  
**RUSTON** Montgomery Feed & Seed  
**SHREVEPORT** Construction Machinery Corp.  
 Continental Engine Sales & Service, 2136 E. Texas St.  
 United Power Co., P.O. Box 1383  
**VENICE** Ellzey Marine Supply  
**VIDALIA** Reagan Equipment Company, P.O. Box 914  
**WINNSBORO** McLemore Wholesale Grocery

**MAINE**

**AUGUSTA** Parker Danner Company, Riverside Drive  
**BANGOR** H. E. Peabody Co., 100 Thatcher St.  
**HOULTON** James S. Peabody Company, Bangor Street  
**PORTLAND** Chadwick-BaRoss, Incorporated, 803 Forest Avenue

\* DIESEL ENGINE SALES & ENGINEERING CORP.  
 Fish Pier Road  
 Boston, Massachusetts 02210

**MARYLAND**

**ANNAPOLIS** Baldwin Service Center, Inc., Rt. 450 at Rt. 178  
**BALTIMORE (18)** Curtis Enging & Equipment  
 General Supply & Equipment Co. Inc., 530 E. 25th Street  
 Gustins Baltimore Toro, 2205 E. Joppa Road  
 Hart Equipment Company, 8110 Pulaski Highway  
 John C. Louis Co. Inc., 1805 Cherry Hill Road  
**BELTSVILLE** John S. MacBryde Co., 10511 Tucker St.  
**BLADENSBURG** Martin & Otterback, Inc., 4814 Upshur  
**CAPITOL HEIGHTS** Zebra Motor & Marine, Inc., 6113 Central Ave.  
**CHASE** Chase Lawn Mower Service  
**CHESTERTOWN** Silver Hill Shop  
**CHURCHVILLE** Walter G. Coale, Inc.  
**FREDERICK** Baker's  
**FUNKSTOWN (Hagerstown)** Lutherville Supply & Equipment Co. Inc.  
 108 East Baltimore Avenue  
**GAITHERSBURG** Norman & Staiger, Inc., P.O. Box 66  
**HUGHESVILLE** South End Garage  
**KENILWORTH** Tri-State Auto Parts, 2001 Kenilworth Avenue N.E.  
**MILLINGTON** Julian E. Leager, Main Street  
**PASADENA** Jack's Repair Service, Inc., 2460 Mountain Road

**POCOMOKE CITY** Pocomoke Foundry & Machine Works  
**SALISBURY** MacMillan Bros.  
**SUITLAND** Cox Oil Company, 4815 Suitland Road  
**WALDORF** Maryland Tobacco Growers

\* POTTER EQUIPMENT COMPANY  
 6200 N. Capitol Street, N.W.  
 Washington, D. C. 20011

**MASSACHUSETTS**

**BOSTON 02210** \* DIESEL ENGINE SALES & ENGINEERING CORP.  
 Fish Pier Road  
**BROCKTON** Sargent Supply Corporation, Meadowbrook Road  
**DANVERS** Clifford T. Whittaker Company, 3 Hobart Street  
**HYDE PARK** Parker Sales Company, Factory Street  
**PITTSFIELD** Smith Auto Electric Service, Inc., 1328 East Street  
**SPRINGFIELD** Springfield Auto Electric Service, Inc., 50 Carew Street  
**WORCESTER** Worcester General Repair Shop, 43 Chandler Street

**MICHIGAN**

**ANN ARBOR** Auto Parts Company  
**BATTLE CREEK** Battle Creek Motor Parts, Inc., 220 South Washington  
**BAY CITY** O. J. Herman  
**CHARLOTTE** Fowler Sales Company  
**COLDWATER** Treat Auto Parts  
**CRYSTAL FALLS** H. Malkin & Sons, Inc., 11 Superior Ave.  
**DETROIT 48227** \* R. G. MOELLER CO., 14415 Meyers Road  
 Arthurs Auto Parts, 837 South Dix  
**ESCANABA** Escanaba Machine Co., 1704 Ludington Street  
**FARMINGTON** Mays Nursery, 29900 Ten Mile Rd.  
**FLINT** Matthews Sales & Service  
**GRAND RAPIDS 49509** \* R. G. MOELLER CO., 2564 Chicago Dr., S.W.  
**HARTFORD** Walkers Service  
**HOUGHTON** Vivian Equipment Corp., U.S. Hwy. 41  
**IRON RIVER** Stan's Farmers Mart  
**JACKSON** Superior Sales & Service, 114 North State  
**KALAMAZOO** Kalamazoo Impl. Co., 3617 W. U.S. 12  
**LANSING** J. B. Sales & Service, 5438 South Cedar Street  
**MARQUETTE** Carroll Motor Supply, 211 South 5th Street  
**MENOMINEE** Automotive Products Co., 520 So. 1st Street  
**MILBREM** L. Gelder & Sons  
**MT. CLEMENS** Power Equipment Distributors on Gratiot Avenue  
**MT. PLEASANT** Ben Traines & Sons, Inc.  
**MUSKEGON** H. G. Davis & Son  
 Great Lakes Equipment Corp., 1461 Evanston Avenue

**NILES** Klute Electric  
**PONTIAC** King Brothers, 2391 Pontiac Road  
**PORT HURON** Belt Line Auto Electric, 13203 Lapeer Road  
**SAGINAW** Superior Motor Supply, 721 S. Franklin  
**SCOTTVILLE** Howard Thiel

**ST. CLAIR SHORES** D'Haem's Tool Rental  
**SAULT STE. MARIE** Electric Equipment Company  
**TRAVERSE CITY** Map-Pul, 324 W. 13th Street  
**TRENTON** Dix Equipment Co., Dix Toledo Highway

(Northern)  
 \* ENGINE POWER, INC.  
 11811 W. Silver Spring Rd.  
 Milwaukee, Wisconsin 53218

**MINNESOTA**

**ADA** Munter Motor Service, 403 W. Thorpe Avenue  
**ALEXANDRIA** A & C Engine Service, 612 Irving Street  
**BENSON** Lorenz Machine and Supply, 205 - 14th St. North  
**CHASKA** Malinau Implement Company  
**CROOKSTON** Hegland Motors, 811 South Main Street  
**DULUTH** Hanson's Genuine Parts, 335 S. First Ave. East  
**EAST GRAND FORKS** Johnson Iron & Machine Co., 1201 DeMers Ave.

FERGUS FALLS Lykken, Inc., P.O. Box 442  
HIBBING Horn Electric Service, 1923 - 2nd Avenue, East  
HUTCHINSON C. H. Stocking Company, 218 Main St.  
MADISON Brehmer Motor Supply, Inc., 106 - 6th Avenue  
MINNEAPOLIS-ST. PAUL  
R. L. Gould & Company, 500 Jackson Street (St. Paul)  
Industrial & Truck Parts, Inc., 4135 Hiawatha Avenue  
Minneapolis Equipment Company  
520 Second Street S. E.  
Engine Parts Supply, Inc.  
1221-9 Harmon Place  
Zeco Company, 9033 Lyndale Ave. So.  
Campbell Implement Company, 311 So. First St.  
Koeht Sales & Service, 1012 Atlantic Ave.  
General Trading Company, 400 N. Main Street  
Phil's Auto Electric, 121 W. Main Street  
Schultz Impl.  
Preston Iron Works, Mill St.  
Behrens Auto Supply Co., 211 Main St.  
Falls Implement Company, 515 W. Bridge Street  
Alexander Auto Electric Co., 410 - 6th Avenue  
Earls Tree Service, 218 Mill Street  
Ditch Witch of Minnesota, Box 234  
Vos Mower Service, 1900 7th St. No.  
Northern Engine & Supply, Box 111  
Johnson Implement Co., 112 Tenth Ave. S.E.  
John Peterson Implement Company, Box 311  
Auto Electric Service Co., Cor. 2nd & Johnson  
Western Implement Company, 508 Oxford St.

MONTEVIDEO  
MORRIS  
NEW ULM  
OWATONNA  
PLAINVIEW  
PRESTON  
RED WING  
REDWOOD FALLS  
ROCHESTER  
RUSHFORD  
SHAKOPEE  
ST. CLOUD  
VIRGINIA  
WASECA  
WILLMAR  
WINONA  
WORTHINGTON

\* ENGINE POWER, INC.

6336 Lakeland Avenue, North  
Minneapolis, Minnesota 55429

MISSISSIPPI

ABERDEEN Brown Auto Parts  
BROOKHAVEN B & O Mill-Industrial & Oil Field Supply,  
Highway 51 North  
CLARKSDALE Farm Service Co.  
CLEVELAND George's Lawn Mower Service  
COLUMBUS Bidly Saw Works  
GREENVILLE Thompson Battery & Electric Company  
GREENWOOD Johnson Implement Company  
GRENADA J. H. Bidly & Sons  
GULFPORT Gulfport Battery  
HATTIESBURG Carburetor & Ignition Company, 109 Green Street  
Taylor Machinery Corp., Broadway at 63rd St.  
Bellipanni Brothers  
INDIANOLA Taylor Machinery Corp., U. S. Hwy. 80 at S. Gallatin  
JACKSON Whit's, 1313-15 S. Gallatin St.  
LAMBERT Lambert Auto Parts  
LAUREL Devine Sales & Service, 329 N. Maple Street  
LOUISVILLE D & T Parts Service  
McCOMB Guyton's Auto Electric, 125 S. Broadway  
MERIDIAN Kelley-Williams Co.  
NATCHEZ OK Sales Company, Bypass Road  
PASCAGOULA Bell Auto Parts, 735 Telephone Rd.  
PICAYUNE Polk's Firestone Dealer Store, 125 W. Canal  
QUITMAN Reliable Welding & Radiator Company  
TUNICA Planters Tractor & Implement Company  
TUPELO Tupelo Farm Equipment Company  
VICKSBURG Melsheimer's Garage, P. O. Box 739  
WEST POINT Cliett Auto Parts Company  
YAZOO CITY Motor Parts Co.

\* WM. F. SURGI EQUIPMENT COMPANY  
1149 Tchoupitoulas St.  
New Orleans, Louisiana 70150

\* RCH DISTRIBUTORS, INC.  
92 W. Carolina Avenue  
P. O. Box 2828,  
Memphis, Tennessee 38102

MISSOURI

AFFTON Erb Equipment Company, Inc., 11714 Gravois  
CANTON Canton Implement Company  
CAPE GIRARDEAU Schneider Equipment Company  
Highway 61 & Bloomfield Road  
COLUMBIA Blackmore's Automotive Service, Inc.,  
Highway 40 & Garth  
FLORISSANT Brinker Tractor Sales, Inc., 2505 N. Highway 140  
P. O. Box 538  
HAMILTON Hamilton Supply Company  
INDEPENDENCE Al's Farm & Garden Equipment, 1622 West 24 Highway  
JEFFERSON CITY Harry Blackwell, Inc., 420 Jefferson Street  
JOPLIN Motor Electric Service, 622 Wall Street  
KANSAS CITY 64105 \* A. A. KLUGHARTT MACHINERY COMPANY  
1205 Woodswether Road

A & D Hatchery & Supply, 4807 North Brighton  
Automotive Equipment Service, 3117 Holmes Street  
Whitlock Coal & Implement Company  
Lewis G. Moore Tractor & Implement Co.  
T & H Auto Supply  
Prost Implement Company  
Long Farm Supply Company  
Vernon's Implement Co.  
Stuart Machine Company  
Farm Supply Company

MARSHALL  
MARYVILLE  
MEXICO  
PERRYVILLE  
PLATTSBURG  
POPLAR BLUFF  
RICHMOND  
ST. JOSEPH

ST. LOUIS 63108 \* ALLIED CONSTRUCTION EQUIPMENT COMPANY  
4015 Forest Park Avenue

Fillmore Auto Electric Service, Inc., 414 Fillmore Street  
(31) Outdoor Equipment Co. Inc., 12012 Manchester Rd.  
George F. Smith Company, 755 South Lindberg  
Wollgast Supply Company, 2783 Dunn Road  
Gibson Implement Company  
Hay's Saw & Mower Center, 115 South Handy  
Cave Carburetor Exchange, 307 W. Pershing  
Ozark Trencher Sales, Inc., R.R. #2 - Springfield Road  
Hartbauer Auto Parts Co.  
Ozark Diesel, North Highway 63 Box 395

SEDALIA  
SIKESTON  
SPRINGFIELD  
SULLIVAN  
WASHINGTON  
WEST PLAINS

MONTANA

BILLINGS 59101 \* MIDLAND IMPLEMENT CO., INC., 402 Daniels  
Hustad Implement Co.  
Gallatin Equipment  
Automotive Supply Company  
Tiber Tractor Company  
H & H Implement Co.  
Farmer Supply Co-op  
Service Supply  
Southmont Tractor Co.  
Wallin Mercantile Company  
Green Line Equipment  
Milne Implement Company  
Farm & Ranch Equipment  
Farm & Ranch Equipment Co.  
Steffeck Equipment Company  
Stedje Brothers  
Horning Implement Co.  
Strong & Bradley  
Malta Auto Company  
Miles & Ulmer  
Bedford Implement Company  
Halse Motors  
Sidney Carburetor & Electric Co.  
Moe Motor Co.

BOZEMAN  
BUTTE  
CHESTER  
CHOTEAU  
CONRAD  
CUT BANK  
DILLON  
FORSYTH  
FT. BENTON  
GLENDALE  
GREAT FALLS  
HAYRE  
HELENA  
KALISPELL  
LEWISTOWN  
LIVINGSTON  
MALTA  
MILES CITY  
MISSOULA  
SHERIDAN  
SIDNEY  
WOLF POINT

## NEBRASKA

BEATRICE Sprague Electric Service  
 COLUMBUS Automotive Sales and Service  
 CRAWFORD Bruer and Son Company  
 FREMONT Auto Electric  
 GORDON Modern Equipment  
 GOTHENBURG Lepp & Osterloh  
 GRAND ISLAND Reitan's, Inc.  
 GRANT Andrews & Son  
 HASTINGS Sherman Service Center  
 HOLDREGE Bierman Service  
 IMPERIAL Prior's  
 KIMBALL Rohrbach Farm Equipment  
 LEXINGTON Ray's Repair Shop  
 LINCOLN \* PORT HURON MACHINERY & SUPPLY COMPANY  
 801-813 'Q' Street  
 McCOOK Kleins Motor & Electric  
 NORFOLK Harry's Motor  
 NORTH PLATTE Frank's Farm Equipment  
 OMAHA F. W. Pruitt Company, 4524 Leavenworth  
 PIERCE Kolterman Service Company  
 SCOTTSBLUFF Keeley Auto Electric Inc.  
 SIDNEY Larson Machinery Co.  
 VALENTINE Lutter Implement Company  
 WEST POINT Zobel Farm Store  
 YORK Nabers Automotive

## NEVADA

ELKO Bellinger Motors Sales & Service, 608 Commercial St.  
 FALLON I. H. Kent Company  
 LAS VEGAS Blystone Equipment Co., 3184 Fremont  
 LOVELOCK Carpenter's, Inc., P.O. Box 500  
 RENO Air Service Company, 3350 Kietzke Lane  
 WINNEMUCCA Etchart Machinery, Box 168

\* E. E. RICHTER & SON, INC.  
 6598 Hollis Street  
 Emeryville, California 94608

\* LANCO ENGINE SERVICES, INC.  
 12915 Weber Way  
 Hawthorne (Los Angeles), California 90252

\* ARNOLD MACHINERY COMPANY, INC.  
 433 West Second South Street  
 Salt Lake City, Utah 84110

## NEW HAMPSHIRE

CONCORD New Hampshire Explosives & Machinery Company  
 323 South Main Street  
 MANCHESTER Dunbar Farm Equipment Company,  
 Daniel Webster Highway & West Hole Ave.: Hooksett  
 WALPOLE R. N. Johnson, Inc., Bellows Falls Road

\* DIESEL ENGINE SALES & ENGINEERING CORP.  
 Fish Pier Road  
 Boston, Massachusetts 02210

## NEW JERSEY

BELLMAWR Lawn Mower Parts, Inc., 717 Creek Rd.  
 BLAWENBURG J. Percy Van Zandt  
 BRIDGETON Serata Sons Co., 53<sup>rd</sup> So. Pearl Street  
 FLEMINGTON Flemington Farm Equipment Company  
 HIGHLAND PARK Kish Bros., 179 Woodbridge Ave.  
 HIGHTSTOWN Hights Farm Equipment  
 HILLSIDE Equipco, 620 Ramsey Ave.

JERSEY CITY Wishbow Bros. Inc., 696 Communipaw Avenue  
 LINWOOD Seaview Service & Supply Co., 1904 Shore Rd.  
 MORRISTOWN American Auto Parts, 8 Mt. Kemble Avenue  
 NEWARK Bell Magneto Service, 191 Second Street  
 RED BANK J. H. Kelly Company, 157 Broad Street  
 RIDGEWOOD Ace Motor Company, 33 Douglas Place  
 TRENTON Bill Blackwell's Garden Supplies, 1962 Olden Street  
 (8) Equipco-Trenton, Inc., 303 Whitehead Road  
 VINELAND Pagano Bros. Inc., 416 Wood Street  
 WESTFIELD Storr Tractor Co., 469 South Ave., East  
 WOODSTOWN Owen Supply Company, East Ave. & Broad St.

\* JOHN REINER & COMPANY  
 94-15 150th Street  
 Jamaica, New York 11435

\* JOS. L. PINTO  
 5918 Baltimore Avenue  
 Philadelphia, Pennsylvania 19143

## NEW MEXICO

ALBUQUERQUE 87101 \* CENTRAL AUTO ELECTRIC CO.  
 808 Second Street, N. W.  
 Carson & Ellis, Inc., 2401 First St.  
 ARTESIA Motor Machine Company  
 CARLSBAD Hall Machinery  
 CLOVIS Tucker Equipment Co., 2119 W. 7th  
 FARMINGTON Justis Supply Company  
 GALLUP Tony Ray, 210 West Maloney  
 HOBBS Engine & Industrial, 1010 Broadway  
 LOVINGTON Magneto Ignition Company  
 PORTALES White Equipment Co., P. O. Box 177  
 RATON Mack & Sons Marine, 695 Collier  
 ROSWELL Savage Brothers Electric  
 SANTA FE Santa Fe Auto Electric

## NEW YORK

ADAMS CENTER The Talcott Falls Tractor Sales, Inc. Route 11  
 ALBANY Able Tractor & Equip. Co., Inc., 72-74 Everett Road  
 AUBURN Wayne Auto Electric, 26 E. Genessee St.  
 BATAVIA Devener Automotive Supply, 238 West Main Street  
 BINGHAMTON Norton's Service, Inc., 359 Court Street  
 BOLIVAR Bolivar Magneto Co., 65 Wellsville St.  
 BUFFALO Fox Equipment Co., 2018 Seneca Street  
 CANANDAIGUA Donald Howard, Hopewell Center Road  
 CANTON Canton Auto Parts  
 EAST AVON Davin Implement Co., Inc.  
 ELMIRA Ritter's Automotive Electric Service, 307 Railroad Ave.  
 ELMSFORD Stillwell Equipment Corp., 233 Tarrytown Road  
 FREDONIA P. J. Zbrasky & Son, East Main Road  
 GLOVERSVILLE McCue's Auto Parts, Inc., 70 North St.  
 GOSHEN Gor-Dun's, Inc., R.D. 2, Finnegan's Corners  
 GOUVERNEUR Gouverneur Auto Parts & Supply Co., 16 Park Street  
 HUDSON Pitcher Accessories, Inc., 732 Columbia Street  
 HUNTINGTON STATION Island Auto Parts, 995 New York Ave.  
 JAMESTOWN Jamestown Unit Parts Co., Inc., 208 W. Fourth Street  
 KINGSTON Ulster Foundry & Machine Corp., 20 St. James Street  
 LAKE GEORGE Smith Equipment, Rte. #9 South  
 LIBERTY Charles E. Lennon & Son, Revonah Park  
 LONG ISLAND Burns & Horton, 107 Jericho Turnpike, Floral Park  
 William Kroemer & Sons, 145 W. John St., Hicksville  
 MARLBORO Ralph C. Herman Company, Route 9W  
 MASSAPEQUA PARK (LONG ISLAND) George Smith & Sons, Inc.,  
 4736 Sunrise Highway  
 MASSENA V. S. Jerry & Sons Corp., East Orvis St. Road  
 MIDDLEPORT Clayton & Dickenson, R. D. Route 104  
 NEW YORK CITY 11435 \* JOHN REINER & COMPANY  
 94-15 150th Street, Jamaica

NORTH WHITE PLAINS Austin & Barrett, 868 North B'dway  
 OLEAN Bolivar Magneto Co., East State Road  
 ONEONTA Oneonta Tire & Auto Parts, 116 Main St.  
 PLATTSBURG Vincent S. Jerry & Sons, Inc., 5 Macdonough Street  
 POUGHKEEPSIE Waelde the Welder, 6 North Clinton Street  
 RENSSELAER Van's Equipment Sales, Inc., Route 9 & 20  
 RIVERHEAD Tryac Truck & Equip. Company, Pulaski Street  
 ROCHESTER Keystone Builders & Supply Company, 85 Palm Street  
 SCOTIA Scotia Machine & Tool Co., Inc., 8 John St.  
 STATEN ISLAND Forest Equipment Co., 1319 Forest Avenue  
 SYRACUSE 13208 \* JOHN REINER & CO., INC., 946 Spencer Street  
 UTICA Stiefvater Electric Co., 320 Lafayette Street  
 WASHINGTON MILLS Halligan & Roberts, Route 8  
 WILLIAMSON Ralph A. Verbridge, Route #104  
 WOLCOTT Wolcott Implement Co., 79 Lake Avenue

**NORTH CAROLINA**

AHOSKIE L. S. Jernigan & Son, Company  
 ALBEMARLE Ivey Sales Co. Inc., 138 S. Depot St.  
 ASHEVILLE R. T. Clapp Company, Inc., 201 Cox Avenue  
 BEAUFORT Barbour Marine Supply, Front Street  
 CHARLOTTE Contractors Service & Rental, Inc.,  
 317 West Worthington Avenue  
 Hertz Equip. Rental Corp., 1415 W. Independence Blvd.  
 H. B. Owsley & Sons Co.  
 Rent-Equip Inc., 3521 Asbury Ave., P.O. Box 1872  
 DURHAM Colvard Farm Equipment Co., 748 E. Greer St.  
 ENFIELD Enfield Tractor Company, 147 E. Whitfield Street  
 FARMVILLE Farmville Implement Company  
 FAYETTEVILLE Eastern Turf Equipment, Inc., 148 Maxwell Street  
 GASTONIA Southern Supply Company, 258 East Main Street  
 GOLDSBORO Johnson-Sherman Co.  
 GREENSBORO 27402 \* KING-McIVER SALES, INC., So. Elm St. Extension  
 GREENVILLE R. F. McLawhon & Sons Co.  
 HENDERSON Farm Tractor & Equipment Co., 231 E. Montgomery St.  
 HICKORY The Flowers Co.  
 KINSTON Johnson-Sherman Co.  
 LAURINBURG John Blue Company  
 LEXINGTON Leonard Machine Company, 100 West Fifth St.  
 LUMBERTON Currie Chain Saw Company, 1311 West Fifth Street  
 Johnson Cotton Company  
 MOUNT AIRY Surry Truck & Tractor Co., P.O. Box 287  
 NEW BERN Southeast Equipment Co.  
 RALEIGH S. M. Crocker & Sons  
 ROANOKE RAPIDS Harding & Grizzard, Inc., 300 Roanoke Avenue  
 ROCKY MOUNT Browning Auto Parts, 205 E. Thomas Street  
 SANFORD H & H Auto Parts Co., 215 Carthage St., P. O. Box 758  
 SHELBY Lutz-Yelton Tractor & Truck Co., 400 N. Lafayette St.  
 SMITHFIELD Collins Saw & Pulpwood Co., 808 Massey Street  
 WASHINGTON W. C. Mallison & Sons, Company  
 WHITEVILLE Elliott Implement Co., Highway 701 South  
 WILLIAMSTON Reddick Equipment Co., Highway 64 West  
 WILMINGTON Hundley Equipment Co.  
 Rental Tool Company, 4316 Market St.  
 WINSTON SALEM Hertz Equip. Rental Corp., 1422 S. Main Street

**NORTH DAKOTA**

BACKOOL Holen Repair Shop  
 BEACH Dakota Farm Equipment  
 BEULAH Unruh Garage  
 BISMARCK Bismarck Farm Equipment  
 BOTTINEAU Olson Equipment Company  
 BOWMAN Pond's Implement  
 COOPERSTOWN Farmers Oil Co.  
 CARRINGTON Frank Johnson Implement Inc.  
 CROSBY Sortland Implement  
 DEVILS LAKE M. & I. Electric Company

DICKINSON Decker Implement  
 DUNN CENTER Dunn Center Motor Co.  
 FARGO 58102 \* NORTHERN ENGINE & SUPPLY INC.  
 2710 Third Avenue North  
 P.O. Box 1532  
 Rent or Buy  
 FESSENDEN Wells County Implement  
 GRAFTON Grafton Auto & Electric  
 GRAND FORKS Rent or Buy  
 HARVEY Nelson Auto & Implement  
 HETTINGER Hettinger Farm Equipment  
 HILLSBORO Rent or Buy  
 JAMESTOWN A & D Diesel  
 LANGDON Ray Lebrun  
 LINTON Schotz Auto & Implement  
 LISBON Sturdevant's Auto Electric  
 MINOT Motor Service Company  
 MINTO Super Service Garage  
 NAPOLEON Sievert Implement & Auto  
 NEW ENGLAND Western Implement  
 NEW ROCKFORD Page and Anderson, Inc.  
 NORTHWOOD Ray Anderson Implement  
 OAKES Tedin Implement  
 ROLLA Welander & Son Implement  
 RUGBY Dan's Aviation  
 STANLEY Nelson Implement Company  
 VALLEY CITY Farmotor, Inc.  
 WAHPETON Sturdevant's Auto Electric  
 WASHBURN Wicklander Machine  
 WILLISTON Electric Magneto Service Co.

**OHIO**

AKRON Gauer Service & Supply, 676 Waterloo  
 Hopkins & Kipp, 348-352 W. Bowery St.  
 Friends Auto Electric  
 ASHTABULA Dunson Supply Company, 238 North Columbus Street  
 BELLEFONTAINE Cadiz Mfg. Company, Buffalo St.  
 CADIZ Gibson Supply Company, 2400 West Wheeling Ave.  
 CAMBRIDGE Arch-Linder Tractor & Equip. Co.,  
 3709 Columbus Rd., N.E.  
 CANTON  
 CECIL Harts Auto Parts  
 CINCINNATI 45206 \* CINCINNATI ENGINE & PARTS CO., INC.,  
 2863 Stanton Avenue  
 Farm Implements, Inc., 9770 Montgomery Road  
 CLEVELAND Brooklyn Tractor & Mower Co., 247 Brookpark Rd.  
 Industrial Engine Parts, Inc., 1437 East 32nd St.  
 COLUMBUS 43212 \* ALLIED FARM EQUIPMENT, INC.  
 McCune-Frick Division  
 1066 Kinnear Road  
 Lorenz Equipment Company, 547 West Rich Street  
 Machinery & Tool Rentals, 511 West Town St.  
 Ohio Auto Parts Company, 4th & Spring St.  
 Flack Equipment Company, 1240 McCook Ave.  
 Ludlow Ignition  
 DAYTON Miller Implement Company, 50 Ross Street  
 Barber & Conley  
 DELAWARE Warner Parts Company, 218-20 No. Front St.  
 EATON Rodefild & Co., 701 Walnut Street  
 FREMONT Savage Auto Supply Co., 630 Maple Ave.  
 GREENVILLE Huron Auto Parts Co., 808 Williams St.  
 HAMILTON McCurley Implement Company  
 HURON Lima Flack Equipment  
 LEBANON Oaklief Saw & Mower Service, 1074 Lucas Rd.  
 LIMA Marietta Ignition, Inc., 181 Front St.  
 MANSFIELD Dutt Implement Co., 965 Pole Lane Road  
 MARIETTA Mentor Elevator Company, 927 Center Street  
 MENTOR Schrock's, Inc., 801 Yankee Rd.  
 MIDDLETOWN Bunkerhill Engine & Farm Supplies, Rte #5  
 MILLERSBURG Wilkin Farm Store, Inc., 177 National Drive  
 NEWARK Worcester Sales & Service  
 NORTH RIDGEVILLE Staker Sales & Service, 1424 9th St.  
 PORTSMOUTH  
 ST. CLAIRSVILLE Efav Electric & Radiator Co., Inc., 303 South Market St.

SPRINGFIELD S.A.F. Implement Co., 1837 Columbus Ave.  
 STEUBENVILLE Tobin Auto Electric, 807 Market Street  
 TIFFIN Earl J. Crane, Inc.  
 TOLEDO Toledo Auto Electric, 35 - 17th Street  
 TROY Snyder & McDonald Garage, 904 So. Union  
 WALBRIDGE V. E. Peterson Company, Box 183 R.D.  
 WARREN Automotive Incorporated  
 WILMINGTON Compton Metal Products  
 WOOSTER Wooster Storage Battery, 558 Liberty Street  
 YOUNGSTOWN 44515 \* ALLIED FARM EQUIPMENT, INC.  
 McCune-Frick Division  
 3721 Mahoning Avenue  
 Electric Equipment Company, 22 W. Myrtle Avenue  
 The Industrial Engine Service Co., 1001 N. Meridian Rd.  
 Goss Supply Company, 628 Marietta Street

\* EAGLE MACHINE COMPANY, INC.  
 635 E. Market Street  
 Indianapolis, Indiana 46207

### OKLAHOMA

ADA Ada Auto Supply, 301 East 12th Street  
 BARTLESVILLE Keystone Supply Company, 543 South Rogers  
 BLACKWELL Crawford Welding & Magneto Service, 122 East Frisco  
 BRISTOW Standard Auto Parts Co., 205 East Seventh  
 CHANDLER Stinchcomb Implement Co., 906 West 15th Street  
 CHICKASHA Sheppard's Supply, 111 So. 6th St.  
 DUNCAN Motor Parts & Service, 209 North 7th Street  
 DURANT Williams Implement Company, 115 South 2nd Street  
 EAKLY King's Irrigation Sales & Service, Route 3  
 ENID Brueggemann Supply Co., 412 North Independence  
 HEALDTON Lewis Magneto & Supply  
 HUGO Hugo Implement Company, 1104 West Jackson  
 LAWTON C & E Supply Company, 207 "D" Avenue  
 MUSKOGEE Victory Motors, 605 South Cherokee  
 NOWATA Keystone Supply Company  
 OKLAHOMA CITY City Auto Parts & Machine, 31 Northeast 10th Street  
 Industrial Engine Parts & Machine, Inc.  
 1016 Northwest First St.  
 PAULS VALLEY James Supply Company, Box 394 (410 South Chickasha)  
 PERRY Wurtz & Wurtz Motor Company, 624 Elm Street  
 PONCA CITY Edwards Equipment Co., 401 South First Street  
 SEMINOLE Sid's Magneto Shop, 106 North Fourth Street  
 SHAWNEE Abernathy Engine Works, 708 East Main St.  
 TULSA \* HARLEY SALES COMPANY, P.O. Box 1259  
 WALTER Copeland Equipment Company

### OREGON

ALBANY Herrold and Jensen Implement Co., Box 321  
 BEND Moty & Van Dyke Inc.  
 BURNS Oards Service & Garage  
 CANBY Canby Motor Parts, Box 877  
 COOS BAY Coos Bay Marina, Box 1011  
 CORYALLIS Benton Tractor Company, 1917 South 3rd St.  
 EUGENE J & J Power Equipment, 1305 W. Sixth  
 GRANTS PASS Stewarts Small Engine Service, 509 S. W. G. Street  
 GRESHAM Vic's Motors, 1821 E. Powell  
 HAINES Haines Commercial Equipment Co.  
 HARRISBURG Moody Hardware Company  
 HILLSBORO Hillsboro Impl. Co., 31675 Tualatin Valley Hy.  
 HOOD RIVER Central Sales Inc., Route 4  
 KLAMATH FALLS Moty & Van Dyke, Inc., Box #801  
 LAKEVIEW Albertson Tractor Co., Box 828  
 LEBANON Moty & Van Dyke Inc.  
 MC MINNVILLE Cascade Tractor & Implement Co., Box 146  
 MEDFORD Cascade Electric Motor Service, 335 East McAndrews Rd.  
 NYSSA B & M Equipment Co.  
 PENDLETON Oregon Motor Service, P.O. Box 258

PORTLAND 97210 \* INDEPENDENT DISTRIBUTORS, 2355 N.W. Quimby St.  
 A.S.E. Supply Company, 431 N.W. 9th  
 Hamilton Engine Sales, 2580 N. W. Upshur  
 King Ford Tractor Company, 2007 North Williams  
 RICKREALL Rickreall Farm Supply  
 REDMOND Kelsey's Electric, P. O. Box 1442  
 ROSEBURG Le Bleau Motors, Inc., 319 S.E. Jackson  
 SALEM E. H. Burrell Company  
 SILVERTON Cascade Farm Machinery, 709 McClaine St.  
 THE DALLES Greenline, Inc., Box 438, East Frontage Road  
 WOODBURN Witham Garden Center, 894 N. Pacific Hiway

\* ARNOLD MACHINERY CO., INC.  
 433 West 2nd South  
 Salt Lake City, Utah 84110

### PENNSYLVANIA

BEAVER FALLS Reliable Motor Parts Co., 1700 Seventh Ave.  
 BELLEVILLE Samuel Crissman Service Station  
 BETHLEHEM Eastern Chain Saw & Supply Co.,  
 R. D. 2, Nazareth Pike  
 BIGLERVILLE Adams County Fruit Packing Company  
 L. W. and M. S. Kleinfelter  
 BRADFORD Tool "n" Toy Service Center  
 BRYN MAWR Aviation Automotive Parts, Inc., 899 Penn St.  
 BUTLER Hoffman Auto Parts, 237 West Jefferson Street  
 CHAMBERSBURG Paul Byers  
 CLARION Furlong Service  
 CLEARFIELD Gray Storage Battery Co., 212 E. Locust Street  
 CONNELLSVILLE Back Creek Lumber Company  
 DOYLESTOWN Doylestown Agricultural Co.  
 DRUMS Highway Equipment & Supply Co.,  
 U. S. Route 309, P. O. Box 127  
 EAST LANSDOWNE 19050 \* JOS. L. PINTO, INC.  
 719 E. Baltimore Pike  
 EASTON Easton Electrical Devices  
 EPHRATA (Lancaster County) \* HAMILTON EQUIPMENT, P. O. Box 478  
 ERIE West Ridge Motors, 2518 Hampton Road  
 GREENSBURG Auto Electric & Brake Service, 107 Urania Ave.  
 HANOVER W. L. Sterner, 516 Frederick Street  
 HARRISBURG Highway Equipment Company, 5100 Paxton Street  
 JOHNSTOWN Battery & Electric Corporation, 700 Franklin Street  
 KINGSTON Standard Equipment Company  
 LANCASTER Bart's Repair & Service, 1952 Landis Valley Rd.  
 L. H. Brubaker, R. D. 4  
 LEBANON Krall Battery & Ignition Company, 5th & Cumberland St.  
 Elmer Plasterer, Inc., 26 Evergreen Road  
 THOMAS Auto Electric, 227 Valley Street  
 LEWISTOWN W. R. Wynkoop Company  
 MARION CENTER Forshey's Feed & Grain Company  
 MARTINSBURG Mason's, Inc., 182 Mead Avenue  
 MEADVILLE Keebler's Feed & Farm Supply  
 MONTOURSVILLE Storage Battery & Electric Service  
 NEW CASTLE A. B. C. Graff  
 NEW HOLLAND Hochstetler's Magneto Service, 243 E. Franklin Street  
 NEW PROVIDENCE Walter McVey  
 NORRISTOWN Edelen & Boyer Co., 1502 DeKalb Pike  
 PHILADELPHIA Cline-Thornton, Inc., 3307 Old York Rd.  
 Lawn & Golf Supply Co., 6701 Chew Avenue  
 Jack M. Lotsey, 863 N. 28th St.  
 Messick & English, 9240 State Road  
 The Ransome Corporation, 5526 Arch St.  
 Service Supply Corporation, 20th St. & Erie Ave.  
 Thompson Rubber Co., 5222 North Fifth St.  
 PHOENIXVILLE Lawn & Golf Supply Co., 647 Nutt Road  
 PITTSBURGH 15212 \* CONTRACTORS EQUIPMENT SERVICE CO.  
 1475 Brighton Road, N. S.  
 Vitte's Mower Center, 969 Castle Shannon Blvd.  
 PLYMOUTH MEETING L. B. Smith, Inc.  
 ST. MARY'S St. Mary's Super Service  
 SCRANTON Penn Auto Service & Supply, 711 Mineral Avenue  
 SHAMOKIN Shamokin Cycle Shop, 212 West Independence Street

SILVERDALE I. G. Rosenberger Company  
 SPRINGS (Somerset County) Miller Brothers  
 TOWER CITY Tallman Supply Co.  
 VERONA Certified Auto Parts, 730 Allegheny River Blvd.  
 WASHINGTON Kimble Farm Equipment, 2585 Jefferson Avenue  
 WATERFORD Troyer Equipment Company  
 WEST CHESTER Fruit Growers of Chester County  
 250 South Franklin Street  
 WEST READING Berkleigh Tractor Div., Seaman Mill Supplies  
 200 Penn Ave.  
 YORK Burgard Bros., West and Philadelphia Street

\* McCUNE & COMPANY, INC.  
 3721 Mahoning Avenue  
 Youngstown, Ohio 44515

### RHODE ISLAND

EAST PROVIDENCE J. J. Gregory & Son, Inc., 77 Highland Avenue

\* DIESEL ENGINE SALES & ENGINEERING CORP.  
 Fish Pier Road  
 Boston, Massachusetts 02210

### SOUTH CAROLINA

ANDERSON Foundry & Steel Company  
 CHARLESTON Craven Auto Electric Co.  
 COLUMBIA 29202 \* COLUMBIA SUPPLY CO., 823 Gervais Street  
 FLORENCE B. E. Richbours Small Eng. Serv., 815 South Church St.  
 GREENVILLE Greenville Implement Company  
 Battery & Electric Company  
 GREENWOOD Bourne Auto Parts Company  
 KINGSTREE King Equipment & Supply Co.  
 MARION Atkinson Implement Company  
 NEWBERRY Shealy Tractor & Implement Co.  
 ORANGEBURG Shulers Small Engine Service  
 ROCK HILL Hollman Battery & Ignition Company  
 SENECA Wightington Saw & Equipment Company  
 SPARTANBURG Spartan Automotive, Inc., 300 West Main Street

### SOUTH DAKOTA

ABERDEEN Paisley Auto Supply, Inc.  
 BELLE FOURCHE Hoeseth Auto Electric  
 BRITTON Thorpe Auto Company  
 BROOKINGS Sidles Company, 411 - 4th Street  
 CHAMBERLAIN Chamberlain Motor  
 FORT PIERRE Rankin Implement Company  
 GETTYSBURG Hottman Implement Company  
 HOWARD Frank J. Dold  
 HURON General Auto Electric  
 ISABEL Automotive Company  
 LEMMON Hersrud Implement Co.  
 McLAUGHLIN McLaughlin Implement  
 MITCHELL Mitchell Iron and Supply  
 PLATTE Home Implement Company  
 RAPID CITY Johnson Machine Company  
 REDFIELD Spink County Farm Implement  
 SELBY Jake Rabenberg Implement  
 SIOUX FALLS 57101 \* DAKOTA IRON, Box 934  
 STURGIS McKie International  
 WATERTOWN Marquardt's Service & Supply Co.  
 YANKTON Swenson Repair

### TENNESSEE

BRISTOL LeRoy M. Hull Company, 1201 West State Street  
 CHATTANOOGA 37401 \* NIXON MACHINERY & SUPPLY CO., INC.,  
 1300 Carter Street  
 DYERSBURG J. M. Collins Auto Parts

JACKSON Jackson Bearing Company  
 Wilson Outdoor Equipment Co.  
 JOHNSON CITY Young Supply Company  
 KINGSPOK Cox-Mills Machinery Co., 402 E. Market St.  
 KNOXVILLE \* Nixon Machinery & Supply Co., Inc.  
 4717 Clinton Highway  
 LEBANON Lebanon Auto Parts Company  
 MARYVILLE Lane Auto Services, 1703 East Broadway  
 MEMPHIS Choctaw, Inc., 1184 Tupelo  
 Esch Service & Supply Co., 1177 East Raines Road  
 Hawkins Equipment Company, 1475 Thomas Street  
 Master Sales Company, 2518 Lamar Avenue  
 Mid-South Small Engine Service  
 Union Auto Electric, 1017 Union Avenue  
 Williams Equipment & Supply Co., 2425 South Third St.

\* RCH DISTRIBUTORS, INC.  
 223 South Front  
 P. O. Box 2828,  
 Memphis, Tennessee 38102

NASHVILLE 37210 \* NIXON MACHINERY & SUPPLY CO., INC.  
 208 Crutchfield Avenue  
 Wilder Motor Co., 126 - 14th Ave., North  
 SO. FULTON Duke's Auto Parts Company

### TEXAS

ABILENE Hoppe Auto Electric Company, South First & Poplar  
 Oil Field Service & Equip., Box 1772, 1535 Walnut St.  
 ALICE Oilfield Motor Service, Drawer 90, 301 W. 1st  
 ALVIN Christianson-Keithley Company, Box 871  
 AMARILLO Wilson Battery & Electric Service, 618 Jackson Street  
 ANDREWS Magneto Service & Supply, 906 S. Main  
 ARLINGTON Witch Equipment Co., 343 North Bowen Rd.  
 ATHENS S. P. Barkley Company, South Carroll & Madole Streets  
 AUSTIN Austin Machine & Grinding Company  
 201 East First Street  
 BAY CITY M. J. Denn & Son, 1308 Avenue F  
 BAYTOWN Air Cooled Engine Service & Supply  
 1205 North 5th Street  
 BEAUMONT Oil City Tractors, Inc.  
 3999 South 11th Street (Box 710)  
 Teel's Maintenance & Supply Co., 1110 South 4th St.  
 BEEVILLE Roberts & McKenzie, Inc., Box 1030  
 BIG SPRING Hall Air-Cooled Engine Service, Box 1367  
 BONHAM Brown Tractor Company, Route #1  
 BORGER Radcliff Electric Co., 504 East Tenth  
 BOWIE Bowie Machine Works, Inc., Drawer 630  
 BRENHAM Washington County Tractor Co. Inc.  
 304 Lubbock (Box 885)  
 BROWNFIELD Brownfield Magneto & Electric Company  
 702 Lubbock Road  
 BROWNSVILLE Bill Grindle Auto Electric Company, 953 East Adams  
 BROWNWOOD Carlson's, Clark & Anderson Streets  
 BRYAN T & T Implement Company, Box 151  
 CLEBURNE Zimmerman Sons & Company, 1-3 East Henderson  
 CLEVELAND Gates Saw Company, 301 North Washington  
 CONROE Gates Saw Company, Box 733, 1/2 Mi. on Highway 75  
 CORPUS CHRISTI Russell's Machine & Supply, Inc.,  
 Box 1978, 110 North Chaparral  
 CORSICANA Stroube Implement Company, Ltd., Highway 75 South  
 CROCKETT Driskell Farm Service Company, Houston Highway  
 DALLAS 75247 \* HARLEY SALES COMPANY, 8005 Sovereign Row  
 Ben Griffin Tractor Company, 5220 Harry Hines Blvd.  
 Peerless Equip. Corp., 11091 Denton Drive, Box 20260  
 P. A. Ross Machinery Company, 2424 South Central  
 Expressway  
 DEL RIO Tim B. Cobb Hardware Company, 822 South Main Street  
 DENTON Travelstead Auto Supply Co., 215 East Hickory St.  
 EL CAMPO Industrial Motor Service, 1202 East Jackson  
 EL PASO Wes Kerns' Repair Shop, 1533 Bassett  
 Tri State Equipment Co., 1501 East Paisano Drive

FLORESVILLE Eschenburg Implement Company, 1326 3rd St.  
 FORT WORTH A & B Contractors Equipment & Supply Co., Inc.,  
 2101 Riverside Drive  
 George's Auto Parts, Inc., 905 Florence Street  
 FREDERICKSBURG Fredericksburg Machine & Appliance Co., Inc.,  
 105 East San Antonio St.  
 FREEPORT Parts, Inc., 623 North Gulf Boulevard  
 GALVESTON Island Marine Sales & Service, 4222 Broadway  
 National Cotton, Inc., 1828 Avenue C  
 Jaegers Incorporated, Box 36  
 GIDTINGS S & W Repair Shop, Box 712  
 GLADEWATER Rogers Magneto & Electric, 508 Second St.  
 GRAHAM Hamlin Auto Parts, 129 South Central  
 HAMLIN Smith & Jones, Box 391  
 HAMILTON  
 HEREFORD McRight Garage & Supply, 642 East Second Street  
 HILLSBORO Hillsboro Farm Machinery, 111-113 West Franklin  
 HOUSTON 77001 \* HARLEY SALES COMPANY, 4427 West 12th  
 Gaedcke Equipment Co., 5500 Navigation Boulevard  
 McKenzie Equipment Co., Inc.  
 9260 Bryant Street (Box 60460)  
 Witch Equipment & Supply Co., 5905 Schumacher  
 Katy Farm Equipment, Inc., Box 97  
 Kermit Engine & Electric, Box 1144  
 Magneto Sales & Service Co., 707 South Commerce  
 Burris Motor Service, 206 East Lee  
 Janssen Bros., Box 600  
 Yearly Battery Co. Ltd., Houston & Juarez  
 Magneto Sales & Service, 319 W. Marshall  
 Motor Machine Company, 1921 Avenue H  
 Lufkin Supply Company, 417 Lufkin Ave.  
 Power Supply Company, 305 E. Austin  
 Hoff Service, Inc., 500 South 10th Street  
 Air-Cooled Engine Supply, 344 E. Louisiana  
 Wes-Tex Equipment Co., Box 4397 (W. Highway 80)  
 Mission Auto Electric, W. Highway 83  
 Rutherford Machine Company, 100 South Calvin  
 Ladd Engineering Company, Box 75  
 Mallard Tractor Company, Box 289  
 Ditch Witch of South Texas, 1545 Highway 81 East  
 \* HARLEY SALES COMPANY, 701 County Road West  
 Nelson's Supply House, 88 West Cypress Ave.  
 J. B. Miller & Co., Box 1229  
 Anderson County Equipment Co., 806 West Oak  
 Radcliff Electric Company, Box 151, 519 S. Cuyler  
 Equipment Service Company, 2000 Balmorhea Highway  
 All County Supply Co., 123 S.E. Second, P.O. Box 847  
 W. O. Speck Machinery Company, 1000 Broadway  
 Spence Battery & Electrical Co., Box 1507  
 Auto Parts & Machine Co., 132 North Guadalupe  
 Tuttle Motor Company, Box 198  
 Kircher's Repair Shop, Box 266  
 Lamar Tractor Company, 2810 Avenue H  
 Rogers Machine Co., 113 East Concho  
 Catto & Putty, Inc., Box 2408, 510 Soledad St.  
 Gibtrac, Inc., 6625 South Flores Street  
 Wright Motor Company, 210 East Avenue A  
 Shipp Motor Company, 307-309 South Travis Street  
 Boehm Tractor & Auto Sales, Box 121  
 Y-Z Engineers Service, Box 176  
 The Banks Company, 120 Oak Avenue  
 Sweetwater Electric Company, 100 Elm Street  
 Farm Equipment Service, 2306 So. First St.  
 Ledwell & Son, Box 1106  
 Rodenbeck Auto Supplies, 525 West Highway  
 Acme Machinery Company, 5810 North Dixie  
 Bud's Automotive Machine & Supply, 1500 Cumberland  
 United World Supply Co., 301 N. George  
 The Motor Shop, 420 South 5th Street  
 Richards Equipment Co., 910 Franklin  
 C. R. Feaster Company, 418 South Rogers Street  
 Loessin Implement Company  
 Wharton Tractor Company, 1007/Richmond Road North  
 Mike-Carter Engine Works, 219 Indiana Avenue

UTAH

LOGAN Bullens, 1475 North Main  
 OGDEN Stegens Auto Service  
 PROVO Bradshaw Auto Parts Company, 335 West Center  
 SALT LAKE CITY 84110 \* ARNOLD MACHINERY COMPANY, INC.  
 433 West Second South Street  
 SPANISH FORK Bradshaw Auto Parts Company

VERMONT

RUTLAND Berkshire Tractor Co., 274 South Main St.  
 SOUTH BURLINGTON Parker Danner Co., 1901 Williston Road  
 (VERMONT STATE LINE)  
 WALPOLE, NEW HAMPSHIRE R. N. Johnson, Inc., Bellows Falls Rd.  
 \* DIESEL ENGINE SALES & ENGINEERING CORP.  
 Fish Pier Road  
 Boston, Massachusetts 02210

VIRGINIA

ANNANDALE Universal Cycle & Mower Company,  
 7575D Little River Turnpike  
 ARLINGTON Phillips Machinery & Tractor Co.,  
 2910 Jefferson Davis Hwy.  
 CHARLOTTESVILLE Desper Power & Equipment Co., Rt. 29 North  
 CHESAPEAKE G & S Equipment Co., Inc., 1335 South Military Highway  
 DANTE Phillips Auto Supply  
 DANVILLE Motor Parts & Equipment Co., 920 Riverside Dr.  
 FAIRFAX Krauser Equipment Co., 3301 Pickett Road  
 FARMVILLE Taylor-Forbes Equipment Co.  
 FREDERICKSBURG A. W. Mitchell Company  
 GLOUCESTER Power Systems Development, Box 738  
 HAMPTON Dixie Diggs Auto Parts, Inc.,  
 Cor. N. King St. & Pembroke Ave. P.O. Box 364  
 HARRISONBURG Whitesel Brothers  
 HILLSVILLE J. L. Harmon Lumber Company, P.O. Box 486  
 LEXINGTON Turpin's Supply Service, Route 4  
 LYNCHBURG Myers & Rhodes Equipment Co., Inc.  
 MARTINSVILLE Motor Parts & Equipment Co., Ten Liberty Street  
 NEWPORT NEWS W. L. Gleason Co., 3511 Jefferson Avenue  
 McIlhany Equipment Co., Inc., 499 Muller Lane  
 Highway & Industrial Equipment Co.  
 5630 Virginia Beach Blvd.  
 Land & Coates, Inc., 3505 Virginia Beach Blvd.  
 Ritchie Hardware & Implement Co., Inc.  
 \* PHILLIPS MACHINERY, INC.  
 Staples Mill Rd. at Greendale  
 Richmond Tractor Service, Inc., 7202 Brook Road  
 Baker Brothers, Inc., 1402 Williamson Road  
 McIlhany Equipment Co., Inc., P.O. Box 121  
 Phillips Auto Supply  
 Whitesel Brothers, Inc.  
 J AND E Auto Supply  
 Lupton Equip. Co., Inc., 560 N. Loudoun St.  
 R. P. Johnson Sons  
 \* ENGINE SALES & SERVICE CO., INC.,  
 919 Virginia Street, East  
 Charleston, West Virginia 25301  
 \* POTTER EQUIPMENT COMPANY, INC.  
 6200 N. Capitol Street, N.W.  
 Washington, D. C. 20011

**WASHINGTON**

**ABERDEEN** Grays Harbor Equipment Company  
**BELLINGHAM** Automotive Parts Service, 1322 State Street  
**BOTHELL** Walters Specialized Equipment  
**BREMERTON** Williamson's Machine Shop, 2612 Burwell  
**CENTRALIA** Ran's Auto Electric, 309 West Main  
**COLFAX** Colfax Farm Equipment, Inc., East 306 Third  
**EVERETT** Cordz Auto Electric, 2915 Rucker Avenue  
**LONGVIEW** Manthe Equipment Co., 1039 California Way  
**MOSES LAKE** Ross Automotive, 508 East Third  
**MT. VERNON** Piston Service Co., 410 Second Street  
**OKANOGAN** Hamilton Farm Equipment Center, Inc.  
**OLYMPIA** Central Auto Parts  
**OTHELLO** Preston Tractor Co. of Othello  
**PASCO** Pasco Motor Supply, Inc.  
**PORT ANGELES** Dobson's, P. O. Box 872  
**PROSSER** General Parts Supply  
**PUYALLUP** Ray Bock Equipment Company  
 11th N.W. at River Road  
**QUINCY** Quincy Truck & Implement Co.  
**SEATTLE 98134** \* STAR MACHINERY COMPANY, 241 Lander Street  
 Abel Service Company, 5326 Roosevelt Way N.E.  
 Motor Parts Machine, 817 East Pike  
**SPOKANE 99202** \* STAR MACHINERY COMPANY, East 415 Sprague Avenue  
 Andrews Equipment Service, East 4620 Trent  
 Skaggs Automotive Supply, Inc., 1107 West Second  
 Motor Parts & Equipment Co., 1745 Jefferson  
**TACOMA** Wheeler's Gas Engines, 2604 E. Evergreen Blvd.  
**VANCOUVER** Harry's Small Engine Specialties, 2311 Main St.  
**WALLA WALLA** Walla Walla Motor Supply, Inc.  
**WENATCHEE** Wells & Wade  
**YAKIMA** Turner Implement Company, 2006 South First Street

\* INDEPENDENT DISTRIBUTORS

2355 N.W. Quimby St.  
 Portland, Oregon 97210

**WEST VIRGINIA**

**BECKLEY** Raleigh Motor Sales, Inc., P. O. Box 1370  
**BLUEFIELD** Graseclose Auto Electrical  
**CHARLESTON 25301** \* ENGINE SALES & SERVICE CO., INC.  
 919 Virginia Street, East  
**CLARKSBURG** Craig Motors  
 West Virginia Mine Supply Co., 212 Ohio Avenue  
**FAIRMONT** Craig Motor Service Company  
**HUNTINGTON** Contractors Equip. & Supply Co., 2867 Third Avenue  
**LEWISBURG** Greenbrier Tractor Sales  
**MORGANTOWN** Ted's Auto Electric  
**MOUNDSVILLE** Gordon Auto Parts, Second & Cedar  
**PARKERSBURG** Hartman Oil & Gas Co., 841 Janette St.  
**SPENCER** Dependable Pipe & Supply  
**WESTON** Craig Motor Service Co.  
 Lovett Welding & Repair, Route #4, Box 54

\* CONTRACTORS EQUIPMENT SERVICE COMPANY

1415 Brighton Road, N.S.  
 Pittsburgh, Pennsylvania 15212

\* POTTER EQUIPMENT COMPANY, INC.

Washington, D. C. 20011  
 6200 N. Capitol Street, N.W.

**WISCONSIN**

**ANTIGO** Gresch Implement Company, 613 5th Ave.  
**APPLETON** Schreiter Auto Supply, 603 West College Avenue

**ASHLAND** Farm Equipment Service Company, Inc., 1314 W. Front St.  
**BARABOO** Kinnaman Saw & Magneto Service, Rt. 4, Hwy. 12  
**EAU CLAIRE** Johnson Motor & Supply Co., 508 Water Street  
**FOND DU LAC** Houston's Small Engine & Auto Supply, Inc.,  
 108 South Macy Street  
**GREEN BAY** Paynter Equipment Corporation, 1734 Cass Street  
 Van's Supply & Equipment, 314 No. Madison St.  
**JANESVILLE** Wilke Motors, 215 East Milwaukee  
**KENOSHA** Highway Service Garage, Rt. 3, Box 470  
**LaCROSSE** Ed's Auto Electric, 219 Vine Street  
**MADISON** Engine Power, Inc., 2501 So. Stoughton Road  
**MANITOWOC** Seibold Implement Company, Rt. 1, Box 285  
**MARSHFIELD** Snowmobile Sales, Inc., 309 East 29th Street  
 Wegner's Welding Repair, 315 N. Central  
**MAYVILLE** Mayville Welding Industries, 520 Dayton  
**MEDFORD** The Eggert Company, 127 Broadway  
**MERRILL** Knispel & Krueger, Inc., 108 N. Genesee St.  
**MILWAUKEE 53218** \* ENGINE POWER, INC., 11811 W. Silver Spring Drive  
 Motor Grinding & Parts Company  
 817 W. National Avenue  
 2529 W. North Avenue  
**OCONOMOWOC** L. F. George Company, 728 East Wisconsin Avenue  
**OSHKOSH** The Lake View Shop, 2627 Harrison  
**PORTAGE** Portage Magneto & Electric Service, 11 N. Main Street  
**PRAIRIE Du CHIEN** Valley's Small Engine Service, 667 East Blackhawk Drive  
**RICHLAND CENTER** Moore Electric Service, 535 W. Seminary  
**STURGEON BAY** Len Scharfner Implement Co., County Trunk S., Rt. 6  
**STURTEVANT** Henry Rohner Implement Company  
**SUN PRAIRIE** Hanley Implement Company, 641 W. Main St.  
**SUPERIOR** Neuman Automotive Service, 1111 Ogden Avenue  
**TOMAH** Kennedy Automotive Supply Company, 906 Superior Ave.  
**WAUSAU** Buch Farm Equipment, 102 W. Bridge St.  
**WEST ALLIS** J. H. Medinger Co., 9513 We. Greenfield Avenue  
**WISCONSIN RAPIDS** B & B Implement & Welding, Rt. 4 - Box 541

**WYOMING**

**BUFFALO** Johnson County Implement Company  
**CASPER** Studer Tractor & Equipment Company  
**CHEYENNE** Wilson Equipment Company  
**DOUGLAS** Gene L. Payne Co.  
**GILLETTE** Axel W. Ostlund & Son  
**RIVERTON** Valley Implement Company  
**ROCK SPRINGS** Wyoming Automotive  
**SHERIDAN** Auto Electric Company  
**TORRINGTON** Keeley Auto Electric Co.  
**WHEATLAND** Burzlaff Implement Co.  
**WORLAND** Fausset Implement Company

\* CENTRAL EQUIPMENT COMPANY

4477 Garfield  
 Denver, Colorado 80216

\* MIDLAND IMPLEMENT COMPANY, INC.

402 Daniels  
 Billings, Montana 59101

\* ARNOLD MACHINERY COMPANY, INC.

433 West Second South Street  
 Salt Lake City, Utah 84110

# WISCONSIN MOTOR CORPORATION

## AUTHORIZED SERVICE CENTERS

### CANADA

The following concerns have service part stocks, facilities and trained personnel to render complete service on Wisconsin Air-Cooled Engines. We recommend you work through these service centers on your Wisconsin engine service requirements.

#### \* DISTRIBUTORS

#### ALBERTA

BROOKS  
CALGARY

CAMROSE  
CARBON  
CLARESHOLM  
DRUMHELLER  
EDMONTON

GRANDE PRAIRIE  
HIGH PRAIRIE  
LETHBRIDGE

MANNING  
MEDICINE HAT

OLDS  
OYEN  
PEACE RIVER  
PINCHER CREEK  
RED DEER  
SPIRIT RIVER  
STETTLER  
TABER  
TROCHU  
VEGREVILLE  
VERMILION  
VIKING  
VULCAN  
WAINWRIGHT  
WESTLOCK  
WETASKIWIN

Park Sales and Service  
\* MUMFORD, MEDLAND, LIMITED  
5711 - 6th Street, S.E.  
Crawford & Company, Ltd.  
Wright Motors Ltd.  
TNT Equipment  
E. O. Parry Auto & Farm Machinery, Ltd.  
\* MUMFORD, MEDLAND, LIMITED  
10809 - 105th Ave.  
Renown Industries, Ltd., 10344 - 59th Ave.  
Wm. Shannon & Sons Implements Ltd.  
Ike's Modern Motors  
Oliver Chemical Company, Ltd.  
3 Avenue & 9 Street, North  
Turner Bros. (Manning) Ltd.  
Foughty Cycle Shop  
580 Parkview Drive  
Stauffer's Auto Electric, Ltd., Box 1060  
Jardine's Equipment Ltd.  
Moro Machine Shop  
Stucky's Farm Service  
Loveseth Ltd., 5104 Gaetz Avenue  
D. Ross & Sons  
Modern Machine Shop (Stettler) Limited  
Farm Equipment Centre  
J. E. Frere & Son  
Arychuk Service  
Hornsby Small Engine Service  
Taylor Garage Ltd.  
Richardson & Gould Ltd.  
Hughie's Auto Electric  
A. Miller Farm Equipment Ltd., P. O. Box 478  
Pahal Motors, Limited, P. O. Box 1688

#### BRITISH COLUMBIA

CHILLIWACK  
DAWSON CREEK  
KAMLOOPS  
KELOWNA  
NANAIMO  
NELSON  
OLIVER  
PENTICTON  
PRINCE GEORGE  
SALMON ARM  
VANCOUVER

C. R. Fortin & Son  
125 Trans-Canada Highway West  
Bob Whyte Industrial Equipment, 1549-95th Avenue  
Stan Steele Limited  
142 - 2nd Avenue  
Kelowna Industrial Supply Company,  
274 Lawrence Avenue  
The Nanaimo Foundry & Engineering Works Limited  
100 Comox Road  
T. Conners Diamond Drilling  
Imperial Motors, P.O. Box 946  
L. R. Bartlett Ltd.  
166 Westminster Ave. W.  
Northern Magneto and Electric  
975 Second Avenue at Queen Street  
Peterson Bros. (Salmon Arm) Ltd.  
\* PACIFIC ENGINES & EQUIPMENT, LTD.  
40 East Cordova Street  
Magneto Sales & Service, 126 Gore Avenue

VERNON  
VICTORIA

McBain Air-Cooled Engine Co.  
1968 West Georgia Street  
Western Air Cooled Engines Ltd.,  
1859 West Georgia Street  
Jack Fuhr Limited, 3405 Bernard Avenue  
Mayhew & Strutt Ltd., 2300 Douglas Street

#### MANITOBA

ALTONA  
BALDUR  
BEAUSEJOUR  
BOISSEVAIN  
BRANDON  
CARMAN  
DAUPHIN  
KILLARNEY  
MANITOU  
MELITA  
MORDEN  
NEEPAWA  
PORTAGE la PRAIRIE  
ROSENORT  
RUSSELL  
ST. LAZARE  
SHOAL LAKE  
STEINBACH  
SWAN RIVER  
VIRDEN  
WINNIPEG

Wiebe's Garage Limited  
Ramage & Sons  
Stefaniuks Garage  
Dixons Auto Service  
Frank Lawson & Sons  
Johnston Farm Supply  
B-B Farm Supply  
H. L. Freeman & Son  
D. Voth & Sons  
Griffith Brothers  
Hamms Garage  
William Whitmore  
Dillon Electric Limited  
352 Saskatchewan Avenue East  
Rosenort Motors  
Clement's Farm Equipment  
Fouillard Implements Exchange  
Lake Motors  
Thomas Wiebe & Company, Limited  
C. P. Sorensen & Son, P. O. Box 359  
Runion's Farm Equipment  
\* MUMFORD, MEDLAND, LIMITED  
576 Wall Street

#### NEW BRUNSWICK

BATHURST  
EDMUNDSTON  
FREDERICTON  
RIVERVIEW  
ST. JOHN

Burns Equipment Ltd.  
Bell Equipment Ltd., 159 Canada Road  
Engine Machine Shop & Supply Limited  
\* CONSOLIDATED ENGINES & MACHY. CO. LTD.  
Coverdale Road  
(P. O. Box 848, Moncton)  
Lounsbury Industrial Ltd., 415 Rothesay Ave.

#### NOVA SCOTIA

DARTMOUTH  
KENTVILLE  
SYDNEY  
TRURO

\* SEABOARD GM DIESEL LTD.  
710 Windmill Road  
Scotian Gold Co.-Op. Ltd.  
Atlantic Spring & Machine Co., Ltd.  
Wilson Equipment Ltd.

## ONTARIO

**BELLEVILLE** Belleville Auto Electric, 84 Grier Street  
**BRANTFORD** Riverview Automotive Machine Co., 120 Water St.  
**BURLINGTON** Duke Lawn Equipment Ltd.  
**CHATHAM** Norton Smith Cycle Service, 181 Thames St.  
**FORT WILLIAM** Acklands Ltd., 831 May Street  
**HAMILTON** Capital Construction Equipment Co. Ltd.  
 67 Frid Street  
 Standard Engines, Equip. & Supplies Ltd.  
 516 Parkdale Ave. N.  
**HUNTSVILLE** G & G Huntsville Automotive Supply Ltd.  
 9 Minerva Street  
**KINGSTON** Kingston Auto Motor Rebuilders, 40 James St.  
**KITCHENER** Jacobs Tractor & Equipment, Ltd.,  
 1138 Victoria Ave. N.  
**LONDON** E. P. Abey Limited, Wharnccliffe Road, South  
**NORTH BAY** Ray Gordon Equipment Rentals Ltd.  
 164 Lakeshore Drive  
**OSHAWA** Herb Robinson Wholesale Ltd., 72 Richmond St.  
**OTTAWA** Craig Construction Equipment Ltd.,  
 2940 Baseline Road, Bell's Corner's Post Office  
 Welch & Johnston Ltd., 472-476 Bank Street  
**OWEN SOUND** Slater's Auto Electric Ltd., 260 8th St. E.  
**PETERBOROUGH** MacLeod Motors (Peterborough) Ltd.  
**RENFREW** Powell's Auto Service Ltd.  
**ST. CATHERINES** D. A. Dalziel Equipment Ltd., 251 St. Paul St., West  
**SARNIA** Lambton Equip. Co., 792 Phillip Street  
**SAULT STE. MARIE** Bert's Auto Supply Limited, 415 Queen St. E.  
**SUDBURY** V.O.B. Heavy Equipment Repair Ltd.  
 187 Sillpa Street  
 Yuill & Craig Ltd., 378 Whittaker Street  
**TILLSONBURG** Davis Electric, 390 Simcoe Street  
**TIMMINS** Harnden and Newell Ltd., 271 First Avenue  
**TORONTO 520** \* CONSOLIDATED ENGINES & MACHY. CO. LTD.  
 3 Bestobell Road  
 M. L. Baxter Ltd., 1900 St. Clair Ave. West  
 Builders Tool Supplies, Ltd., 1210 Caledonia Road  
 Herc Industrial Engines, Ltd.,  
 37 Minford Avenue (Scarborough)  
**TRENTON** Quinte Machine & Repair Co., 23 Balsam Street  
**WALLACEBURG** Labombards (Wallaceburg) Ltd.,  
 330 Selkirk St.  
**WESTON** Marathon Equipment & Supply, Ltd., 88 Signet Drive  
**WINDSOR** Windsor Automotive Supply, 649 Wyandotte St. E.  
**WOODBRIIDGE** Humber Automotive Limited

## PRINCE EDWARD ISLAND

**CHARLOTTETOWN** J. H. England Equipment  
 \* CONSOLIDATED ENGINES & MACHY. CO.,  
 Moncton, New Brunswick

## QUEBEC

**BAIE COMEAU** Specialites Automobiles Enr., 174 Boul. Lasalle  
**CHICOUTIMI** Perron Equipment, Inc., 234 Blvd. Lamarche  
**MONTREAL** (9) \* CONSOLIDATED ENGINES & MACHY. CO. LTD.  
 8550 Delmeade Rd. (TOWN OF MT. ROYAL)  
 Crankshaft Grinders Inc., 226 Young St.  
 Engine Rebuilders Ltd., 6389 St. Lawrence Blvd.  
 J. A. Faguy & Sons Limited, 750 Montee de Liesse  
 James W. Halls & Sons, Ltd., 883 Montee de Liesse  
 International Electric Co., Ltd., 6500 Upper Lachine  
 Magneto Auto Electric Ltd.,  
 8500 - 4th Ave. Ville D'Anjou  
 Simplex Motor Parts Ltd., 2323 Des Carrieres

## QUEBEC CITY

General Diesel Incorporated, 101 Henderson Street  
 Quebec Gas and Diesel Engines Ltd.,  
 395 Boul. des Cedres  
 Talbot Equipment Limited, 205 St. Paul Street  
 Marcel Rochette Ltee., 138 rue Leonidas  
**RIMOUSKI** J. S. Levesque, 107 Rue Fraser  
**RIVIERE du LOUP** Maska Auto Electric Reg'd., 550 Vaudreuil St.  
**ST. HYACINTHE** Pridex ENR, 230 St. Jean Baptiste Blvd.  
**ST. PHILOMENE** International Electric Co., Ltd., 335 Laure St.  
**SEPT-ILES** Crankshaft Grinding & Diesel Service, Inc.  
**SHERBROOKE** 1175 Galt St. East  
**TROIS RIVIERES** Stanley Motors & Equip. Ltd., 1908 St. Philippe St.

## SASKATCHEWAN

**ASSINIBOIA** Harvey's Hardware Ltd.  
**AVONLEA** Nelson Motors Ltd.  
**CANORA** Acme Motors & Implements Ltd.  
**CARLYLE** Humphries Garage  
**CARNDUFF** R - M West End Motors  
**CARROT RIVER** C. R. Sales & Service  
**CHOICELAND** Lloyd R. White Farm Equipment  
**CUTKNIFE** Finley's Auto & Farm Supply Ltd.  
**DAVIDSON** Davidson Trailer Court  
**DINSMORE** A. McLellan  
**ESTEVAN** Kendall's Auto Electric  
**ESTON** Farmer's Supply Co.  
**FRANCIS** S. J. Helfrick & Sons  
**GLENAVON** Evans Motors  
**GRENFELL** Schlamp's Garage  
**GULL LAKE** A & P Motors  
**HUMBOLDT** Hergott Farm Equipment Limited  
**IMPERIAL** Art Ulmer  
**KAMSACK** Kamsack Co-operative Association Ltd.  
**KINDERSLEY** Halpanny Agencies  
**LANDIS** Landis Co-Op Association  
**LEADER** Lawrence Nagel  
**LLOYDMINSTER** Mayston Auto Electric & Machy. Ltd., 4402 - 49 Ave.  
**LUSELAND** Luseland Motors  
**MARSDEN** Forster Brothers  
**MEACHAM** Meacham Service  
**MEADOW LAKE** Auto & Tractor Supply Company, Ltd.  
**MELFORT** Creurer Bros.  
**MELVILLE** Melville Consumers Co-Op Association Ltd.  
**MILESTONE** McManus Bros.  
**MOOSE JAW** Moose Jaw Distributing Company  
**MOOSOMIN** Ranson Farm Equipment Ltd.  
**NIPAWIN** Rourke's Service Centre  
**NORTH BATTLEFORD** Hornsby & Son, 1022 - 102nd St.  
**OGEMA** Fritz Frank Garage  
**OUTLOOK** Outlook District Sales  
**PELLY** Campbell's Garage Limited  
**PONTEIX** Ponteix Central Garage Ltd.  
**PRINCE ALBERT** P. A. Electric Service Centre Ltd., 29 - 11th St. E.  
**RADVILLE** E. E. Bourassa & Sons  
**REGINA** \* MUMFORD MEDLAND LTD., 1250 St John St.  
**ROCANVILLE** Goodman's Esso Servic.  
**ROSETOWN** G. L. Conlin & Son Ltd.  
**SASKATOON** Lambert Electric Ltd., 114 - 120 Idylwyld Drive  
 \* MUMFORD MEDLAND LTD., 1729 Ontario Street  
**SHAUNAVON** John's Auto Electric  
**SHELLBROOK** Moker & Thompson Ltd.  
**SOUTHEY** Southey Motors  
**SPIRITWOOD** Green Line Equipment  
**STRASBOURG** E. E. Erickson  
**SWIFT CURRENT** Houston Equipment, Ltd.  
**TISDALE** E. G. Groat  
**UNITY** Krips (1958) Ltd.  
**WATROUS** Findley Machine Shop Ltd.  
**WEYBURN** Terry's Repair  
**WYNYARD** Lakeview Farm Equipment  
**YORKTON** Air Cooled Engine Service. 26 - 4th Avenue

# WISCONSIN MOTOR CORPORATION

## WORLD WIDE DISTRIBUTION

The following concerns have service part stocks, facilities and trained personnel to render complete service on Wisconsin Air-Cooled Engines. We recommend you work through these service stations on your Wisconsin engine service requirements.

### \* DISTRIBUTORS

#### ALGERIA

ALGER \* Hamelle Afrique  
89 Avenue de Tripoli  
P. O. Box 71 Hussein - Dey

#### ARABIAN GULF

KUWAIT \* Al-Khonaini Al-Katami Trading & Contracting Co.,  
P. O. Box 593

#### AUSTRALIA

NEW SOUTH WALES Ronaldson Bros. & Tippett Ltd.  
16 Warren Avenue, Bankstown  
QUEENSLAND Ronaldson-Tippett (Qld.) Pty. Ltd.  
81 Jurgens Street, Woolloongabba  
SOUTH AUSTRALIA Finsbury Sales & Service (S.A.) Pty. Ltd.  
570 Torrens Road, Finsbury  
TASMANIA Eric E. Howard and Son Pty. Ltd.  
170 Murray Street, Hobart  
Eric E. Howard and Son (Launceston) Pty. Ltd.  
177 Brisbane Street, Launceston  
VICTORIA \* Ronaldson Bros. & Tippett Ltd.  
P. O. Box 465, Ballarat  
Ronaldson Bros. & Tippett Ltd.  
168-174 Dorcas Street, South Melbourne, S. C. 5  
WESTERN AUSTRALIA Venables Service Pty. Ltd.  
97-101 Oxford Street, Leederville  
Barrow Linton Pty. Ltd.  
763-767 Wellington Street, Perth.

#### BAHAMA ISLANDS

GRAND BAHAMA Bahamas Tractor & Equipment, Ltd.  
P. O. Box 128, Freeport  
NASSAU \* Bahamas Tractor & Equipment Ltd.  
P. O. Box 638

#### BARBADOS (B.W.I.)

BRIDGETOWN \* The Entage Electrical Co., Ltd.

#### BELGIUM

BRUSSELS \* Materiels & Matériaux de Construction  
en Belgique S.A.  
710-714 Chaussee de Louvain

#### BERMUDA

HAMILTON \* Masters Ltd

#### BOLIVIA

LA PAZ \* Industrial Agencies (Bolivia) Ltda  
Avenida Montes No. 731  
Cajon Postal No. 2449  
ORURO \* Industrial Agencies (Bolivia) Ltda  
P. O. Box 430

#### BOTSWANA

GABERONES Construction Equipment Supply Co., Ltd.  
\* Barlow's Tractor & Equipment Co., Ltd.  
P. O. Box 291  
Salisbury, Southern Rhodesia

#### BRAZIL

AMAZONAS  
Manaus Industria e Comercio Bomfim S.A.  
Rua Marcilio Dias, 66/68  
CEARA  
Fortaleza J. Torquato Comercio e Industria S.A.  
Rua Borao do Rio Branco, 705  
GUANABARA  
Rio de Janeiro \* Fonseca Almeida Comercio e Industria S.A.  
Rua Primeiro de Marco, 112  
P. O. Box 422-ZC-00  
Luiz F. Braga Com. Ind. S.A.  
Rua Riachuelo, 257-A  
MARANHAO  
Sao Luis Companhia Importadora e Exportadora Moraes  
Av. Magalhaes de Almeida, 300  
MINAS GERAIS  
Belo Horizonte Cia. Fabio Bastos Comercio e Industria  
Av. Parana, 472  
Governador Valadares Cia. Fabio Bastos Comercio e Industria  
Rua Barbara Heliodora, 393  
Itajuba Guaita-Comercio de Automoveis S.A.  
Praca Dr. Wenceslau Braz, 92  
Juiz de Fora Cia. Fabio Bastos Comercio e Industria  
Rua Halfeld, 345  
Sete Lagoas Jose da Rocha & Cia. Ltda.  
Rua Teofilo Marques, 31  
Varginha Auto Varginha S.A.  
Praca Getulio Vargas, 215  
PARA  
Belem Higson & Co. (Para) Ltd.  
Praca Visconde do Rio Branco, 23/39  
PARANA  
Curitiba Hermes Macedo S.A. - Importacao e Comercio  
Rua Joao Negroao, 595/605  
PIAUI  
Parnaiba Neves & Cia.  
Av. Pres. Getulio Vargas, 293  
Teresina Neves & Cia.  
Rua Alvaro Mendes, 1.253  
RIO DE JANEIRO  
Niteroi Comag S.A. Maquinas Agricolas e Industriais  
Av. Feliciano Sadre, 578

**RIO GRANDE DO SUL**

Porto Alegre

Comercial Trilho Otero S.A.

Rua Voluntários da Pátria, 572

Resende

Braille &amp; Cia.

Rua Luiz Barreto, 19

Valença

Osário Duque de Souza

Rua Padre Luna, 33

**SANTA CATARINA**

Chapeco

Irmaos Baldissera &amp; Cia.

Av. Getulio Vargas, 1.681

**SAO PAULO**

Sao Paulo

Fonseca Almeida Comércio E. Industria S.A.

Caixa-Postal 8776, Avenida Ipiranga, 344

Maquibras S.A. - Maquinas e Equipamentos

Av. Gal. Olimpio da Silveira, 332

Cia. Hama-Com. Industria e Importacao

Rua Florencia de Abreu, 464

**BRITISH HONDURAS**

BELIZE

\* The Belize Supply Co., Ltd

P.O. Box 542

**CAMEROON**

DOUALA

\* Hamelle Afrique

P. O. Box 4041

YAOUNDE

\* Hamelle Afrique

P. O. Box 117

**CHILE**

CONCEPCION

Importadora Y. Comercial Del Sur S.A.

"IMCOSUR" Barros Arana 730 - Casilla 55 C

OSORNO

Importadora Y. Comercial Del Sur S.A.

"IMCOSUR" Ramirez 957 - Casilla 520

SANTIAGO

\* Sociedad General De Comercio S.A. SOGECO

Carmen No. 8

Casilla 904

VALPARAISO

Sociedad General De Comercio S.A.

"SOGECO" Salvador Donoso 140 2 esq.

Pudeto - Casilla 208-V

**COLOMBIA**

BARRANQUILLA

General Sales Corporation Ltda.

Calle 37 No. 46-03

Tracey &amp; Compania S. A.

Carrera 44 Nro. 36-29

BOGOTA

\* Motores Wisconsin de Colombia S.A.

Carrera 12 No. 16-73

Apartado Aereo No. 6864

Ambrosi &amp; Cia. Ltda

Calle 13 Nro. 19-57

Ignacio Gomez &amp; Cia.

Calle 13 Nro. 31-04

Mecanelectro Ltda.

Calle 13 Nro. 18-24

Riccardi &amp; Cia. Ltda.

Carrera 12 Nro. 16-73

Tracey &amp; Compania S. A.

Calle 13 Nro. 12-42

BUCARAMANGA

Garcia Cadena &amp; Co. Ltda.

Carrera 15 Nro. 31-49

Penagos Hermanos Ltda.

Carrera 18 Nro. 31-42

CALI

General Sales Corporation Ltda.

Calle 25 No. 3-36

Konietzko &amp; Cia. Ltda.

Carrera 7a. Nro. 13-69

Mecanelectro Ltda.

Carrera 1 Nro. 22-67

Tracey &amp; Compania S. A.

Calle 14 Carrera 6

Distribuidora del Gas del Norte

Avenida 5 Nro. 12-35

Jaimes Hermanos Ltda.

Calle 11 Avenida 7a.

Herramientas &amp; Equipos

Calle 14 Nro. 3-23/25

Tracey &amp; Compania S. A.

Carrera 22 Nro. 17-30

Mecanelectro Ltda.

Carrera Bolivar #41-28

Peter Santa-Maria &amp; Cia. Ltda.

Calle 50 No. 53-2

Tracey &amp; Compania S. A.

Carrera 51 Nro. 45-111

Almacen "La Favorita"

Cabrera Escovar Calderon Ltda.

Carrera 51 Nro. 11-46

Casa Alemana

Calle 19 Nro. 10-15

CUCUTA

Jaramillo &amp; Cia.

Almacen Pintuco

SAN VICENTE (Santander)

Miguel Rodriguez

Carrera 11 Nro. 11-18

TUMACO

Almacenes Mira

ZAPATOCA

Soto Diaz &amp; Cia. Ltda.

Carrera 6 Nro. 9-73

**REPUBLIC of the CONGO**

KINSHASA

\* Bureau Technique Bia

Boite Postale 8843

Kinshasa 1

Republique Democratique du Congo

LUBUMBASHI

\* Bureau Technique Bia

Post Office Box 1874

\* Bureau Technique Bia

123 Rameistraat

Overijse, Belgium

**CONGO REPUBLIC**

BRAZZAVILLE

\* Hamelle Afrique

P. O. Box 107

POINTE-NOIRE

\* Hamelle Afrique

P. O. Box 182

**COSTA RICA**

SAN JOSE

\* Aycarco Limitada, Apartado 1621

Carretera La Uruca

**DAHOMAY**

COTONOU

\* Hamelle Afrique

P. O. Box 124

**DENMARK**

COPENHAGEN

\* Aktieselskabet Dansk Wimex

Hauchsvej 12

**DOMINICAN REPUBLIC**

SANTO DOMINGO \* The General Sales Co. C. Por A.  
Apartado 746

**ECUADOR**

GUAYAQUIL \* Organizacion Comercial Vallejo Araujo, S.A.  
Ave. 9 de Octubre 721-723  
P. O. Box 717

QUITO \* Organizacion Comercial Vallejo Araujo, S.A.  
P. O. Box 245

**EGYPT (U.A.R.)**

CAIRO \* The Tractor & Engineering Company S.A.E.  
P. O. Box 366

**EL SALVADOR**

SAN SALVADOR \* Salvador Machinery Co. S.A.  
Boulevard Ejercito Nacional  
P. O. Box 125

**ENGLAND**

GLOUCESTER \* Power Units & Equipment Co.  
The Gloucester Trading Estate  
Hucclecote

**REPUBLIC OF FINLAND**

HELSINKI \* Machinery Oy  
P. O. Box 10129

**FRANCE**

BEZONS, (Seine-&-Oise) \* Union Automobile Technique et Commerciale  
53 Rue Claude-Bernard

**REPUBLIC OF GABON**

LIBREVILLE \* Hamelle Afrique  
P. O. Box 31

**GRAND DUCHY OF LUXEMBOURG**

Ricon G.M.B.H.  
Siesmayerstrasse 6  
Frankfurt/Main, Germany

**GREECE**

ATHENS \* George A. Makris  
30 Petraki Street

**GUAM**

AGANA \* International Equipment of Guam, Inc.  
P. O. Box B

**GUATEMALA**

GUATEMALA CITY \* Equipos Mecanicos de Guatemala, S.A.  
Boulevard Tecun Uman 4-59, Z.9  
P. O. Box 472  
Guatemala, Guatemala, C. A.

**GUYANA**

GEORGETOWN \* J. P. Santos & Co. Ltd.  
54 & 55 Water Street

**HAITI**

PORT-au-PRINCE \* Charles Fequiere & Cie.  
81, Rue Pavée  
& 77 Rue Christophe Colomb  
P. O. Box 398

**HONDURAS**

CHOLUTECA Casa Comercial Mathews, S.A.  
TEGUCIGALPA, D.C. \* Casa Comercial Mathews, S.A.  
P. O. Box 39  
SAN PEDRO \* Casa Comercial Mathews, S.A.  
SULA, D.D. P. O. Box 37

**ICELAND**

REYKJAVIK \* Elding Trading Company

**INAGUA (BAHAMA ISLANDS)**

MATTHEWTOWN \* Morton Bahamas Ltd.

**INDIA**

BOMBAY 1, \* Atul Engineering Co.  
P. O. Box 588  
140 Meadows St.

**INDONESIA**

DJAKARTA \* P. T. Masayu Trading & Industrial Co.  
P. O. Box 2107

**IRAN**

TEHERAN \* Sherkat Diesel Abzar  
646 Saadi Avenue

**IRAQ**

BAGHDAD \* A. M. Khayat Inh. Co.  
Sinek Street

**ISRAEL**

TEL-AVIV \* Motors and Trucks Co., Ltd.  
P. O. Box 509

**ITALY**

MILANO \* Eugenio Silvani S. R. I.  
Via Oropa 3

**REPUBLIC OF THE IVORY COAST**

ABIDJAN \* Hamelle Afrique  
P. O. Box 1326

**JAMAICA**

KINGSTON \* Masterton, Limited  
23-25 Hanover Street, P. O. Box 73

**JAPAN**

TOKYO \* Frazar Shokai Kabushiki Kaisha  
Room 401, Yaesu Bldg.  
6, 2-Chome, Marunouchi, Chiyoda-Ku

\* Frazar & Company, Inc.,  
233 Broadway  
New York, N. Y. 10007

**KOREA**

SEOUL \* Frazar & Company, Inc  
Bando Building, Room 624  
International P. O. Box 1108

\* Frazar & Company, Inc.,  
233 Broadway  
New York, N. Y. 10007

**LEBANON**

BEIRUT \* Abdunnur Commercial & Engineering Co.

**LIBERIA**

MONROVIA \* Liberia Tractor & Equipment Co.  
P. O. Box 299  
United Nations Drive

**LIBYA**

TRIPOLI \* Tripoli Sales Company  
Suani Road 1½ KM  
P. O. Box 2219

**MALAGASY REPUBLIC**

TANANARIVE Hamelle-Afrique  
P. O. Box 642

**MALAWI**

BLANTYRE \* Construction Equipment Supply Co., Ltd.  
P. O. Box 526

**MALAYSIA (EAST)**

SABAH \* Honiron Sandakan Branch  
P.O. Box 1048  
Sandakan

**MARTINIQUE (F.W.I.)**

FORT-DE-FRANCE \* Guy Vieules  
P.O. Box 233

**MEXICO**

AGUASCALIENTES J. Ramiro del Villar  
Emiliano Zapata No. 121, Aguascalientes

BAJA CALIFORNIA Electronica Arechigo  
Hidalgo No. 316, La Paz  
Proveedora Industrial de Ensenada S. A.  
Calle Frente, Ensenada

CAMPECHE Luis F. Romero Nicollau  
Calle. 10x59 No. 7, Campeche

CHIAPAS Amin Aramoni y Cia S. de R. L.  
La Pontiente 38 y 2a Ave. Sur, Tuxtla Gutierrez  
Ing. Carlos Garcia Sarabia  
Central Oriente No. 16-B, Tapachula  
Jorge Figueroa B.  
Av. Central No. 27, Tuxtla Gutierrez  
Maquinaria e Implementos de Tapachula  
2a. Ave. Norte Mina No. 2, Tapachula  
Roberto Pulido G.  
Calle 20 No. 45, Comitán  
Vincente Yannini  
Madero No. 18, San Cristobal Las Casas

CHIHUAHUA Radamientos Y Maquinaria, S.A.  
Ave. Niños Héroes No. 501, Chihuahua

COLIMA Radiolandia, S. A.  
G. Barreda No. 27, Colima

DURANGO Menvil Motors, S. A.  
20 de Noviembre y Libertad, Durango

GUANAJUATO Bombas y Motores del Bajío S. A.  
Samuel W. Jones No. 1, Irapuato  
Equipos de Bombeo y Maquinaria Agrícola S. A.  
Manuel Doblado No. 5, Celaya  
Maquinaria y Refacciones  
Hidalgo No. 146, Leon

GUERRERO Equipos y Herramientas del Sur, S. A.  
Ave. Cuauhtémec No. 81, Acapulco  
Jeronimo Gaona Santamaría  
Juárez y Reforma, Cd. Altamirana  
Moto-Bombas y Refacciones del Pacifico  
Ave. Cuauhtémec No. 90-1, Acapulco

HIDALGO Central de Maquinaria de Hidalgo S. A.  
Av. Juarez No. 302, Pachuca  
El Bazar Universal, S. A.  
Hidalgo No. 300, Ote., Tulancingo  
Maquinaria Del Pacifico, S. A.  
Ave. 16 de Septiembre No. 574, Guadalajara  
Taller y Refacciones Solorzano  
Gante No. 128, Guadalajara

MEXICO I, D. F. Asesores y Proveedores S. de R. L.  
Lorenzo Boturini No. 6  
Centro Exportador e Importador S. A.  
Av. Juarez No. 157  
Comercial de Maquinaria S. A.  
Calle Victoria No. 85  
Comercio de Maquinaria S. A.  
Fray Servando T. de Mier 345-G

\* MOTORES DE COMBUSTION INTERNA  
WISCONSIN S. A.  
Av. Juarez No. 157

MICHOACAN El Hogar Moderno S. A.  
Ave. Madero No. 287 Sur, Zamora  
Equipos Agrícolas e Industriales S. A.  
Ave. Morelos Nte. No. 978, Morelia  
Maquinaria Moderna y Agropecuaria  
Paseo del Cupatitzia No. 62-A, Uruapan  
Motores Bombas y Servicio S. A.  
Blve. Adolfo Lopez Mateos y Aldama, La Piedad  
Maquinaria Moderna, S. A.  
A. Obregon y M. Avila Camacho, Cuernavaca

MORELOS Bombas Servicio S. A.  
Zaragoza Nte. No. 621, Monterrey  
Sada Gomez S. A.  
Padre Mier No. 247 Pte., Monterrey

NUEVO LEON

**OAXACA** Implementos Agricolas e Industriales S. A.  
Czda. Madero No. 1008, Oaxaca  
Maquinaria y Refacciones de Oaxaca, S. A.  
C. M. Bustamante No. 114, Oaxaca  
Montajes y Maquinaria de Salina Cruz, S. A.  
Mazatlan No. 25, Salina Cruz

**PUEBLA** Accesorios y Suministros S. A.  
Ave. 2 Poniente No. 704-B, Puebla  
Cabrera, S. A.  
10 Oriente No. 6, Puebla  
Distribuidora de equipa Agricola S. A.  
8 Poniente No. 314, Puebla

**SAN LUIS POTOSI** Maquinaria en General S. A.  
Av. Juariz No. 340, San Luis Potosi  
Tomas Osuna M.  
Carretera Mexico Laredo y Juarez, CD. Valles

**SINALOA** Cia. Comercial del Noroeste, S. A.  
Km 5½ carretera a Navolato, Culiacan  
Ernesto Coppel Marini Sucesion  
M. Gutierrez Najera No. 57, Mazatlan  
La Rycsa  
Zaragoza No. 505, Los Mochis

**SONORA** Productos Practicos S. A.  
Miguel Aleman No. 244, Sur, CD. Obregon  
Proveedora Agricola del Pacifico S. A.  
Pesqueira No. 403 Sur, Navajoa

**TABASCO** Centro Comercial Maba, S. A. de C. V.  
Pino Suarez No. 302, Villahermosa

**TAMAULIPAS** Baleros y Bombas S. A.  
Juarez No. 311 Ote., CD. Mante  
Baleros y Retenes  
Fca. I. Madero No. 617 Ote., Rio Bravo  
Casa Automotriz del Mante  
Av. Juarez No. 118 Ote., CD. Mante  
Equipos y Tractores de Victoria S. A.  
Berriozabal y calle 8, CD. Victoria  
Ferretera del Golfo, S. A.  
Heroes del Canonero Tampico 412 Ote. Tampico

**TOLUCA** Productos Carsal  
Constituyentes 215 Ote., Toluca

**VERACRUZ** Abastecedora Electrica de Cordoba, S. A.  
Avenida 3 No. 900, Cordoba  
Fierros y Laminas S. A.  
Central Nte. y Das Ote., Poza Rica  
Maquinaria e Implementos de Jalapa  
F. Carrillo Puerto No. 34, Jalapa  
Maquinaria e Implementos de Veracruz, S. A.  
Avenida 1 No. 906, Cordoba  
Maquinaria e Implementos Rosfer S. A.  
Ave. 5 de Mayo No. 216, Veracruz  
Rafael Martinez Baron  
Zaragoza No. 309-A, Coatzacoalcas

**YUCATAN** Cia. Perforadora de Pozos de Agua S. A.  
Calle 59 No. 487, Merida

**MOROCCO**

**AGADIR** Satas  
P. O. Box 33

**ALCAZARQIVIR** Cohen & Zefri  
Route de Tanger

**CASABLANCA** \* Hamelle-Maroc  
P. O. Box 682

**FEZ** \* Hamelle-Maroc  
42, Rue Cuny

**KENITRA** Socar  
P. O. Box 82

**MECHRA BEL KSIRI** \* Hamelle-Maroc  
Rue Poeymirau

**MEKNES** \* Hamelle-Maroc  
c/o Ets. Manneret  
27, Ave. Jean Jaures

**OUIJA** Labor  
Avenue Mohammed V

**SIDI KACEM** \* Hamelle-Maroc  
Avenue Lyautey

**TETOUAN** Lu Technica  
P. O. Box 83/284

**MOZAMBIQUE (PORTUGUESE EAST AFRICA)**

**LOURENCO MARQUES** \* Santos, Marques & Silva Lda  
Rua da Electricidade 9  
(Box 166)

**NETHERLANDS**

**ROTTERDAM** \* R. S. Stokvis & Zonen N. V.  
P. O. Box 426

**NETHERLANDS ANTILLES**

**CURACAO** \* Frederik Trading Co., N. V.  
Caracasbaaiweg No. 49

**NEW ZEALAND**

**AUCKLAND** Doring Implement Supplies Limited  
**BLENHEIM** Doring Implement Supplies Limited  
**CHRISTCHURCH** Doring Implement Supplies Limited  
**GORE** Doring Implement Supplies Limited  
**HAMILTON** Doring Implement Supplies Limited  
**HASTINGS** Doring Implement Supplies Limited  
**HAWERA** Doring Implement Supplies Limited  
**NELSON** Doring Implement Supplies Limited  
**OAMARU** Doring Implement Supplies Limited  
**PALMERSTON NORTH** Doring Implement Supplies Limited  
**RANFURLY** Doring Implement Supplies Limited  
**TE PUKE** Doring Implement Supplies Limited  
**TIMARU** Doring Implement Supplies Limited  
**WELLINGTON** \* Doring Implement Supplies Ltd.  
P. O. Box 1179

**WHANGAREI** Doring Implement Supplies Limited

**NICARAGUA**

**CHINANDEGA** Nicaragua Machinery Co.  
**GRANADA** Eddie Lacayo  
**LEON** Nicaragua Machinery Company  
Sucursal de Leon

**MANAGUA** \* Nicaragua Machinery Company  
Apartado 469

**MASAYA** Arnaldo Lacayo Maison

**NORWAY**

**BERGEN** Maskin A/S K. Lund & Co.  
Strandgt 212

**OSLO** \* Maskin A/S K. Lund & Co.  
Revierstredet 3

**TROMSO** Maskin A/S K. Lund & Co.  
Skippergt 7 A

**TRONDHEIM** Maskin A/S K. Lund & Co.  
Sondregt 14

**PAKISTAN (EAST)**

**DACCA** Machinery & Spares Company, Ltd.  
214, Nawabpur Road

**PAKISTAN (WEST)**

**KARACHI** \* Butt Engineering Stores  
29, Badri Building, McLeod Road

**PANAMA**

PANAMA CITY \* Guardia & Cia, S.A.  
Ave. Justo. Arosemena Y Calle 29  
P. O. Box 481

**PARAGUAY**

ASUNCION \* Oscar S. Netto S.A.  
Caballero Eligio Ayala Mexico

**PERSIAN GULF**

BAHRAIN \* Salman A. Kaikow  
P. O. Box 80

**PERU**

LIMA \* Peruvian Trading Corp. Ltd. S.A.  
Av. Alfonso Ugarte 899  
P.O. Box 1537

**PHILIPPINE ISLANDS (MANILA)**

MAKATI, RIZAL \* Honiron Philippines, Inc.  
P.O. Box 438  
Makati Commercial Center

**PORTUGAL**

LISBON \* Joao Felix Da Silva Capucho, Limitada  
P. O. Box 2121  
113, Rua de Sao Paulo, 129

PORTO \* Joao Felix da Silva Capucho  
139 R. Mousinho da Silveira 143

**PUERTO RICO**

HATO REY \* Puerto Rico Wire Products Inc.  
Francia St. No. 509  
Mailing Address: P. O. Box 3167,  
San Juan, Puerto Rico

PONCE Southern Industrial Supplies Corp.  
44 Comercio Street  
P. O. Box 1764

**REPUBLIC OF CENTRAL AFRICA (OUBANGUI-CHARI)**

BANGUI \* Hamelle-Afrique  
P. O. Box 928

**REPUBLIC of SOUTH AFRICA**

BLOEMFONTEIN \* Barlow's (O.F.S.) Ltd  
Nuffield St. (P.O. Box 1088) Hamilton

CAPE TOWN \* Arc Engineering Cape  
Arc House  
National Paarden  
Eiland Road  
P. O. Box 4741

DURBAN \* Barlow's Electrical & Engineering Co., Ltd.  
312 Sydney Road, P.O. Box 2465

JOHANNESBURG \* Barlow's Industrial Equip. Co.,  
16-20 Wolluter St., Jeppe  
P. O. Box 33264  
Jeppestown

PIETERMARITZBURG \* Barlow's Electrical & Engineering Co.,  
208, Victoria Road  
P. O. Box 929

PORT ELIZABETH \* Barlow's (Eastern Province) Ltd  
111 Grahamstown Road  
P. O. Box 2006

WINDHOEK \* M. Pupkewitz & Sons (Pty) Ltd  
Box 140  
(Southwest Africa)

**REPUBLIC OF CHINA**

TAIWAN \* Hung-Yeh Trading Corp.  
67 Chungking So. Road  
P. O. Box 1185  
Taipei

**SAUDI ARABIA**

JEDDAH \* Mohamed Ali Maghrabi & Sons  
P. O. Box 61

**SENEGAL**

DAKAR \* Hamelle-Afrique  
P. O. Box 162

**SPAIN**

MADRID \* Vidaurreta Y Cia. S.A.  
Atocha 121

**SURINAM (NETHERLANDS GUIANA)**

PARAMARIBO \* C. Kersten & Company, N. V.  
Steenbakkerijstraat 27  
P.O. Box 1808

**SWEDEN**

STOCKHOLM \* Ingeniorsfirman T. Jutgard  
Korsbarsvagen 6-10

**SWITZERLAND**

ZURICH \* Baumaschinen AG  
Badenerstrasse 570, 8048

**THAILAND**

BANGKOK \* Thai Machinery Industry Co., Ltd.  
2640 New Petchburi Road (Extension)  
opp. Klong Tan Railway Station

**TRINIDAD**

SAN FERNANDO \* Industrial Agencies Limited  
18 Lady Hailes Ave. - P. O. Box 149

**TUNISIA**

TUNIS \* Hamelle-Afrique  
58 Ave. de Carthage

## TURKEY

ISTANBUL \* Niyazi Kiran  
P.O. Box 597, Karakoy

## SOUTHERN RHODESIA

BULAWAYO Barlow's Tractor & Equipment Co. Ltd.  
P. O. Box 1192

CHIREDDZI Barlow's Tractor & Equipment Co. Ltd.  
Chiranga Drive

SALISBURY \* Barlow's Tractor & Equipment Co. Ltd.  
P. O. Box 291, P. O. Southerton

UMTALI Barlow's Tractor & Equipment Co. Ltd.  
P. O. Box 193

## URUGUAY

BELLA UNION Waldemar Perez

MONTEVIDEO \* Storer & Cia. S.A.U.  
Mercedes 1312

SALTO Bisio & Sancristobal  
Rumi & Pereyra S.A.

SAN RAMON Melchor Diaz

## VENEZUELA

ACARIGUA Casa Roda Industrial, C. A., Avenida 15 No. 84

BARQUISIMETO Casa Roda Industrial, C. A.  
Calle 37 Edificio la Mascota Local No. 6  
Intagro, C. A., Edif. La Palma, Calle 23  
I. A. Senior & Hijo, Sucs., S. A.  
Avenida 20 No. 26-47  
Macamps, S.A., Avenida 20 No. 28 - 70  
Maquinarias Mendoza, C.A.  
Apartado Postal No. 13

CARACAS C. A. de Tractores y Maquinarias  
Estatua Sucre a Parque Artigas  
C. A. Tecnomat,  
Apartado Postal No. 108  
Drew-Bear & Sons, C.A.  
Apartado Postal No. 1089

\* Leopoldo Turco Rivas  
P. O. Box 1691  
Lorenzo Bustillos M. & Cia. Susc., C.A.  
P. O. Box 234  
Maquinarias Mendoza, C.A.  
P. O. Box 2641  
Mata Sifantes, S.A.  
Apartado Postal No. 572  
Montemayor & Cia., Suc., S.A.  
P. O. Box 164  
Oficina Tecnica Stubbins  
P. O. Box 7  
Sanchez & Cia., S.A.  
Apartado Postal No. 1006

GUANARE Casa Roda Industrial C.A.  
Avenida 1 Este  
Entre Calle 3 Norte y Plaza Bolivar

MARACAIBO Oficina Tecnica Stubbins, C.A.  
P. O. Box 162  
Rafael Mofero G. & Cia., Almacen Multiple,  
Calle 100 No. 9-70

## MARACAY

Maquinarias Mendoza, C. A.  
Avenida Bolivar No. 44 - 1 Este

PUERTO LA CRUZ Oficina Tecnica Stubbins, C.A.  
P. O. Box 4072

VALENCIA Mata Sifantes, S.A.  
Calle 91, No. 106-78

## VIETNAM

SAIGON Brownell, Lane Engineering, Ltd.  
232 Duong Trinh-Minh-The

Brownell, Lane International, Ltd.  
30 Broad Street  
New York 4, New York

## VIRGIN ISLANDS (U.S.A.)

\* Puerto Rico Wire Products Inc.  
Francia St. No. 509  
Hato Rey, Puerto Rico

## WEST GERMANY

FRANKFURT Rigona G. M. B. H.  
Siesmayerstrasse 6  
6 Frankfurt/Main

# ENGINE WARRANTY

WISCONSIN MOTOR, hereinafter referred to as "Manufacturer", warrants each new engine sold by the Manufacturer to be free from defects in material and workmanship, under normal use and service, for a period of one (1) year after the date of delivery to the original retail purchaser, and Manufacturer will, at its option, replace or repair, at one of the Manufacturer's factories, or at a point designated by the Manufacturer, any part or parts which shall appear to the satisfaction of the Manufacturer upon inspection at such point, to have been defective in material or workmanship. This Warranty does not obligate the Manufacturer to bear any transportation charges in connection with the replacement or repair of defective parts.

This Warranty shall not apply to any engine which shall have been installed or operated in a manner not recommended by the Manufacturer; nor to any engine which shall have been repaired, altered, neglected or used in any way which, in the Manufacturer's opinion, adversely affects its performance; nor to any engine in which parts not manufactured by the Manufacturer, or supplied by the Manufacturer or by one of Manufacturer's Distributors or approved Service Centers, have been used; nor to any accessories installed on the engine, where the accessory manufacturer has its own warranty; nor to normal maintenance services or replacement of normal service items.

Manufacturer reserves the right to modify, alter, and improve any engine or parts without incurring any obligation to replace any engine or parts previously sold with such modified, altered or improved engine or part.

THIS WARRANTY, AND THE MANUFACTURER'S OBLIGATION THEREUNDER, IS IN LIEU OF ALL OTHER WARRANTIES, EXPRESS, IMPLIED, OR STATUTORY, INCLUDING ANY WARRANTIES OF MERCHANTABILITY OR OF FITNESS FOR A PARTICULAR PURPOSE, and all other obligations or liabilities, including special or consequential damages or contingent liabilities arising out of the failure of any engine or part to operate properly. No person is authorized to give any other warranty or to assume any additional obligation on the Manufacturer's behalf unless made in writing and signed by an officer of the Manufacturer.

THIS MANUAL IS FOR MY WISCONSIN MODEL..... ENGINE

SPEC. No..... SERIAL No.....

THE ABOVE INFORMATION, WHICH WILL BE FOUND ON THE NAME PLATE ATTACHED TO THE AIR SHROUD OF THE ENGINE, SHOULD BE FILLED IN. YOUR PROMPT ATTENTION TO THIS MATTER WILL MAKE IT CONVENIENT FOR YOU IN THE FUTURE, AS THIS INFORMATION MUST BE GIVEN WHEN ORDERING SERVICE REPLACEMENT PARTS.

\* For Your Own Record, Do Not Cut Out and Return to Factory.

Complete Instructions and Service Parts Manual is available at a cost of \$1.50, from all Wisconsin Distributor's

## Safety Precautions

Never fill fuel tank while engine is running or hot. Avoid the possibility of spilled fuel causing a fire.

Never operate engine in a closed building unless the exhaust is piped outside. This exhaust contains carbon monoxide, a poisonous, odorless and invisible gas, which if breathed causes serious illness and possible death.

Never make adjustments on machinery while it is connected to the engine, without first removing the ignition cables from the spark plug. Turning over the machinery by hand during adjusting or cleaning might start the engine, and machinery with it, causing serious injury to the operator.

Precaution is the best insurance against an accident.

## Winter Storage

To protect the cylinder, piston, rings and valves, and keep them from rusting and sticking, a half and half mixture of kerosene and good gas engine oil, (the same grade as used in the engine crankcase) should be injected into the carburetor air intake while the engine is warm and running at moderate speed. About an eighth of a pint is necessary, or enough so that a heavy bluish smoke will appear at the exhaust. This fogging operation will leave a coating of oil on the above mentioned parts, protecting them from the atmosphere. After the engine has stopped, turn engine over slowly by means of the rope starter sheave, until flywheel key or take-off shaft key-way is up, or in the 12 o'clock position and on compression stroke. Both valves will then be closed and the piston will be on top in the cylinder bore. This will minimize rusting of the cylinder bore and help in retaining the oil fog previously injected into the engine.

Drain crankcase oil while engine is warm.

Drain tank, fuel lines and carburetor of all gasoline, to prevent accumulation of lead and gum deposits in the small passages of the carburetor.

The air cleaner should be thoroughly cleaned (remove oil from oil bath type). Air cleaner and exhaust openings should be taped or otherwise sealed off for the duration of the storage period.

The outside of the engine, including the cooling fins on the cylinder and head, should be thoroughly cleaned of all dirt and other deposits. All exposed unpainted metal parts should be coated with grease or heavy oil.

Before adding new crankcase oil the following season, drain base of condensation which may have accumulated during the storage period.

Use a new spark plug at the beginning of the next season, especially if the engine has given considerable service.

*It is highly recommended that machines be stored inside a building through the winter. If this is not possible, the engine should be protected from snow and ice by a proper covering.*

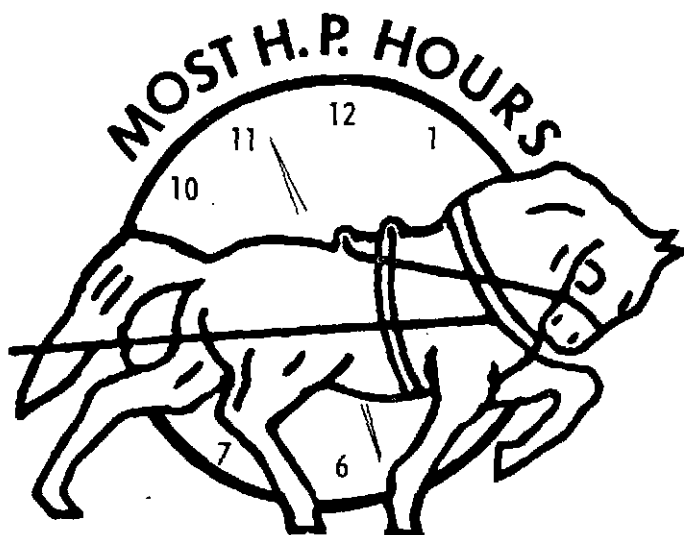

### WISCONSIN MOTOR

DIVISION OF CONTINENTAL MOTORS CORPORATION

MILWAUKEE, WISCONSIN 53246

Printed in U.S.A.  
by Wisconsin Motor